

NorDig Unified Requirements

for

Integrated Receiver Decoders

for use in

cable, satellite, terrestrial and IP-based networks

Date: 25 August 2014

1	Introduction	5
1.1	Scope	5
1.2	Document History	7
1.3	Terminology	10
1.4	Definitions	10
1.5	References	10
1.6	List of Abbreviations	15
2	General Features of the NorDig IRD	19
2.1	Introduction	19
2.2	IRD Hardware and Firmware	19
2.3	System Software and API.....	23
2.4	General Product Requirement	24
	PART A: Hardware and Firmware	26
3	The Frontend of the NorDig IRD	27
3.1	Common Features.....	27
3.2	Satellite Tuner and Demodulator.....	27
3.3	Cable Tuner and Demodulator	31
3.4	Terrestrial Tuner and Demodulator	36
3.5	IP Based Front-End	57
4	MPEG-2 Demultiplexer	59
4.1	General	59
4.2	DVB Descrambler Performance (for IRD with embedded descrambling).....	59
4.3	System Clock Recovery	59
5	Video	60
5.1	General requirements	60
5.2	Supported resolutions and frame rates	60
5.3	Up-sampling/Up-converting.....	61
5.4	Colorimetry	61
5.5	Dynamic changes in the video stream	62
5.6	AVC still picture	62
5.7	Minimum video bandwidth	63
5.8	Frame Cropping.....	63
5.9	Overscan.....	63
5.10	High Definition Video Output and Display.....	64
5.11	Down-conversion of High Definition Video for Standard Definition output.....	64
5.12	Display Format for other Aspect Ratios.....	64
5.13	Rescaling for HbbTV application.....	65
6	Audio.....	66
6.1	General	66
6.2	Audio Decoding	67
6.3	Multichannel Audio.....	70
6.4	Stereo Audio.....	70
6.5	Audio Prioritising	70
6.6	Audio Output Formats.....	73
6.7	Audio Video Synchronisation	75
6.8	Audio Output Signals	76
6.9	Dynamic Changes.....	77
6.10	Clean Audio.....	77
6.11	Supplementary Audio.....	78
6.12	IRD Internal Reference Level	80
6.13	Loudness Levels, – Dynamic Range Control and Downmixing	81
7	Teletext and Subtitling	84
7.1	General	84
7.2	EBU Teletext.....	85

7.3	DVB Subtitling.....	85
8	Interfaces and Signal Levels.....	87
8.1	Introduction	87
8.2	RF- bypass (option).....	87
8.3	Two-way Interface	87
8.4	SCART Interfaces (Option).....	87
8.5	Audio Output Interfaces (Option)	88
8.6	HDMI Interface	88
8.7	Remote Control Interface	91
9	Interfaces for Conditional Access	94
9.1	General	94
9.2	Use of the Common Interface.....	94
9.3	Use of Smart Card Reader	95
10	The System Software Update	97
10.1	General	97
10.2	Download via broadcast channels	99
10.3	Download via local interface or IP-based interface.....	102
10.4	Network Management and Provisioning	102
10.5	The System Download Mechanism via broadcast channels.....	102
10.6	CIP-CAM software updates	104
11	Performance	105
11.1	Introduction	105
11.2	Video Performance of RGB and PAL Signals	105
11.3	Audio Performance of the Decoded Digital Signal.....	105
11.4	Zapping Time for TV Services.....	106
Part B:	The system software with application	107
12	Service Information.....	108
12.1	General	108
12.2	Network Information Table (NIT).....	114
12.3	Service Description Table (SDT).....	126
12.4	Event Information Table	127
12.5	Time and Date Table and Time Offset Table.....	130
12.6	Conditional Access and Program Map Tables	131
12.7	SSU UNT Descriptors.....	136
12.8	Related Content Table (NorDig PVR only)	140
12.9	NorDig Broadcast Record List syntax (NorDig PVR only).....	143
13	Navigator.....	153
13.1	General	153
13.2	Service List.....	153
13.3	Event Schedule Guide (ESG).....	155
13.4	Service Discovery and Selection for IRDs with IP-based front-end.....	157
13.5	User Information (UI) about service components (audio and subtitling).....	158
13.6	Accessibility menus and settings.....	158
14	NorDig PVR feature requirements (NorDig PVR only)	160
14.1	Introduction - PVR	160
14.2	General - PVR	160
14.3	PVR Recording.....	164
14.4	Playback	175
15	IRD System Software and API.....	177
15.1	NorDig Basic.....	177
15.2	NorDig Hybrid	177
16	User Preferences.....	178
16.1	General	178
16.2	User Preference Settings	178

16.3	Deletion of service lists	179
16.4	Reset to factory mode.....	179
Annex A : NorDig Members and Acknowledgement		181
1	NorDig Full Members	181
2	NorDig Associated Members	181
3	Acknowledgement and support.....	181
Annex B : Background and options for IRDs with a terrestrial front-end		182
1	Terminology and Definitions for Single Frequency Networks Performance Parameters	182
2	List of DVB-T/T2 centre frequencies	185
3	Hierarchical mode reception	187
Annex C : Bootloading and Service Lists in IP-based and other networks.....		188
Annex D : Implementations Guidelines for best service selection in automatic channel search in terrestrial networks		189
Annex E : Raw carrier to noise values, $(C/N)_{RAW}$		191
Annex F : Recommendation for menu wordings and translations		192
Annex G : Guidelines for NorDig IRD audio selection		196
Annex H : Loudness levels, – Typical IDTV Audio Block diagram		199
Annex I :Examples of Signalling to be used for audio property		201
Annex J : Comparison of NorDig profiles		202
1	Introduction	202
2	Legend.....	202

1 Introduction

1.1 Scope

This document specifies a set of equipment requirements for reception of DVB-based and related services from cable, satellite and/or terrestrial broadcast networks; in addition it includes requirements for reception via IP-based networks. The specifications cover IRDs, both as separate units (set-top-boxes) and as relevant parts of integrated digital TV-sets.

The NorDig IRD technical specifications are established with the aim to ensure that IRDs in the Nordic market satisfy a common set of minimum requirements, independent of operator/service provider and transmission media.

The NorDig I specification was first issued in 1998 when the common DVB API solution had not taken specific direction and based on the technical status of that time.

The NorDig Unified Requirements include the profiles; **Basic TV** and **Hybrid**.

The **NorDig Basic profile** corresponds to basic requirements for digital broadcasting, services that do not depend on enhancements by applications or interaction. This profile is a subset of the Enhanced Profile.

The **NorDig Hybrid profile** covers the NorDig requirements for enhanced services depend on a standardized API, based on the HbbTV v1.5 specification ETSI TS 102 796 [30].

The NorDig Unified specification text relates to all profiles. All requirements specified in this document are mandatory unless otherwise specified.

Figure 1.1 indicates the relationship between the NorDig profiles and the various building blocks.

In addition to the different versions of the NorDig IRDs above, the NorDig IRDs may include support for recording services and later playback of them, then becoming a NorDig PVR IRD (or simply a NorDig PVR). The basic PVR functionality that is specified for NorDig does not require support from the API (HbbTV).

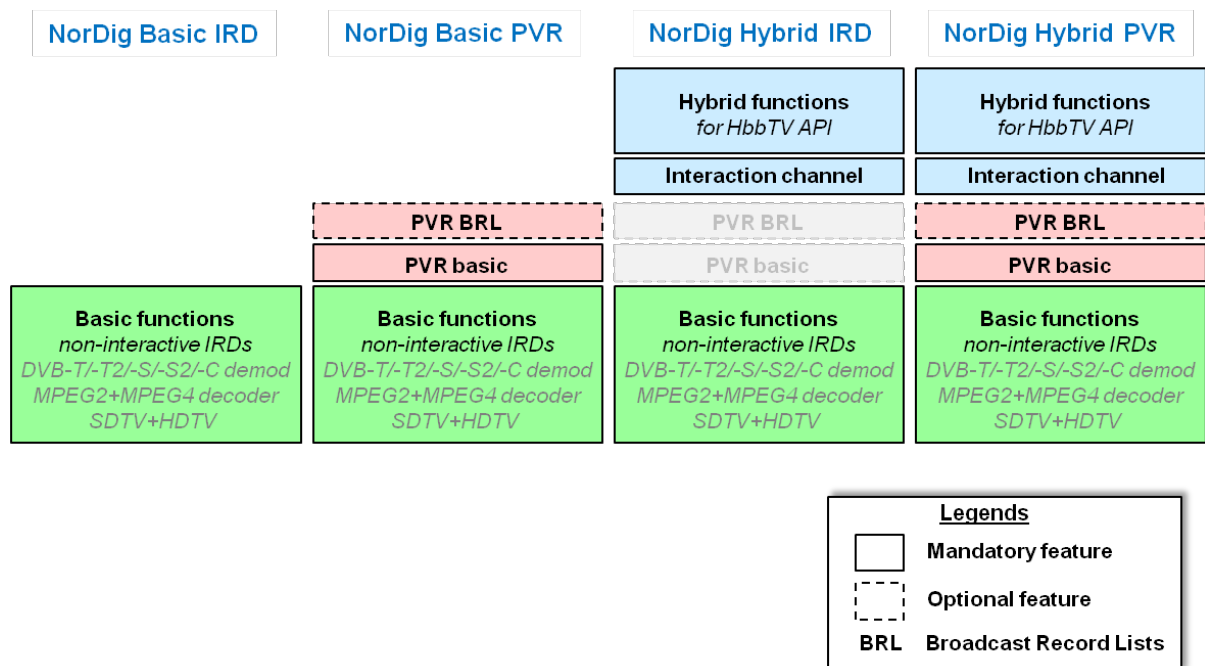

Figure 1.1 The NorDig profiles and the main building blocks.

The NorDig Unified Requirements were updated in 2003, in 2004/2005 (Version 1.0.2) and in 2006 (version 1.0.3) when the IPTV-Addendum was merged into the text; in addition some new requirements were introduced as mandatory after a specified grace period.

Version 2.0 was established in 2008 and includes the NorDig HDTV-Addendum.

Version 2.1 includes updates to version 2.0 up to July 2009 and the addition of basic requirements for NorDig PVR, which were available as an Addendum to NorDig Unified 2.0.

Version 2.2 includes updates to version 2.1 up to July 2010, including requirements for an enhanced terrestrial front-end (T2) and updates to the PVR requirements. All NorDig IRDs shall now support advanced codecs. The T2-front-end is mandatory for IRDs that target NorDig compliant signals based on the DVB-T2 specification.

The version 2.3 includes updates to version 2.2 up to May 2012, including updates to the terrestrial front-end (T2), the PVR and audio requirements. The version 2.3 included as an Addendum HbbTV as NorDig's new API (replacing MHP)

This version 2.4 includes updates to version 2.3 up to November 2012. The main changes are inclusion of HbbTV requirements and removal of MPEG2 only IRD alternative "M2 Level". All NorDig IRDs shall support both MPEG2 and MPEG4.

It should be noted that compliance with the NorDig requirements will require full compliance with at least one of the specified profiles Basic or Hybrid.

NorDig has also specified NorDig Rules of Operation for NorDig compliant networks [63], and the Unified NorDig Test Specifications [64], in order to verify compliance with the NorDig Unified Requirements for new IRDs. These Rules of Operation and Test Specifications cover all NorDig profiles.

It should be noted that the **NorDig Rules of Operation** [63] and the **NorDig Test Specifications** [64] may provide additional detail to the specified requirements (in this specification), and should be used when additional background is needed in order to interpret the specified requirements.

The specifications of the NorDig IRDs are divided into two parts.

- Part A: Hardware and firmware
- Part B: The Software system and Application Programming Interfaces (API) as relevant.

The specification parts A and B outline the desired hardware and software architectures. Based on this framework the mandatory interfaces, functionality and performance requirements of the IRD are specified. Part B deals also with requirements to the operating system. Optional requirements are specified for recommended, but not mandatory functions.

The NorDig group represents broadcasters, operators and service providers in the Nordic countries, see Annex A.

The various members of NorDig are independent of each other but intend to transmit to IRDs that satisfy the specified common requirements. In order to ensure compliance with the NorDig requirements, the NorDig IRDs will be subject to a set of verification tests, based on **NorDig Test Specifications** [64].

1.2 Document History

Version	Date	Comments
NorDig I ver. 1.1	12.05.98	This is the first approved version of the complete NorDig I specification
NorDig I ver. 1.3	01.03.01	Some editorial changes are performed, to bring the text in line with NorDig II (ver. 0.9). Some requirements are relaxed, when relaxed in NorDig II (ver. 0.9). Some new optional requirements are introduced in NorDig I that are mandatory requirements to NorDig II. References are updated to reflect the present status of the original references.
NorDig I ver. 1.4	01.10.2002	This update of the NorDig I specification is contained in the NorDig Unified, ver 1.0, see below. This update includes relaxation of some specifications, partly due to experience from testing of IRDs, but mainly in order to keep the same minimum requirements for non-interactive services as for the Basic TV profile. Some text is modified, in order to improve clarity and unify text for identical requirements in the NorDig I and NorDig II specifications. Furthermore, some additional parameters/descriptors are specified in sections 12 and 13, in order to bring the specification in line with NorDig II, ver.1.1. Some requirements will be increased to mandatory after a grace period; these increases are due to technical progress and satisfied by most IRDs sold in 2002.
NorDig II ver. 0.9	08.06.2000	This is the first approved version of the NorDig II specification, based on DVB-MHP-ver.1.0 until ver.1.1 becomes available
NorDig II ver. 1.0	13.06.2001	This version includes an update to reflect the changes in DVB-MHP-ver1.1 compared to MHP-ver1.0, and some clarifications of the text. Furthermore, some additional parameters/descriptors are specified in sections 12 and 13 and the text is modified for better clarity. In addition some relaxations in line with the NorDig I ver. 1.3 specification have been included.
NorDig II ver. 1.1	01.10.2002	This update of the NorDig II specification is contained in the NorDig Unified, ver 1.0, see below. This update includes relaxation of some requirements, partly due to experience from testing of IRDs, but mainly in order to keep the same minimum requirements for non-interactive services as for the Basic TV profile. Some text is modified, in order to improve clarity. Some requirements, mainly related to the terrestrial front-end will be increased to mandatory after a grace period; these increases are due to technical progress and operational experience.
NorDig Basic TV	01.10.2002	This is the first approved version of the NorDig Basic TV profile. The specification text is based on NorDig II, ver 1.0 and harmonised with NorDig II, ver. 1.1 when relevant. The specification text is a subset of the NorDig Unified, ver 1.0; see below.
NorDig Internet	01.10.2002	This is the first approved version of the NorDig Internet Access profile. It is based on the specification text for NorDig II, ver. 1.1, with necessary additions to include the DVB-MHP-Internet Access profile. The specification text is included in the NorDig Unified, ver 1.0; see below.
NorDig Enhanced	16.10.2002	This is the first approved version of the NorDig Enhanced profile. The specification text is based on NorDig II, ver 1.1 and harmonised with NorDig Basic TV when relevant. The specification text is a subset of the NorDig Unified, ver 1.0; see below.
NorDig Unified, ver. 1.0	16.10.2002	This is the first approved version of the NorDig Unified requirements for IRDs and includes requirements for all NorDig profiles; including Basic, Enhanced, NorDig I, Interactive (NorDig II) and Internet.

NorDig Unified, ver. 1.0.1	01.07.2003	This version includes updates of requirements that were introduced in version 1.0 with a grace period, and some new requirements with corresponding grace periods, mainly related to the terrestrial front-end, SI (chapters 12 and 13) and the user interface (chapters 16 and 17). Some text is modified in order to improve clarity.
NorDig Unified, ver. 1.0.2	30.4.2005	This version includes updates of requirements that were introduced in version 1.0.1 with a grace period, some new requirements and modifications of the mandatory CA-requirements (see section 15.1). The specification is also expanded to include requirements for IP-front-ends (provided as a separate addendum to this specification) and requirements for terrestrial front-ends in the VHF-band.
NorDig Unified, ver. 1.0.3	28.2.2007	This version includes updates of requirements that were introduced in version 1.0.2 with a grace period, while the NorDig I profile and requirements for Controllers and Memory are removed. Requirements for the IP based front-end are included (previously available as a separate addendum).
NorDig Unified ver. 2.0	01.07.2008	This version includes NorDig Unified ver 1.0.3 plus NorDig HDTV-Addendum ver 1.0 (previously available as a separate document). In addition it includes some updates to the existing requirements and introduction of some new requirements with a grace period. Some editorial changes are made, including change of chapter order compared with earlier versions.
NorDig Unified ver 2.1	01.07.2009	This version includes NorDig Unified ver 2.0 plus the Additional requirements for NorDig PVR (previously available as a separate document). In addition it includes some updates to the existing requirements, including enhancements to the terrestrial and cable front-ends. Minimum requirements for reception of DVB-T2 signals are issued as an Addendum to this specification. New requirements are introduced with a grace period.
NorDig Unified ver 2.2	01.07.2010	This version includes NorDig Unified ver 2.1 plus the Additional Requirements for NorDig T2 IRDs (previously available as a separate document). In addition it includes some updates to the existing requirements, including enhancements to the front-ends and the PVR functions. All IRDs shall now support the MPEG 4-video compression. New requirements are introduced with a grace period
NorDig Unified ver 2.2.1	1.11.2010	This version includes NorDig Unified ver. 2.2 requirements and corrections to the DVB-T2 FE and audio requirements. Also some references are updated.
NorDig Unified ver 2.3	15.5.2012	This version includes NorDig Unified ver 2.2 plus additional requirement for the PVR functionality and new requirements for the Audio functionality.

NorDig Unified ver 2.4	16.01.2013	<p>This version 2.4 includes updates to version 2.3 up to November 2012, including updates to the API (HbbTV), video and audio requirements. Most important changes are:</p> <ul style="list-style-type: none"> - General: removal of M2 and M4 Levels, all NorDig IRDs shall now support MPEG2 and MPEG4. - General: DVB-T2, ETSI specification changed from v1.1.1 to v1.2.1 - General: HbbTV requirement, changed from v1.0 (ETSI 102 796 v1.1.1) to v1.5 (ETSI 102 796 v1.2.1) - Ch 3.4.10 Terrestrial – inclusion of immunity requirement against other signals, 800MHz LTE signals. - Ch 5 video – update and restructure of requirements - Ch 6 audio – update audio priority handling and supplementary audio - Ch 7 Teletext and Subtitling – coexist handling for subtitling and HbbTV - Ch 8.4 SCART – will become optional from 2014 - Ch 8.6 HDMI – update of HDMI requirements - Ch 8.7 remote control – updates related to HbbTV - Ch 12.1 SI – inclusion of Country and Language codes - Ch 12.6 SI PMT – updates for descriptors related to audio - Ch 14 PVR – updates Full service recording and Playback related to HbbTV - Ch 15.2 API – updated for HbbTV v1.5 - Ch 16.3 User preference settings – updates related to HbbTV and Supplementary Audio <p>Annex I – new annex for examples of Signalling to be used for audio property</p>
NorDig Unified ver 2.5	07.07.2014	<p>This version 2.5 includes updates of version 2.4 and the most important changes are:</p> <ul style="list-style-type: none"> - RF connector, change of reference old IEC 60169-2 to IEC 61169-2. - Ch 3.4.7 terrestrial IRDs with RF bypass shall support control of gain - Ch 3.4 Immunity to “analogue” (PAL) signals, requirements removed - Ch 6 restructure of text and sub chapters - Ch 6.2.3 inclusion of DRC Presentation mode according to DVB/ESTI - Ch 6.5 Audio prioritising, change of audio priority from language highest priority to instead audio type highest priority. - 6.14 Loudness Levels, inclusion of DRC presentation mode 1 and 2 according to DVB ETSI TS 101 154. - Ch 7.1 Teletext and Subtitling, only display subtitling matching preferences and handling of temporary settings. - Ch 7.1 Teletext and Subtitling, handling of HbbTV Digital Teletext and EBU Teletext. NorDig Hybrids support toggling functions in TEXT key. - Ch 9 Conditional Access, change from CI+ v1.2 to CI+ v1.3. - Ch 10 SSU, complete restructure of text. Opens for more implementation alternatives. - Ch 11.4 zapping time, update of requirements (removal of zapping to/from analogue services). - Ch 12 SI, NorDig Logical Channel Descriptor version 1 changed back to mandatory. - Ch 13.5 (new) User information about service components - Ch 13.6 (new) Accessibility menus and settings - Ch 15.2 API HbbTV, add requirements on testing according with HbbTV test suits - Ch 16.1 Stored preferences, chapter restructured and updated. User preference requirements related to supplementary audio moved from 6.11 to 16.1.3.1. - Annex B Terrestrial IRDs and definition of SFN, correction of formula.

NorDig Unified ver 2.5.1	25.08.2014	<p>“Typo” corrections of the version 2.5 includes:</p> <ul style="list-style-type: none"> - Ch 3.4.10.7, important correction for second bullet - Ch 6.2, first sentence removal of duplication text. - Ch 6.5.1, correction of time for grace period. - Ch 11.3, added missing grace period for new mandatory requirements. - Ch 13.5, added missing grace period for new mandatory requirements.
--------------------------	------------	---

1.3 Terminology

Shall (Mandatory) This word means that the item is mandatory.

Should (Recommended) This word means that this item is not mandatory, but is highly recommended.

1.4 Definitions

NorDig Basic

The NorDig Basic IRDs (hereafter denoted NorDig Basic) consist of a user terminal, including all possible low to high functionality implementations and its associated peripherals. NorDig Basic is specified as a subset of this unified NorDig-specification.

NorDig Hybrid

The NorDig Hybrid IRDs (hereafter denoted NorDig Hybrid) consist of a user terminal, including all possible low to high functionality implementations and its associated peripherals.

Integrated Receiver Decoder (IRD):

Set-top-box (STB) or relevant parts of integrated digital TV (iDTV)-set.

NorDig PVR:

The NorDig IRD with the capability to record to internal media (for example a built-in hard disk drive) or removable media (for example a DVD or Blu-ray disk). The NorDig PVR (Personal Video Recorder) shall satisfy all requirements specified for a NorDig IRD, unless stated otherwise.

NorDig IRD-T and NorDig IRD-T2:

The NorDig IRD with a front-end that is capable of receiving DVB-T (NorDig IRD-T) or DVB-T and DVB-T2 signals (NorDig IRD-T2).

1.5 References

- | | |
|-----------------------------|---|
| [1] Bluetooth 2.0 | Specification of the Bluetooth System, 4 November 2004, Bluetooth SIG. |
| [2] CEA-770.3 | Consumer Electronics Association (CEA): Standard Definition TV Analog Component Video Interface, CEA -770.2C, November 2001. www.ce.org/Standards . |
| [3] CEA 861-D | Consumer Electronics Association (CEA): A DTV Profile for Uncompressed High Speed Digital Interfaces, July 18, 2006 |
| [4] DVB A 011 | Common Scrambling Algorithm. DVB Blue Book A011. |
| [5] Digital Europe HD Ready | “HD ready” Minimum Requirements, www.digitaleurope.org |

- [6] EN 50049-1 Domestic and similar electronic equipment interconnection requirements: Peritelevision Connector
- [7] EN 60728 and 50083-9 Cenelec EN 60728-1, Cable networks for television signals, sound signals and interactive services - Part 1: System performance of forward paths.
Cenelec 50083-9, Cabled distribution systems for television, sound and interactive multimedia signals – Part 9: Interfaces for CATV/SMATV headends and similar professional equipment for DVB/MPEG-2 transport streams.
- [8] EN 50157-2-1 Domestic and similar equipment interconnection requirements: AV.link-Part 2-1: Signal quality matching and automatic selection of source devices.
- [9] EN 50221 Common Interface for Conditional Access and other Digital Video Broadcasting Decoder Applications.
- [10] EN 50494 Satellite signal distribution over a single coaxial cable in single dwelling installations
- [11] EN 55013 Limits and methods of measurements of radio disturbance characteristics of broadcast receive equipment and associated equipment
- [12] EN 61319-1 Interconnections of satellite receiving equipment – Part 1: Europe.
- [13] ETSI EN 300 421 v1.1.2 Digital Video Broadcasting (DVB): Digital broadcasting systems for television, sound and data services: Framing structure, channel coding and modulation for 11/12 GHz Satellite services. (DVB-S)
- [14] ETSI EN 300 429 v1.2.1 Digital Video Broadcasting (DVB): Digital Broadcasting Systems for Television, Sound and Data Services; Framing Structure, Channel Coding and Modulation for Cable Systems.
- [15] ETSI EN 300 468 v1.11.1 Digital Video Broadcasting (DVB): Digital broadcasting systems for television, sound and data services: Specification for Service Information (SI) in Digital Video Broadcasting (DVB) systems
- [16] ETSI EN 300 472 v1.3.1 Digital Video Broadcasting (DVB): Digital Broadcasting Systems for Television, Sound and Data Services; Specification for Conveying ITU-R System B Teletext in Digital Video Broadcasting (DVB) Bitstreams.
- [17] ETSI EN 300 473 v1.1.2 Digital Satellite Master Antenna Television Distribution System (SMATV).
- [18] ETSI EN 300 706 V1.2.1 Digital Video Broadcasting (DVB): Enhanced Teletext specification
- [19] ETSI EN 300 743 v1.3.1 Digital Video Broadcasting (DVB): DVB Subtitling Systems.
- [20] ETSI EN 300 744 v1.6.1 Digital Video Broadcasting (DVB); DVB Framing structure, channel coding and modulation for digital terrestrial television.
- [21] ETSI EN 302 755 v1.2.1 Frame structure channel coding and modulation for a second generation digital terrestrial television broadcasting system (DVB-T2).

- [22] ETSI EN 302 307 v1.2.1 Digital Video Broadcasting (DVB): Second generation framing structure, channel coding and modulation systems for Broadcasting, Interactive Services, News Gathering and other broadband satellite applications (2009-08). (DVB-S2)
- [23] ETSI ETR 162 Digital Video Broadcasting (DVB); Allocation of Service Information (SI) codes for DVB systems
- [24] ETSI ETR 289 Digital Video Broadcasting (DVB); Support for use of scrambling and Conditional Access within digital broadcasting systems.
- [25] HbbTV Test Suite HbbTV Test Suite v0.9 (already available, which includes tests for up to HbbTV v1.0 features, i.e. ETSI TS102796 v1.1.1) and when available replaced by HbbTV Test Suite v1.0 (which includes tests for up to HbbTV v1.5 features, i.e. ETSI TS 102 796 v1.2.1)
- [26] ETSI TR 101 202 V1.2.1 Digital Video Broadcasting (DVB); Implementation guidelines for Data Broadcasting
- [27] ETSI TR 101 211 V1.9.1 Digital Broadcasting Systems for Television, Sound and Data Services; Guidelines on the Implementation and Usage of DVB Service Information.
- [28] ETSI TS 101 154 V1.11.1 Digital Video Broadcasting (DVB); Implementation Guidelines for the use of MPEG-2 Systems, Video and Audio in Satellite Cable and Terrestrial Broadcasting Applications; 2012-11.
- [29] ETSI ES 102 796 V1.2.1 Hybrid Broadcast Broadband TV (HbbTV), (referring to HbbTV version 1.5 functionality)
- [30] ETSI TS 102 006 V1.3.2 DVB-Data: Data download specification
- [31] ETSI TS 102 034 V1.4.1 Digital Video Broadcasting (DVB); Transport of MPEG-2 Based DVB Services over IP based Networks
- [32] ETSI TS 102 114 V1.2.1 ETSI Technical Sepcification (TS): DTS coherent acoustics; Core and extensions; 2002-12
- [33] ETSI TS 102 201 V1.2.1 Digital Video Broadcasting (DVB); Interfaces for DVB Integrated Receiver Decoder (DVB-IRD)
- [34] ETSI TS 102 323 V1.4.1 Digital Video Broadcasting (DVB); Carriage and signalling of TV-Anytime information in DVB transport streams, 2010-01
- [35] ETSI TS 102 366 V.1.2.1 ETSI Technical Specification (TS): Digital Audio Compression (AC-3, Enhanced AC-3) Standard, August 2008
- [36] ETSI TS 102 822-4 V1.5.1 Broadcast and On-line Services: Search, select, and rightful use of content on personal storage systems (“TV-anytime”); Part4: Phase 1 – Content referencing
- [37] HDCP Consumer Electronics Association (CEA): Intel: **HDCP**, “High-Bandwidth Digital Content Protection System”, rev. 1.3, December 21, 2006. (Note: on DVI HDCP rev. 1.0 or rev. 1.1 will apply.)
- [38] HDMI HDMI Licensing, LLC: **HDMI** , “High- Definition Multimedia Interface”, rev. 1.4b, October 11th, 2011

- [39] IEC 61169-2 Radio-frequency connectors – Part 2: Sectional specification – Radio frequency coaxial connectors of type 9,52.
- [40] ISO/IEC 61169-24 (ISO 169-24) Radio-frequency connectors – Part 24: Radio-frequency coaxial connectors with screw coupling, typically for use in 75 Ω cable distribution systems (Type F).
- [41] IEC 60603-14 Connectors for frequencies below 3 MHz for use with printed boards – Part 14: Detail specification for circular connectors for low-frequency audio and video applications such as audio, video and audio-visual equipment.
- [42] IEC 60958 Digital audio interface – Part 3: Consumer applications.
- [43] IEC 61937 Digital audio – Interface for non-linear PCM encoded audio bitstreams applying IEC 60958 [42].
- [44] IEEE 802.11 The Working Group for Wireless Local Area Networks (WLANs).
- [45] IEEE 802.3 IEEE Standard for Information technology-Telecommunications and information exchange between systems-Local and metropolitan area networks-Specific requirements Part 3: Carrier Sense Multiple Access with Collision Detection (CSMA/CD) Access Method and Physical Layer Specifications
- [46] IETF RFC 2131 Dynamic Host Configuration Protocol, March 1997
- [47] IETF RFC 2132 DHCP Options and BOOTP Vendor Extensions, March 1997
- [48] IETF RFC 3203 DHCP reconfigure extension, December 2001
- [49] ISO 3166 – Part 1-3 Codes for the representation of names of countries and their subdivisions:
 Part 1: Country codes, 1997
 Part 2: Country subdivision code, 1998
 Part 3: Code for formerly used names of countries, 1999
- [50] ISO 8859-1 Information technology – 8-bit single-byte coded graphic character sets – Part 1: Latin alphabet No. 1, 1998
- [51] ISO/IEC 11172-3 ISO/IEC: Information technology – Coding of moving pictures and associated audio for digital storage media at up to about 1,5 Mbit/s – Part 3: Audio
- [52] ISO/IEC 13818 – 1 Information Technology – Generic Coding of Moving Pictures and Associated Audio Information. Part 1: Systems. ISO/IEC International Standard IS 13818.
- [53] ISO/IEC 13818-2 Information technology – Generic coding of moving pictures and associated audio information: Video, ISO/IEC International Standard IS 13818
- [54] ISO/IEC 13818 – 3 Information Technology – Generic Coding of Moving Pictures and Associated Audio Information. Part 3: Audio. ISO/IEC International Standard IS 13818.

- [55] ISO/IEC 14496-3 ISO/IEC: Information technology – Coding of audio-visual objects – Part 3: Audio, 2005
- [56] ISO/IEC 14496-10 ISO/IEC: Information technology — Coding of audio visual objects — Part 10:Advanced Video Coding (MPEG-4 AAD and MPEG-4 HE-AAC), December 15, 2005
- [57] ISO/IEC 60958-3 Ed.3.0 ISO/IEC: Digital audio interface – Part 3: Consumer applications, May 25, 2006
- [58] ISO/IEC 7816, 1-3 Identification cards – Integrated circuit cards with contacts, Parts 1-3. ISO/IEC International Standard IS 7816.
- [59] ITU-J.122 (EuroDocsis 2.0): Second-generation Transmission Systems for Interactive Cable Television Services – IP Cable Modems.
- [60] ITU-J.222.1 (EuroDocsis 3.0): Third-generation Transmission Systems for Interactive Cable Television Services – IP Cable Modems: Physical Layer Specifications (Annex B)
- [61] ITU/R Report 624-4 ITU-R Report 624-4:1990, Characteristics of Television Systems.
- [62] ITU-R BT.653-3 ITU-R Recommendation BT653-2:1993, Teletext systems.
- [63] NorDig RoO
a) NorDig Rules of Operation, ver 1.0, November , 2004
b) NorDig Rules of Operation, ver 2.2. (Not yet available)
- [64] NorDig Test
a) Unified NorDig Test Specification, ver. 2.0. July 2008.
b) Unified NorDig Test Specification, ver. 2.2, (Not yet available)
- [65] Universal Serial Bus Universal Serial Bus (USB) Specification, Revision 2.0, April 27, 2000.
- [66] CI Plus Specification
CI Plus Specification.
Content Security Extensions to the Common Interface.
Version 1.3.1 (2011-09), from, CI Plus LLP
- [67] UK DTG D-Book Digital Terrestrial Television (DTG), Requirements for interoperability, The D-Book 7 Part A, Version 1, March 2011
- [68] ETSI TS 102 831 v1.1.1 Implementation guidelines for a second generation digital terrestrial television broadcasting system (DVB-T2)
- [69] ETSI TS 102 822-3-1 v1.6.1 Broadcast and On-line Services: Search, select, and rightful use of content on personal storage systems ("TV-Anytime"); Part 3: Metadata; Sub-part 1: Phase 1 - Metadata schemas. Version 1.6.1 (2010-07)
- [70] ISO 639-2 Codes for the Representation of Names of Languages Part 2: Alpha-3 Code
- [71] ETSI TS 102 822-3-2 v1.6.1 Broadcast and On-line Services: Search, select, and rightful use of content on personal storage systems ("TV-Anytime"); Part 3: Metadata; Sub-part 2: System aspects in a uni-directional environment. Version 1.6.1 (2010-07)
- [72] ETSI TS 102 851 v1.2.1 Digital Video Broadcasting (DVB); Uniform Resource Identifiers (URI) for DVB Systems. Draft version 1.2.1 until it becomes official release.

[73] EBU, R-95	EBU Recommendation R 95, Recommendation for Safe areas for 16:9 television production
[74] EBU R128	EBU Recommendation R 128, Loudness normalisation and permitted maximum level of audio signals, August 2011.
[75] EBU TECH 3344	EBU – TECH 3344, Practical guidelines for distribution systems in accordance with EBU R 128, (Supplementary information for EBU R 128), version 1.1, October 2011.
[76] EBU R68	EBU Technical Recommendation R68-2000, Alignment level in digital audio production equipment and in digital audio recorders, revised year 2000.
[77] EBU TECH 3341	EBU – TECH 3341, Loudness Metering: ‘EBU Mode’ metering to supplement loudness normalisation in accordance with EBU R 128, (Supplementary information for R 128) , August 2011.
[78] ITU-R BS.1770-2	ITU Recommendation ITU-R BS.1770-2 (march 2011), Algorithms to measure audio programme loudness and true-peak audio level
[79] ITU-R BS.1771	ITU Recommendation ITU-R BS.1771, Requirements for loudness and true-peak indicating meters
[80] IEC 62731	IEC 6273, edition 1.0 (2013-01-29), Text-to-speech for television - General requirements.
[81] HbbTV test specification	Test Specification for HbbTV Version 1.2.1 (latest version)

1.6 List of Abbreviations

0b	values written in binary (ie with base 2)
0x	values written in hexadecimal (ie with base 16)
AAC	Advanced Audio Codec
AAC-LC	Advanced Audio Codec Low Complexity
AC-3	Audio Codec 3
ACE	Active Constellation Extension
AFC	Automatic Frequency Control
AFD	Active Format Descriptor
AFNOR	Association Francaise de Normalisation
API	Application Programming Interface
ARC	Audio Return Channel (regarding HDMI interface)
AV	Audio (and) Video
BAT	Bouquet Association Table
BCD	Binary Coded Decimal
BDR	Broadcast Discovery Record (part of SD&S)
BER	Bit Error Ratio
BOOTP	Bootstrap Protocol
bslbf	bit string, left bit first
C/N	Carrier to Noise ratio
CA	Conditional Access
CAM	Conditional Access Module
CAT	Conditional Access Table
CATV	Community Antenna Television

CEA	Consumer Electronics Association (North American Association)
CENELEC	Comité Européen de Normalisation Electrotechnique
CI	Common Interface
CID	Content Identifier descriptor
CIF	Common Intermediate Format
CI- CAM	CA-module that complies with the basic Common Interface specification [9]
CIP- CAM	CA-module that complies with the Common Interface Plus specification [66]
CRC	Cyclic Redundancy Check
CRID	Content Reference Identifier
CSO	Composite Second Order
CTB	Composite Triple Beat
CVBS	Composite Video Baseband Signal
D/A	Digital-to-Analogue converter
DAD	Default Authority Descriptor
DAVIC	Digital Audio-Visual Council
dB	decibel
dBFS	dB (relative to) Full Scale
DDS	Display definition segment
DDWG	Digital Display Working Group
DECT	Digital Enhanced Cordless Telecommunications
DHCP	Dynamic Host Configuration Protocol
DSB	Double SideBand
DSM-CC	Digital Storage Media Command and Control
DTS	Digital Theater System (audio codec)
DVB	Digital Video Broadcasting
DVB-C	Digital Video Broadcasting – Cable
DVB-CAM	CA-module that complies with the DVB Common Interface specification
DVB-data	Digital Video Broadcasting – Data Broadcasting
DVB-S	Digital Video Broadcasting – Satellite
DVB-T	DVB-Terrestrial
E-AC-3	Enhanced Audio Codec 3
E-EDID	Enhanced Extended Display Identification Data (regarding HDMI interface)
EBU	European Broadcasting Union
ECCA	European Cable Communications Association
ECL	EuroCableLabs, technical cell of ECCA
EICTA	European Information & Communications Technology Industry Association
EIT	Event Information Table
EITp/f	Event Information Table, present/following tables
EITsch	Event Information Table, schedule tables
EITp	Event Information Table, present table/section of EITp/f
EITf	Event Information Table, following table/section of EITp/f
EPT	Effective Protection Target
EPG	Electronic Program Guide (based on API)
ESG	Event Schedule Guide (without any API)
FEF	Future Extension Frame
FFT	Fast Fourier Transform
GAP	Generic Access Protocol
GOP	Group Of Pictures
GPRS	General Packet Radio System
GS	Generic Stream
GSM	Group Special Mobile
HbbTV	Hybrid Broadcast Broadband TV
HDCP	High-bandwidth Digital Content Protection

HDMI	High-Definition Multimedia Interface
HDMI ARC	HDMI Audio Return Channel
HDTV	High Definition Television
HE-AAC	High Efficiency Advanced Audio Codec
HTTP	HyperText Transfer Protocol
iDTV	integrated Digital TV (IRD with display)
IEC	International Electrotechnical Commission
IEEE	Institute for Electrical and Electronic Engineers
IEFT	Internet Engineering Task Force
IGMP	Internet Group Management Protocol
INA	Interactive Network Adapter
IP	Internet Protocol
IRD	Integrated Receiver Decoder
IMI	Instant Metadata Identifier
ISO	International Organisation for Standardisation
JTC	Joint Technical Committee
LCD	Logical Channel Descriptor
LCN	Logical Channel Number
LU	Loudness Units
LUFS	Loudness Units (relative to) Full Scale
L-PCM	Linear Pulse Code Modulation
MAC	Medium Access Control
MPEG	Moving Pictures Expert Group
MPTS	Multi Programme Transport Stream
MTU	Maximum Transfer Unit
NEM	Network Element Management
NIC	Network Interface Card
NIT	Network Information Table
NT	Network Termination in general
NVOD	Near Video On Demand
OSD	On Screen Display
PAL	Phase Alternating Line
PAPR	Peak-to-Average-Power Ratio
PAT	Program Association Table
PCM	Pulse Code Modulation
PLP	Physical Layer Pipe
PID	Packet Identifier
PMT	Program Map Table
PSI	Program Specific Information
PSTN	Public Switched Telephone Network
PCR	Programme Clock Referance
PVR	Personal Video Recorder, (same as PDR, Personal Digital Recorder, or DVR)
QAM	Quadrature Amplitude Modulation
QCIF	Quarter Common Intermediate Format
QEF	Quasi Error Free
QoS	Quality of Service
QPSK	Quaternary Phase Shift Keying
RF	Radio Frequency
RFC	Request For Comments
RMS	Root Mean Square
RoO	Rules of Operation
rpchof	remainder polynomial coefficients, highest order first
RS	Reed-Solomon
RST	Running Status Table

RTCP	Real-Time Transport Control Protocol
RTP	Real-Time Transport Protocol
RTSP	Real Time Streaming Protocol
S/PDIF	Sony Philips Digital Interface (for digital audio)
SAP	Session Announcement Protocol
SBR	Spectral Band Replication (regarding HE-AAC audio)
SCART	Syndicat des Constructeurs d'Appareils Radiorécepteurs et Téléviseurs (video/audio interface)
SD&S	Service Discovery and Selection
SDT	Service Description Table
SDTV	Standard Definition Television
SFN	Single Frequency Network
SI	Service Information
SMATV	Satellite Master Antenna Television
Sntp	Simple Network Time Protocol
SPTS	Single Programme Transport Stream
ST	Stuffing Table
STB	Set-top box (IRD without display)
SW	Software
TCP	Transmission Control Protocol
TDT	Time and Date Table
TFS	Time Frequency Slicing
TFTP	Tunnelling File Transfer Protocol
TOT	Time Offset Table
TPS	Transmission Parameter Signalling
TRS	Tip Ring Sleeve
TR	Tone Reservation
TS	Transport Stream
TV	Television
TVA	TV Anytime
UHF	Ultra-High Frequency
uimsbf	unsigned integer most significant bit first
UTC	Universal Time, Co-ordinated
VCR	Video Cassette Recorder
VHF	Very-High Frequency
VHS	Video Home System
VoIP	Voice over IP
VPN	Virtual Private Network
VSB	Vestigial SideBand
xDSL	x Digital Subscriber Line
XML	Extensible Markup Language

2 General Features of the NorDig IRD

2.1 Introduction

This chapter describes the overall structure of the NorDig IRD specification. The detailed requirements are specified in the chapters 3 – 16, except for general product requirements that are specified in section 2.4.

The IRD implements the services by a combination of hardware and software solutions. The IRD may correspond to a decoder (STB) or an integrated digital TV-set (iDTV), including a display. The main functional blocks are shown in Figure 2.1.

The IRD includes a bootloader as firmware. The bootloader can upgrade all resident system-software and application software in the IRD by new software loaded either via the distribution channel or locally.

The software solution is only restricted by the hardware programming interface, i.e. the hardware functionality, capacity and performance.

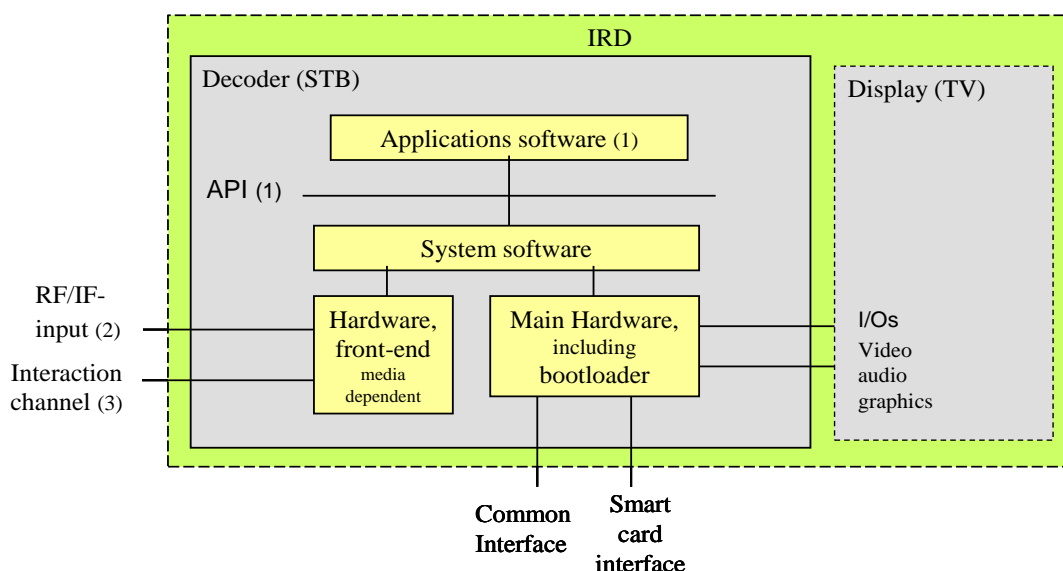

- 1: Not relevant for Basic Profile
- 2: Not required for IRDs with IP based front-end
- 3: Not relevant for Basic IRDs without IP-based front-end

Figure 2.1 Basic IRD architecture

The IRD will be provided with an installed front-end, with a cable or satellite or terrestrial Tuner & Demodulator, and/or a front-end for IP-based networks, a Common Interface and/or a Smart Card Interface. The IP-based interface may be used for reception of broadcast signals and as an input/output for the interaction channel (not relevant for Basic IRDs), these and other external interfaces are shown in Figure 2.2.

The user shall be able to access the services from all the tuners by means of the remote control.

2.2 IRD Hardware and Firmware

2.2.1 Overview

The IRD hardware and firmware consists of a number of functional blocks as outlined in Figure 2.2. The IRD developer is free to decide on the hardware architecture as long as it fulfils the NorDig requirements for the relevant profile.

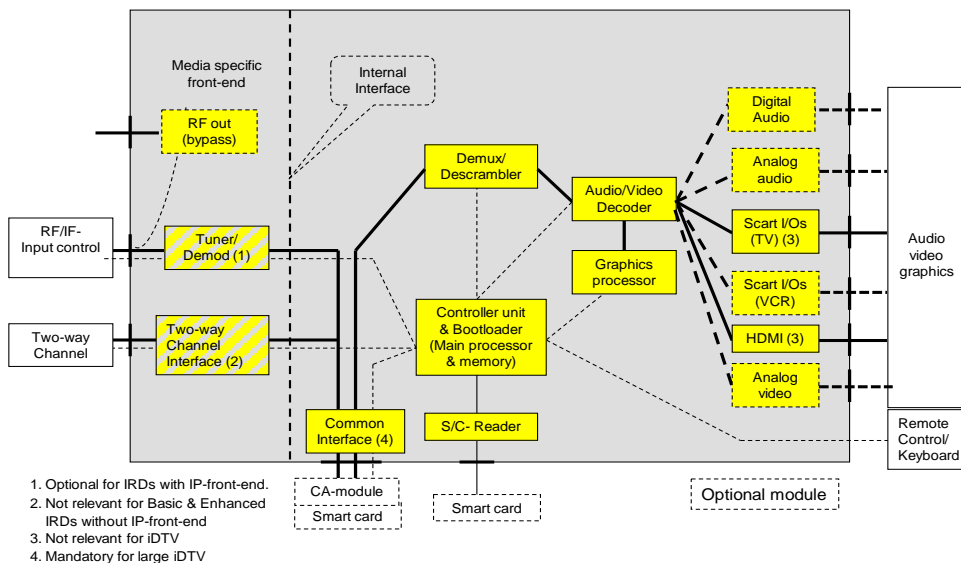

Figure 2.2 Functionality of Hardware and Firmware for NorDig IRD

2.2.2 RF Interface and Tuner/Demodulator

The RF interface connects to the incoming modulated signal. The tuner/demodulator block performs channel (frequency) selection, demodulation and error correction of the incoming signal. Output from the tuner/demodulator block is a transport stream that is fed to the demultiplexer block, or – if present – the external plug-in conditional access (CA) module. One embedded tuner/demodulator block is required, for cable, satellite or terrestrial input. The satellite tuner/demodulator block controls the frequency band selection of the external RF unit and supplies power to it.

The RF-interface is not relevant for IRDs intended for IP-based networks, where the front-end functions are performed by the Interaction Channel Interface, see below.

All channel selections in the T/D blocks are controlled by the central Controller unit. See also chapter 3.

2.2.3 R_{fin}-R_{fout} Bypass (option)

R_{fin}-R_{fout} is an internal bypass from input to output of IRD. See also section 8.2.

2.2.4 Two-way Interface

The two-way interface connects to the IP-based network. It allows the user to access (two-way) interactive services, see chapter 15 and IP-based services. See also section 8.3.

The two-way interface is not relevant for NorDig. However, the two-way interface will act as front-end interface for reception of multicast signals in case of IPTV, where IPTV is defined as a DVB-transport stream encapsulated in IP packages multicasted or unicasted over an IP-network, see sections 3.5 and 8.3.

The two-way interface to the IP-based network may also be used by the NorDig IRD to download new software. This is the most appropriate mechanism for software updates that are applicable to IP-based services, as they are immediately available to NorDig IRDs that are connected to the IP-based network.

2.2.5 Demultiplexer

The demultiplexer block synchronises with the transport stream coming from the tuner/demodulator, the interaction channel (in case of IP front-end) or the CA module, and selects the appropriate audio, video and/or private data elementary streams according to the service selections made by the user. The demultiplexer block also contains functions related to descrambling of services that are subject to conditional access data in the smart card. The private data streams are managed by the IRD controller unit (main processor), while the audio and video streams are output to the Video/Audio decoder block. See also chapter 4.

2.2.6 Video/Audio Decoding

The audio and video decoding units recover the audio and video signals from the input elementary packet streams. This involves processes like descrambling, de-packetisation, decompression, synchronisation with related services, digital to analog conversion, etc. The analog signals are output to external baseband connectors while the digital signals are output to the HDMI/ S/PDIF interfaces. See also chapters 5 and 6 and clause 7.3.1 of HbbTV specification ETSI TS 102 796 [30].

2.2.7 Graphics processor

The graphics processor unit generates graphics and text to be displayed for the user, see chapters 7 and 15

2.2.8 IRD Controller Unit and System Software Update (Bootloader)

The IRD controller unit is a microprocessor system that manages all the internal units and all attached external plug-in units. See also chapter 10.

The Bootloader is a system software download capability, implemented as a firmware module independent of the system software. It can be initiated via the Navigator. See also chapter 13.

2.2.9 Common Interface and Plug-in CA Module

The Common Interface is a transport stream input/output.

The Plug-in CA module is an external plug-in conditional access (CA) module to be attached via the Common Interface. The main task of the CA module is to perform descrambling of services subject to conditional access. The CA module may be connected to an external smart card. See also section 9.2.

2.2.10 Smart Card Interface(s) and Smart Card Reader(s)

The smart card readers allow external smart card(s) to be connected to the Controller unit. See also section 9.3.

2.2.11 Remote Control

The remote control allows the user to remotely interact with the IRD and its applications such as for example move cursors and graphical pointers and to make selections in menus displayed by the graphics processor. See also section 8.7.

The remote keyboard (option) allows the user to enter alphanumeric symbols in addition to the functions provided by the remote controls.

2.2.12 Video/Audio Interfaces

HDMI and SCART (optional from 2014) interfaces. See section 8.4 and 8.6.

Note 1: Not relevant for iDTV.

Note 2: Optional

2.2.13 Audio Output Interfaces (option)

One analogue stereo audio output interface, based on RCA or SCART connector, see also section 8.4.
One digital audio interface, based on S/PDIF, see also section 8.5.3.

2.2.14 Main hardware/firmware functions-Overview per configuration

Table 2.1 indicates some of the major hardware/firmware functions in the IRD. A more detailed overview, which also includes the NorDig profiles, is given in Annex J. Detailed requirements are specified in chapters 3-16.

NorDig IRD	STB	iDTV
Video decoding/processing		
MPEG-2 MP@ML SDTV video	M	M
MPEG-4 AVC HL@L4 SDTV + HDTV video	M	M
Audio decoding/processing		
MPEG-1 Layer II audio decoding	M	M
HE-AAC Level 4, including down-mix to stereo	Alt (5)	Alt (5)
HE-AAC-to-AC-3 or DTS for digital output (1)	Alt (5)	Alt (5)
AC-3 (AC-3 pass-through) digital output (1)	Alt (5)	Alt (5)
E-AC-3 , including down-mix to stereo	Alt (5)	Alt (5)
E-AC-3 (E-AC-3 to AC-3) digital output (1) (4)	Alt (5)	Alt (5)
Subtitling		
DVB (SDTV) subtitling	M	M
DVB HDTV Subtitling	M	M
EBU Teletext subtitling (subtitling pages)	M	M
Teletext and API		
EBU Teletext (normal pages)	M	M
HbbTV	O (6)	O (6)
CA		
Embedded CA	(2)	(2)
Interfaces		
DVB-C front-end for CATV IRDs	M	M
DVB-S front-end for DTH IRDs	M	M
DVB-S2 front-end for DTH IRDs	M	M
DVB-T front-end for DTT IRDs	M	M
DVB-T2 front-end for DTT IRDs	O(7)	O(7)
Two-way interface for IPTV IRDs	M	M
Analogue SD video output (SCART, component, composite, S-video)	R	O
HDMI with HDCP (3)	M	M/R(3)
Digital Audio Output (e.g. SPDIF) (1)	R/O	R/O
Common Interface Plus for CA	(2)	M(2)
Smartcard Interface for embedded CA (2)	(2)	(2)

M; Mandatory, R; (Highly) Recommended, O; Optional item to include, Alt; minimum one among several options

- 1) If IRD is equipped with a digital audio output (like S/PDIF), see section 8.5.
- 2) As specified by relevant network/CA-operator, see chapter 9. Common Interface Plus is mandatory for for iDTV-sets with screen diagonal larger than 30 cm and highly recommended for iDTV-sets with smaller screen diagonals, see section 9.2.
- 3) Interfacing an (DigitalEurope) HD Ready approved TV Display set and an external STB. HDMI input is mandatory for iDTV-sets with screen diameters larger than 30 cm and highly recommended for iDTV-sets with smaller screen diameters, see section 9.2.
- 4) E-AC-3 is not defined for S/PDIF output, instead an 'E-AC-3 to AC-3' conversion is expected for the S/PDIF output to ensure interoperability with legacy A/V receivers. For newer A/V receivers supporting E-AC-3, HDMI interface shall be used
- 5) At least one advanced audio decoder shall be included, see details in section 6.1.
- 6) Optional for NorDig IRDs with a basic profile, mandatory for NorDig Hybrid IRDs
- 7) May be mandatory in some terrestrial networks, ref operator's requirements

Table 2.1 Main hardware/firmware functions for the various IRD configurations

2.2.15 Additional hardware/firmware for the PVR features

The NorDig PVR will include embedded or attached hardware/firmware (not shown in Figure 2.1) for recording of live services (TV, radio etc) in persistent memory (like HDD) for later playback, (even if the IRD has been completely powered off between the recording and the playback), see section 14.3.

2.3 System Software and API

2.3.1 Introduction

The NorDig software may contain two main parts, system software and applications (not relevant for NorDig Basic). The system software shall provide two main sets of functions. One set is accessible within the system software only and includes functions for control of hardware/firmware and handling of service information. Another set is available internally and externally for applications, and constitutes the Application Programming Interface, API (not relevant for NorDig Basic). See also chapter 15.

2.3.2 Principal Software Architecture

An important feature in this software architecture is the possibility of replacing the whole software, with exception of the bootloader software itself. This allows the exchange or upgrade of the entire software 'over the air' or though the IP-based network according to the need for new functionality or for bug fixing (e.g. drivers).

The download of applications uses an internal function from the API, outside of the bootloader software.

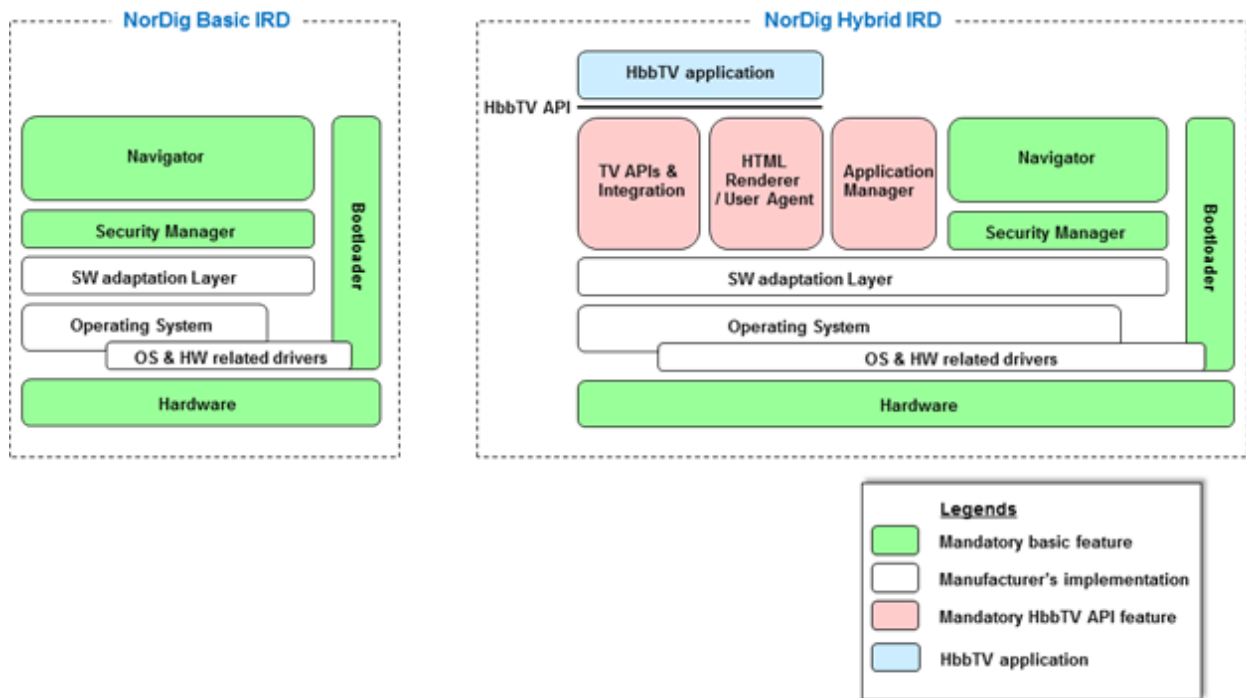

Figure 2.3: Possible software architecture of a NorDig, to the left a NorDig Basic IRD without NorDig API and to the right a NorDig Hybrid IRD with NorDig API (i.e. HbbTV API).

Figure 2.3 illustrates only examples of NorDig IRD software architecture. The IRD manufacturers are free to implement system the way they want as long as it fulfils the NorDig IRD specification.

2.3.3 System Software

The NorDig IRD includes a System Software in compliance with DVB specifications, i.e. APIs, PSI/SI (1), Navigator, teletext, subtitling and Common Interface. The system software can be completely upgraded via the bootloader (2).

Note 1: The NorDig IRD with an IP-based front-end will be based on a modified use of the DVB service information (SI), see section 12 and Annex C.

Note 2: The bootloader is by definition a part of the hardware/firmware.

2.3.4 NorDig APIs

The NorDig IRD includes an open API in compliance with the HbbTV APIs (not relevant for NorDig Basic).

2.3.5 PVR related software

The NorDig PVR includes additional software for handling of the PVR features, see chapters 12 and 14, and section 13.3.

2.4 General Product Requirement

2.4.1 General

The NorDig IRD shall satisfy all mandatory legal requirements, as specified for the European Union and by the relevant national authority.

2.4.2 Energy Efficiency

The NorDig IRD should be energy efficient and minimise its power consumption during all modes of the IRD (Normal TV mode ("ON"), Standby mode etc). Manufacturers of NorDig IRDs are recommended to follow voluntary agreement(s) on energy consumption for complex set-top-boxes under the EU regulation and/or the European Commission's regulation (EC) No 1275/2008 implementing Directive 2005/32/EC of the European Parliament and of the Council with regard to ecodesign requirements for standby and off mode electric power consumption of electrical and electronic household and office equipment for their IRD products.

2.4.3 Requirements that are optional for a time period (grace period)

NorDig normally introduce new mandatory requirements or changes to existing requirements with a certain time period from publication to when it becomes mandatory to support for new products, (typically via a note: "*Optional for NorDig IRDs that are launched before <date>*"). This time period is here referred to as a "grace period" for a requirement. The purpose with the grace period is to give IRD manufacturer a reasonable time to implement according to the new or modified requirements. A NorDig test lab refers here to a test lab that among things performs verification testing of an IRD's implementation according to NorDig Unified IRD specification and NorDig Test Plan.

Unless an Operator or relevant network specifies anything else, the date in NorDig specification from when new IRD models must support a requirement, refers to the date relevant NorDig test lab(s) receive a new IRD (excl time for testing and any queue time). This means if an IRD is received at the relevant testlab(s) before a grace period date, the applicable requirement(s) is still optional even if the time for testing passes this date at the testlab. Testlabs' time for verification testing IRDs can sometimes vary significantly depending on the queue for testing etc.



PART A: Hardware and Firmware

3 The Frontend of the NorDig IRD

3.1 Common Features

3.1.1 General Features

The NorDig IRD shall contain at least one Tuner/Demodulator for cable or one for satellite or one for terrestrial DVB/MPEG signals, or an interface for reception of corresponding signals from IP-based networks, see section 3.5.

A NorDig IRD with:

- a satellite front-end supporting DVB-S and DVB-S2 is from here referred to as a satellite NorDig IRD.
- a cable front-end supporting DVB-C is from here referred to as a cable NorDig IRD.
- a terrestrial front-end supporting DVB-T and DVB-T2 is from here referred to as a terrestrial NorDig IRD.
- an IP-based front-end supporting IPTV over managed networks is from here referred to as a terrestrial IPTV NorDig IRD.

A NorDig IRD refers to all kinds of IRDs (satellite, cable, terrestrial, IP-based).

3.1.2 Common Scanning Procedures

The NorDig IRD shall be able to automatically scan through the whole frequency range available for each of the available Tuners/Demodulators and tune in to the correct DVB framing structure, channel coding and modulation to deliver the incoming transport stream to the next units. The tuning data shall be stored in a service list, in order to allow a quick tune in to the selected transport stream, see section 13.2. For more detail, see below.

Note: Frequency scanning is not relevant for NorDig IRDs with IP-based front-end.

3.1.3 Quality Reception Detector

The NorDig IRD shall be equipped with a reception quality detector.

3.2 Satellite Tuner and Demodulator

This chapter describes the requirements for NorDig IRDs with satellite front-end (satellite NorDig IRD).

3.2.1 General

The satellite NorDig IRD shall include at least one tuner/demodulator unit for reception of signals from a satellite RF-outdoor unit (1).

Note 1: In this specification RF means the input to the IRD, unless otherwise specified.

3.2.2 RF/IF Characteristics

The available transponder bandwidths and transponder powers vary with the different satellites. Consequently, a range of symbol rates and forward error correction rates may be employed.

The incoming digital DVB signals will comply with DVB-S, see EN 300 421 [13] or DVB-S2, see ETSI EN 302 307 [22], including QPSK and 8PSK waveforms. All specified error correction rates may be used and filtering may be based on any of the standard roll-off rates that are specified in the `satellite_delivery_system_descriptor`, see Table 13.1.

The satellite NorDig IRDs shall support the following symbol rates on the incoming carriers:

- QPSK-carrier: From 7.5 MBaud to 45Mbaud (1) (2)
- 8PSK-carrier: From 5 MBaud to 30 MBaud (1)

Note 1: The Common Interface Plus is specified for maximum 96 Mbps while the DVB Common Interface is specified for maximum 72 Mbps, see section 9.2. The incoming carriers will not carry

signals with higher bit rates than 72 Mbps when IRDs with DVB-CAMs are targeted.

Note 2: From 7.5 MBaud to 30 MBaud for IRDs that are launched before July 2011

3.2.3 Input Frequency Range/Tuning Range

The input frequency band to the RF-unit with antenna may cover the frequency range 10.7 to 12.75 GHz on each of two polarisations. The RF unit may be configured to select and convert any of the four 1 GHz bands (upper or lower half band on each polarisation) to IF. Alternatively, it may be configured to provide a number of transport streams on a single cable, see section 3.2.5

The satellite NorDig IRD shall be able to tune to any DVB carrier located within the IF band 950-2150 MHz with characteristics and symbol rate as specified in section 3.2.2.

3.2.4 Demodulation and Error Correction

Demodulation, descrambling and error correction shall be performed for all symbol rates given above and for all error correction rates and filter roll-off rates as specified for DVB-S, see EN 300 421 [13] and for DVB-S2, see ETSI EN 302 307 [22] and the *satellite_delivery_system_descriptor*, see Table 13.1.

3.2.5 Control Signals

The Tuner/Demodulator shall be able to select between at least two RF units, upper and lower band as well as polarisation within each unit in accordance with EN 61319-1 [12], level 1 (the “DiSEqC” specification, level 1.0), see also section 3.2.7.3.

The Tuner/Demodulator shall be able to select transport stream in accordance with EN 50494 Satellite [10] (“Signal distribution over a single coaxial cable in single dwelling installations”). The selected user band(s)/frequency(ies) for transport from the outdoor unit to the IRD shall be stored as local default values.

3.2.6 Tuning/ Scanning Procedures

The satellite NorDig IRD shall establish, store and update a list of all services that are available in the network it is connected to, see section 13.2, and use these data for service selection when available.

The satellite NorDig IRD shall either use the NIT information or the scanning procedure for retrieving the services available on the network.

Information will also be given in PSI/SI, which will enable the IRD to track services which are moved, removed or added within available multiplexes, see ETSI EN 300 468 [27]. Such information shall be decoded and used for updating the service list.

The satellite NorDig IRD shall be able to tune to new carriers when it is connected to a new network, or when the stored service list is no longer available, or when manually initiated via the user interface. The tuning shall be based on stored default values or a scanning procedure when no default values are stored.

It shall be possible to set and store specific *network default values* for search of digital carriers (“Homing carriers”), as required for the targeted network(s). The values shall be set either manually via the user interface, or as part of the stored default values in the NorDig IRD.

The *network default* values shall for each stored network id include, see section 13.2.2:

- Network id
- Polarisation, frequency, modulation mode and symbol rate for carriers that carry service information about actual and other transport streams.

In case there are no stored data for the selected network, the IRD shall scan through the full frequency band on both polarisations based on:

- Polarisation and carrier frequencies as specified in section 3.2.3.

- Modulation mode: QPSK or 8PSK, where QPSK should be attempted first with its associated FEC values, see section 3.2.2.
- Symbol rate: As specified in section 3.2.2, with steps corresponding to 0.1 MBaud, starting with the range 22-30 MBaud.

3.2.7 Satellite Tuner Interface and Signal Levels

3.2.7.1 RF Input Connector

The satellite NorDig IRD shall include one input connector, type: ISO 169-24/IEC 61169-24 [40], F-type, female, 75 ohms.

The return loss shall be 10 dB (typically), in worst case 8dB min.

3.2.7.2 Signal Level

The satellite NorDig IRD shall accept input signals with a level in the range -25 to -60 dBm, and demodulate the signals with a performance as specified in section 3.2.8.

3.2.7.3 Power Supply and Control Signals (to RF unit)

The satellite NorDig IRD shall provide power supply and control signals to the external RF-unit as specified below:

Parameter		Value			Unit
		Min.	Typ.	Max.	
LNB Supply Voltage (Control Signal)	Vertical Polarisation	12.5		14.0	V
	Horizontal Polarisation	17.0		19.0	V
High Band Selection	Frequency	20	22	24	kHz
	Duty Cycle	40	50	60	%
	Peak-to-Peak Voltage	0.4	0.6	0.8	V
	Transition Time	5	10	15	µs
	Output Impedance at 22 kHz			50	Ω
LNB Current Power Supply		400(1)			mA
Control signals for DiSEqC:		See EN 61319-1 [13]			
Control signals for single cable:		See ETSI TR 101 211 [28]			
Note 1: The IRD should be able to provide up to 1000mA for the initial 25 mseconds					

Table 3.1 Power supply and control signals for the RF-unit

3.2.8 Performance

The satellite NorDig IRD shall be able to store tuning data for all MPEG/DVB carriers in the satellite network.

Comment: The digital carriers carry an MPEG transport stream that may include M2-level and/or M4-level bitstreams.

The satellite NorDig IRD IF back/back error performance for a single carrier shall comply with the requirements given in EN 300 421 (section 5) [13] for DVB-S carriers and in ETSI EN 302 307 [22] for DVB-S2 carriers. The NorDig IRD shall provide QEF reception for the maximum C/N (Es/No) ratios that are specified in Table 3.2.

Modulation	Code Rate	C/N (Es/No) performance (dB)	
		DVB-S	DVB-S2
QPSK	1/4	n/a	-1.4
QPSK	1/3	n/a	-0.2
QPSK	2/5	n/a	0.7
QPSK	1/2	3.8	2.0
QPSK	3/5	n/a	3.2
QPSK	2/3	5.6	4.1
QPSK	3/4	6.7	5.0
QPSK	4/5	n/a	5.7
QPSK	5/6	7.7	6.2
QPSK	7/8	8.4	n/a
QPSK	8/9	n/a	7.2
QPSK	9/10	n/a	7.4
8PSK	3/5	n/a	6.5
8PSK	2/3	n/a	7.6
8PSK	3/4	n/a	8.9
8PSK	5/6	n/a	10.4
8PSK	8/9	n/a	11.7
8PSK	9/10	n/a	12.0

Table 3.2 Maximum C/N (Es/No) for QEF reception (1)

Note 1: C/N measured for a bandwidth that equals the symbol rate.
 Quasi-Error-Free (QEF) means less than one uncorrected error event per hour, corresponding to (MPEG TS Packet Error Rate) PER= 10^{-7} or BER = 10^{-10} to 10^{-11} at the input of the MPEG-2 demultiplexer

The satellite NorDig IRD error performance in a multi-carrier environment shall be tested in IF back/back. ("Back-to back" implies that the test signal shall be applied at the input of the RF/IF (tuner), see Figure 2.2, i. e. only degradation in the NorDig IRD itself is measured).

The satellite NorDig IRD shall be able to select any channel within an array of digital channels with equal carrier level, bandwidth and channel spacing. Given that the symbol rate is R the channel spacing shall be 1.25·R for DVB-S carriers and 1.20 R for DVB-S2 carriers.

The satellite NorDig IRD shall select, demodulate and correct errors such that the performance specified in Table 3.2 is met for a wanted carrier at any frequency and any power level within the ranges specified above and with characteristics and symbol rates as specified in section 3.2.2. No adjacent carrier is required for this case.

With adjacent carriers of equal power levels, equal symbol rates and with carrier separations as specified above, the satellite NorDig IRD shall select a wanted carrier between adjacent carriers, demodulate and correct errors such that the performance specified in Table 3.2 is met with a C/N allowance of 0.5 dB for the adjacent carriers.

3.3 Cable Tuner and Demodulator

This chapter describes the requirements for NorDig IRDs with cable front-end (cable NorDig IRD).

3.3.1 General

The cable NorDig IRD shall provide the possibility to access digital DVB carriers via the internal front-end for cable networks.

The digital DVB signals are QAM modulated as specified in EN 300 429 [14].

The incoming carriers may in addition to the digital carriers include analogue PAL television signals using AM-VSB modulation, as specified in ITU/R Report 624-4 [61], standards PAL-B, PAL-G.

The cable NorDig IRD shall be able to operate flawless in a CATV network specified in accordance to EN 60728 and EN 50083 [7].

The front-end shall convert signals received via a cable system (CATV) from RF level to baseband level. It shall include QAM demodulation for provision of digital transport streams.

Many CATV systems use a 7 MHz frequency raster in the VHF frequency range and an 8 MHz raster in the Hyperband and UHF-band for analogue PAL TV services. For digital DVB signals an 8 MHz frequency raster is/will be used over the whole CATV frequency range. However, the frequency rasters may be different in the different cable networks.

The analogue signals shall be identified by the vision carrier and on a frequency channel allocation basis.

Note: DVB-C2 is specified by DVB and as an ETSI standard. DVB-C2 will be considered for NorDig.

3.3.2 RF Characteristics

3.3.2.1 Network characteristics

The cable NorDig IRD shall operate with input network and channel RF characteristics as specified in Table 3.3.

Parameter	Type of signal	Value
Input Frequency range:	Digital signals	Full band: 110 - 862 MHz, with centre frequencies in the band 114-858 MHz and with an accuracy of +/- 30 kHz (1)
	Analogue signals	47 - 862 MHz and with an accuracy of centre frequency of +/- 30 kHz
Channel bandwidth:	Digital signals	8 MHz (2)
	Analogue signals	7 and 8 MHz
Input level:	Digital signals	47 - 77dB μ V at 75 Ohms for 256 QAM 43 - 73 dB μ V at 75 Ohms for 64 QAM
	Analogue signals	TV/AM-VSB: 57 - 80 dB μ V at 75 Ohms FM radio: up to 70 dB μ V at 75 Ohms
Total Input Power (80-862 MHz):	Digital & analogue	<93 dB μ V at 75 Ohms
Carrier-to-Interference ratio for total power (discrete and broadband ingress signals)	Digital & analogue	>52 dB within the channel bandwidth
Composite Second Order (CSO) distortion for analogue modulated carriers	Analogue signals	equal or better than 57 dB
Composite Triple Beat (CTB) distortion for analogue modulated carriers	Analogue signals	equal or better than 57 dB.
Input Impedance:		75 Ohms

Modulation:	Digital signals	16-QAM, 64-QAM, 128-QAM and 256-QAM
Symbolrate:	Digital signals	4.0 Msymbols/s to 7.0 Msymbols/s (2) The rates are set in steps of 1 ksymbols/s
Note 1: An extension of the full band, up to 1 GHz, is being considered for future IRDs		
Note 2: Most cable networks use symbol rates close to 7.0 Msymbols/s or 6.952 Msymbols, as specified for EuroDcscis, see ITU-J. 222.1 [60]. Prior to the modulation, the I and Q signals are required to be square-root raised cosine filtered with a roll-off factor of 0.15. The cable IRD shall perform the inverse signal processing, in order to recover the baseband signal.		

Table 3.3 RF front-end characteristics for NorDig IRDs with a cable front-end

3.3.2.2 Input and bypass connectors

The cable NorDig IRD shall have at least one input connector, type:

- IEC female in accordance with IEC 61169-2 [39], alternatively
- F female in accordance with ISO/IEC-61169-24 [40]

The input impedance shall be 75 Ω.

In the case that a bypass connection is provided, see section 3.3.3, the output connector shall be:

- IEC male in accordance with IEC 61169-2, part 2, alternatively [39]
- F female connector in accordance with ISO/IEC-61169-24 [40]

The output impedance shall be 75 Ω.

3.3.3 Bypass RF_{in} to RF_{out}

The RF signals should (1) be bypassed from RF_{in} to RF_{out} independently from the status of the cable NorDig IRD (operational or stand by), so that connected equipment can operate even if the NorDig IRD is in stand by.

Note 1: RF By-pass may be mandatory in some cable networks
--

The frequency range for the RF bypass shall be from 47 MHz to 862 MHz.

The cable NorDig IRD, when equipped with RF bypass, should include user setting to disable or enable the RF bypass gain in stand-by mode. When the RF bypass gain is disabled, the maximum RF bypass gain should -4dB and when the RF bypass gain is enabled, the RF bypass gain should be from -1 dB to +3 dB.

The degradation of the signals caused by the RF bypass compared to the input signal shall be less than:

- 1 dB in case of signal-to-noise ratio
- 2 dB in case of composite triple beat ratio (CTB)
- 2 dB in case of composite second order ratio (CSO)

The figures relate to the composite intermodulation ratios for CSO and CTB as specified in Table 3.3, as well as the signal-to-noise ratio defined in EN 60728 [8]. The maximum degradation factor shall not be exceeded under the worst case conditions specified in Table 3.3 and in section 3.3.5.2.

3.3.4 Tuning/Scanning Procedure

The cable NorDig IRD shall either use the NIT information or the scanning procedure for retrieving the services available on the cable network.

The cable NorDig IRD shall be able to receive digital signals in the full frequency band, 114-858 MHz and be able to decode all digital carriers in this range, in all modes specified for modulation and in any symbol rate specified in Table 3.3.

The cable NorDig IRD shall establish, store and update a list of all services that are available in the network it is connected to, see section 13.2, and use these data for service selection when available.

The cable NorDig IRD shall perform a tuning procedure as specified below when it is connected to a new network, or when the stored service list is no longer available, or when manually initiated via the user interface.

1) Step 1 (use of NIT):

The cable NorDig IRD shall search for and tune to a digital DVB carrier. The received Service Information, as found valid (see notes 1 and 2) shall be used to establish the service list (see section 13.2). The search shall be based on the default values specified below. In case no valid NIT is detected, go to

2) Step 2 (false NIT (2)):

The cable NorDig IRD shall indicate that no carrier is detected and that a manual setting of input parameters is required; see below.

Note 1: The received data include descriptors for the actual transport stream and may include data for other transport streams; in order to update the service list, see section 13.2.2.

Note 2: In smaller cable networks with a simple QPSK-QAM converter without the possibility for SI information correction (e.g. the NIT of the satellite distribution system has not been replaced by the correct CATV-NIT).

It shall be possible, via the cable NorDig IRD's user interface, to manually set and store the network_id (NID), as relevant for the network that the IRD is connected to.

It shall be possible to set and store specific **network default values** for search of digital carriers, as required for the targeted network(s). The values shall be set either manually via the user interface, or as part of the stored default values in the NorDig IRD.

The **network default** values shall for each stored network id include:

- Network id
- Frequency (ies) and modulation mode(s) for carriers that carry service information about actual and other transport streams, see section 13.2.2
- Symbol rate(s) for the specified carrier(s).

In case there are no stored data for the selected network, the stored **factory default** values shall be used for the initial search (Step 1 above). In case these default values do not result in reception of a carrier, a full search, covering all frequencies, modulation modes and symbol rates shall be performed (Step 2).

The cable NorDig IRD shall as a minimum store a **factory default** value set, with the following data:

- Carrier frequencies: $114\text{MHz} + n \times 8\text{MHz}$, where n is an integer in the range 0 to 93, see Table 3.3.
- Modulation mode: 16 QAM, 64QAM, 128QAM and 256QAM, where 128QAM and 16 QAM should be attempted last.
- Symbol rate: 6.952 MSymbols/s (first attempt). If this rate does not result in reception, the following rates should be attempted: 6.950, 6.900, 6.875, 6.125 (1) and 6.000 (1) Msymbols/s.

3.3.5 Performance Data

3.3.5.1 Return loss and Noise figure

The performance data below shall be satisfied:

- Return loss: 10 dB (typically), in worst case 8 dB min.
- Noise figure: less than 8 dB

3.3.5.2 Requirements under Cable specific conditions

The cable NorDig IRD shall support operations at any levels that may correspond to those in a CATV network conforming to EN60728 and EN 50083 [7], where the loading is flat and where the digital signals have a level of 0 dB (ref) and the analogue signals a level that is 6 dB higher (i.e. the digital signals have a 6 dB back-off (1) from the analogue signals). The values of the individual signals shall be within the limits specified in Table 3.3, with a total load up to 93dB μ V at any IRD input.

Note 1: The back-off is the ratio between the RMS value of the PAL vision carrier level during sync puls interval and the average QAM level.

The back-off between digital and analogue signals may in practice differ between the various networks, e.g some networks operate with 6 dB back-off for 256QAM and 10dB for 64QAM, while other may operate both 256QAM and 64 QAM signals with 4 dB back-off.

The cable NorDig IRD shall be able to handle DVB-C signals at any levels as specified in this section 3.3, including operation:

- At any carrier frequency, with restrictions as specified of adjacent channels being present, and
- At minimum and at maximum input level (see Table 3.3) of the IRD, and
- With an echo with any of the values specified in Table 3.3

For any combination of these operational conditions, the NorDig IRD shall provide the minimum performance that is specified below:

- Noise limited performance as specified in sections 3.3.5.3, and
- Operation with noise and echos, as specified in section 3.3.5.4, and
- Operation with images from other signals, as specified in section 3.3.5.5, and
- Operation with adjacent digital signals, or adjacent PAL/G signals, with NICAM stereo carrier, with levels as specified in sections 3.3.5.6 and 3.3.5.7.

3.3.5.3 C/N (Es/No) performance for Reference BER

The performance requirements used in this section 3.3.5 are referring to the QEF condition, where Quasi Error Free (QEF) means less than one uncorrected error event per hour. This requirement corresponds to $BER = 2 \times 10^{-4}$ before the Reed Solomon decoding is used and approx 10^{-11} at the input of the MPEG-2 multiplexer.

The cable NorDig IRD shall have a BER performance better than 2×10^{-4} for the C/N ratios specified below, for all specified input levels:

QAM:	C/N (Es/No):	Comments
256	32.0 dB	when the input receive signal is in the range 54 to 77 dB μ V
	35.0 dB	when the input receive signal is in the range 47 to 54 dB μ V
128	29.0 dB	
64	26.0 dB	
16	20.0 dB	

Table 3.4 Minimum performance for cable tuner when $BER=2 \times 10^{-4}$ before Reed-Solomon error correction. C/N is referred to a noise bandwidth that equals the symbol rate.

The residual BER for C/N >36 dB (256-QAM), >33 dB (128-QAM), >30 dB (64-QAM) and >24 dB (16-QAM) shall be less than 10^{-7} .

3.3.5.4 C/N (Es/No) performance with echo applied

The cable NorDig IRD shall perform as specified in Table 3.3, plus an allowance of 1 dB when an echo is applied in accordance to the template in Figure 3.1.

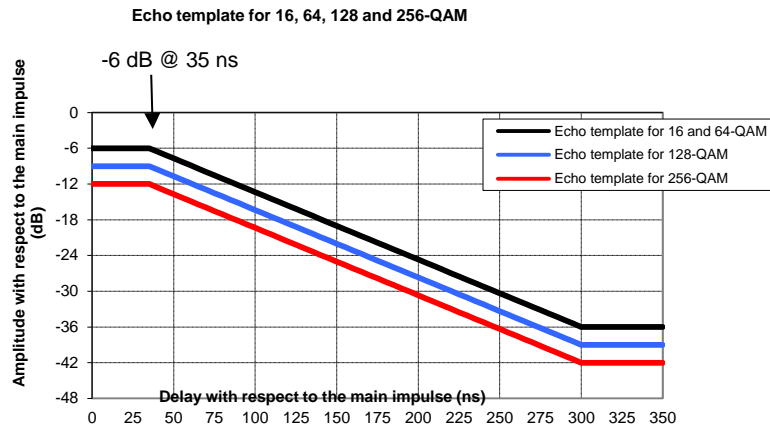

Figure 3.1 Echo template for echoes for 16, 64, 128 and 256-QAM

3.3.5.5 Image rejection performance

The cable NorDig IRD shall perform as specified in section 3.3.5.3 with an analogue or digital signal at +10dBc in any portion of the RF band other than the adjacent channels.

3.3.5.6 Adjacent channel performance for 16, 64 and 128 QAM

The cable NorDig IRD shall perform as specified in section 3.3.5.3 with

- a) Digital signals at 0dBc in the adjacent channels.
- b) Analogue signals at +10dB in the adjacent channels

The cable NorDig IRD shall perform as specified in section 3.3.5.3, plus an allowance of 0.2 dB with digital signals at +10dBc in adjacent channels.

3.3.5.7 Adjacent channel performance for 256 QAM

The cable NorDig IRD shall perform as specified in section 3.3.5.3 with digital or analogue signals at 0dBc in the adjacent channels.

The cable NorDig IRD shall perform as specified in section 3.3.5.3, plus an allowance of 0.5 dB with analogue signals at +10dBc in adjacent channels.

The cable NorDig IRD shall perform as specified in section 3.3.5.3, plus an allowance of 1.0 dB with digital signals at +10dBc in adjacent channels.

3.3.6 Spurious Emission

3.3.6.1 LO leakage

The LO leakage conducted emission (including LO and spurious) from the cable NorDig IRD, measured at the antenna input connector shall be $\leq 46\text{dB}\mu\text{V}$ over the range 65 to 862MHz, see EN 55013 [11]

3.3.6.2 Spurious emission

The spurious emission from the NorDig IRD to the network, as measured at the antenna input connector, shall be less than $34\text{dB}\mu\text{V}$ over the range 5MHz to 65MHz and less than $30\text{dB}\mu\text{V}$ over 65 to 862 MHz.

Generally, spurious emission should not affect the sensitivity of the receiver.

3.3.6.3 Radiation

The radiation from the cable NorDig IRD shall comply with EN 55013 [11]

3.4 Terrestrial Tuner and Demodulator

This chapter describes the requirements for NorDig IRDs with terrestrial front-end (terrestrial NorDig IRD).

3.4.1 General

The terrestrial NorDig IRD (i.e. IRD with a terrestrial front-end) shall include at least one tuner/demodulator for reception of signals from terrestrial transmitters, broadcasting in accordance with EN 300 744 [20] (DVB-T), or in accordance with EN 302 755 [21] (DVB-T2).

The terrestrial NorDig IRD-T2s, capable of receiving broadcasts according to EN 302 755 [21] shall also be capable of receiving broadcasts according to EN 300 744 [20]. Such receiver is in the following referred to as "NorDig IRD-T2", when there is a need to differentiate such a receiver from a receiver supporting DVB-T only.

The digital transmissions may share frequency bands with other transmissions; successful reception will depend on e.g. network configuration, channel characteristics, time-varying interference from other "analogue" or "digital" transmitters and the receiver performance. The transmission networks of DVB-T/T2 may include single frequency networks (SFN).

Comment: The possibility to receive DVB-T/T2 signals in MATV networks is optional for NorDig IRDs with a terrestrial front-end. Such networks use a 7 MHz channel frequency raster in the VHF and an 8 MHz raster in the UHF frequency range for analogue TV services. For re-distribution of DVB-T/T2 signals it should be possible to maintain these rasters and to use only an 8 MHz raster.

3.4.2 Frequencies and Signal Bandwidths

3.4.2.1 General

The terrestrial NorDig IRD shall be able to receive channels in the VHF band III (1) and UHF bands IV, V and should be able to receive channels in VHF S band I, VHF S band II, UHF S Band III (see Table 3.5).

	Band	Frequency range	Requirement
VHF	VHF I	47 – 68 MHz	N/A
	S Band I	104 – 174 MHz	Optional
	VHF III	174 – 230 MHz	Mandatory
	S Band II	230 – 300 MHz	Optional
UHF	S Band III	300 – 470 MHz	Optional
	UHF IV	470 – 606 MHz	Mandatory
	UHF V	606 – 862 MHz	Mandatory

Table 3.5 Mandatory and optional frequency bands

3.4.2.2 Center Frequencies

The front-end shall for the supported frequency ranges be capable of tuning to the centre frequency f_c of the incoming DVB-T/T2 RF signal, see below and Annex B2:

8 MHz raster:

$$f_c = 114 \text{ MHz} + K * 8 \text{ MHz, where}$$

K is an integer number, running from 0 to 93.

7 MHz raster:

$$f_c = 107.5 \text{ MHz} + L * 7 \text{ MHz, where}$$

L is an integer number, running from 0 to 27.

1.7 MHz raster (DVB-T2):

f_c shall be as specified in Annex B2.

Note 1: 8 MHz raster is mandatory for the UHF-bands. 7 MHz raster is mandatory for VHF band III. 8 MHz raster for VHF is optional. The support for 1.7 MHz raster in VHF Band III is optional, see below 3.4.2.4.

3.4.2.3 Maximum Frequency Offset

The terrestrial NorDig IRD shall be able to receive signals with an offset of up to 50 kHz (1) from the nominal frequency.

3.4.2.4 Signal bandwidths

For a DVB-T signal, an 8 MHz DVB-T signal corresponds to a signal bandwidth of 7.61 MHz and a 7 MHz DVB-T signal corresponds to a signal bandwidth of 6.66 MHz.

For 8 MHz DVB-T2 signal, a normal carrier mode corresponds to a signal bandwidth of 7.61 MHz and an extended carrier mode corresponds to a signal bandwidth of 7.71 MHz for FFT size of 8K and 7.77 MHz for FFT size of 16K and 32K.

For 7MHz DVB-T2 signal, a normal carrier mode corresponds to a signal bandwidth of 6.66 MHz and an extended carrier mode corresponds to a signal bandwidth of 6.80 MHz.

For 1.7 MHz DVB-T2 signal, a normal carrier mode corresponds to a signal bandwidth 1.54 MHz and an extended carrier mode corresponds to a signal bandwidth of 1.57 MHz.

The terrestrial NorDig IRD shall support for DVB-T2 signals both the normal and extended carrier modes, see EN 302 755 [21]. The terrestrial NorDig IRD shall for DVB-T2 signals follow network parameter change from normal to extended carrier mode and vice versa automatically without any need for user action.

VHF Bands:

The terrestrial NorDig IRD-T/T2 shall (1) for the supported frequency ranges be able to receive 7 MHz and should be able to receive 8 MHz DVB-T and DVB-T2 signals as well as 1.7 MHz DVB-T2 signals. If 8 MHz bandwidth is supported it shall automatically detect which DVB-T/T2 signal bandwidth is being used, and it shall be possible to receive the 8 MHz DVB-T/T2 signals on the 7 MHz channel frequency raster. If 1.7 MHz bandwidth is supported, the NorDig IRD-T2 shall automatically detect which DVB-T/T2 signal bandwidth is being used.

UHF Bands:

The terrestrial NorDig IRD-T/T2 shall for the supported frequency ranges be able to receive 8 MHz DVB-T and DVB-T2 signals.

Note 1: Reception from the VHF band III is mandatory. Reception from other VHF bands is optional.

3.4.3 Modes

The NorDig IRD terrestrial front-end shall be capable of correctly demodulating all non-hierarchical modes specified in EN 300 744 [20] (DVB-T). The front-end shall therefore be able to work with any combination of constellation (QPSK, 16-QAM or 64-QAM), code rate (1/2, 2/3, 3/4, 5/6 or 7/8), guard interval ($T_U/4$, $T_U/8$, $T_U/16$ or $T_U/32$) and transmission mode (2K or 8K).

The NorDig IRD should be able to receive the hierarchical modes in the DVB-T specification, see Annex B - 3.

The NorDig IRD-T2 terrestrial front-end shall be capable of correctly demodulating all allowed configurations, or “DVB-T2 modes”, as specified in EN 302 755 [21] (DVB-T2), with the following exceptions:

- Support for 1.7 MHz bandwidth is optional
- Support for Time Frequency Slicing (TFS) is optional. When TFS is supported the NorDig IRD-T2 shall be capable of correctly demodulating all allowed TFS configurations, or “TFS DVB-T2 modes”, as specified in EN 302 755 [21], including Annex E.
- Support for 10 MHz bandwidth is not required
- Support for PLPs carrying GS/GSE is not required
- Support for Transmission modes 16K and 32K, when 1.7 MHz RF bandwidth is supported, is not required

The terrestrial NorDig IRD-T2 shall not malfunction due to the existence of transmissions using configurations that the NorDig IRD-T2 is not required to support,

When TFS is supported the following shall apply: For 8MHz DVB-T2 signals with modulation parameters {32K, 256-QAM, CR=3/5, GI=1/16} on all data PLPs the NorDig IRD-T2 shall support reception of variable-bit rate PLPs in TFS with a TS peak data rate of up to 15 Mbps using up to six RF frequencies. Each TS is split into one data PLP and a common PLP.

Note 1: Although the bit rate of a TS is fixed the payload (of non-null packets) may be variable, which will require a variable-bit-rate PLP, since null packets in the TS are removed by DVB-T2 before transmission and re-introduced by the receiver.

Within the NorDig IRD specification the concept of “DVB-T2 mode” includes e.g. (the list is not exhaustive):

- Constellation (QPSK, 16-QAM, 64-QAM, 256-QAM), both rotated and non-rotated
- Code rate (1/2, 3/5, 2/3, 3/4, 4/5, 5/6)
- Guard interval (TU/128, TU/32, TU/16, TU*19/256, TU/8, TU*19/128, TU/4)
- Transmission mode (1K, 2K, 4K, 8K normal and extended, 16K normal and extended, 32K normal and extended)
- Pilot pattern (PP1, PP2, PP3, PP4, PP5, PP6, PP7, PP8)
- SISO/MISO
- PAPR (No PAPR reduction is used, ACE-PAPR only is used, TR-PAPR only is used, both ACE and TR are used)
- FEC Frame length (64800, 16200)
- Input Mode A (single PLP) or Input Mode B (Multiple PLPs – Common PLP, Type 1 and 2 up to the maximum allowed figure 255)
- Single RF frequency or Time Frequency Slicing (TFS)
- Normal Mode or High Efficiency Mode
- FEF parts (2) (3)
- Auxiliary streams (2)

Note 1: For allowed combinations of the DVB-T2 parameters see EN 302 755 [21].

Note 2: The NorDig terrestrial IRD is not required to demodulate or decode the content of FEF parts and auxiliary streams, but the existence of FEFs and/or auxiliary streams shall not cause receiver to malfunction.

Note 3: DVB-T2 transmissions may simultaneously carry both DVB-T2 Base signal and DVB-T2 Lite signal. DVB-T2 Lite signal contained in FEF part of the DVB-T2 Base signal is according to requirements in EN 302 755 version 1.3.1 or later.

The terrestrial NorDig IRD shall automatically detect which mode is being used.

3.4.4 Reception quality/Tuning/Scanning Procedures

3.4.4.1 General

The terrestrial NorDig IRD shall provide a scanning procedure over the whole (supported) frequency range.

The terrestrial NorDig IRD shall be able to provide reception quality information for a selected received frequency according to section 3.4.4.2 (Status check: Basic).

The terrestrial NorDig IRD should be able to provide reception quality information for a selected received frequency according to section 3.4.4.3 (Status check: Advanced).

3.4.4.2 Status check: Basic

The terrestrial NorDig IRD shall provide at least a basic status check function (accessible through the Navigator) that presents reception quality information for a selected frequency (currently viewed by the user).

The basic status check shall include:

- channel id, according to Annex B.2
- centre frequency
- Signal Strength Indicator, SSI (%), according to section 3.4.4.6
- Signal Quality Indicator, SQI (%), according to section 3.4.4.7

The basic status check values shall be updated regularly.

An end-user antenna installation should be made easier by providing an overall view of reception quality according to section 3.4.4.2 (Status check: Basic) for all installed multiplexes (frequencies) or enable the end-user to change the installed multiplexes (frequencies) easily. Reception quality information should be updated cyclically until this mode is exited.

3.4.4.3 Status check: Advanced

The terrestrial NorDig IRD should provide an advanced status check function (accessible through the Navigator) that presents the following information:

- channel id, according to Annex B.2
- centre frequency
- signal strength (dBm or dB μ V)
- signal strength indicator, SSI (%), according to section 3.4.4.6
- signal quality indicator, SQI (%), according to section 3.4.4.7
- C/N (dB)
- BER before Reed Solomon decoding (DVB-T) or BCH decoding (DVB-T2)
- Uncorrected packets

The integration time for the BER and uncorrected packets calculations shall be a period of 1 second.

In addition, it is recommended that the following information can be presented for the received frequency, transport stream and service:

- DVB-T/T2 mode
- transport stream id
- original network id
- network id
- service id
- T2 system id (NorDig IRD-T2)
- PLP id (NorDig IRD-T2)

The advanced status check values shall be updated regularly (e.g. every second).

3.4.4.4 Installation mode: Automatic Search, best service

The terrestrial NorDig IRD shall provide an automatic search that finds all of the multiplexes and services in the whole (supported) frequency range, see section 3.4.2. Before the automatic search is started, all service lists shall be deleted (if present).

The terrestrial NorDig IRD shall only display a service once in the service list (i.e. avoiding duplicate of the same services), even if the same service¹ (same triplet original_network_id, transport_stream_id and service_id) is received from multiple transmitters. If the same service can be received from several transmitters, the one with best reception quality shall be selected. The criteria for selection of the best received service (i.e. best reception quality) shall be based on the combination of the signal strength and signal quality according to sections 3.4.4.6 and 3.4.4.7. An example of a possible selection algorithm is described in Annex D.

It is recommended that the complete search function takes less than 5 minutes (at a reception location providing maximum 10 receivable DVB-T/T2 RF channels).

Note: In order to speed up the automatic channel search with a reception quality measurement, an approach with an automatic gain controller (AGC) based DVB-T/T2 signal detection can be implemented. The IRD implementation may sweep all the supported frequencies by detecting if there exists an RF signal by analyzing the AGC. After the sweep the IRD analyses only the frequencies where the AGC reported an RF signal present and verifies if the signal is a DVB-T/T2 signal. In case of DVB-T/T2 signal reception quality is measured.

3.4.4.5 Installation mode: Manual Search

In addition to the automatic search, it shall be possible to perform a manual search where the channel id (or frequency) is entered by the end user. The terrestrial NorDig IRD shall tune to this channel, search all available DVB-T modes, add all new services and replace existing equal services² (same triplet original_network_id, transport_stream_id and service_id) in the service list (without considering any quality criteria).

It is recommended that the graphical interface for the manual search shall make it easy for the end-user to perform consecutive manual searches.

The IRD should not override installed service parameters for a service stored in the manual search by a “quasi-static” (automatic) update. E.g. if an end-user has performed manual search for a frequency, the

¹ A service is uniquely identified by its DVB triplet (original_network_id, transport_stream_id and service_id) in all NorDig compliant terrestrial networks, except for the Norwegian terrestrial network, where only original_network_id and service_id are used to identify a service.

stored frequency in the manual search should not be overwritten by a “quasi-static” (automatic) update procedure.

3.4.4.6 Requirements for the signal strength indicator (SSI)

The terrestrial NorDig IRD shall be provided with a signal strength indicator (SSI). The value for the SSI shall be referred to the IRD RF signal input.

The terrestrial NorDig IRD shall be able to determine signal strength within a range starting from 15 dB lower than the reference signal level defined in Table 3.6 and up to 35dB above that value or maximum signal input level defined in section 0.

The absolute accuracy shall be ± 5 dB at RF signal input levels -80 dBm to -60 dBm and ± 7 dB for RF signal input levels higher than -60 dBm.

The relative accuracy should be ± 3 dB between centre frequencies within one frequency band, e.g. VHF Band III or UHF Band IV/V, supported by the receiver.

Signal strength indicator shall have a relative value within a range from 0% to 100% and with a resolution of 1%.

The signal strength indicator shall be updated regularly once per second.

The formulas to calculate the signal strength indicator (SSI) value in [%] are defined below.

See also Annex E: Implementation Guidelines for best service selection in automatic channel search

SSI = 0	if $P_{rel} < -15$ dB
SSI = $(2/3) * (P_{rel} + 15)$	if $-15 \text{ dB} \leq P_{rel} < 0$ dB
SSI = $4 * P_{rel} + 10$	if $0 \text{ dB} \leq P_{rel} < 20$ dB
SSI = $(2/3) * (P_{rel} - 20) + 90$	if $20 \text{ dB} \leq P_{rel} < 35$ dB
SSI = 100	if $P_{rel} \geq 35$ dB

where

$$P_{rel} = P_{rec} - P_{ref}$$

P_{rec} is referred to signal level expressed in [dBm] at receiver RF signal input.

P_{ref} is reference signal level value expressed in [dBm] specified in Table 3.6 for DVB-T and in Table 3.7 for DVB-T2.

Modulation	Code Rate	Reference signal level [dBm]
QPSK	1/2	-93
QPSK	2/3	-91
QPSK	3/4	-90
QPSK	5/6	-89
QPSK	7/8	-88
16-QAM	1/2	-87
16-QAM	2/3	-85
16-QAM	3/4	-84
16-QAM	5/6	-83
16-QAM	7/8	-82
64-QAM	1/2	-82
64-QAM	2/3	-80
64-QAM	3/4	-78
64-QAM	5/6	-77
64-QAM	7/8	-76

Table 3.6 Specified P_{ref} values expressed in dBm for all signal bandwidths, guard intervals and FFT for DVB-T signals.

Modulation	Code Rate	Reference signal level [dBm]
QPSK	1/2	-96
QPSK	3/5	-95
QPSK	2/3	-94
QPSK	3/4	-93
QPSK	4/5	-92
QPSK	5/6	-92
16-QAM	1/2	-91
16-QAM	3/5	-89
16-QAM	2/3	-88
16-QAM	3/4	-87
16-QAM	4/5	-86
16-QAM	5/6	-86
64-QAM	1/2	-86
64-QAM	3/5	-85
64-QAM	2/3	-83
64-QAM	3/4	-82
64-QAM	4/5	-81
64-QAM	5/6	-80
256-QAM	1/2	-82
256-QAM	3/5	-80
256-QAM	2/3	-78
256-QAM	3/4	-76
256-QAM	4/5	-75
256-QAM	5/6	-74

Table 3.7 Specified P_{ref} values expressed in dBm for a PLP, all signal bandwidths, guard intervals and 32k FFT for DVB-T2 signals (1).

3.4.4.7 Requirements for the signal quality indicator (SQI)

3.4.4.7.1 DVB-T signals

The terrestrial NorDig IRD shall be provided with a signal quality indicator (SQI). The value for the SQI shall be referred to the IRD RF signal input.

The absolute accuracy of the C/N value shall be of ± 1 dB for C/N values of 17 dB to 27 dB at the IRD RF signal input.

The signal quality indicator shall have a relative value within a range from 0% to 100% and with a resolution of 1%.

The signal quality indicator shall be updated regularly once per second.

The signal quality indicator (SQI) in [%] shall be calculated according to the following formulas.

$$\begin{aligned} \text{SQI} &= 0 && \text{if } C/N_{\text{rel}} < -7 \text{ dB} \\ \text{SQI} &= (((C/N_{\text{rel}} - 3)/10) + 1) * \text{BER_SQI} && \text{if } -7 \text{ dB} \leq C/N_{\text{rel}} < +3 \text{ dB} \\ \text{SQI} &= \text{BER_SQI} && \text{if } C/N_{\text{rel}} \geq +3 \text{ dB} \end{aligned}$$

where

C/N_{rel} is DVB-T mode depended of the relative C/N of the received signal value in [dB]

and

$$C/N_{\text{rel}} = C/N_{\text{rec}} - C/N_{\text{NordigP1}}$$

where

C/N_{NordigP1} is the required C/N value in [dB] for the non-hierarchical DVB-T mode in profile 1 defined in Table 3.10 for the hierarchical DVB-T modes, required C/N value in [dB] is specified in Annex B-3, Tables 1 and 2.

C/N_{rec} is the C/N value in [dB] of the received signal

BER_SQI is calculated with the formula

$$\begin{aligned} \text{BER_SQI} &= 0 && \text{if } \text{BER} > 10^{-3} \\ \text{BER_SQI} &= 20 * \text{LOG}_{10}(1/\text{BER}) - 40 && \text{if } 10^{-7} < \text{BER} \leq 10^{-3} \\ \text{BER_SQI} &= 100 && \text{if } \text{BER} \leq 10^{-7} \end{aligned}$$

where

BER is referenced to Bit Error rate after Viterbi and before Reed Solomon decoding.

The integration time for the BER_SQI calculation shall be over a period of 5 seconds.

3.4.4.7.2 DVB-T2 signals

The terrestrial NorDig IRD-T2 shall be provided with a signal quality indicator (SQI). The value for the SQI shall be referred to a PLP in the received signal at the NorDig IRD RF signal input.

The signal quality indicator shall have a relative value within a range from 0% to 100% and with a resolution of 1%.

The signal quality indicator shall be updated regularly at least once per second.

The signal quality indicator (SQI) in [%] shall be calculated for the received PLP according to the following formulas.

$$\begin{aligned} \text{SQI} &= 0 && \text{if } C/N_{\text{rel}} < -3 \text{ dB} \\ \text{SQI} &= (C/N_{\text{rel}} + 3) * \text{BER_SQI} && \text{if } -3 \text{ dB} \leq C/N_{\text{rel}} \leq 3 \text{ dB} \\ \text{SQI} &= 100 && \text{if } C/N_{\text{rel}} > 3 \text{ dB} \end{aligned}$$

where

C/N_{rel} is DVB-T2 mode depended of the relative C/N of the received signal value in [dB]

and

$$C/N_{\text{rel}} = C/N_{\text{rec}} - C/N_{\text{NordigP1}}$$

where

C/N_{rec} is the C/N value expressed in [dB] for the entire received DVB-T2 signal.

C/N_{NordigP1} is the required C/N value in [dB] for the received PLP in DVB-T2 mode independently of the pilot pattern in profile 1 defined in Table 3.11.

BER_SQI is calculated with the formula.

$$\begin{aligned} \text{BER_SQI} &= 0 && \text{if } \text{BER} > 10^{-4} \\ \text{BER_SQI} &= (100/15) && \text{if } 10^{-7} \leq \text{BER} \leq 10^{-4} \\ \text{BER_SQI} &= (100/6) && \text{if } \text{BER} < 10^{-7} \end{aligned}$$

where

BER is referenced to Bit Error rate before BCH for the received PLP.

The integration time for the BER calculation shall be over a period of 5 seconds.

3.4.5 Changes In Modulation Parameters

The terrestrial NorDig IRD should recover from changes in modulation parameters and output an error free TS. This should take less than one second for any change. The NorDig IRD should be able to detect a change of modulation parameters signalled in the TPS data of the DVB-T signal, in order to reduce the recovery time.

The terrestrial NorDig IRD-T2 shall automatically recover from changes in P1, L1 pre-signalling data and L1 post-signalling. An error-free TS shall be available within five seconds for any P1 and/or L1 pre-signalling change. An error-free TS shall be output within five seconds for any L1 post-signalling FEF change and within two seconds for any other L1 post-signalling change.

3.4.6 RF Input Connector

The terrestrial NorDig IRD shall have one input tuner connector, type: IEC female in accordance with IEC 61169-2 [39]. The input impedance shall be 75 ohm.

The RF input should support DC power to an external antenna with amplifier. This shall not degrade to the performance of the RF input characteristics. The DC power supply shall be protected against short circuit. Furthermore, there shall be an alternative in the menu system to turn the DC power supply source on/off. The last known state of the DC power supply source shall be set in the terrestrial NorDig IRD power up. In the first time initialisation and resetting to factory default settings, the DC power supply shall be switched off, see chapter 16.4.

If end-user has set state of the DC power supply to on, the terrestrial NorDig STB supporting RF loop through shall maintain that state on even when receiver is turned off to stand-by.

The DC power supply characteristics are specified in Table 3.8.

Parameter	Value
Voltage in ON state	+5.0VDC
Voltage tolerance	±0.2VDC
Maximum load current	30mA
Maximum load capacitance	100µF
Minimum resistance in OFF state	47kΩ
Protection for externally applied voltages	±15VDC

Table 3.8 RF input connector DC power supply characteristics.

3.4.7 RF Output Connector (option)

For a terrestrial NorDig IRDs equipped with a RF bypass (RF_{in} - RF_{out}), the connector shall be of type: IEC male in accordance with IEC 61169-2 [39].

The frequency range for the RF bypass should be from 47 MHz to 862 MHz.

The RF signals should be passed from RF_{in} to RF_{out} independently from the status of the NorDig IRD (operational or stand by), so that connected equipment (e.g. TV set) can operate even if the NorDig IRD is in stand by.

The terrestrial NorDig IRD, when equipped with RF bypass, shall (1) (2) include user setting to disable or enable the RF bypass gain in stand-by mode, see section 16.4 for factory default setting for this. When the RF bypass gain is disabled, the maximum RF bypass gain should -4dB and when the RF bypass gain is enabled, the RF bypass gain should be from -1 dB to +3 dB.

Note 1: Optional for IRDs that are launched before 1 July 2015.

Note 2: User setting is to distribute RF signal through the loop through without attenuating the RF signal significantly.

3.4.8 Time Interleaving

The terrestrial NorDig IRD-T2 shall at least include time interleaving capability corresponding to the maximum time interleaving according to EN 302 755 [21], i.e. $2^{19}+2^{15}$ OFDM cells for a data PLP and its common PLP together.

3.4.9 Input/Output Data Formats

The terrestrial NorDig IRD-T2 shall be able to support TS bit rates ≤ 72 Mbit/s.

Note: The maximum total input bitrate to the DVB-T2 system (considering the sum of all input streams) is therefore 72Mbit/s * 255. Thanks to the null packet deletion process most of this data is, however removed before transmission. The maximum input bit rate in terms of payload, taken over all input streams is limited by the T2 transmission capacity.

3.4.10 Performance

3.4.10.1 General

A wide set of performance requirements is defined for a limited set of DVB-T2 modes, see Table 3.9. A more limited set of performance requirements is defined for a wider set of DVB-T2 modes, as specified elsewhere in this section 3.4.10.

Note: The following performance requirements for DVB-T2 are based on computer simulations plus a reasonable implementation margin. The specified performance figures will be reviewed for a

future update of this specification, when more information about realistic receiver performance is available from laboratory and field tests. The review may result in modifications of the specified figures and in additional requirements.

	VHF III 7MHz SFN							VHF III 7MHz MFN			UHF 8MHz SFN					UHF 8MHz MFN	
Transmission mode	32K normal							32K normal			32K extended					32K extended	
Constellation	256-QAM rotated							256-QAM rotated			256-QAM rotated					256-QAM rotated	
Code rate	3/5	2/3	3/4	3/5	2/3	2/3	3/4	3/5	2/3	3/4	3/4	3/5	3/5	2/3	3/5	2/3	3/4
Guard interval	1/8 1/16	1/8 1/16	1/8 1/16	1/16 1/32	1/16 1/32	19/256	1/16 1/32	1/128	1/128	1/128	1/8	1/16 1/32	19/256	1/16 1/32	1/32	1/128	1/128
Pilot Pattern	PP2			PP4				PP7			PP2	PP4		PP6	PP7		
PAPR	TR-PAPR							TR-PAPR			TR-PAPR					TR-PAPR	
SISO/MISO	SISO							SISO			SISO					SISO	
FEC Frame length	64800							64800			64800					64800	
Input mode	Mode A							Mode A			Mode A					Mode A	
TFS	No							No			No					No	
Normal mode (NM)/high efficiency mode (HEM)	HEM							HEM			HEM					HEM	
FEF	Not used							Not used			Not used					Not used	
Auxiliary streams	Not used							Not used			Not used					Not used	

Table 3.9 A limited set of DVB-T2 modes for performance requirements (see note above).

3.4.10.2 Definitions

The performance requirements used in this section (3.4.10) are referring to the QEF definition provided in EN 300 744, where Quasi Error Free (QEF) means less than one uncorrected error event per hour. This requirement corresponds to $BER = 10^{-11}$ at the input of the MPEG-2 demultiplexer.

The performance refers to the entire frequency range (see section 3.4.2).

The carrier-to-noise (C/N) ratio in Table 3.10 (DVB-T) and Table 3.11 (DVB-T2), and minimum receiver signal input level (Pmin) values in Table 3.14 (DVB-T) and Table 3.15 (DVB-T2) are specified for two profiles:

Profile 1: Gaussian noise (N) is applied together with the wanted carrier (C) in a signal bandwidth of a DVB-T or DVB-T2 signal. No echo is applied.

Profile 2: The wanted signal (C) includes the direct path signal and an echo. The echo has the same power (0 dB echo) as the direct path signal and is delayed from 1.95 μ s to 0.95 times the guard interval length and has 0 degree phase at the channel center.

3.4.10.3 C/N Performance

The terrestrial NorDig IRD shall have at least the QEF performance for the C/N ratios given in, Table 3.10 (DVB-T) and Table 3.11 (DVB-T2).

Note: For DVB-T2 the required C/N for QEF and for error-free video are expected to be virtually identical due to the sharp waterfall characteristic of the LDPC+BCH decoding.

The C/N figures in Table 3.10 are derived as follows:

$$C/N = (C/N)_{\text{RAW}} + A + B + C + D \text{ [dB]}, \text{ where}$$

- $(C/N)_{\text{RAW}}$ = Required raw C/N for BER= 10^{-6} after BCH decoding, according to Annex E
- A = 0.1dB assumed additional C/N to achieve the BER= 10^{-7} before BCH decoding (assumed QEF transport stream after BCH decoding)
- B = correction for pilot boosting as defined in [68]
- C = 2.0 dB (PP1-PP2), 1.5 dB (PP3-PP4), 1.0 dB (PP5-PP8). Assumed C/N loss due to real channel estimation, imperfect LDPC decoding and other imperfections not considered part of the back-stop noise.
- D = additional C/N term corresponding to a back-stop noise level at -33 dBc. This term is derived by first calculating the sum of all terms, except D, and then check how much C/N degradation is caused by the -33 dBc backstop noise level. The term D is identical to this degradation. It should be noted that a change of pilot pattern from e.g. PP4 to PP2, which increases C from 1.5 dB to 2.0 dB, will also cause a slight increase of D.

For all other DVB-T2 modes the terrestrial NorDig IRD -T2 shall fulfil C/N requirements accordingly, based on this calculation scheme.

Note: The scheme above defines the required C/N for *all possible T2 configurations*. The C/N figures found in Table 3.10 and minimum power level figures found in Table 3.14 are only examples, applicable for a particular configuration. Changing pilot pattern from PP2 to something else will e.g. normally result in a change of required C/N and P_{min} .

Modulation	Code rate	C/N performance (dB)	
		Profile 1 : Gaussian	Profile 2 : 0 dB echo
QPSK	1/2	5.1	8.8
QPSK	2/3	6.9	13.7
QPSK	3/4	7.9	17.4
QPSK	5/6	8.9	-
QPSK	7/8	9.7	-
16-QAM	1/2	10.8	13.3
16-QAM	2/3	13.1	17.9
16-QAM	3/4	14.6	22.1
16-QAM	5/6	15.6	-
16-QAM	7/8	16.0	-
64-QAM	1/2	16.5	19.0
64-QAM	2/3	18.7	23.2
64-QAM	3/4	20.2	27.6
64-QAM	5/6	21.6	-
64-QAM	7/8	22.5	-

Table 3.10 Maximum required C/N for QEF reception at TS output (with 1/4 guard interval and FFT size 8K) for profiles 1 and 2

Modulation	Code rate	C/N performance (dB)	
		Profile 1 : Gaussian	Profile 2 : 0 dB echo
QPSK	1/2	3.5	5.2
QPSK	3/5	4.7	6.8
QPSK	2/3	5.6	8.4
QPSK	3/4	6.6	9.8
QPSK	4/5	7.2	-
QPSK	5/6	7.7	-
16-QAM	1/2	8.7	10.9
16-QAM	3/5	10.1	12.7
16-QAM	2/3	11.4	14.3
16-QAM	3/4	12.5	16.3
16-QAM	4/5	13.3	-
16-QAM	5/6	13.8	-
64-QAM	1/2	13.0	16.0
64-QAM	3/5	14.8	18.0
64-QAM	2/3	16.2	19.7
64-QAM	3/4	17.7	22.0
64-QAM	4/5	18.7	-
64-QAM	5/6	19.4	-
256-QAM	1/2	17.0	20.6
256-QAM	3/5	19.4	23.1
256-QAM	2/3	20.8	25.1
256-QAM	3/4	22.9	28.0
256-QAM	4/5	24.3	-
256-QAM	5/6	25.1	-

Table 3.11 Example of maximum required C/N for QEF reception at TS output (with 1/8 guard interval, PP2 and FFT size 32K) for profiles 1 and 2. For 1.7 MHz modes the C/N figures refer to 1/8 guard interval, PP2 and FFT size 8K with Normal bandwidth.

The required C/N, as defined above in Table 3.11, applies generally for Input Mode A (single PLP) and Input Mode B (multiple PLPs), including TFS (using 2-6 frequencies). For TFS, the level of all RF channels involved, are identical. For TFS, the 0 dB echo profile is also identical on all RF channels.

Note: Performance requirements for TFS modes with unequal levels and with other channel profiles may be defined in a later release of this specification.

3.4.10.4 Minimum Receiver Signal Input Levels

The terrestrial NorDig IRD shall have a noise figure (NF) for supported frequency ranges equal or better than the values specified in Table 3.12.

The terrestrial NorDig IRD-T2 shall have a noise figure (NF) for supported frequency ranges equal or better than the values in Table 3.13.

Note: The NorDig IRD noise figure refers to the noise figure of the complete receiver. In case of RF-loop-through the tuner NF will have to be somewhat better than the resulting NorDig IRD noise figure because of the attenuation of the RF-loop-through path.

	Band	Noise Figure (NF)
VHF	S Band I	10 dB
	VHF III	7 dB
	S Band II	10 dB
UHF	S Band III	10 dB
	UHF IV	7 dB
	UHF V	7 dB

Table 3.12 Maximum noise figures for the terrestrial NorDig IRD-T

	Band	Noise Figure (NF)
VHF	S Band I	10 dB
	VHF III	6 dB (1)
	S Band II	10 dB
UHF	S Band III	10 dB
	UHF IV	6 dB
	UHF V	6 dB

Table 3.13 Maximum noise figures for the terrestrial NorDig IRD-T2

Note 1: If 1.7 MHz bandwidth is supported (i.e. VHF band III) the NF shall be equal or better than 7 dB.

Comment: Thanks to the much better robustness of DVB-T2 (compared to DVB-T) against impulsive interference an improvement in noise figure is likely to have a much more positive effect on coverage with DVB-T2 than with DVB-T.

The terrestrial NorDig IRD shall provide QEF reception for the minimum signal levels (P_{\min}) for the supported frequency range as stated below (at 290K).

For 7 MHz Normal Bandwidth DVB-T/signal: $P_{\min} = -105.7 \text{ dBm} + \text{NF} [\text{dB}] + \text{C/N} [\text{dB}]$, and

For 8 MHz Normal Bandwidth DVB-T/T2signal: $P_{\min} = -105.2 \text{ dBm} + \text{NF} [\text{dB}] + \text{C/N} [\text{dB}]$ and

For 1.7 MHz Normal Bandwidth DVB-T2 signal: $P_{\min} = -112.1 \text{ dBm} + \text{NF} [\text{dB}] + \text{C/N} [\text{dB}]$, and

For 7 MHz Extended Bandwidth DVB-T2 signal: $P_{\min} = -105.7 \text{ dBm} + \text{NF} [\text{dB}] + \text{C/N} [\text{dB}]$, and

For 8 MHz Extended Bandwidth DVB-T2 signal: $P_{\min} = -105.1 \text{ dBm} + \text{NF} [\text{dB}] + \text{C/N} [\text{dB}]$, and

For 1.7 MHz Extended Bandwidth DVB-T2 signal: $P_{\min} = -112.1 \text{ dBm} + \text{NF} [\text{dB}] + \text{C/N} [\text{dB}]$,

where

P_{\min} values are listed in Table 3.14 (DVB-T) and examples of P_{\min} values are listed in Table 3.15 (DVB-T2) below as calculated from the equations above together with NF values in Table 3.12 and Table 3.13 plus C/N values in Table 3.10 (DVB-T) and Table 3.11 (DVB-T2). The values in Table 3.15 show the required P_{\min} values after 2011. For all other DVB-T2 modes the terrestrial NorDig IRD-T2 shall fulfil P_{\min} requirements accordingly, based on the formulas above.

		Minimum input level (dBm)					
		Profile 1: Gaussian				Profile 2: 0 dB echo	
Frequency band		VHF Band III	VHF S Band I & II	VHF S Band I & II and UHF S Band III	UHF Band IV&V	VHF Band III	UHF Band IV&V
Modulation	Code Rate	7 MHz signal	7 MHz signal	8 MHz signal	8 MHz signal	7 MHz signal	8 MHz signal
QPSK	1/2	-93.6	-90.6	-90.1	-93.1	-89.9	-89.4
QPSK	2/3	-91.8	-88.8	-88.3	-91.3	-85.0	-84.5
QPSK	3/4	-90.8	-87.8	-87.3	-90.3	-81.3	-80.8
QPSK	5/6	-89.8	-86.8	-86.3	-89.3	-	-
QPSK	7/8	-89.0	-86.0	-85.5	-88.5	-	-
16-QAM	1/2	-87.9	-84.9	-84.4	-87.4	-85.4	-84.9
16-QAM	2/3	-85.6	-82.6	-82.1	-85.1	-80.8	-80.3
16-QAM	3/4	-84.1	-81.1	-80.6	-83.6	-76.6	-76.1
16-QAM	5/6	-83.1	-80.1	-79.6	-82.6	-	-
16-QAM	7/8	-82.7	-79.7	-79.2	-82.2	-	-
64-QAM	1/2	-82.2	-79.2	-78.7	-81.7	-79.7	-79.2
64-QAM	2/3	-80.0	-77.0	-76.5	-79.5	-75.5	-75.0
64-QAM	3/4	-78.5	-75.5	-75.0	-78.0	-71.1	-70.6
64-QAM	5/6	-77.1	-74.1	-73.6	-76.6	-	-
64-QAM	7/8	-76.2	-73.2	-72.7	-75.7	-	-

Table 3.14 Minimum DVB-T signal input levels (P_{min}) for QEF reception at TS output (with 1/4 guard interval and FFT size 8K) for profiles 1 and 2.

		Minimum input level (dBm)							
		Profile 1: Gaussian					Profile 2: 0 dB echo		
Frequency band		VHF Band III		VHF S Band I & II	VHF S Band I & II and UHF S Band III	UHF Band IV&V	VHF Band III		UHF Band IV&V
Modulation	Code Rate	1.7 MHz signal	7 MHz signal	7 MHz signal	8 MHz signal	8 MHz signal	1.7 MHz signal	7 MHz signal	8 MHz signal
QPSK	1/2	-101.6	-96.2	-92.2	-91.6	-95.6	-99.9	-94.5	-93.9
QPSK	3/5	-100.4	-95.0	-91.0	-90.4	-94.4	-98.3	-92.9	-92.3
QPSK	2/3	-99.5	-94.1	-90.1	-89.5	-93.5	-96.7	-91.3	-90.7
QPSK	3/4	-98.5	-93.1	-89.1	-88.5	-92.5	-95.3	-89.9	-89.3
QPSK	4/5	-97.9	-92.5	-88.5	-87.9	-91.9	-	-	-
QPSK	5/6	-97.4	-92.0	-88.0	-87.4	-91.4	-	-	-
16-QAM	1/2	-96.4	-91.0	-87.0	-86.4	-90.4	-94.2	-88.8	-88.2
16-QAM	3/5	-95.0	-89.6	-85.6	-85.0	-89.0	-92.4	-87.0	-86.4
16-QAM	2/3	-93.7	-88.3	-84.3	-83.7	-87.7	-90.8	-85.4	-84.8
16-QAM	3/4	-92.6	-87.2	-83.2	-82.6	-86.6	-88.8	-83.4	-82.8
16-QAM	4/5	-91.8	-86.4	-82.4	-81.8	-85.8	-	-	-
16-QAM	5/6	-91.3	-85.9	-81.9	-81.3	-85.3	-	-	-
64-QAM	1/2	-92.1	-86.7	-82.7	-82.1	-86.1	-89.1	-83.7	-83.1
64-QAM	3/5	-90.3	-84.9	-80.9	-80.3	-84.3	-87.1	-81.7	-81.1

64-QAM	2/3	-88.9	-83.5	-79.5	-78.9	-82.9	-85.4	-80.0	-79.4
64-QAM	3/4	-87.4	-82.0	-78.0	-77.4	-81.4	-83.1	-77.7	-77.1
64-QAM	4/5	-86.4	-81.0	-77.0	-76.4	-80.4	-	-	-
64-QAM	5/6	-85.7	-80.3	-76.3	-75.7	-79.7	-	-	-
256-QAM	1/2	-88.1	-82.7	-78.7	-78.1	-82.1	-84.5	-79.1	-78.5
256-QAM	3/5	-85.7	-80.3	-76.3	-75.7	-79.7	-82.0	-76.6	-76.0
256-QAM	2/3	-84.3	-78.9	-74.9	-74.3	-78.3	-80.0	-74.6	-74.0
256-QAM	3/4	-82.2	-76.8	-72.8	-72.2	-76.2	-77.2	-71.7	-71.1
256-QAM	4/5	-80.8	-75.4	-71.4	-70.8	-74.8	-	-	-
256-QAM	5/6	-80.0	-74.6	-70.6	-70.0	-74.0	-	-	-

Table 3.15 Examples of minimum DVB-T2 signal input levels (P_{min}) for QEF reception at TS output (with 1/8 guard interval, PP2 and FFT size 32K, Extended bandwidth for UHF) for profiles 1 and 2. For 1.7 MHz modes the P_{min} figures refer to 1/8 guard interval, PP2 and FFT size 8K with Normal bandwidth(1).

Note 1: The P_{min} values for 1.7 MHz have been calculated using a NF of 7dB (See note 1 to Table 3.11).

The required P_{min} values shall apply generally for Mode A and Mode B, including TFS (1) (2), when supported.

For TFS, the levels of all RF channels involved are identical. For TFS, the 0 dB echo profile is also identical on all RF channels.

Note 1: Performance requirements for TFS modes with unequal levels and with other channel profiles may be defined in a later release of this specification.

3.4.10.5 Maximum Receiver Signal Input Levels

The terrestrial NorDig IRD shall provide QEF reception for DVB-T and DVB-T2 signals up to a level of -35dBm.

The DVB-T signal input level is valid for the modes {8K, 64-QAM, R=2/3, $\Delta/Tu=1/8$ }, {8K, 64-QAM, R=2/3, $\Delta/Tu = 1/4$ } and {8K, 64-QAM, R=3/4, $\Delta/Tu = 1/4$ }.

The DVB-T2 signal input level is valid for the modes shown in Table 3.9.

3.4.10.6 Immunity to “digital” signals in Other Channels

3.4.10.6.1 Immunity to DVB-T/-T2 signals in Other Channels

The terrestrial NorDig IRD shall, for the supported frequency ranges, permit an interfering DVB-T signal with a minimum interference to signal level ratio (I/C) as stated in the Table 3.16 while maintaining QEF reception.

Band	Signal Bandwidth MHz	Channel frequency raster MHz	Minimum I/C (dB)		
			Adjacent channels	Other Channels	Image channel
VHF S Band I	7	7	20	25	-
	8	8	20	25	-
VHF III	7	7	28	38	-
	8	8	28	38	-
VHF S Band II	7	7	20	25	-
	8	8	20	25	-
UHF S Band III	8	8	20	25	-

UHF IV	8	8	28	38	28
UHF V	8	8	28	38	28

Table 3.16 Minimum required I/C for QEF reception with interfering DVB-T/T2 signal on the adjacent, other and image channels

The requirements in this paragraph refer, for DVB-T, to the modes {8K, 64-QAM, R=2/3, Δ/Tu =1/8} and {8K, 64-QAM, R=2/3, Δ/Tu =1/4} and {8K, 64-QAM, R=3/4, Δ/Tu =1/4} and for DVB-T2 to the modes given in Table 3.9.

3.4.10.6.2 Immunity to 800MHz LTE signals in Other Channels

In many European countries UHF band V channels from CH61 to CH69, corresponding frequency range from 790 MHz to 862 MHz, are or will be allocated for mobile services. In these case the frequency range from 791 MHz to 821 MHz is used in LTE system for transmission from base station (BS) and frequency range from 832 MHz to 862 MHz is used for transmission from user equipment (UE). Allocated frequency ranges are divided into 6 x 5MHz blocks, but most common implementation is expected to use 2 x 5 MHz block and is therefore using 10 MHz system bandwidth of LTE signal. Frequency allocation is illustrated in figure below.

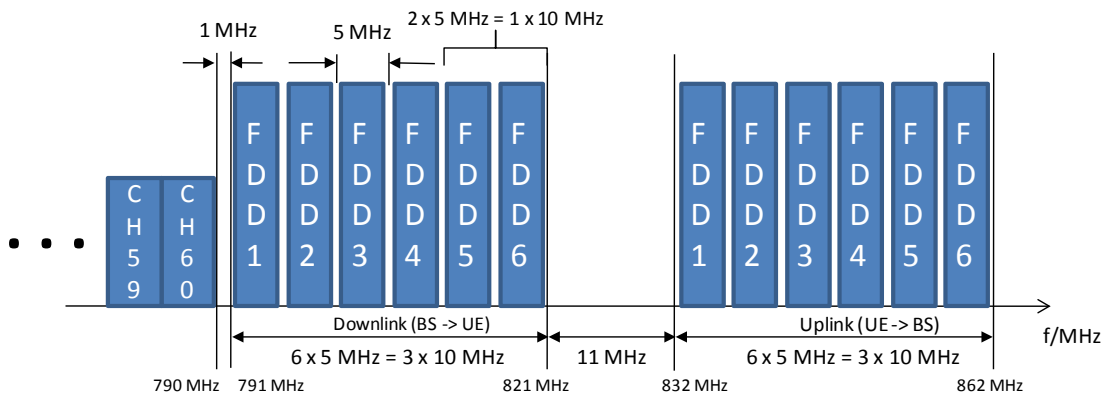

The terrestrial NorDig IRD and IRD-T2 shall, for the supported frequency ranges, permit an interfering 4G (LTE) signal with a minimum interference to signal level ratio (I/C) as stated in the Table 3.17 below while maintaining QEF reception.

The power of the LTE signal, both BS and UE, varies with a traffic load. The signal power of the LTE signal is defined as the power during the active part of the time varying LTE signal. The I/C values shall be fulfilled with LTE signals with a level of -15 dBm for the active part and all traffic loads from 0% to 100 % (BS) and for traffic loads from low bit rate to high bit rate (UE). Low traffic loads can be the most demanding ones.

Band	DVB-T/DVB-T2 channel	Signal Bandwidth MHz	Channel frequency raster MHz	Minimum I/C (dB)		
				10 MHz Downlink (FDD1&2)	10 MHz Downlink (FDD3&4, FDD5&6)	10 MHz Uplink (FDD1&2, FDD3&4, FDD5&6)
VHF III	K5-K12	7	7	40	40	40
UHF IV	K21-K37	8	8	40	40	40
UHF V	K38-K59	8	8	40	40	40
UHF V	K60	8	8	30	40	40

Table 3.17 Minimum required I/C for QEF reception with interfering LTE signal on the adjacent and other channels. I/C values are defined for LTE signals having signal bandwidth of 9.015 MHz in 10 MHz LTE system. I/C values for other signal bandwidths must be recalculated.

The requirements in this paragraph refer,

for DVB-T, to following modes {FFT size, modulation, code rate, guard interval, bandwidth};

- {FFT=8K, M=64-QAM, CR=2/3, GI =1/8, B=8MHz},
- {FFT=8K, M=64-QAM, CR=2/3, GI =1/4, B=8MHz} and
- {FFT=8K, M=64-QAM, CR=3/4, GI =1/4, B=8MHz}

and for DVB-T2 to the modes {FFT size, modulation, pilot pattern, code rate, guard interval, bandwidth}

- { FFT=32KE, M=256-QAM R, PP=4, CR=2/3, GI =1/16, 8MHz},
- { FFT=32KE, M=256-QAM R, PP=2, CR=3/4, GI =1/8, 8MHz},
- { FFT=32KE, M=256-QAM R, PP=4, CR=3/5, GI =19/256, 8MHz},
- { FFT=32KN, M=256-QAM R, PP=4, CR=2/3, GI =19/256, 7MHz} and
- { FFT=32KN, M=256-QAM R, PP=2, CR=3/4, GI =1/8, 7MHz}

FFT size 32KE refers to FFT size 32k with extended carrier mode, while 32KN refers to FFT size 32k with normal carrier mode. Modulation 256-QAM R refers to 256 QAM with rotated constellation.

3.4.10.7 Performance In Time-Varying Channels

The terrestrial NorDig IRD shall be able to operate with all signal time variations that naturally exist in connection with fixed roof-top reception (e.g. mast sway, antenna sway) and in-house portable reception (e.g. people walking around the receiving antenna). None of the above mentioned performance parameters should be significantly negatively affected when such channel time variations exist.

The increase in required C/N for QEF reception shall:

- not be higher (1) than 0 dB for a 0dB echo with frequency separation equal to 1 Hz and a delay of a 20 μ s, corresponding to a Doppler shift of +/- 0.5 Hz (after AFC), compared to the specified maximum required C/N for profile 2 in Table 3.10.
- be less than 3 dB for a 0 dB echo with frequency separation equal to 20 Hz and a delay of 20 μ s, corresponding to a Doppler shift of +/- 10 Hz (after AFC), compared to a 0 dB echo with frequency separation equal to 1 Hz and a delay of 20 μ s, corresponding to a Doppler shift of +/- 0.5 Hz (after AFC). The requirements in this paragraph refer for DVB-T to the modes {8K, 64-QAM, R=2/3, Δ /Tu =1/8} and {8K, 64-QAM, R=2/3, Δ /Tu =1/4}.

The increase in required C/N for QEF reception shall:

- not be higher (1) than 0 dB for a 0dB echo with frequency separation equal to 1 Hz and a delay of a 20 μ s, corresponding to a Doppler shift of +/- 0.5 Hz (after AFC), compared to the specified maximum required C/N for profile 2 in Table 3.10 and Table 3.11.
- be less than 3 dB for a 0 dB echo with frequency separation equal to 10 Hz and a delay of 20 μ s, corresponding to a Doppler shift of +/- 5 Hz (after AFC), compared to a 0 dB echo with frequency separation equal to 1 Hz and a delay of 20 μ s, corresponding to a Doppler shift of +/- 0.5 Hz (after AFC). The requirement in this paragraph refer for DVB-T to the mode {8K, 64-QAM, R=3/4, Δ /Tu =1/4} and for DVB-T2 to the modes given in Table 3.9 (1). For 1.7 MHz these DVB-T2 modes apply as well, except that the FFT size is 8K.

Note 1: Optional for IRDs that are launched before 1 July 2015.

3.4.10.8 Synchronisation for varying echo power levels in SFN

For the DVB-T modes {8K, 64-QAM, R=2/3, $\Delta/T_u=1/8$ }, {8K, 64-QAM, R=2/3, $\Delta/T_u=1/4$ } and {8K, 64-QAM, R=3/4, $\Delta/T_u=1/4$ }, the required C/N value, specified in Table 3.18 below, for QEF reception shall be obtained when the channel contains two paths with relative delay from 1.95 μ s up to 0.95 times guard interval length and the relative power levels of the two paths are dynamically varying including 0dB echo level crossing. The C/N value is defined at 0 dB level crossing.

For the DVB-T2 modes given in Table 3.9, the required C/N value, specified in Table 3.19 below, for QEF reception shall be obtained when the channel contains two paths with relative delay from 1.95 μ s up to 0.95 times guard interval length and the relative power levels of the two paths are dynamically varying including 0dB echo level crossing. The C/N value is defined at 0 dB level crossing.

Modulation	Code rate	C/N performance (dB)
64QAM	R2/3	26.2
64QAM	R3/4	30.6

Table 3.18 Maximum required C/N for QEF reception with dynamically varying echo power levels using DVB-T

Modulation	Code rate	C/N performance (dB)
256-QAM	R3/5	26.1
256-QAM	R2/3	28.1
256-QAM	R3/4	31.0

Table 3.19 Maximum required C/N for QEF with dynamically varying echo power levels using DVB-T2

3.4.10.9 C/(N+I) Performance in Single Frequency Networks

If there exists one or more FFT window positions for the time synchronisation that will give an aggregate available C/(N+I) larger than or equal to the required EPT (Effective Protection Target), the terrestrial NorDig IRD shall be able to find one of these positions, independently of echo profile. The terrestrial NorDig IRD shall also be able to correctly equalise the signal (referred to as Interval of correct equalization, T_F) for an echo range (i.e. distance from first to last echo) up to:

IRD-T:

- $7T_U/24$ (i.e. for 7 MHz signal up to 298 μ s and for 8 MHz signal up to 260 μ s),

IRD-T2:

- $57/64$ ($\approx 89.1\%$) of the Nyquist time (T_U/D_x) for the scattered pilots (after time interpolation) for a particular FFT size, pilot pattern and RF bandwidth.

independently of the echo profile. See also Annex B1.

Example: Using 32K, GI 1/16 (224 μ s) and PP4 it shall be possible to equalize echoes up to $(57/64) \cdot (3584/12) \mu$ s = 266 μ s.

For the DVB-T modes {8K, 64-QAM, R=2/3, $\Delta/T_u=1/8$ }, {8K, 64-QAM, R=2/3, $\Delta/T_u=1/4$ } and {8K, 64-QAM, R=3/4, $\Delta/T_u=1/4$ }, the required C/N value for profile 2 (specified in Table 3.10) for QEF reception shall be obtained when the channel contains two static paths with relative delay from 1.95 μ s up to 0.95 times guard interval length, independently of the relative amplitudes and phases of the two paths.

For the DVB-T2 modes shown in Table 3.9, the required C/N value for profile 2 (specified in Table 3.11) for QEF reception shall be obtained when the channel contains two static paths with relative delay from 1.95 μ s up to 0.95 times guard interval length, independently of the relative amplitudes and phases of the two paths. For 1.7 MHz these DVB-T2 modes apply as well, except that the FFT size is 8K.

For specific echo attenuation, the required C/N shall not be more than 1 dB higher compared to the median value when calculated for the required C/N values over the echo delays from 1.95 μ s up to 0.95 times guard interval length.

For echoes outside the guard interval, for:

- 8 MHz DVB-T signal, QEF reception shall be possible with echo levels up to the values defined in Table 3.20.
- 7 MHz DVB-T signal, QEF reception shall be possible with echo levels up to the values defined in Table 3.21.
- 8 MHz DVB-T2 signal, QEF reception shall be possible with echo levels up to the values defined in Table 3.22.
- 7 MHz DVB-T2 signal, QEF reception shall be possible with echo levels up to the values defined in Table 3.23.
- 1.7 MHz DVB-T2 signal, when supported, QEF reception shall be possible with combinations of delays and echo levels following the general outside-the-guard-interval behavior of Table 3.23, scaled appropriately for 1.7 MHz bandwidth and 8K FFT size.

This means that for 1.7 MHz bandwidth (i.e. elementary period $T=71/131 \mu$ s) and FFT size 8K, the symbol time will be 142/131 times longer (about a factor 1.084) compared to 32K in 7 MHz. The performance requirement for a given original echo level and delay shall therefore also be met when the delay is multiplied by 142/131, but the echo level is kept unchanged.

Delay (μ s)	Echo attenuation in dB relative reference									
	-260	-230	-200	-150	-120	120	150	200	230	260
Mode										
8K, 64-QAM, $R=2/3$, $\Delta T_u=1/8$	15	-	13	10	5	5	10	13	-	15
8K, 64-QAM, $R=2/3$, $\Delta T_u=1/4$	10	5	n/a	n/a	n/a	n/a	n/a	n/a	5	10
8K, 64-QAM, $R=3/4$, $\Delta T_u=1/4$	12	6	n/a	n/a	n/a	n/a	n/a	n/a	6	12

Table 3.20 QEF reception for echoes outside the guard interval, for 8 MHz DVB-T signal

Delay (μ s)	Echo attenuation in dB relative reference													
	-298	-266	-256	-215	-165	-135	-128	128	135	165	215	256	266	298
Mode														
8K, 64-QAM, $R=2/3$, $\Delta T_u=1/8$	16	-	-	13	10	5	1	1	5	10	13	-	-	16
8K, 64-QAM, $R=2/3$, $\Delta T_u=1/4$	10	5	1	n/a	n/a	n/a	n/a	n/a	n/a	n/a	n/a	1	5	10
8K, 64-QAM, $R=3/4$, $\Delta T_u=1/4$	12	6	2	n/a	n/a	n/a	n/a	n/a	n/a	n/a	n/a	2	6	12

Table 3.21 QEF reception for echoes outside the guard interval, for 7 MHz DVB-T signal.

Delay (µs)	Echo attenuation in dB relative reference									
	-260	-230	-200	-150	-120	120	150	200	230	260
Mode										
32K, 256-QAM, PP4, R=3/5, ΔTu=1/16,	4	2	n/a	n/a	n/a	n/a	n/a	n/a	2	4
32K, 256-QAM, PP4, R=2/3, ΔTu=1/16,	6	3	n/a	n/a	n/a	n/a	n/a	n/a	3	6
32K, 256-QAM, PP4, R=3/4, ΔTu=1/16	8	4	n/a	n/a	n/a	n/a	n/a	n/a	4	8
32K, 256-QAM, PP4, R=3/5, ΔTu=1/32	10	9	7	4	2	2	4	7	9	10
32K, 256-QAM, PP4, R=2/3, ΔTu=1/32	12	11	10	6	3	3	6	10	11	12
32K, 256-QAM, PP4, R=3/4, ΔTu=1/32	14	13	12	8	4	4	8	12	13	14

Table 3.22 QEF reception for echoes outside the guard interval, for 8 MHz DVB-T2 signal

Delay (µs)	Echo attenuation in dB relative reference							
	-/+608	-/+512	-/+400	-/+298	-/+266	-/+215	-/+165	-/+135
Mode								
32K, 256-QAM, PP4, R=3/5, ΔTu=1/16	n/a	n/a	n/a	4	2	n/a	n/a	n/a
32K, 256-QAM, PP4, R=2/3, ΔTu=1/16	n/a	n/a	n/a	6	3	n/a	n/a	n/a
32K, 256-QAM, PP4, R=3/4, ΔTu=1/16	n/a	n/a	n/a	8	4	n/a	n/a	n/a
32K, 256-QAM, PP4, R=3/5, ΔTu=1/32	n/a	n/a	n/a	10	9	7	4	2
32K, 256-QAM, PP4, R=2/3, ΔTu=1/32	n/a	n/a	n/a	12	11	10	6	3
32K, 256-QAM, PP4, R=3/4, ΔTu=1/32	n/a	n/a	n/a	14	13	12	8	4
32K, 256-QAM, PP2, R=3/5, ΔTu=1/16	12	11	9	4	2	n/a	n/a	n/a
32K, 256-QAM, PP2, R=2/3, ΔTu=1/16	15	14	11	6	3	n/a	n/a	n/a
32K, 256-QAM, PP2, R=3/4, ΔTu=1/16	18	16	14	8	4	n/a	n/a	n/a

Table 3.23 QEF reception for echoes outside the guard interval, for 7 MHz DVB-T2 signal

3.4.10.10 Time-Frequency Slicing (TFS)

The requirements in the remainder of this section 3.4.10.10 apply when TFS is supported:

For a particular LDPC code rate CR, $CR \in \{1/2, 3/5, 2/3, 3/4, 4/5, 5/6\}$, The terrestrial NorDig IRD-T2 shall in TFS mode be able to output a QEF TS when the proportion R of lost RF frequencies, of the total number of TFS RF frequencies, fulfils the relation $R \leq 0.75 \cdot (1 - CR)$ and the received RF frequencies have equal power and no noise, interference or echoes.

Example 1: Using TFS with 4 RF frequencies and CR=3/5 it shall be possible to lose one RF frequency since $1/4 = 0.25 < 0.75 \cdot (1 - 0.60) = 0.30$.

Example 2: Using TFS with 4 RF frequencies and $CR=2/3$ it shall be possible to lose one RF frequency since $\frac{1}{4} = 0.25 = 0.75 \cdot (1-2/3)$

The terrestrial NorDig IRD-T2 should be able to correctly demodulate a TS when TFS is performed on a combination of UHF band IV/V frequencies (8 MHz channel spacing) and VHF band III frequencies (7 MHz spacing) provided that the following conditions are fulfilled:

- The RF signals on VHF have nominally the same modulation parameters as those on UHF, including T2 frame length, symbol time, guard interval etc.
- The edge carriers on the VHF signal are symmetrically suppressed already from the transmitter (e.g. by setting the corresponding FFT bin values to zero) so that the actually transmitted RF bandwidth of the VHF signal is identical to a standard 7 MHz DVB-T2 signal.

Note 1: The terrestrial NorDig IRD-T2 should consider these edge carriers as unreliable. With two RF frequencies about 6.25% of the total number of TFS carriers would then be erased, which should have a very small impact on the capacity/robustness (required $C/N < 1$ dB degradation, but about corresponding increase in capacity), but with additional TFS gain.

Note 2: In a future release of this specification more detailed performance requirements for TFS operation may be included.

3.5 IP Based Front-End

3.5.1 General

The NorDig IRD shall include one IP-based front-end for reception of signals from, and interaction with, an IP-based network. The NorDig IRD shall be able to receive and decode DVB compliant signals and interact with other signals as specified below.

Note: DVB-IP is being updated by DVB; the update will be considered together with other issues for the IPTV-part of the NorDig Unified Requirements. The full IPTV-part is being reviewed, including this section 3.5 and section 13.4 (Service Discovery and Selection for IRDs with IP-based front-ends)

3.5.2 Network Interface

The IP-based network will provide signals with a maximum bit rate and other characteristics that are network dependant or set by the network operator, in accordance with NorDig Rules of Operations, ver 2.2 [63].

- The NorDig IRD shall accept RTP Packet Jitter up to 40 ms peak-to-peak ETSI TS 102 034 [31], section 7.2.1 / (ISO/IEC 13818-9).
- The NorDig IRD shall be able to receive an SPTS from the network with a speed of up to 20 Mbps.
- If the NorDig IRD is able to receive an MPTS from the network, it shall be able to receive such an MPTS with a speed of up to 60 Mbps.
- The NorDig IRD shall be able to transmit data to the network with a speed of at least 2 Mbps.
- The NorDig IRD shall use the protocols specified in section 3.5.3.

The physical interface to the IP-based network shall be an Ethernet port; compliant with IEEE 802.3 (100Base-T, Auto-sense). The physical connector shall be RJ45. The IRD shall have a female socket for the RJ45 male cable connector, see also section 8.3.

3.5.3 Protocol Suite

The NorDig IRD shall be able to handle protocols in compliance with ETSI TS 102 034 [31], Section 4.1.3, including support of IP, RTP and UDP.

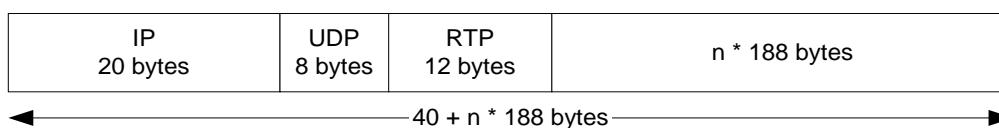

Figure 3.2 Transport stream protocol mapping.

The NorDig IRD should support RTCP [31]. When RTCP is used, the IRD shall not send receiver reports (and is thus restricted only to listen to sender reports).

The NorDig-IRD shall not require full duplex operation of the access network.

3.5.4 Dynamic Address Allocation

The NorDig IRDs shall be able to work with an IP address, subnet mask, default gateway, DNS server address and possibly WINS/NetBIOS server dynamically assigned from the network via DHCP.

Note: Static IP-addressing will not be used.

There shall be a DHCP client in the IRD that shall support all the messages of RFC 2131 [46] and RFC 2132 [47]. The DHCP client shall support client reconfiguration as defined in RFC 3203 [48], meaning that the “FORCERENEW” message shall be implemented to allow the DHCP server to reconfigure the IP address of NorDig IRD as part of Network Provisioning.

The client identifier shall be the MAC address of the network interface for NorDig IRD.

The DHCP client shall support all DHCP Options marked as ‘Mandatory’ ETSI TS 102 034 [31], section 8.1.1.4 and Table 17.

3.5.5 Service Selection

Service selection for IP based IRDs is specified in section 13.4.

4 MPEG-2 Demultiplexer

4.1 General

The Demultiplexer shall be compliant to the MPEG-2 transport layer defined in ISO/IEC 13818-1[52]. The NorDig IRD shall support ETSI TS 101 154 [28] and the additional requirements stated below:

- The NorDig IRD shall utilize the MPEG-2 Service Information as specified in Part B.
- The NorDig IRD shall interpret the CA descriptor as defined in ETSI ETR 289 [24].
- The NorDig SD IRD shall be able to decode an ISO/IEC 13818-1 [52] stream with data rates that include all rates up to that the front-end may deliver (1) as defined in chapter 3.
- It should be possible to select one or many section-based data streams and output them as data on USB (if present).
- The NorDig IRD shall be capable to utilise at least 32 elementary streams simultaneously, which requires 32 PID filters.
- The NorDig IRD shall provide at least 32 section filters (2).
- The NorDig IRD shall support variable bit rate elementary streams within a constant bit rate transport stream (excluding audio)
- The NorDig IRD shall support a mixture of service types within the same ISO/IEC 13818-1[52] MPEG-2 transport stream (i.e. MPEG-2 SDTV service, MPEG-4 AVC SDTV and HDTV and Radio services may be multiplexed into the same transport stream).

Note 1: The satellite front-end may deliver up to 80.4 Mbps after error correction, see section 3.2.2, note 1.

Note 2: This feature enables the NorDig IRD to utilise several components as video, audio teletext, SI, subtitling and data for additional services.

4.2 DVB Descrambler Performance (for IRD with embedded descrambling)

The descrambler unit is based on the common scrambling algorithm as specified by DVB, see DVB A 011 [4]. Common Scrambling Algorithms versions 2 and 3 shall (1) be implemented in the NorDig IRD. The algorithms are available from ETSI (2). See also section 9. It shall (1) be able to descramble on transport level and on PES format. The NorDig IRD shall (1) be able to process in parallel up to at least 6 different streams (either PES or transport level) with different access conditions. Data streams without access control shall be bypassed by the descrambling unit.

Note 1: See chapter 9. The DVB descrambler is mandatory for IRDs with a mandatory smart card interface for conditional access. The Common Scrambling Algorithm version 3 is mandatory for IRDs that are launched after 2011. Only mandatory for an IRD with embedded descrambling and a SmartCard Reader.

Note 2: ETSI acts as a neutral custodian for the distribution of the system information concerning the common scrambling system

4.3 System Clock Recovery

During the system time clock (STC) acquisition audio and video shall be muted. (The transition shall be smooth and seamless when the customer changes the channel). The decoder shall be able to:

- recover the STC using PCR with maximum jitter of $\pm 10 \mu\text{s}$.
- track long-term variations in the frequency of the encoder's STC.

For each service, the demultiplexer shall recover the source clock by extracting the associated PCR values received within the incoming multiplex and insert them into the appropriate Phase Locked Loop.

5 Video

5.1 General requirements

The NorDig IRD's video decoder shall fully comply with the DVB Implementation Guidelines for the use of MPEG-2 SDTV and H.264/AVC SDTV and HDTV video in satellite, cable and terrestrial broadcasting applications, ETSI TS 101 154 [28].

The following clauses of ETSI TS 101 154 [28] are relevant to this specification:

- 5.1; 25Hz MPEG-2 SDTV IRDs and Bitstreams
- 5.5; Specifications Common to all H.264/AVC IRDs and Bitstreams
- 5.6; H.264/AVC SDTV IRDs and Bitstreams. The minimum profile requirements for Nordig ID for SDTV content is High Profile at Level 3.0
- 5.7.1 and 5.7.2; H.264/AVC HDTV IRDs and Bitstreams, The minimum profile requirements for Nordig ID for HDTV content is High Profile at Level 4.0

5.1.1 Reference Model for Video Decoder

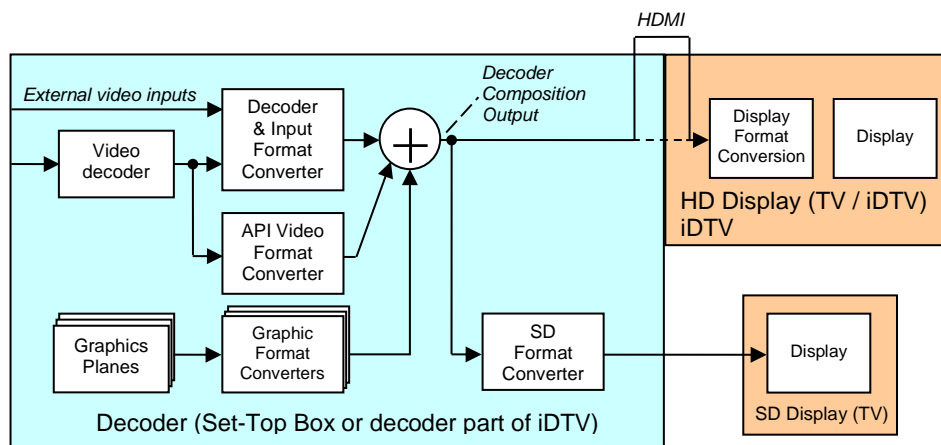

Figure 5.1 Reference Model for Video Decoder for the NorDig IRD

The Reference Model for Video Decoder for NorDig IRD is illustrated in Figure 5.1. It is a logical reference model and does not imply any specific implementation of an actual STB or iDTV.

5.2 Supported resolutions and frame rates

The Video Decoder shall (1) be able to receive and decode the video formats specified in Table 5.1.

Video Luminance Resolutions Hor. x Vert. (2)	Frame rate [Hz]	Progressive / Interlace	Source Aspect Ratio (Hor. : Vert)	Aspect_ratio_idc (AVC only)	Bit Stream (Profile@ Level)
1920x1080 (3)	25	I	16:9	1	AVC HP@L4
1920x1080	25	P	16:9	1	AVC HP@L4

1440x1080	25	P / I	16:9	14	AVC HP@L4
1280x1080	25	P / I	16:9	15	AVC HP@L4
960x1080	25	P / I	16:9	16	AVC HP@L4
1280x720 (3)	50	P	16:9	1	AVC HP@L4
960x720	50	P	16:9	14	AVC HP@L4
640x720	50	P	16:9	16	AVC HP@L4
720x576 (3)	25	I	4:3 16:9	2 4	AVC HP@L3 & MPEG-2 MP@ML
544x576	25	I	4:3 16:9	4 12	AVC HP@L3 & MPEG-2 MP@ML
480x576	25	I	4:3 16:9	10 6	AVC HP@L3 & MPEG-2 MP@ML
352x576	25	I	4:3 16:9	6 8	AVC HP@L3 & MPEG-2 MP@ML
352x288 (SIF)	25	I	4:3 16:9	2 4	AVC HP@L3 & MPEG-2 MP@ML

Table 5.1 Mandatory Video Formats to receive and decode

5.3 Up-sampling/Up-converting

Up-sampling of sub-sampled resolutions shall be made in accordance with ETSI TS 101 154 [28], i.e. sub-sampled luminance resolutions shall be up-converted by the Decoder Format Converter into the full video raster of the Decoder Composition Output, see Reference Model Figure 5.1

On the Decoder Composition Output the outgoing signal's video raster shall at all time be a full video with a raster of 1920x1080, 1280x720 or 720x576 according to selected settings. For an iDTV all resolutions shall be converted to the native resolution of the screen.

When up-converting video with an encoded luminance resolution of 720x576 or 704x576 to any 1:1 pixel aspect ratio format (i.e. 1280x720 or 1920x1080), only the centred 702 of the horizontal 720 / 704 pixels shall be used. Those 702 pixels correspond to the 52 microseconds of an active line, hence preserves correct geometry in the up-conversion process.

When up-converting other valid input line resolution format to any 1:1 pixel aspect (output) format (i.e. 1280x720 or 1920x1080), only the centred horizontal pixels shall be used; e.g. when up-converting (received) 544x576 line resolution format to any 1:1 pixel aspect ratio (output) format, only the centred 530 pixels of the horizontal 544 shall be used.

5.4 Colorimetry

The Decoder Format Converter shall use the VUI (Video Usability Information) parameters (ISO/IEC 14496-10)[56] *colour_primaries*, *transfer_characteristics* and *matrix_coefficients* in received AVC encoded bitstreams and the Sequence Display Extension parameters (ISO/IEC 13818-2) [53] in MPEG-2 encoded bitstreams.

The “Decoder Composition Output” shall output video with colour parameters targeting an ideal display, optimised for each video format.

Table 5.2 below gives the documentation where to find appropriate chromaticity co-ordinates, opto-electronic transfer characteristics and matrix coefficients to be used when deriving luminance and chrominance signals from the red, green and blue primaries (or vice versa, i.e. YCbCr to RGB):

Active composition resolution in the “Decoder Composition Output” (Horizontal x Vertical)	Documentation for appropriate Colour Processing	Comments
720x576	ITU-R BT.1700 (replaces ITU-R BT.470 System B, G)	Note that 576 lines in both interlaced scan (576i) and progressive scan (576p) shall be processed and output with equal colour parameters.
1280x720	ITU-R BT.1847 (SMPTE 296M)	The colour parameters in SMPTE 296M are the same as in ITU-R BT.709.
1920x1080	ITU-R BT.709 (SMPTE 274M)	The colour parameters in SMPTE 274M are the same as in ITU-R BT.709.

Table 5.2 Documentation for appropriate Colour Processing

5.5 Dynamic changes in the video stream

The NorDig IRD shall be able to handle dynamic changes to either the codec or the video mode that may occur dynamically within the transmitted stream. In the case of a codec change, this is defined to mean a change between MPEG-2 and H.264/AVC.

After a change of video codec between MPEG-2 and H.264/AVC, the IRD should automatically resume decoding and output of valid video within five seconds.

The NorDig IRD shall be able to handle dynamic changes in transmission between different video formats and frame rates (e.g. 720p50 to 1080i25/1080p25 and 576i25 to 720p50), including changes in encoded sub resolution (e.g. 720x576 to 544x576) within one second after receiving Random Access Point. (Random Access Point equals AVC RAP for H.264/AVC and Sequence header for MPEG-2).

The Nordic IRD shall adapt to changes in transmitted aspect ratio (e.g. 16:9 / 4:3) within one second after the reception. The transition shall cause minimal disturbance of the decoded service.

5.6 AVC still picture

By still picture means broadcast of only intra coded frames at very low frame rate (typical 1 frame per second). The NorDig IRD shall decode this still picture frame and repeat displaying this until next (still picture) frame is available to display.

The NorDig IRD shall support still picture for the h.264/AVC profiles main and high.

The AVC still picture video stream is defined to consist of the following NAL (Network Abstraction Layer) units:

- Access unit delimiter (NAL unit type 9)
- Sequence Parameter Set (NAL unit type 7)
 - Fixed_frame_rate_flag set to 0
- Picture Parameter Set (NAL unit type 8)
- Supplemental enhancement information (NAL unit type 6)
- Coded slice of an IDR picture (NAL unit type 5)
- End of sequence (NAL unit type 10)
- (If needed) Filler data (NAL unit type 12)

For the signalling of the AVC still picture the AVC video-descriptor will be used (in PMT) as specified in MPEG-2 Systems (ISO/IEC 13818-1 [52] and TS 101154 v1.10.1 [29]). The flag `AVC_still_present` will be set to 1.

5.7 Minimum video bandwidth

The NorDig IRD shall provide support for very low bandwidth video.

For MPEG-2 video the decoder shall be able to decode at bit rates down to 1.0 Mbps for video resolutions up to full Standard Definition resolution video (720x576).

The NorDig IRD shall be able to decode H.264/AVC video at bitrates down to 250 kbps for all resolutions up to 1920x1080. For AVC still picture the NorDig IRD shall be able to decode down to 100 kbps.

5.8 Frame Cropping

The NorDig IRD shall support frame cropping for H.264/AVC encoded video. Frame cropping signalling is used to indicate which area of the encoded video that should be displayed.

For 1080 line formats, the video is encoded with 1088 lines. To indicate which area of the encoded video that should be displayed, frame cropping signalling may be used. If frame cropping information is included in the encoded video, this shall be used to decide which 8 lines should be hidden in the Decoder Composition Output. If no frame cropping signalling is available, the IRD shall crop the bottom 8 lines.

5.9 Overscan

For services carrying H.264/AVC video, the broadcaster may use the `overscan_info_present` and `overscan_appropriate` flags to indicate whether the receiver should apply this typical overscan or should display the complete broadcast video image. The flags will be encoded according to Table 5.3.

<code>overscan_info_present_flag</code>	<code>Overscan_appropriate_flag</code>	Usage
0x0 or not broadcast	n/a	No preferred display method
0x1	0x0	Important information in entire video region
0x1	0x1	Decoded picture suitable for overscan

Table 5.3 Broadcast overscan flag

Unless the user requests otherwise, NorDig IRDs shall interpret and follow the overscan flags according to Table 5.4.

<code>overscan_info_present_flag</code>	<code>overscan_appropriate_flag</code>	Behaviour
0x0 or not broadcast	n/a	Implementation dependent
0x1	0x0	Overscan not applied
0x1	0x1	Overscan applied

Table 5.4 Receiver overscan behaviour

The NorDig STBs shall pass the video unaltered, i. e. without overscan related reformatting to its HDMI output, setting the bits in the AVI Infoframe (see CEA 861 [3]) in accordance with Table 5.5.

overscan_info_present_flag	overscan_appropriate_flag	<S1,S0> (in HDMI AVI Infoframe)
0x0 or not broadcast	n/a	<0,0>
0x1	0x0	<1,0>
0x1	0x1	<0,1>

Table 5.5 Overscan signalling on HDMI

Most displays have a user option where it will display the full frame of 1080 line based video formats without any overscan applied. It is recommended that the Nordig iDTVs support such user option to achieve one-to-one pixel mapping on 1920 x 1080 resolution displays. Note that the user, if overriding the received overscan flags, may not see a clean aperture as content producers can not promise artefact free areas outside the Action Safe Area described in “EBU – Recommendation R95, Safe areas for 16:9 television production” [76].

5.9.1 Safe area for overscan

The amount of applied overscan shall not be in conflict with the broadcasted Action Safe Areas. Please refer to “EBU – Recommendation R95, Safe areas for 16:9 television production” [76] for appropriate guidelines.

5.10 High Definition Video Output and Display

The NorDig STBs shall be able to use the EDID information provided by the display to determine automatically the STB output and to accept a manual setting of the STB output, as specified in section 8.6.

For NorDig iDTVs the output video shall always be converted to the display’s native resolution.

5.11 Down-conversion of High Definition Video for Standard Definition output

If SCART, or any other analogue video output (Y, P_b, P_r, RF-PAL or CVBS) is available, the decoded High Definition video shall be down-converted by the SD Format Converter to Standard Definition resolution for output via these interfaces.

Down-conversion of pictures shall be implemented, from any of the incoming encoded HD full screen luminance resolution values (1920x1080, 1440x1080, 1280x1080, 960x1080, 1280x720, 960x720 and 640x720) to SD resolution (720x576).

When down-converting any 1:1 pixel aspect ratio format (i.e. 1280x720 or 1920x1080) in the Decoder Composition Output to 720x576 resolution, the target shall be 702x576 pixels to be centred in the 720x576 grid with nine black pixels inserted as the start of the 720 pixel active line and nine black pixels inserted as the end of the 720 pixel active line.

Down-converted HD video shall be displayed as 16:9 letterbox on 4:3 displays. 4:3 centre-cut is *not* an allowed display option, since this would limit the Action Safe Area in HD program production.

The SD Format Converter should apply appropriate re-interlacing (field mode integration re-interlacing). It shall process and output 720x576i25 in 4:3 frame aspect ratio or 16:9 frame aspect ratio video with colours according to 5.4 Colorimetry.

5.12 Display Format for other Aspect Ratios

The Nordig IRDs shall have methods to display 16:9 transmitted content on a 4:3 monitor. Likewise Nordig IRDs and iDTVs shall have methods to display 4:3 transmitted content on a 16:9 monitor. The user shall have the ability to select appropriate aspect ratio for the analogue video output (SCART), see section 8.4.

Transmitted Aspect Ratio	16:9 Monitor	4:3 Monitor
16:9	As original	16:9 aspect ratio maintained (Letterbox).
4:3	Full high 4:3 aspect ratio maintained (Pillarbox)	As original

Table 5.6 Mandatory display modes

5.13 Rescaling for HbbTV application

A NorDig Hybrid shall support rescaling as defined in HbbTV under “video scaling” in clause 10.2.1 of ETSI TS 102 796 V1.2.1 [30]. These shall be supported for any of the valid incoming encoded full screen luminance resolution (see 5.2 for full screen luminance resolution values). The video shall be scaled, preserving the aspect ratio, such that all of the decoded video is visible within the area of the AV Control object. (See HbbTV requirements in ETSI TS 102 796 [30] Appendix E4).

6 Audio

6.1 General

Former NorDig Unified Specifications (v 2.2.1 and earlier) was separated into M2 Level and M4 Level in the audio chapter. The new NorDig Unified Specification v 2.3 has unified the M2 and M4 Level into one audio specification.

NorDig has defined three audio decoder formats:

- **MPEG 1 Layer II**, which refers to MPEG-1 Layer II up to stereo (2.0) channel decoding [55]. (Might be used for MPEG-2 based services).
- **E-AC-3**, which refers to E-AC-3 streams (including **AC-3**) up to 5.1 multi-channel decoding [35]. (Might be used for MPEG-4 based services).
- **HE-AAC**, which refers to MPEG-4 HE-AAC Level 4 (including AAC-LC) up to 5.1 multi-channel decoding [55]. (Might be used for MPEG-4 based services).

Regarding the audio decoder (“codec”), the NorDig IRD shall meet all the audio codec requirements specified by the network(s) for where the NorDig IRD is intended to be used, see below (i.e. the audio codec requirements might slightly differ from one NorDig network to another)

(Informative: Some NorDig networks has aligned all (MPEG-4) services into always using HE-AAC and some other networks has aligned all (MPEG-4) services into always using E-AC-3 or AC-3, this among other things to limit the number of audio decoders in the IRDs and in some cases also to save broadcast capacity. However some NorDig networks are using HE-AAC for some (MPEG-4) services and E-AC-3/AC-3 for some other of their (MPEG-4) services).

In NorDig networks/regions where there is no single operator for acceptance of the IRDs, the NorDig IRD shall support:

- MPEG-1 Layer II and E-AC-3 and HE-AAC audio decoding.

In NorDig networks/regions where there is a single operator/regulator in charge for specifying the functionality of the IRD and ensuring that the minimum requirements are met, the operator/regulator specifies one of following minimum audio decoding format alternatives for the NorDig IRD to minimum support for that relevant network (i.e. always minimum two audio decoders):

- MPEG-1 Layer II and E-AC-3 and HE-AAC audio decoding,
- MPEG-1 Layer II and E-AC-3 audio decoding,
- MPEG-1 Layer II and HE-AAC audio decoding.

The Audio decoders shall fully comply with the DVB Implementation Guidelines for the use of MPEG-2 Systems, Video and Audio in satellite, cable and terrestrial Broadcasting Applications ETSI TS 101 154 [28].

6.1.1 Audio User Preference Settings

The NorDig IRD shall have User Preference Settings for audio functions as stated in section 16.2 (for example primary and secondary audio language, audio format, audio type, audio delay, etc).

6.1.2 Audio terminology

“Normal” audio refers in this specification to audio streams that are:

- intended for the majority of users and users that are not interested in any supplementary audio and
- signalled in the supplementary audio descriptor by `mix_type` ‘1’ and editorial description ‘0’ and in the ISO 639 language descriptor with `audio_type` ‘undefined’ and language not set to ‘nar’.

A Supplementary Audio (SA) service may be either:

- Audio description: audio that includes a narration describing the action of the scene and is targeted at users with visual or cognitive impairments (see section 6.11 for more information).
- Spoken subtitling: audio that includes a spoken rendition of the subtitles and is targeted at users with visual or cognitive impairments (see section 6.11 for more information).
- Clean audio: functionality that provides improved intelligibility. It is targeted at users with hearing impairments, but can as well serve as improvement for listening in noisy environments (see section 6.10 for more information).

6.2 Audio Decoding

For NorDig IRD's User Preference Settings for audio functions see section 6.1.1

The majority of customer installed base of home theatre systems are not able to decode the newer E-AC-3 and HE-AAC formats. Therefore, the NorDig IRD shall be able to “transcode” audio streams as stated in sections 6.2.2.1 and 6.2.3.1.

6.2.1 MPEG-1 Layer II: Requirements on Audio Handling

6.2.1.1 MPEG-1 Layer II: Decoding

The NorDig IRD shall support:

- decode MPEG-1 Layer II streams at all bit rates and sample rates listed in ETSI TS 101 154 [28].

The NorDig IRD should support:

- decode MPEG-1 Layer II streams at half-sampling rates (22.05 and 24 kHz).

6.2.1.2 MPEG-1 Layer II: Audio Output

The NorDig IRD shall be capable of providing the following formats on the HDMI output connector from an MPEG-1 Layer II bitstream (see section 16 for factory default settings):

- Decoded to PCM stereo bitstream.

The NorDig IRD including an S/PDIF output shall be capable of providing the following formats on the S/PDIF connector from an MPEG-1 Layer II bitstream:

- Decoded to PCM stereo bitstream

6.2.2 E-AC-3 and AC-3: Requirements on Audio Handling

6.2.2.1 E-AC-3 and AC-3: All Pass-through, Decoding and Transcoding

NorDig IRD supporting E-AC-3 and AC-3 shall

- decode AC-3 streams at all bit rates and sample rates listed in ETSI TS 102 366 [35] (not including Annex E).
- (additionally) decode E-AC-3 streams with data rates from 32 kbps to 3 024 kbps and support all sample rates listed in TS 102 366 [35] Annex E.
- be capable of transcoding E-AC-3 bitstreams to AC-3 bitstreams according to TS 102 366 [35]. Transcoding to AC-3 audio streams shall be at a fixed bit rate of 640 kbps.

6.2.2.2 E-AC-3 and AC-3: Metadata

The NorDig IRD supporting E-AC-3 and AC-3 shall support the use of a complete set of Dolby metadata [35] embedded in the audio stream when decoding AC-3 or E-AC-3 bitstreams, transcoding E-AC-3 bitstreams to AC-3, or creating a PCM stereo downmix from a decoded E-AC-3 or AC-3 bitstream. (1) (2)

Note 1: The E-AC-3 and AC-3 encoders always adds default metadata if they are not fed with metadata.

Note 2: NorDig has the intension to include more information in the future in the NorDig Rules of Operation about the inclusion of metadata for E-AC-3 and AC-3.

6.2.2.3 E-AC-3 and AC-3: Audio Output

NorDig IRDs supporting E-AC-3 and AC-3 shall be capable of providing the following formats on the HDMI output connector connector from an E-AC-3 or AC-3 bitstream (see chapter 16 for factory default settings):

- Pass-through of native bitstream (AC-3 and E-AC-3).
- E-AC-3 bitstream transcoded to AC-3 bitstream.
- Decoded and downmixed (if > 2 channels) to PCM stereo bitstream

The following formats should be provided for the HDMI output connector from an E-AC-3 or AC-3 bitstream:

- Decoded to PCM multichannel bitstream.

The NorDig IRD supporting E-AC-3 and AC-3 and including an S/PDIF output shall be capable of providing the following formats on the S/PDIF connector from an E-AC-3 or AC-3 bitstream:

- E-AC-3 bitstream transcoded to AC-3 bitstream
- Decoded and downmixed (if > 2 channels) to PCM stereo bitstream
- Pass-through of AC-3 bitstream

6.2.3 HE-AAC: Requirements on Audio Handling

6.2.3.1 HE-AAC: All Pass-through, Decoding and Transcoding

NorDig IRDs supporting HE-AAC (and thereby also AAC-LC) shall be capable of:

- decoding HE-AAC Version 1 at Level 2 at sampling rates of 48 kHz according to ETSI TS 101 154 [28].
- decoding, including downmixing HE-AAC Version 1 at Level 4 (multi-channel, up to 5.1) at sampling rates of 48 kHz according to ETSI TS 101 154 [28], Annex C (downmix).
- transcoding HE-AAC Version 1 at Level 4 (multi-channel, up to 5.1) at sampling rates of 48 kHz according to TS 101 154 [28], Annex H to AC-3 or DTS.

Nordig IRDs shall be able to skip bitstream elements that are not recognized, i.e. unknown Fill elements and Data Stream elements.

If NorDig IRD is supporting HE-AAC audio stream transcoding to AC-3 audio stream, it shall be done according to TS 102 366 [35]. Transcoding to AC-3 multichannel audio streams shall be at a fixed bit rate of 640 kbps.

If NorDig IRD is supporting HE-AAC audio stream transcoding to DTS audio stream, it shall be done according to TS 102 114 [32] at a fixed bit rate of 1,536 Mbps.

6.2.3.2 HE-AAC: Metadata

The NorDig IRD supporting HE-AAC shall support decoding of HE-AAC bitstreams both with and without audio metadata. It is highly recommended that the broadcast includes metadata for

all HE-AAC bitstream, (NorDig has the intension to include more information in the future in the NorDig Rules of Operation about the inclusion of metadata for HE-AAC).

The NorDig IRD supporting HE-AAC shall support the use of the following MPEG-4 AAC metadata embedded in the audio stream when decoding HE-AAC and transcoding HE-AAC multi-channel to AC-3 or DTS:

- Program Reference Level according to ISO/IEC 14496-3 [55] (prog_ref_level)
- Downmix Parameters according to "Transmission of MPEG4 Ancillary Data" part of DVB specification ETSI TS 101 154 [28] (center_mix_level, surround_mix_level)
- DRC Presentation Mode according to ETSI TS 101 154 Annex C.5.2.2.3 (drc_presentation_mode) (see note 1)
- Dynamic Range Control (DRC) according to ISO/IEC 14496-3 [55] (dyn_rng_sgn, dyn_rng_ctl)
- Heavy Compression according to ETSI TS 101 154 Annex C.5.2.5 (compression_on, compression_value)

The NorDig IRD capable of transcoding metadata to their output format shall not alter the level of the audio contained within the bitstream, shall pass all audio channels and shall transcode all metadata to the output format.

The NorDig IRDs that are transcoding the incoming audio with metadata to an output format without metadata, shall apply the incoming metadata before the transcoding.

For HE-AAC bitstreams without metadata the NorDig IRD shall interpret that the bitstream uses default metadata values (for decoding and any transcoding) according to ETSI TS 101 154 chapter C.5.2.8 Table C.31 'Persistence of MPEG4 ancillary data' (1). In the absence of Program Reference Level metadata, it shall be assumed to be -23 dBFS (for mono, stereo and multichannel audio).

It is up to the broadcaster to ensure that sufficient headroom and/or dynamic range control values are included in the transmission to prevent any overload when downmixing.

Note 1: Optional for the NorDig IRDs released before 1 July 2015
--

6.2.3.3 HE-AAC: Audio Output

NorDig IRDs supporting HE-AAC shall be capable of providing the following formats on the HDMI output connector from a HE-AAC bitstream (see chapter 16 for factory default settings):

- Transcoded to AC-3 or DTS bitstream.
- Decoded and downmixed (if > 2 channels) to PCM stereo bitstream.

NorDig IRDs supporting HE-AAC should be capable of providing the following formats on the HDMI output connector from a HE-AAC bitstream (see chapter 16 for factory default settings):

- Pass-through of native bitstream (HE-AAC) (1).
- Decoded to PCM multichannel bitstream.

Note 1: HE-AAC over HDMI is defined in HMDI 2.0 specification.
--

The NorDig IRD supporting HE-AAC and including an S/PDIF output shall be capable of providing the following formats on the S/PDIF connector from a HE-AAC bitstream:

- Decoded and downmixed (if > 2 channels) to PCM stereo bitstream
- Transcoded to AC-3 or DTS bitstream

6.3 Multichannel Audio

Multichannel audio is defined as an audio stream with more than two channels of audio.

The NorDig IRD should be able to output an audio stream as non-PCM encoded audio if there is a multichannel audio stream present for the chosen service in the incoming transport stream.

The multi-channel audio shall be decoded to a stereo downmix under the control of the format indicated in the preferred stereo down-mix parameter in the audio metadata, i.e. a matrix encoded compatible stereo downmix (Lt/Rt signal) or to a normal stereo down-mix (Lo/Ro signal), and shall be fed to the (stereo) analogue output connectors (SCART, RCA, headphones output and/or built-in loudspeakers if present).

If audio does not include any preferred stereo down-mix parameter in the audio metadata, the factory default method should be according to ETSI TS 101 154 [28], Annex C.5.2.4 (Lo/Ro) for AAC. For AC-3 and E-AC-3, there is always audio metadata included together with the audio bitstream.

The choice and priority between different stereo audio streams, and downmixed multichannel audio streams for the analogue outputs shall then be as specified in section 6.5 (Audio prioritising). When multichannel audio (AC-3, E-AC-3, HE-AAC) is present, it is recommended to show a visual indication.

See more details in section 6.5 Audio Prioritising and section 6.8.2 Digital Audio Output (HDMI, HDMI ARC and S/PDIF).

6.4 Stereo Audio

The NorDig IRD shall be able to output an audio stream as PCM encoded audio if there is a stereo or mono audio stream present for the chosen service in the incoming transport stream. It is optional to transcode the incoming audio stream to AC-3 or DTS.

See more details in section 6.5 Audio Prioritising and section 6.8.2 Digital Audio Output (HDMI, HDMI ARC and S/PDIF).

6.5 Audio Prioritising

The NorDig IRD shall be able to select audio stream according to user selections. In addition, the user shall be able to manually select between all audio streams that are associated with the active service, these settings should be stored in the IRD's memory separately for each service.

If manually selected audio is not able to be stored in the IRD's memory per service, a global setting should be made possible to set manual prioritisation of stream type for all services. The priority for the selected audio source shall be based on the user selections and audio stream shall be selected according to the priority list in table 6.1 below. (See section 0 for requirements of audio user preference settings for the NorDig IRD).

If the user selections are not matching with the audio streams, the NorDig IRD shall always select one of the audio streams which closest suites with the user selections and will hereby provide audio to end-user.

The following Table 6.1 shows audio source priority based on the property of the supported audio streams and for different user preference settings of audio format and audio type as selected by the user, see section 16.4 for factory default user preference settings related to audio.

IRD settings →		“Normal” audio mode		Supplementary audio mode	
		stereo mode (factory default)	multichannel mode	stereo mode	multichannel mode
IRD behaviour depending on above IRD settings					
Property of priority for audio	Priority	Order of priority			
Audio type	1 (highest)	1.1 “normal” 1.2 supplementary audio	1.1 “normal” 1.2 Supplementary audio	1.1 supplementary audio 1.2 “normal”	1.1 supplementary audio 1.2 “normal”
Language	2	2.1 audio match primay audio language settings 2.2 audio match secondary audio language settings 2.3 (if no match) “normal” audio 2.4 (if no “normal” audio) any audio	2.1 audio match primay audio language settings 2.2 audio match secondary audio language settings 2.3 (if no match) “normal” audio 2.4 (if no “normal” audio) any audio	2.1 supplementary audio match primay audio language settings 2.2 supplementary audio match secondary audio language settings 2.3 (if no match) “normal” audio 2.4 (if no “normal” audio) any audio	2.1 supplementary audio match primay audio language settings 2.2 supplementary audio match secondary audio language settings 2.3 (if no match) “normal” audio 2.4 (if no “normal” audio) any audio
Audio format	3	3.1 stereo 3.2 Multichannel 3.3 mono	3.1 Multichannel 3.2 stereo 3.3 mono	3.1 stereo 3.2 Multichannel 3.3 mono	3.1 Multichannel 3.2 stereo 3.3 mono
Stream type	4 (lowest)	4.1 MPEG-1 Layer II 4.2 HE-AAC 4.3 E-AC-3 4.4 AC-3	4.1 HE-AAC 4.2 E-AC-3 4.3 AC-3 4.4 MPEG-1 Layer II	4.1 MPEG-1 Layer II 4.2 HE-AAC 4.3 E-AC-3 4.4 AC-3	4.1 HE-AAC 4.2 E-AC-3 4.3 AC-3 4.4 MPEG-1 Layer II

Table 6.1 Audio Priority between incoming audio streams where a lower number refers to higher priority.

Note: NorDig IRD released before 1 July 2015 may still use old priority order with Lanugue higher priority than Audio type.

6.5.1 Audio Prioritising, Type (“Normal” or supplementary)

If “Normal” audio type is selected, the NorDig IRD shall only use audio stream of types other than “Normal” if no “Normal” audio is available at input for the selected service (see 6.1.2 for definition of “Normal” audio).

If Supplementary audio type is selected, the NorDig IRD shall prioritise Supplementary Audio streams for the selected service that has language matching user preference settings for primary and secondary audio language. If the selected service has no Supplementary Audio with a language matching IRD’s user preference settings for either primary or secondary audio language, the NorDig IRD shall instead priotise “Normal” audio (before any Supplementary audio with a language not matching audio language preferences).

Note 1: Optional for NorDig IRD released before 1 July 2015.

6.5.2 Audio Prioritising, Languages

If an audio stream according to the primary audio language preference is not associated with the chosen service the NorDig IRD shall automatically choose the audio stream according to the secondary audio language preference, if present.

6.5.3 Audio Prioritising, Format (multichannel or stereo)

If multichannel mode is selected and if both multichannel and stereo streams are available for the selected language and audio type, the NorDig IRD shall use the multichannel audio stream to provide downmixed audio in analog audio output(s), if applicable, and suitable digital bitstream format in digital audio output(s) as e.g. in examples in Annex G (Example table when more than one audio codec is received).

If stereo mode is selected and if both multichannel and stereo streams are available for the selected language and audio type, the NorDig IRD shall use the stereo audio source to provide audio in analog audio output(s), if applicable, and PCM stereo in digital audio output(s) as e.g. in examples in Annex G (Guidelines for NorDig IRD audio selection: “Example table when more than one audio stream is received”).

If the NorDig IRD has an optional external audio system mode, then when that external audio system mode is selected as the primary audio output, the NorDig IRD shall follow user preferences and the priorities in Table 6.1.

6.5.4 Signalling to be used for audio property

The NorDig IRD shall use the signalling information in the PMT to determine the audio property (language, audio type, audio format and stream type).

Audio Property	Supplementary audio descriptor	AAC descriptor, Enhanced AC-3 descriptor, AC-3 descriptor	ISO 639 descriptor	PMT stream type	if no signalling/descriptor
Audio Language	1 st	-	2 nd	-	-
Audio type	1 st	2 nd	3 rd		”normal”
Audio format	-	1 st	-	-	stereo
Stream type	-	2 nd	-	1 st	-

Table 6.2 NorDig IRD priority inside each audio property between different signalling for audio streams and right column the IRD’s interpretation if no signalling available for an audio stream.

See Annex I for some example cases of priority between different incoming signalling for the audio property.

Note: The behaviour of the NorDig IRD depends upon this signalling in the PMT to make the audio priority decision, so it is expected that all broadcasts will include this signalling.

6.5.4.1 Signalling to be used for audio language

For the selection of audio language (see Table 6.1 and Table 6.2), the NorDig IRD shall use the ISO 639 language code from the supplementary audio descriptor and/or the ISO 639 language descriptor.

If both descriptors are available for the same audio stream, then the supplementary audio descriptor shall have priority.

6.5.4.2 Signalling to be used for audio type

For the selection of audio type (see Table 6.1 and Table 6.2), the NorDig IRD shall use the signalling from supplementary audio descriptor (mix_type and editorial_classification), AAC descriptor (AAC_type), Enhanced AC-3_descriptor (service type flags), AC-3 descriptor (service type flags) and/or the ISO 639 language descriptor (audio_type).

If several of these descriptors are available for the same audio stream, then the supplementary audio descriptor shall have highest priority, second priority the AAC/Enhanced_AC-3/AC-3 descriptor and lowest priority the ISO 639 descriptor.

6.5.4.3 Signalling to be used for audio format

For the selection of audio format (mono, stereo or multichannel, see see Table 6.1 and Table 6.2), the NorDig IRD shall use:

- the *AAC_type* field in the AAC_descriptor for AAC audio,
- the *number of channels flags* in the AC-3 descriptor and Enhanced AC-3 descriptor for AC-3 and E-AC-3.

In any case where, for some reason, this information is not carried in the PMT for a particular audio stream, then the IRD shall prioritise based on the assumption that that audio stream contains “normal” stereo content.

6.5.4.4 Signalling to be used for audio stream type

For the selection of audio stream type (see see Table 6.1 and Table 6.2), the NorDig IRD shall use *stream_type* in the PMT and any complementing descriptor (AAC, Enhanced AC-3 or AC-3 descriptor) to decide which audio codec the stream has.

6.5.5 Examples of priority

Below are two examples aimed at explaining how the priority table shall be used. In general, the IRD’s priority decision is completed once a single stream is identified when moving down the priority table. Hence it can occur that e.g. 4th priority rules does not have to be applied because the streams to decode have already been identified.

Example 1: IRD is in stereo mode, two audio streams are available to the IRD, both have same language, normal hearing, and are stereo, stream A is coded using HE-AAC and stream B is coded using MPEG-1 Layer-II. IRD shall decode and playback MPEG-1 Layer II since, priority 1, 2 and 3 does not provide a preference between the two streams, but MPEG-1 Layer-II has higher priority than HE-AAC.

Example 2: IRD is in multi-channel mode, two audio streams are available to the IRD, both have same language, normal hearing, stream A is multi-channel coded using E-AC-3 and stream B is stereo coded using HE-AAC. IRD shall decode and playback the E-AC-3 stream since, priority 1, 2 does not provide a preference between the two streams, but the IRD is multi-channel mode and there is only one multi-channel stream; the E-AC-3 stream. In this example the stream type priority is not used since already in the audio format priority a single stream could be identified.

In case of multiple audio streams being broadcasted, a clarifying example table can be found in Annex G “Example table when more than one audio codec is received”, for how to select which audio stream to decode in multichannel or stereo user selected situation. That table is given by the property rules of Table 6.1.

6.6 Audio Output Formats

The following Table 6.3 shows the expected output format based on the currently decoded audio and per digital audio out setting (multichannel mode or stereo mode) as selected by the user.

Please note that Table 6.3 defines audio output formats after audio priority has been made between incoming audio streams (see section 6.5 and Table 6.2 for audio priority between incoming streams).

Currently Decoded Audio	Output on S/PDIF and HDMI (incl. HDMI Audio Return Channel) (see note 4)		Output on 2 ch analogue output(s) and/or built in loudspeaker(s) (see note 5)
	When Stereo mode is selected	When Multichannel mode is selected	
MPEG-1 layer II	PCM stereo	PCM stereo	Decoded MPEG-1 Layer II

HE-AAC stereo	PCM stereo	PCM stereo or optionally HE-AAC stereo on HDMI (see note 3) HE-AAC transcoded to AC-3 or DTS on S/PDIF	Decoded HE-AAC
E-AC-3 stereo	PCM stereo	E-AC-3 on HDMI (see note 2) E-AC-3 transcoded to AC-3 on S/PDIF (see note 1)	Decoded E-AC-3
AC-3 stereo	PCM stereo	AC-3 (see note 1)	Decoded AC-3
AC-3 multichannel	Downmixed PCM stereo	AC-3 (see note 1) or PCM multichannel (see note 6)	Decoded downmixed AC-3
E-AC-3 multichannel	Downmixed PCM stereo	E-AC-3 on HDMI (see note 2) E-AC-3 transcoded to AC-3 on S/PDIF (see note 1) PCM multichannel (see note 6)	Decoded downmixed E-AC-3
HE-AAC multichannel	Downmixed PCM stereo	HE-AAC multichannel on HDMI (see note 3) HE-AAC transcoded to AC-3 or DTS on S/PDIF PCM multichannel (see note 6)	Decoded downmixed HE-AAC

Table 6.3 Audio Output formats

Note 1: The S/PDIF output shall in any case comply with the content of the table above. For HDMI however, the following feature should be implemented:

When an HDMI Sink device indicates in its E-EDID structure that it only supports Basic Audio (i.e. two-channel L-PCM from the original stereo signal or from a stereo down-mix from the multi-channel signal), then the HDMI output will provide Basic Audio. This feature would then take precedence over the requirement of AC-3, E-AC-3, HE-AAC multi-channel and DTS in the table above whenever the Sink device indicates that only Basic Audio is supported. Observe however that the HDMI output could be different from S/PDIF output, since S/PDIF still has to comply with multi-channel format requirements as in the table above.

Note 2: If an HDMI sink device indicates in its E-EDID structure that AC-3 decoding is supported, but E-AC-3 decoding is not supported, the IRD shall transcode E-AC-3 streams to AC-3 prior to HDMI transmission.

Note 3: If an HDMI sink device indicates in its E-EDID structure that AC-3 or DTS is supported, but HE-AAC decoding is not supported, the IRD shall transcode HE-AAC streams to AC-3 or DTS prior to HDMI transmission.

Note 4: For IDTVs, this shall apply when External Audio System (if supported) is selected as audio output. If built-in loudspeakers are selected for audio output the minimum requirement is to have PCM output signal in the digital output.

Note 5: When external audio system (if supported) is selected as main audio output, IDTVs may optionally mute the TV speakers.

Note 6: If IRD supports PCM multichannel over HDMI (not applicable for HDMI ARC).

6.7 Audio Video Synchronisation

The NorDig IRDs shall not introduce more than ± 5 ms of relative delay between the audio and video components on the primary output (1) and not more than ± 25 ms between the primary video output and a secondary audio output. (2)

The requirement for the relative delay shall be met from 5 seconds after the start of decoding a service. The relative delay between the audio and video components shall be synchronised continuously using the service's PCR and PTS values in the MPEG transport stream, resulting in maintaining correct synchronisation until a change of service.

If the NorDig IRD, as a part of an integrated digital TV set (IDTV) has an audio output, the audio shall be in sync with the video display.

Where audio leaves the IRD in an encoded form (such as in IEC61937 [43] outputs and/or HDMI outputs and/or HDMI Audio Return Channel (ARC)), the IRD shall compensate for the decoding latency of the selected audio format, as specified for the relevant reference decoder for the selected format (e.g AC-3), such that the output of the reference decoder would be ± 5 ms with respect to the decoded video. This applies for all audio systems that the IRD supports.

Note 1: In this case, primary output for STB is primary HDMI and TV SCART, and for IDTV is the video display and internal loudspeakers (see sections 8.5 and 8.6)

Note 2: In this case, primary video output is the same as note 1. Secondary audio outputs for STB are i.e. secondary HDMI, VCR SCART, analogue RCA, and S/PDIF (see section 8.5). Secondary audio outputs for IDTV are i.e. SCART, analogue RCA, S/PDIF, HDMI ARC, headphone output, and "external audio system".

6.7.1 Adjustment of Audio/Video delay

The NorDig IRD (1) shall support the possibility to adjust the audio-delay on the HDMI and S/PDIF output (if available) at least up to 250 ms and it should be adjustable in 5 ms steps or smaller steps, as the IRD may have several different user set-ups, resulting in different a/v delays; e.g. the IRD may be connected to several types of external audio-amplifiers and the IRD may be connected to several types of external screens.

The NorDig IRD should also be able to automatically adjust the audio/video synchronization via HDMI (minimum) version 1.3 interface to compensate for delay times of video displays.

Note 1: Optional (recommended) for NorDig IDTV.

6.8 Audio Output Signals

6.8.1 Analogue Audio Output (SCART, RCA)

If the IDTV has an analogue stereo audio output on a pair of RCA connectors and/or headphone connector, the audio shall be in sync with the video display, see section 6.7.

If the NorDig IRD has analogue stereo output(s), it shall be capable of decoding and down-mixing the supported audio formats for the analogue outputs.

The NorDig IRD with SCART and/or analogue outputs shall always have an audio signal present on the analogue outputs (SCART and stereo out, see section 8.5 and to built-in loudspeakers (see note 1)) if any of the supported formats is received.

For the NorDig IRD with analogue audio outputs (SCART and/or built-in loudspeakers), it shall be possible to control the audio level on the analogue outputs primarily used for TV viewing (TV SCART and built-in loudspeakers) with the remote control unit and buttons on the front panel (if present). It should be possible to control the audio level on other analogue audio outputs (like RCA, headphone etc) using the same controls.

Note 1: For IDTVs that provide a setting to choose the audio output between the built-in TV speakers and the external audio system, it is optional to have signal in the built-in TV speakers when the external audio system setting is selected. The reasons for this are that when the user selects output to an external audio system as the priority, then the audio levels and compression settings are optimized for an external audio system and may not be suitable for output to TV speakers (e.g. lower dialogue level, high dynamic range)

6.8.2 Digital Audio Output (HDMI, HDMI ARC and S/PDIF)

When the NorDig IRD is part of an integrated digital TV set (IDTV) that can not play out a complete multi-channel audio signal, it should have an S/PDIF output and/or an HDMI Audio Return Channel (HDMI ARC) output, see sections 8.5 and 8.6.

The NorDig STB shall have an HDMI output and should have an S/PDIF output, see sections 8.6.3 (HDMI audio) and 8.5.3 (S/PDIF).

For NorDig STB, where only PCM audio will be carried on the HDMI output primarily used for TV viewing (e.g. stereo only HDMI sink (2), selection of “Stereo mode” by the user), it shall be possible to control the audio level on this HDMI with the remote control unit and buttons on the front panel (if present). Where only PCM audio will be carried on other digital audio outputs (S/PDIF, secondary HDMI port etc), it should be possible to control the audio level on other digital audio outputs using the same controls.

Where audio leaves the NorDig IRD in an encoded format, the NorDig IRD shall compensate for the decoding latency of the selected form, as specified in section 6.7.

The digital audio output as defined in section 8.5.3 (S/PDIF) and 8.6.3 (HDMI) shall always give either a valid PCM-output according to IEC 60958 [42] or a non-PCM audio bit-stream according to IEC 61937 [43]. The user shall be able to choose between the following storable output modes on the digital audio output interface (1):

1. Forced PCM output according to IEC 60958 [42] (Part1 General, Part 3 Consumer).
2. Non-PCM audio bit-stream output according to IEC 61937 [43] when present -and if not present output PCM according to IEC 60958 [42]. Non-PCM audio bitstream formats like AC-3, and DTS shall be possible to order and enable/disable according to priority set by the user.

This chapter is also valid for HDMI ARC, since this interface is specified the same as for S/PDIF interface. Observe that HDMI supports more stream types than S/PDIF.

See sections 6.3, 6.4 and 6.5 for more details.

Note 1: The IRD's different digital audio outputs may use different audio output formats, for example HDMI using PCM stereo and S/PDIF using non-PCM audio bit-stream (like AC-3 or DTS).

Note 2: A "stereo only HDMI sink" refers here to a downstream device which the STB is connected to and which can only render stereo audio, for example a TV set without a multichannel decoder.

6.9 Dynamic Changes

The NorDig IRD shall be able to handle dynamic changes of audio component(s) (PID/PIDs) in a service. The IRD shall automatically identify if an audio component is added or removed between two programme events in the same service). The NorDig IRD should gracefully handle change of service or audio format at the audio outputs without significant disturbances to the end user.

The NorDig IRD shall be able to handle the following dynamic changes without user interaction and start decoding within one second after reception of a change (like PMT update, elementary stream header signalling);

- change of number of audio channels (still same audio codec), (for example from mono to stereo to multichannel, from multichannel to stereo to mono)
- change of bitrate for an audio component (for example from 192 kbps to 160 kbps)
- change of audio PID value (typical examples are during regional news insertions) (case SVT regional news insertion), the NorDig IRD shall use next preferred audio component/PID.
- removal of one audio component/PID, the NorDig IRD shall use next preferred audio component/PID (for example; a service broadcasts two or more audio components/PIDs and then removes one of them, like removal of AC-3 during regional news broadcast). (case SVT regional news insertion)
- addition of one audio component with higher preferred user settings (for example; a service adds an audio component/PID, like add AC-3 audio component, after a regional news broadcast). (case SVT regional news insertion)

The NorDig IRD shall handle the dynamic changes after change of selected service ("zapping") or dynamic PMT update (i.e. shall not require to re-install services) and shall be able to handle the following dynamic changes without user interaction and start decoding within one second after reception of change;

- change of the audio codec, (for example change from MPEG-1 Layer II into AC-3)
- change of ISO 639-2 [70] language for an audio component.

The NorDig IRD shall be able to read the audio information contained in the DVB_SI stream_content and component_type of the component descriptor as defined in EN 300 468 [15], see also chapter 12 and section 13.3.2. The NorDig IRD should be able to present the audio information, including the descriptors for audio description for the visually impaired and audio for the hard of hearing, contained in the component descriptor to the user for information and selection purposes.

6.10 Clean Audio

The NorDig IRD should support "Clean Audio" which gives improved intelligibility by enhancing the dialogue audio of a multichannel audio service.

Today NorDig Clean Audio is limited to receiver mixing/processing of the "Normal" audio without broadcast control metadata (i.e. no AD_descriptor in the PES_private data). This is achieved by implementing an easy way to adjust the balance of the "Normal" multichannel audio between the centre channel and other channels in the audio stream before making a stereo down-mix (when used to boost the center channel compared to other channels via attenuation of the other channels). This also means that for this alternative the "Normal" audio does not include any supplementary PSI/SI signaling.

If implemented, clean audio shall be compliant to ETSI TS 101 154 Annex E4 [28], referring to the "Optional user control of mix of speech and background"

Note: NorDig will consider mandating this function when A/V decoder chipsets are available with this capability integrated within the audio decoder

6.11 Supplementary Audio

6.11.1 Informative for Supplementary Audio

A supplementary audio service (as defined in ETSI TS 101 154 [28]) is specified below for the “in-service delivery”, and applies when “normal” audio streams and the supplementary audio streams are available within the same service (i.e. listed within same PMT).

A Supplementary Audio (SA) service may be broadcasted as either:

- “Broadcast mixed” (1): pre-mixed audio by the broadcaster where the Supplementary Audio stream is a complete self-standing audio which contains both the “normal” audio mixed together with the supplementary audio content.
- “Receiver mixed”: audio containing only the supplementary audio content which is not a complete self-standing audio and is not intended to be presented on its own. The receiver mixed supplementary audio and “normal” audio is typically mixed together inside the IRD, under some control of the broadcaster (mixing level).

IRDs currently in the market are known to handle supplementary audio in a variety of ways, and there are some cases where legacy IRDs are even “disturbed” by the presence of Supplementary Audio. To mitigate this and avoid unwanted behaviour, some Networks use special signalling for the Supplementary Audio. This means for example that in some networks a broadcast pre-mixed supplementary audio may be signalled in the ISO639 descriptor as “normal” (‘undefined’) audio type but with language ‘nar’, or a receiver mix supplementary audio may be signalled in the ISO639 descriptor as ‘visual impaired’ audio type but with a different language to that of the associated “normal” audio. Modern IRDs support the Supplementary Audio Descriptor however, and hence avoid the problems associated with legacy signalling.

Note 1: Broadcast mixed refers to when the audio stream is signalled as supplementary audio via visual impaired and/or via other supplementary signalling in AC-3/E-AC-3/AAC descriptor and/or supplementary audio descriptor. This means that for the case when the audio stream is signalled with ‘nar’ language code in ISO639 descriptor and no other supplementary signalling, IRD may have different settings for, for example via primary audio language preference setting to ‘narrative’.

6.11.2 General requirements for supplementary audio

The NorDig IRD audio decoder shall be capable of supporting ‘visual impaired’ Supplementary audio (SA) services, as defined in ETS TS 101 154 [28] (however, control of pan and fade is optional).

The NorDig IRD shall (1) support both Broadcast mixed and Receiver mixed Supplementary Audio.

6.11.3 IRD settings for Supplementary Audio

6.11.3.1 IRD user preference settings for Supplementary Audio (1)

The user shall be able to enable and disable Supplementary audio and to change default, (see section 16 for IRD factory default settings).

The NorDig IRD user selection of audio preferences for ‘normal’ and ‘Supplementary’ audio (see 6.1.1) shall be a fixed setting (i.e. remain when changing service and when re-starting the IRD). (The wording for supplementary audio may typically be ‘Audio Description’, ‘AD’, referring to all versions of supplementary audio types).

6.11.3.2 Temporary selection for Supplementary Audio

The NorDig IRD should have alternative to easy but temporary select supplementary audio, e.g. via an audio key or an AD key on the remote control (i.e. a temporary selection that does not change the IRD's stored user preference settings). This temporary selection of 'Audio Type' shall not remain when changing service, language, stream type or when re-starting the IRD.

6.11.3.3 Audio priority for Supplementary Audio

Enabling a Supplementary Audio mode shall change the 'Audio Type' priority (see section 6.5). If no Supplementary audio streams are received then the NorDig IRD shall use "normal" audio from the same selected language.

If several supplementary audio streams are available for the same language and the same IRD user supplementary audio preference settings (for example both Audio description and Spoken Subtitling), then the IRD shall by default prioritise the audio that is first listed in the PMT.

6.11.3.4 Display of available Supplementary audio streams

The IRD should present information to the user if the service has a supplementary audio available, for example in "info banner" after selecting such a service.

If the IRD offers the option to select a supplementary audio track as a temporary selection, then the IRD should indicate that this is of a supplementary audio type together with its language.

6.11.3.5 Audio mixing level

The NorDig IRD shall be able to adjust the relative audio mixing level between the incoming receiver mixed supplementary audio and the "normal" audio.

This relative adjustment of audio mixing level should be able to both enhance and reduce the supplementary audio level compared to the "normal" audio before mixing depending on user settings.

6.11.4 Selection of audio streams

The NorDig IRD shall be able to select the correct audio type stream according to user preference settings, see section 6.5.

The NorDig IRD shall support to by default select the "normal" audio stream for services which has several audio streams with different audio type for selected language.

When the user has selected Supplementary Audio as preferred audio, the NorDig IRD shall support to by default select the supplementary audio stream for services which have several audio streams with different audio type for selected language.

Observe that the Supplementary Audio descriptor overrides the language and audio type stated in the ISO639 descriptor, see section 6.5.4.

6.11.5 Signalling for Supplementary Audio

All Supplementary Audio streams (both Broadcast mixed and Receiver mixed) will be signalled by the broadcaster by means of the Supplementary Audio descriptors and for services with several audio streams (e.g one "normal"/ plus one Supplementary Audio stream) also an ISO 639 language descriptor.

Broadcast mixed Supplementary Audio streams will in ISO 639 descriptor use audio type 0x00 'undefined' (to avoid issues in legacy IRDs).

Receiver mixed Supplementary Audio streams will in ISO 639 descriptor use audio type 0x03 'visual impaired' or 0x00 'undefined' (to avoid issues in legacy IRDs).

See section 6.5.1 for priority between different descriptors for audio streams and section 12.6 for more information about the descriptors for audio.

6.11.6 Receiver mixing

The NorDig IRD shall support Receiver mixed Supplementary Audio when the two audio streams are of the same codec family, sampling rate and on two different PIDs. The NorDig IRD shall support receiver mixing of Supplementary Audio services encoded as MPEG-1 Layer II, HE-AAC and E-AC-3 coding standards, where those codecs are supported.

The NorDig IRD is not required to support receiver mixing when “normal” and Supplementary Audio are broadcasting within the same E-AC-3 stream/PID.

The NorDig IRD shall be able to mix the “normal” audio stream together with the supplementary audio stream (‘visual impaired’).

The NorDig IRD shall not decode a ‘receiver mixed’ supplementary audio stream without also decoding and presenting it with the associated “normal” audio stream either mixed to the same audio output, or optionally presenting Supplementary Audio on its own on the headphones output while presenting the “normal” audio on the other audio outputs, see section 6.10.7.

6.11.6.1 Receiver mixed, Pan and fade control

For MPEG-1 Layer II and HE-AAC, the NorDig IRD should support pan and fade control of the receiver mixing via inband control metadata in audio stream as described in ETSI TS 101 154 Annex E [29] and for E-AC-3 as in TS 102 366 [36].

For MPEG-1 Layer II and HE-AAC, the supplementary audio stream may carry the AD descriptor in its PES_private_data, as defined in TS 101 154 Annex E.2. This AD descriptor provides the audio decoder with the information needed to control the mixing the supplementary stream with the main stream (pan and fade). For MPEG supplementary audio stream without AD descriptor in PES header, the NorDig IRD shall use mixing as central forward presentation (pan 0x00) and no fade (fade = 0x00).

For the E-AC-3 codec, the mixing data is carried in the supplementary E-AC-3 stream, as defined in TS 102 366 [35], and, for this codec, any AD descriptor shall be ignored.

6.11.7 Receiver mixed on its own on for head-phones output

The IRD with head-phones output should also support presenting the receiver mixed Supplementary Audio on its own on the head-phones interface and at the same time presenting the “normal” audio on its own on the other main audio outputs (HDMI, S/PDIF etc).

The reason behind this alternative is that:

- other family members may not want to be disturbed by the Supplementary Audio, but still be able to watch a programme together with family members who are helped by the Supplementary Audio and/or
- use of a separate loudspeaker for the Supplementary Audio compared to the “normal” audio, which can help to localise the different audio types and thereby give better intelligibility.

6.11.8 Broadcast mixed

The NorDig IRD shall support broadcast mixed supplementary audio services encoded as MPEG-1 Layer II, HE-AAC, AC-3 and E-AC-3 coding standards, where those codecs are supported.

6.12 IRD Internal Reference Level

The level for reference tones for transmission will be 18 dB below clipping level, in accordance with EBU Recommendation R.68 “Alignment level in digital audio production equipment and in digital recorders” as recommended by ETSI TS 101 154 [23].

6.13 Loudness Levels, – Dynamic Range Control and Downmixing

To achieve loudness and dynamic range consistency over codec formats, the Nordig IRD shall follow the following guidelines on audio levelling and dynamic range control. A typical implementation for loudness levels on an IDTV-implementation is found in Annex H, “Loudness levels, – Typical IDTV Audio Block diagram”.

6.13.1 HE-AAC Audio Input and AC-3/E-AC-3 Audio Input

The Nordig IRD shall, by default, be able to present the decoded HE-AAC /AC-3/ E-AC-3 bitstream at an average loudness level of -23 LUFS. Where `prog_ref_level` as of ISO/IEC 14496-3 [55] or `dialnorm` as of ETSI TS 102 366 [35] is included in the stream, it shall indicate the loudness of the audio essence contained within the bitstream using the numerically equivalent dBFS value (e.g. a measured loudness of -23 LUFS shall be indicated by a `prog_ref_level` / `dialnorm` value of -23 dBFS).

6.13.1.1 HE-AAC Decoding

For decoding to a Target Reference Level of -23 dBFS, the following applies:

If program level data of the form `prog_ref_level` as of ISO/IEC 14496-3 [55] is present in the bitstream, it shall be used; otherwise a `prog_ref_level` of -23 dBFS shall be used.

If `drc_presentation_mode` as of ETSI TS 101 154 Annex C.5.2.2.3 [29] is present in the bitstream and indicates DRC Presentation Mode 2, then any dynamic range control data of the form `dyn_rng_sgn/dyn_rng_ctl` as of ISO/IEC 14496-3 [57] also present in the bitstream shall (1) be used and may not be scaled if they indicate negative gains. Otherwise if dynamic range data of the form `compression_value` as of ETSI TS 101 154 Annex C 5.2 [28] or of the form `compression_value` as of ISO/IEC 14496-3 [55] is present in the bitstream, it shall be used and it may be scaled.

It is expected that the broadcaster shall ensure that sufficient headroom and/or dynamic range control values are included in the transmission to prevent any overload when downmixing.

For NorDig IRDs that supports a multichannel audio output, the Nordig IRD should be able to decode utilizing a Target Reference Level of -31 dBFS. See section 6.13.3 for audio output levels.

For decoding to a Target Reference Level of -31 dBFS, the following applies:

If program level data of the form `prog_ref_level` as of ISO/IEC 14496-3 [55] is present in the bitstream, it shall be used; otherwise a `prog_ref_level` of -23 dBFS shall be used.

If dynamic range control data of the form `dyn_rng_sgn/dyn_rng_ctl` as of ISO/IEC 14496-3 [55] is present in the bitstream, it shall be used and it may be scaled.

If downmixing is performed and dynamic range data of the form `dyn_rng_sgn/dyn_rng_ctl` as of ISO/IEC 14496-3 [55] is present in the bitstream, those shall be applied without scaling if they indicate negative gains.

Note 1: Optional for the NorDig IRDs released before 1 July 2015.

6.13.1.2 E-AC-3 and AC-3 Decoding

For decoding to a Target Reference Level of -23 dBFS, the following applies:

If program level data of the form `dialnorm` as of ETSI 102 366 [35] is present in the bitstream, it shall be used, if dynamic range control data of the form `compr` as of ETSI 102 366 [35] is present in the bitstream, it shall be used and it may not be scaled.

It is expected that the broadcaster shall ensure that sufficient headroom and/or dynamic range control values are included in the transmission to prevent any overload when downmixing. For NorDig IRDs that supports a multichannel audio output, the Nordig IRD should be able to decode utilizing a Target Reference Level of -31 dBFS. See section 6.13.3 for audio output levels.

For decoding to a Target Reference Level of -31 dBFS, the following applies:

Program level data of the form dialnorm as of ETSI 102 366 [35] shall be used.

If dynamic range control data of the form dynrng as of of ETSI 102 366 [35] is present in the bitstream, it shall be used and it may be scaled.

If downmixing is performed and dynamic range data of the form dyn_rng_sgn/dyn_rng_ctl as of ISO/IEC 14496-3 [55] or of the form dynrng as of of ETSI 102 366 [35] is present in the bitstream, those shall be applied without scaling if they indicate negative gains.

6.13.1.3 Summary

A summary of which levelling data and dynamic range control parameters shall be used in conjunction with which stream type target reference level and DRC presentation mode can be found in Table 6.4 below.

Stream type	Target reference level	Levelling data	DRC Presentation Mode	Dynamic range control parameter
(E)-AC-3	-23 dBFS	dialnorm per ETSI TS 102 366	n/a	compr per ETSI TS 102 366
(E)-AC-3	-31 dBFS	dialnorm per ETSI TS 102 366	n/a	dynrng per ETSI TS 102 366
HE-AAC	-23 dBFS	prog_ref_level per ISO/IEC 14496-3	Mode 1	compression_value per ETSI 101 154 Annex C
HE-AAC	-31 dBFS	prog_ref_level per ISO/IEC 14496-3	Mode 1	dyn_rng_sgn/dyn_rng_ctl per ISO/IEC 14496-3
HE-AAC	-23 dBFS	prog_ref_level per ISO/IEC 14496-3	Mode 2	dyn_rng_sgn/dyn_rng_ctl per ISO/IEC 14496-3
HE-AAC	-31 dBFS	prog_ref_level per ISO/IEC 14496-3	Mode 2	dyn_rng_sgn/dyn_rng_ctl per ISO/IEC 14496-3

Table 6.4 Target reference levels

6.13.2 MPEG-1 Layer II Audio Input

For MPEG-1 Layer II audio input, the default loudness is assumed to be -23 LUFS and therefore no level adjustments are expected to be made for decoding to a target reference level of -23 dBFS. It is expected that the broadcaster ensures that MPEG-1 Layer II audio stream has an equivalent loudness level of -23 LUFS.

For decoding to a Target Reference Level of -31 dBFS (i.e. digital audio output), the following applies:

An attenuation of 8 dB shall be made to the audio stream.

6.13.3 Audio Output Levels

In order to match the loudness of PCM and coded audio streams in a downstream AV receiver, PCM streams at a target reference level of -23 dBFS shall (1) be reduced in level by 8dB before being output on S/PDIF or HDMI to that device. PCM streams at a target reference level of -31 dBFS shall not be

increased in level prior to output. When an HDMI Sink device indicates in its E-EDID structure that it supports multichannel audio, then the output should be at a target reference level of -31 dBFS.

When an HDMI Sink device indicates in its E-EDID structure that it only supports Basic Audio (i.e. two-channel L-PCM), then the output should be leveled to a target reference level of -23 dBFS.

For analog (stereo) outputs, the target reference level should be leveled to -23 dBFS (as measured on a digital signal).

Note 1: Optional for the NorDig IRDs released before 1 July 2015.

7 Teletext and Subtitling

7.1 General

DVB Subtitling and EBU Teletext Subtitling are mandatory in the NorDig IRDs. The user shall be able to enable and disable displaying of subtitles and to select primary and secondary subtitling language, see sections 7.2 and 7.3.

Note: The NorDig Hybrid shall support Subtitling preferences and requirements as stated below also for broadband distributed content where applicable.

7.1.1 Subtitling user preferences

The IRD shall have user selection of subtitling preferences for 'normal' or 'hard of hearing' subtitles. The user preference settings for subtitling should be common for EBU Teletext subtitling and DVB Subtitling, see section 16 for factory default settings of the subtitling.

Note: Correct functionality for the Hard of Hearing/hearing impaired service, requires that the Content Providers delivers this service as a mix of translated subtitling and Hard of Hearing/hearing impaired subtitling.

7.1.2 Only display subtitling if match language in user preferences

The NorDig IRD shall (1) only display subtitles, if a language of the received subtitle matches any of the NorDig IRD's user preference settings for language for subtitling. (This means that if none of languages for the received subtitle(s) match any of the IRD's user preference settings language for subtitling, then the NorDig IRD shall not display any subtitles).

Note 1: Optional for NorDig IRD released before 1 July 2015.

7.1.3 Temporary changes to subtitling settings

In case of the user has made temporary changes of the subtitling settings (i.e. without changing the IRD's user preference setting), then this change shall (1) (at least) remain until the user change service. (Clarification, this means the IRD shall not change back temporary subtitling setting based on EIT events for the service).

Note 1: Optional for NorDig IRD released before 1 July 2015.

7.1.4 Subtitling mode (Normal and Hard of hearing subtitling)

In case of 'normal' subtitling mode is selected, then the NorDig IRD shall (1) only display 'normal' subtitles (signalled in subtitling descriptor and/or teletext descriptor). In this 'normal' subtitling mode the NorDig IRD shall not display any (hard or hearing) subtitling if the subtitling stream only includes 'hard of hearing'/'hearing impaired' pages.

In case of 'hard of hearing' subtitling mode is selected and if no 'hard of hearing'/'hearing impaired' pages are received (signalled in subtitling descriptor and/or teletext descriptor), then the NorDig IRD shall as a default use 'normal' subtitling pages from the same selected language. (For Teletext, see section 7.2).

Note 1: Optional for NorDig IRD released before 1 July 2015.

7.1.5 Simultaneous EBU and DVB subtitling

If both DVB Subtitling and EBU Teletext subtitling are received simultaneously with the same language code, the IRD shall only display the DVB Subtitling stream.

7.1.6 Simultaneous EBU Teletext and HbbTV Digital Teletext

For services that have both an EBU Teletext service and an HbbTV Digital Teletext application signalled and available, the NorDig Hybrid shall (1) be able to start and display the HbbTV Digital Teletext application as well as being able to start and display the EBU Teletext service (one at a time).

The NorDig Hybrid shall (1) start teletext and be able to toggle between any HbbTV Digital Teletext and any EBU Teletext service as described in clause 5.3.4 of HbbTV specification ETSI TS 102 796 [30].

Note 1: Optional for NorDig IRD released before 1 July 2015.

Note: An EBU Teletext service refers here to classical Enhanced Teletext specification EN 300 472 [16], while a Digital Teletext Service refers here to an HbbTV application which is identified with an `application_usage_descriptor` in the AIT with `usage_type` equal to 1 as defined in the HbbTV specification ETSI TS 102 796 [30]; and typically launched by the TEXT key on Remote Control. The HbbTV based Digital Teletext could typically be a more modern version and replacing the EBU Teletext for Hybrid IRDs.

7.1.7 Simultaneous Subtitling and HbbTV

A NorDig Hybrid shall support simultaneous display of HbbTV application and subtitles (DVB subtitling and EBU teletext subtitling), both for broadcast and at least for MPEG2 TS delivered via broadband [29].

The NorDig Hybrid shall display the HbbTV application over the subtitles as described in clause 10.1.1 of HbbTV specification ETSI TS 102 796 [30]. This means that if the video is up or down-converted, to other than full screen video, the subtitles shall either be rescaled/repositioned appropriately or not displayed at all.

Note: The requirement for simultaneous display of HbbTV application and subtitles is optional (should) within HbbTV ETSI TS 102 796, while within NorDig Hybrid (HbbTV) IRDs this is mandatory (shall) to support.

7.2 EBU Teletext

7.2.1 General

During normal operation, the NorDig IRD shall be able to demultiplex in parallel the EBU Teletext service transmitted in a packetised format according EN 300 472 [16].

The NorDig IRD shall include a teletext decoder to be able to display EBU Teletext using the OSD. The NorDig IRD shall be able to display EBU Teletext subtitling, both 'normal' Teletext subtitling pages of type 0x02 and Teletext subtitling pages for hearing impaired people of type 0x05, meeting the requirements for level 1.5 in ETSI EN 300 706 [18], "Enhanced Teletext Specification"

The Nordic characters defined in the Latin G2 supplementary set shall be supported

The NorDig IRD with OSD presentation shall be able to cache at least 200 decoded EBU Teletext pages in order to improve the access time for frequently used pages.

7.2.2 Additional requirements for Analogue video Interface

The NorDig IRD shall for the analogue outputs also support insertion of the EBU Teletext data in the VBI of the analogue CVBS video output. In this case the teletext decoder of the TV-set might be used instead of the one in the STB. The VBI insertion shall be compliant with ITU-R BT.653-3 [62]. The EBU Teletext data shall be inserted in the lines 6 to 22 and lines 320 to 335.

7.3 DVB Subtitling

7.3.1 General

The NorDig IRD shall be capable of decoding, as a minimum, a subset of the DVB subtitle services as specified in section 7.3.2 and transmitted in conformance with ETS 300 743 [19], and displayed using the OSD capabilities whilst decoding the full television service (video and audio) to which it is associated.

The NorDig IRD shall be able to display both 'normal' and 'hard of hearing' subtitles, according to user preference settings.

Within DVB Subtitling it is possible to transmit common pages for all languages and subtitling streams inside one DVB subtitling PID, this is referred to as 'ancillary pages'. Support for ancillary pages is

optional for NorDig IRD. The enabling or disabling of the subtitle ancillary pages, if available, should be user controlled, with subtitle ancillary pages enabled as default option. The selection of subtitle ancillary pages shall be independent of the enabling of subtitle composition pages.

The precision of the presentation of the subtitles shall be within 2 frames.

7.3.2 Subtitling subset

The NorDig IRD shall at least be capable of decoding the following DVB subtitling services:

DDS	The Display Definition Segment for a subtitle service shall be supported for services that implement DDS, as defined in EN 300 743 [19]. Absence of a DDS implies that the display segment width shall be assumed as 720 pixels and the height as 576 lines.
Object types:	The handling of the object type (0x00) 'basic object, bitmap' shall be supported. The handling of the other object types (i.e. 0x01), 'basic object, character' and (0x02) 'composite object, string of characters') is optional.
Regions:	The number of regions shall be according to the ETS 300 743 [19] specification, however a limitation in the display area due to memory restrictions is allowed. The total number of regions to handle shall be able to cover four complete subtitle rows (per frame) where: One subtitle row shall be extendable to 1906 pixels * 60 pixels. The regions shall have the possibility to cover 457440 pixels per frame.
Number of objects:	The number of objects shall be at least 128.
CLUT:	The NorDig IRD shall be able to handle at least one colour look-up table (CLUT) with a minimum of 16 entries per region and the possibility to have one colour scheme applied in each of the regions. It shall be possible to choose any 24-bit RGB colour into the 16 entries. The decoder shall be able to handle the mapping to the closest colour match if the decoder has some limitation in the colour presentation. The use of the non_modifying_colour flag is optional.
Transparency:	The NorDig IRD shall implement at least 5 levels of transparency; 0% (opaque), 30%, 50%, 70% and 100% (completely transparent). Implementation of additional intermediate levels of transparency is optional. Where the NorDig IRD cannot complement a particular value of semi-transparency it shall replace it with the nearest value of transparency it can implement. However, if the encoded value of transparency is in the range 10%-90% it shall not be approximated as either 0% or 100% transparency. So, 9% may be approximated as 0% but 10% shall be represented with a value in the range 10% to 90%, such as 30%. Similarly, 91% may be approximated as 100%.
Number of streams:	The NorDig IRD shall support at least one DVB-subtitling streams i.e. at least support decoding of one subtitling composition page while support of one simultaneously available ancillary page is optional.

8 Interfaces and Signal Levels

8.1 Introduction

This chapter includes requirements to the various external interfaces, except for the frontends (tuner/demodulators) that are treated in chapter 3.

The main functional blocks are described in chapter 2 for the case with embedded tuner/demodulator.

8.2 RF- bypass (option)

NorDig IRD should have an RF-bypass ($RF_{in} - RF_{out}$), see sections 3.3.3 and 3.4.7.

8.3 Two-way Interface

The NorDig IRD with the Hybrid profile or an IP-based front-end shall support at least one of the following interaction channel interfaces:

1. Ethernet (IEEE 802.3 [45] (100 Base-T, Auto-sense).
2. EuroDocsis in accordance with ITU-J.122 [59] (ref IRDs with a cable front-end).
3. Wireless LAN, Ethernet 802.11 n (1) [44]
4. Power line [HomePlug AV Specification, IEEE 1901.2010]
5. USB 2.0 or higher

Note 1: Support of Ethernet 802.11 b, g or n for IRDs that are launched before July 2011

8.4 SCART Interfaces (Option)

The NorDig STB should have one SCART Interface in accordance with EN 50049-1 [6] and EN 50157-2-1 [8].

The following table summarises the input/output signals available at all SCART interfaces:

SCART	requirement	CVBS/AUDIO	RGB	PIN 8	PIN 16
1 TV	Mandatory*	Out	Out	out (1)	out (2)
2 VCR	Optional	in and out (3)	In	In	In (4)

Table 8.1 SCART requirements

* Not relevant for iDTV

- (1): the voltage shall be forwarded from in to out (12V or 6V)
- (2): the voltage shall be forwarded from in to out (0V or 1 - 3V)
- (3): the OSD graphics should not be present on the VCR scart output except for DVB subtitling (if present and chosen)
- (4): the voltage should be forwarded from in to out (0V or 1 - 3V)

Control signal definitions:

PIN 8: nom. 0 Volt/DC: internal source of the TV set
 nom. 6 Volt: external source, 16:9 format
 nom. 12 Volt: external source, 4:3 format

PIN 16: nom.0 Volt/DC: CVBS active
 1-3 Volt/DC: RGB active

8.5 Audio Output Interfaces (Option)

8.5.1 VCR SCART connector for analogue audio

The audio interface of the VCR SCART shall deliver the same audio signal as available at TV SCART Interface. The internal volume control should only affect the audio signal at TV SCART interface, but not the audio signal of the VCR SCART audio interface.

8.5.2 RCA connector for analogue audio

The NorDig IRD analogue audio interface based on RCA connectors shall be:

- Two RCA connectors, female type IEC 60603-14 [41].

The audio signals shall be as specified in section 6.5 (Audio Prioritising).

8.5.3 S/PDIF connector for digital audio

The NorDig IRD should include digital audio interface, based on S/PDIF, (IEC 60958 [42]) and a non-PCM encoded audio bit stream according to IEC 61937 [43], with a coaxial and/or an optical connector.

The audio signals shall be as specified in section 6.5 (Audio Prioritising).

8.5.4 Headphone connector for analogue audio

The NorDig IRD should include analogue audio interface based on headphone connectors with 3.5 mm TRS stereo mini tele jack or ¼” TRS stereo tele jack.

8.6 HDMI Interface

8.6.1 General

The NorDig iDTV with screen diagonal 30 cm and above shall have a HDMI input interface in accordance with the DigitalEurope HD-Ready requirements [6] and the High Definition Multimedia Interface [40]. HDMI input interface is highly recommended for iDTV-sets with smaller screen diagonal. The HDMI output interface is recommended for iDTV-sets.

The NorDig STBs shall have at least one High-Definition Multimedia Interface (HDMI) with type A output connector [38], supporting displays that comply with the DigitalEurope HD-Ready requirements [5] and the High Definition Multimedia Interface [40].

8.6.2 Video Output and Display

The NorDig STB shall recognise E-EDID information provided by the display and subsequently follow the below requirements.

The NorDig STB **shall** use 1920x1080p@50 Hz as the default output format, if supported by the display.

If 1920x1080p@50 Hz is not supported by the display, the NorDig STB **should** use 1280x720p@50Hz, rather than 1920x1080i@25Hz, as the output format – although this priority requirement may not comply with the specified priority order in the HDMI specifications regarding E-EDID information exchange.

The user **shall** be able to override the above behaviour in two different ways:

1. By choosing an “Original Format” option, i.e. to output the same format as received, if supported by the display. If the received format is not supported, the STB **shall** select the display mode providing the best possible video quality, as indicated by the E-EDID information. This is to avoid the STB output to go black, if there is a mismatch between received format and display capability.

Note: In the case of received 1080p@25Hz, and the display does not accept this, the STB should perform 2:2 pulldown (a.k.a. frame-doubling) to reach 50 Hz and subsequently retry with the E-EDID information exchange.
--

2. By choosing a “Fixed Format” option, i.e. to manually set, preferably with a dedicated knob on the remote control, the default output format from the NorDig STB to a fixed video format. The video format options **shall** include 1920x1080p@50Hz, 1280x720p@50Hz and 1920x1080i@25Hz.

8.6.3 Audio Output

The HDMI Audio Output is specified in section 6.6 (Audio Output Formats). For IRDs integrated in IDTVs, a HDMI Audio Return Channel (HDMI ARC) should be implemented.

8.6.4 Signal protection

HDMI interfaces that can output content that is originated from a DVB input signal shall support the High-bandwidth Digital Content Protection (HDCP) [37].

The received service may be flagged with a need for content protection or not (CP “ON” or “OFF”) via either the PMT-table or the CA-system or both, as specified by the relevant network/CA-operator. Signals that the IRD is entitled to receive shall be sent to the HDMI-sink (display) in accordance with the following conditions:

- A. In case the received service is flagged with no need for content protection, the signal may be sent to the sink with HDCP disabled (1).
In case both the PMT-table and the CA-system are used for signalling of such flag, and the HDCP is set to ”OFF”, the signal shall only be sent to the sink when both the flag received via the PMT-table and the flag received via the CA-system indicate no need for content protection.
Note 1: Disabling of HDCP is optional
- B. In case the received service is flagged with content protection required via either the PMT-table or the CA-system, the signal shall only be sent to the sink with the HDCP enabled, i.e. when the HDMI sink satisfies the HDCP requirements and HDCP protection is established on the HDMI-link.

The IRD should (1) provide an option for setting the preferred HDCP-state, (“HDCP-user setting”) to either ON or OFF. The HDCP-user setting shall apply to all services receivable by the IRD. Changes to this setting shall survive channel change, stand-by and power on/off.

Note 1: This option – when available- shall be available via the IRD’s menu system, unless otherwise specified by the relevant network/CA-operator.

Table 8.2 defines the required actions of the IRD, based on the required content protection for the received service and the selected HDCP-user setting. The required content protection level and the required HDCP-state may be flagged via the PMT-table (see section 0) and/or the CA-system (as specified by the relevant network/CA-operator).

Content Protection level flagged via			HDCP-user setting		Description (IRD actions)
Mode	CA-system (1)	PMT-table (2)	"ON"	"OFF" (3)	
1	HDCP Not wanted	0x00 (HDCP Not wanted)	DISABLE HDCP	OK (5)	HDCP shall be disabled for this service regardless of HDCP user setting (Return to HDCP-user setting when leaving this service)
2	HDCP Wanted	0x00 (See above)	OK (4)	ENABLE HDCP	HDCP shall be set to ON for viewing this service (Return to HDCP-user setting when leaving this service)
3	CP Not needed	0x01* Not needed *) <i>Default value if no signalling</i>	OK (4)	OK(5)	Content protection is not required. HDCP may be set to ON or OFF
4	CP Required	0x01 (See above)	OK (4)	Display message (6)	Content protection is required. HDCP ON is required for viewing this service
5	CP Not needed	0x02 (cond' al requirement)	OK (4)	OK(5) if SD content Display message (6) if protected content is received	HDCP may be set to ON or OFF for SD (see table 12.20) HDCP ON is required for HD for viewing this service
6	CP Required	0x02 (See above)	OK (4)	Display message (6)	Content protection is required. HDCP ON is required for viewing this service
7	CP Not needed	0x03 (CP required)	OK (4)	Display message (6)	Content protection is required. HDCP ON is required for viewing this service
8	CP Required	0x03 (See above)	OK (4)	Display message (6)	Content protection is required. HDCP ON is required for viewing this service

Note 1: The specified modes may be omitted or redefined by the relevant network/CA-operator. Modes 2, 4, 6 and 8 are not relevant when the CA-system is not used for signalling of required content protection level.

Note 2: The Content protection levels are fully defined in Table 12.28.

Note 3: "HDCP OFF" is not recommended for the HDCP user setting in networks where some programmes will require "HDCP ON", because it may lead to excessive zapping times.

Note 4: No change needed (HDCP is ON)

Note 5: No change needed (HDCP is OFF)

Note 6: The IRD shall inform the end user that the HDCP user setting must be turned ON in order to view protected content.

Table 8.2 IRD actions versus required (signalled) Content Protection level and HDCP user setting

8.6.5 Additional analogue interfaces for NorDig IRD signals (option)

The NorDig STB shall provide down-converted versions of the received HDTV signals via analogue video interfaces, where the output signal is down-converted to SDTV format, see section 5.11.

The NorDig IRD may provide analogue audio output signals via the SCART and/or the RCA connectors, as specified in sections 8.4, 8.5.1 and 8.5.2.

8.7 Remote Control Interface

8.7.1 General

The NorDig IRD shall have remote control functions as specified in section 8.7.2 below.

8.7.2 Functions

The remote control for the NorDig IRD shall include the following functions (the labelling names that are used in Figure 8.1 are shown below within square brackets for each function), associated with input events. An input event may be associated with a physical key or a logical (e.g. on-screen) key, where the “logical key” is associated with the same function as specified for the corresponding physical key.

8.7.2.1 Numeric Entry

The NorDig IRD’s remote control shall include 10 digit keys, labelled 0-9.

8.7.2.2 Basic TV Functions

The NorDig IRD’s remote control should include the following keys for basic TV functionality. If present, they shall have the following functionality:

- Power on/off [on/off] – turns the IRD on and off
- Programme up/down [P+, P-] – function to switch between programmes
- Volume up/down [V+, V-] – function to adjust the volume output level
- TV/ Radio [TV/radio] – function that puts the IRD directly into conventional television state, i.e. only audio, video and subtitling or radio state (i.e. toggle between TV and Radio category list of services)..
- Subtitle/ option [subt/option] – This function displays the subtitle as defined in section 7 and could also be used to temporary select other user selectable options (e.g. change subtitling language if several available, audio language/track if several available, video aspect ratio output format etc)..
- Info [Info] – This function displays additional information if available.

8.7.2.3 Digital TV Functions

The NorDig IRD’s remote control shall include the following keys for digital TV functions:

- [←, ↑, →, ↓] – A navigation or pointing system for navigation on the OSD
- OK [OK] – a function that selects or confirms current choice or statement
- Multifunctional keys [●, ●, ●, ●] – four colour-coded keys for non-dedicated functions. The colours shall be red, green, yellow and blue
- Text [Text] – This function launches the HbbTV Digital Teletext application and/or the EBU Teletext as defined in section 7.1 if present.

The NorDig Hybrid IRD’s remote control shall in addition also include the following keys for digital TV functions:

- Exit [Exit] – This function terminates the currently running HbbTV application. It does not disable the HbbTV feature, therefore if the current service has an autostart application then it shall be re-launched and broadcast video shall be reset to its default position.

In addition the NorDig IRD remote control should include the following keys for digital TV functions:

- Menu/Navigator [Menu] – this function starts the “Navigator”, as specified in chapter 13.
- Guide/EPG [Guide] – this function displays an Electronic Programme Guide.
- Back [Back] – This function exits from the current menu or “page” and returns to the previous state.

8.7.2.4 PVR Functions (only for NorDig PVR)

The NorDig PVR IRD functions specified in chapter 14 shall be available via the remote control, using dedicated PVR keys or multifunctional keys or a combination of these. The Manufacturer shall state in the manual how to operate the NorDig PVR IRD's PVR features via the Remote Control.

The NorDig PVR IRD's remote control shall include the following keys for PVR functionality:

- List of recordings [PVR List] – opens a screen with list of recordings (can be both history and booked).
- OTR [OTR] – One-Touch-Recording
- Record [Rec] – Start manual recording / start recording of present event.
- Timeshift [t.shift] – "pause" live TV (timeshift)
- Pause [Pause] – pause Playback of recording.
- Play [Play] – start playing timeshift TV / start playback of recording.
- Stop [Stop] – stop recording / stop timeshift / stop playback.
- Fast Forward [F.fwd] – fast forward of the timeshift or recording (with different speeds).
- Fast Rewind [F.rwd] – fast rewind of the timeshift or recording (with different speeds).

Note: Some keys may be multifunctional, including several IRD features using the same key. For example in a PVR the Timeshift and Pause functions or OTR and Record functions may be achieved using the same key.

The NorDig PVR should have the following additional functions available via the remote control. If present, they shall perform the stated function:

- Slow Forward [S.fwd] – slow forward of the timeshift or recording (with different speeds).
- Slow rewind [S.rwd] – slow rewind of the timeshift or recording (with different speeds).
- Jump [Jump] – go to a specific time in the recording / fast jump to a manufacture defined fixed time or to next index point.
 - Index [Index] – insert index point into recording

8.7.2.5 Design and Labelling

The manufacturer is free to modify the design of the remote control and the labelling of the Basic TV, "Menu/Navigator", "Guide/EPG", "Back" and PVR -functions. All other functions should be labelled as in the conceptual illustration of the NorDig IRD remote control in Figure 8.1.

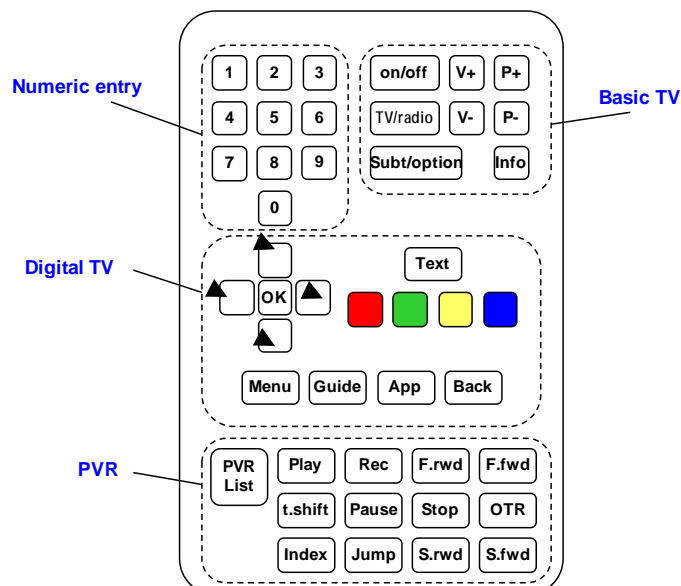

Figure 8.1 Conceptual illustration of the NorDig IRD remote control

8.7.2.6 Mapping of Key Events for NorDig Hybrid profile

The NorDig Hybrid IRD shall generate (HbbTV) events according to Table 8.3 when a key is pressed on the NorDig IRD remote control.

Key	KeyEvent
0-9	VK_0 to VK_9
UP	VK_UP
DOWN	VK_DOWN
LEFT	VK_LEFT
RIGHT	VK_RIGHT
OK	VK_ENTER
BACK	VK_BACK
RED	VK_RED
GREEN	VK_GREEN
YELLOW	VK_YELLOW
BLUE	VK_BLUE
STOP	VK_STOP
PLAY	VK_PLAY or VK_PLAY_PAUSE ⁽¹⁾
PLAY	VK_PLAY_PAUSE
PAUSE	VK_PAUSE or VK_PLAY_PAUSE ⁽¹⁾
PAUSE	VK_PLAY_PAUSE
FAST FORWARD	VK_FAST_FWD and
FAST REWIND	VK_REWIND

Table 8.3 Mapping of NorDig Hybrid IRD Key Events to HbbTV.

Note 1: VK_PLAY and VK_PAUSE are used for PVRs with separate remote control keys for these two functions, while VK_PLAY_PAUSE is used for PVRs with one common toggling multifunctional key for these two functions.

Note: Below keys are not available to HbbTV applications.

ON/OFF	Not available to HbbTV applications
P+	Not available to HbbTV applications
P-	Not available to HbbTV applications
V+	Not available to HbbTV applications
V-	Not available to HbbTV applications
TEXT	Not available to HbbTV applications
SUBTITLE/OPTION	Not available to HbbTV applications
GUIDE	Not available to HbbTV applications
INFO	Not available to HbbTV applications
TV/RADIO	Not available to HbbTV applications

9 Interfaces for Conditional Access

9.1 General

The NorDig IRD shall (1) support at least one Common Interface Plus (for CA module) for conditional access and/or it shall support at least one smart card interface (2) for conditional access. The smart card interface with associated embedded functions should support use of external smart card(s) for at least one CA-system.

All NorDig iDTV sets with screen diagonal larger than 30 cm shall be equipped with at least one Common Interface that comply with the Common Interface Plus specification, see section 9.2. The Common Interface is optional/recommended for other NorDig IRD types (e.g. STB).

Note 1: Mandatory for the NorDig IRDs that are intended for use in networks broadcasting signals that are accessed controlled, as well as not access controlled.

Note 2: The requirements for conditional access interfaces are specified by the relevant network/CA operator.

9.2 Use of the Common Interface

9.2.1 General

The Common Interface can be used for conditional access and other purposes. A Conditional Access (CA) Module (CAM) may be connected to the Common Interface of the NorDig IRD in order to provide access control of the incoming services.

The Common Interface shall be able to be used with modules that comply with the DVB Common Interface Plus specification (version 1.3 or later), see ref. CI Plus specification [66]; such modules are referred to as CIP-CAM.

The Common Interface shall also be able to be used with CA-modules that comply with the DVB Common Interface specification, see EN 50221 [9]; such modules are referred to as CI-CAM.

9.2.2 Minimum requirements for the Common Interface

Each CI-slot of the NorDig IRD shall (1) be in compliance with the Common Interface Plus (CIP) specification [66]. Each CI-slot shall support both CIP-CAMs and CI-CAMs in accordance with with the interoperability matrix that is specified in the CI Plus specification [66], table 4.1.

Note 1: As stated in section 9.1 CI is mandatory for NorDig iDTV-sets (with screen diagonal above 30 cm) (and is optional for other NorDig IRD types).

The CI Plus interface for the NorDig IRD shall support at least the maximum bitstream that can be provided via the front-end, see section 4.1 (1). The CIP-CAM shall support 96Mbit/s.

Note 1: The CI Plus specification [66] states that the IRD shall support 72Mbit/s and may support 96Mbit/s on the PCMCIA interface. 96Mbit/s shall be supported if the front-end can provide higher bitrates than 72Mbit/s. This applies e.g. for the satellite front-end, which can provide up to 80.4 Mbps.

9.2.3 Minimum requirements for the NorDig CA-Module

9.2.3.1 General – the CA-modules

The CA-module may contain the CA security device (“CA-module with fully embedded CA-system”) or a smart card interface for connection to an external smart card (“CA-module with partly embedded CA-system”).

9.2.3.2 CA-module with fully embedded CA-system

The CA-module will be CA-system specific and contain all CA-functions, including the security device. For this case the relevant specifications have to be obtained from the relevant CA-system vendor.

9.2.3.3 CA-module with partly embedded CA-system

Proprietary CA-module (CIP-CAM or CI-CAM):

- The CIP-CAM or the CI-CAM will be connected to a security device (smart card).
- The CIP-CAM shall provide the CI-functions specified in the CI Plus specification [66] and the additional functions specified by the relevant CA-system vendor for the smart card interface.
- The CI-CAM (1) shall provide the CI-functions specified in EN 50221[9] and the additional functions specified by the relevant CA-system vendor for the smart card interface.

Note 1: Use of CI-CAM is not supported in all NorDig networks and may be phased out in most networks.

9.3 Use of Smart Card Reader

9.3.1 General

The smart card hardware with associated software can be used for conditional access and other purposes. This section will only consider use related to conditional access.

The smart card reader shall support an interface as partially specified in section 9.3.2 below and hardware/firmware for descrambling as specified in chapter 4. In addition there shall be filtering of ECM/EMM streams and program interfaces as specified below for conditional access.

The IRD shall be capable of replacing the CA-system software by download of new IRD and CA-system software via the bootloader, over air or locally.

9.3.2 The Smart Card Interface

9.3.2.1 All NorDig profiles

The embedded smart card reader is used with conditional access and/or other applications.

The smart card interface shall comply with ISO/IEC 7816 Part 1-3 [58]. The NorDig IRD does not need to support synchronous cards. The NorDig IRD shall implement all aspects related to asynchronous cards with the following exceptions:

- support for Vpp is not required
- support for AFNOR pin-out is not required
- Vcc range is 5V+/- 5%
- Icc max is 65 mA
- The clock frequency shall be at least 5 MHz.

The possibility of using the data exchange protocol T=0 shall be supported. It shall be possible to include support for the data exchange protocol T=1 through an IRD software upgrade.

9.3.3 ECM and EMM Filtering

The NorDig IRD shall implement ECM and EMM acquisition in accordance with ETSI ETR 289 [24].

The NorDig IRD shall be able to simultaneously acquire at least two ECM streams. The ECMs shall be filtered based on PID, TID and toggle bit.

The NorDig IRD shall be able to acquire EMMs from at least one EMM stream (one PID). The EMMs shall be filtered based on PID, TID and section address field. The section address field is CA system specific, and described as part of the smart card application interface. The IRD shall be able to filter on three TID and address field combinations simultaneously.

9.3.4 Descrambling of selected services

The NorDig IRD shall implement descrambling of selected services, see section 4.2.

9.3.5 Application Level Interface for Conditional Access.

The application level smart card interface for conditional access is CA-system specific. The application level interface definitions are restricted information that can be obtained from relevant CA-system vendors.

10 The System Software Update

10.1 General

The NorDig IRD shall provide a software download mechanism that enables download of software modules, to add a new software module or replace an existing software module. The modules may constitute a complete system, i.e. drivers, operating system and applications, or individual system components like updated parts of the system software or new applications. When individual components are downloaded, a mechanism shall be provided that assures that dependencies between separate modules are fulfilled. It shall be possible to replace all parts of the system software.

For NorDig IRD requirements related to updates of CIP CAM, see section 10.7.

Connected IRDs with an IP-based network connection to Internet (like a NorDig Hybrid IRD) may provide a range of additional services and content using the IP-based network (like broadband distributed media content, HbbTV content, web browsing, social media etc). The network connection is also the fastest and often most efficient way of applying software updates to such a Connected IRD, especially since the rapidly evolving service proposition for a connected IRD may necessitate regular updates. A connected IRD receiving updates in this way shall still arbitrate between software versions available via the broadcast network and the IP-based broadband network to ensure that only newer versions are downloaded and installed (according with section 10.1.4.2).

Note: The NorDig IRD may in addition to below requirements have other alternatives related to update of the IRD's system software.

10.1.1 User control of SSU

The upgrade of NorDig IRD software shall be initiated by the user (by update user preference setting and/or by user interaction). The user shall be able to choose the update approach for the IRD (see 10.2.1) and the user shall be able to disable any automatic update. See section 16 for the NorDig IRD requirements of user preference settings for SSU.

In cases where the user is prompted to confirm an update, the user shall be able to confirm or to abort/postpone the update (for example with a Yes and No option). If the user selects to abort/postpone an available update or by other ways cancel an available update, the NorDig IRD shall (1) remind the user as stated in section 10.1.6.

The user should be able to control when the installation will be performed, like proceed immediately or perform update in standby.

Note 1: Only mandatory with reminder for updates via broadcast channel and for IRDs where main FE is IP-based ("IPTV" IRD) that use SSU according to 10.4 (i.e. optional for System Software Updates via Internet).

10.1.2 SSU procedure

The NorDig IRD manufacturer shall provide the procedure and functions carrying out the upgrade in the IRD.

SSU procedure is here divided into following parts:

- Settings for SSU user preferences in the NorDig IRD (including factory default setting, see 16.4)
- Any user interaction during or starting of a SSU (confirmation of proceed update, user notification, manual update, etc)
- Search: IRD search for and detect if new System Software Update is available for the NorDig IRD (from broadcast, local interface and/or IP-based interface)
- Download: IRD download (cache) the System Software Update data file(s) to the NorDig IRD (from broadcast, local interface and/or IP-based interface)
- Install: IRD install of the downloaded System Software Update into the IRD's persistent memory and replacing the IRD's existing active software.

- Any re-installation of IRD and receivable services (if applicable, observe see section 10.1.5)

‘Automatic’ refers here to the IRD performing this in the background without user interaction (TV viewing mode or standby mode).

‘Manual’ refers here to the IRD performing this action first after user interaction (request and/or confirmation).

The NorDig IRD manufacturer should provide a mechanism for indicating when new system software is available for download (mandatory for some of the approaches, see 10.2.1).

10.1.3 User notification for SSU

Any notification to the user (pop-up message) related to SSU shall be displayed in the same language as the language setting of the IRD.

If the system software update does not allow the normal utilization of the NorDig IRD, the user shall be warned by some means. For example, by displaying information according to below if the display is available, and/or by a visual indication.

This User notification (prompt, pop-up message) about update shall (1) display at least the following information:

- If the system software update is expected to take more than 2 minutes in the operational mode, then display information that this update may take some time (preferably with approximation of expected time and/or displaying the progress of the download)
- If the system software update does not allow the normal utilization, then display information that warns the user about this (for example that there might be a black screen during this time).
- If the IRD has restriction of the usage to get a successful update then display information about these restrictions to get a successful update (for example that the user shall not turn off or remove the power cable to the IRD during this period).
- If the System software update affects or delete the IRD’s previous installation, user preference settings and/or service list(s), then before or after installation of a new system software, display information (2) about these effects of the update (for example if previous user preferences will be/have been erased).

This user notification about update should also display the following information:

- That the software update is required or recommended to improve the IRD usage.
- If the IRD can detect that the user had unplugged the power to the IRD when the IRD was prepared to perform an update when going to stand-by mode or during stand-by mode, then display information after start-up (1) to the user with an option to update immediate or at next stand-by (for example with a reminder to the user to not unplug the power to the IRD for this occasion).
- Indicate which network the user is connected to (in case of SSU via broadcast, then network information from NIT, SI, see section 12 and in case of SSU via local or IP-based interface, then information about the which interface).

If update is done in stand-by the notification should (1) then be displayed when the NorDig IRD is powered on next time.

Note1: This shall not apply when IRD starts automatically to perform scheduled actions, e.g. perform recordings. In this case no user notification shall be prompted on screen (and software download shall not be performed) or user notification shall have a mode that automatically times out this user notification and with a time-out of less than 5 minutes.

Note 2: Recommended also for NorDig IRDs that the system software update does not effects or delete the IRD’s previous installation, user preference settings and/or service list(s).

10.1.4 Security requirements for SSU

10.1.4.1 Protection against non-certified system-software

The IRD manufacturer shall ensure that download of non-certified system-software is prevented.

10.1.4.2 Only accept newer software versions

The NorDig IRD shall be provided with a mechanism ensuring that only newer software versions than the existing System Software are accepted.

10.1.4.3 Protection for corrupt system software

If the NorDig IRD System software is corrupt (due to normal operation of the IRD or due to updating the system software), the IRD manufacturer shall provide a backup mechanism, either on local storage or via download, which can make the IRD operational again.

10.1.4.4 Protection against interrupted SSU

The NorDig IRD shall be implemented with a protection mechanism for the existing system software. It shall ensure that the existing software will not be corrupted in case the System Software Update (SSU) is interrupted before the new system software is fully downloaded.

10.1.5 Previous user settings and installation after SSU

The NorDig IRD should avoid re-installation of user data (see chapter 16) due to a software update. All user preferences, user defined lists, etc, should remain unchanged.

10.1.6 Rejection and Reminder for SSU

If the user when asked chooses to postpone/abort/reject the current system software update:

- as long as the new system software is signalled over the broadcast channel (2), the NorDig IRD shall (1) remind the user each time the IRD comes out of stand-by or shutdown and the user shall be able to confirm or to abort/postpone the installation (3).
- When new system software is signalled over the broadband/return channel or local interface, the NorDig IRD may (1) remind the user at least once during next restart or shutdown of the IRD.

Note1: This shall not apply when IRD starts automatically to perform scheduled actions, e.g. perform recordings. In this case, no message shall be prompted on screen and software download shall not be performed.

Note 2: this refers to both cases when new system software is signaled and downloaded over broadcast channel and when new system software is signaled in broadcast but downloaded over broadband/return channel with the exception if new software can somehow be signalled as a non-important update.

Note 3: For the reminder, the NorDig IRD may offer a third alternative to permanently abort this update version, but then when an even newer update version is available the user shall be asked again.

10.2 Download via broadcast channels

The NorDig IRD shall be able to search for and download system software from the broadcast channel.

The NorDig IRD shall provide a software download mechanism in accordance with the DVB SSU specification [31]; the IRD shall support the SSU Simple Profile and the parts of SSU Enhanced Profile that are specified in section 10.5.

10.2.1 SSU alternatives and functionality

The NorDig IRD shall be able to have a setting that automatically searches for new system software over the broadcast.

The NorDig IRD shall implement at least two of the following defined approaches for software update functionality. The IRD manufacturer can decide on which of the approaches to implement:

- Fully Automatic – Automatic search, automatic download and automatic install (no user interaction when IRD set to this mode), see section 10.3.1.1 below.
- Semi Automatic – Automatic search, automatic download and manual install (auto regular search and download but wait for user confirmation before install), see section 10.3.1.2 below.
- Auto search but manual download and install (wait for user confirmation before download, install without further user confirmation), see 10.3.1.3 below.
- Manual search, manual download and install (manually initiated search, wait for user confirmation before download, install without further user confirmation), see 10.3.1.4 below.

The ability to implement the different approaches depends on the IRD's memory capabilities. NorDig recommends using the automatic search and download approach for IRDs with sufficient hardware capabilities. (For factory default, see section 16.3).

Automatic search refers here that the IRD regularly searches for new system software that targets the IRD according to 10.5.1. Automatic search may result in the detection of a system software download, in the case of SSU Simple profile, which can be immediately processed as per section 10.6 or a schedule time for a download to be available, in the case of Enhanced profile. The NorDig IRD shall at least support one of following alternatives for automatic search (regular searching for new system software):

- search continuously/frequently in the PSI/SI of the actual received broadcast signals in the background of normal operational without restricting the TV viewing and Navigation and should within 10 seconds but at least within 10 minutes after received signalling about new system software (see 10.6.1) start action according to the IRD's selected SSU approach.
- at least once per day in search through all installed Transport Streams (for example in stand-by mode). Any user notification shall be made after IRD comes out of stand-by according to 10.1.3.
- at least once from the time IRD has been turned off until the time it has been turned on (i.e. during stand-by mode) search through all installed Transport Streams, with exception for shorter stand-by periods than 10 minutes (to allow IRDs to have fast start-up if user changes their mind and wants to use the IRD again). Any user notification shall be made after IRD comes out of stand-by according to 10.1.3.

Note: IRDs may have one common user setting for selecting approach or several settings, for example one for download mode (auto/manual) and another for install mode (auto/manual).

10.2.1.1 Fully Automatic (auto search, auto download and auto install).

For this approach the NorDig IRD shall automatically perform a regular search for new system software, when new system software is available the IRD automatically downloads the new software in the background and when download is completed the new software shall be installed and replace the existing system software without any further user interaction.

This approach should mainly be used for IRDs that can perform System software upgrade without effecting or deleting the IRD's previous installation, user preference settings and/or service list(s).

It is recommended for this approach that actions that limit or disturb the use of the IRD (e.g. download and installation) is performed when the IRD is not used by the user or the user's scheduled actions (e.g. when going to stand-by mode or during stand-by mode).

10.2.1.2 Semi-Automatic (Automatic search, automatic download and Manual install)

For this approach the NorDig IRD shall automatically perform a regular search for new system software and automatically download the new software in the background when available. Once the software download is completed, the NorDig IRD shall give a message to the user that software is ready to be installed (according to 10.1.3). The user shall be able to control the update as stated in 10.1.1 and be reminded as stated in 10.1.6.

If the user selects to confirm upgrade then NorDig IRD shall install the downloaded new system software without any further user interaction and may provide warning messaging if installing the update interrupts viewing (according to 10.1.3).

10.2.1.3 Automatic search, manual download and install

For this approach the NorDig IRD shall automatically perform a regular search for new system software and whenever new software is available, prompt the user with a pop-up message (according to 10.1.3). The user shall be able to control the update as stated in 10.1.1 and be reminded as stated in 10.1.6.

If user selects to confirm upgrade then NorDig IRD shall download and install the new system software without any further user interaction and may provide warning messaging if installing the update interrupts viewing (according to 10.1.3).

10.2.1.4 Manual search, manual download and install

The NorDig IRD should support a Manual Software Update option (referring to manual search for new software, see 10.6.4).

For this approach, when selected by the user, NorDig IRD shall initiate an immediate search for new software and before or after downloading the new system software, prompt the user with a pop-up message if an update is available or not (for example with a user confirmation to proceed or that no new software is available). The user shall be able to control the update as stated in 10.1.1. (The NorDig IRD should here not remind the user of the new system software, if the user selects to abort an available update).

If user selects to confirm upgrade then NorDig IRD shall download (if not already downloaded) and install the new system software without any further user interaction and may provide warning messaging if installing the update interrupts viewing (according to 10.1.3).

10.2.2 IRDs with access to multiple SSU services

When the NorDig IRD has access to multiple SSU services following shall apply:

1. Only SSU streams targeting the IRD (brand, model etc) shall be accepted by the NorDig IRD (and the NorDig IRD shall not be disturbed by other SSU streams for other IRD brands and/or models).
2. Only SSU streams with a higher software version than already installed shall be accepted by the IRD (according with section 10.1.4.2).
3. The IRD manufacturer shall ensure that there are not any compatibility issues if different System Software versions are broadcast via different operators (1). In case there are different certified System Software versions available for different networks, the IRD shall indicate to the user if the new System Software is not certified for the same network as the existing System software.

Note 1: In some cases an IRD might have access to two or more download services, carrying software updates with different version numbers, possible from different operators/networks, different channels (via broadcast channels and/or via local data interface). In this case toggling between different software versions has to be avoided.

Individual networks may have network specific requirements in addition to the common NorDig requirements. In such cases the IRD will have to satisfy both the common NorDig requirements and the relevant network specific requirements in order to provide certified system software for the networks

10.3 Download via local interface or IP-based interface

Download should be possible using a local data interface (like USB) and/or IP-based interface (see chapter 8.3). The NorDig IRD manufacturer shall define the protocols and security mechanisms. The actual download is the user's responsibility and shall be performed under the full control of the user.

10.4 Network Management and Provisioning

NorDig IRDs with an IP-based front-end should support system software download through network management and provisioning as specified in ETSI TS 102 034 [31], Chapter 10.

Note: Network management and provisioning specifies how NorDig IRDs with an IP-based front-end network configuration shall be provisioned, and how NorDig IRDs with an IP-based front-end will be managed over an IP network.

10.5 The System Download Mechanism via broadcast channels

10.5.1 SSU Signaling

10.5.1.1 Simple Profile

The NorDig IRD shall support the SSU simple profile using the signaling in NIT, BAT and PMT, in accordance with the DVB-SSU specification [31]. The Linkage descriptor in the NIT table, for linking to the SSU service is defined in section 12.2.6 (The UNT is not used for this profile, see chapter 5 of ref ETSI TS 102 006 [30]).

10.5.1.2 UNT Enhanced Profile

The NorDig IRD shall support the SSU UNT Enhanced profile using the signaling in NIT, BAT, PMT, and UNT, in accordance with the DVB-SSU specification [31]. The Linkage descriptor in the NIT table, for linking to the SSU service is defined in section 12.2.6. The descriptors of the UNT Enhanced profile shall be as specified in Section 12.7.

Descriptors defined in the DVB SSU Enhanced profile [31], but not specified as mandatory in section 12.7 may be omitted.

10.5.1.3 Locating the Appropriate SSU

Two principal ways of signaling SSU shall be supported.

1. Use of DVB OUI

In this case, selection is done by further investigating into PMT (and also UNT if Enhanced profile is used).

2. Use of Manufacturer specific OUI

Use of Manufacturer specific OUI and selector bytes to indicate model type or ranges of models:

- a. The NorDig IRD shall access the relevant SSU service without investigating other services if the triggering conditions given by the selector bytes are met.

- b. If the NorDig IRD is already updated with the updated software (i.e. signalled version number is the same as the one in the IRD), there is no need to investigate further into the PMT, UNT or Data-carousel (only NIT needs to be checked).

Table 10.1 shows typical signaling in PMT and NIT that shall be handled by the NorDig IRD:

Manu- facturer	Model/ version	Enhanced/ Simple without UNT	Service_ID	PMT Data_broadcast ID_descriptor	NIT Linkage_descriptor
1	1	Simple	1	Manufacturer specific OUI with selector bytes.	Manufacturer specific OUI with selector bytes.
1	2	Simple	2	Manufacturer specific OUI with selector bytes.	Manufacturer specific OUI with selector bytes
1	3	Enhanced	3	DVB OUI	DVB OUI
2	1	Enhanced	3	DVB OUI	DVB OUI
3	1	Enhanced	3	DVB OUI	DVB OUI
4	1	Enhanced	4	Manufacturer specific without selector bytes	Manufacturer specific without selector bytes

Table 10.1 Example of signalling in the PMT and NIT

For signaling in the PMT, two principal ways shall be supported.

1. Data_broadcast_ID_descriptor using DVB OUI:
- Further investigation in UNT and Data-carousel needed to locate the software image.
2. Data_broadcast_ID descriptor including manufacturer specific OUI and selector bytes:
- The IRD shall investigate the hardware ID and the software ID from the selector bytes in the PMT table. The IRD shall only trigger on a software update as long as the software ID is higher than the currently installed software in the IRD.
 - If the triggering conditions are met, the IRD shall investigate the UNT to find out if a software update is targeted to this specific IRD.

10.5.2 Update Notification Table (UNT)

The use of the Compatibility_descriptor, including hardware and software descriptors shall be supported by the NorDig IRD, in accordance with ETSI TS 102 006 [30].

Any table section and carousel group referring to a specific OUI that does not match the IRD's OUI shall be ignored by the IRD. The NorDig IRD shall be robust against any non-compliance of such transmitted data not intended for NorDig IRD use.

10.5.3 Data carriage

Both standard data and proprietary data formats shall be supported as specified in ETSI TS 102 006 [30].

The definition of the proprietary format is up to the IRD manufacturer (In accordance with ETSI TS 102 006 [30]).

The IRD shall (1) support standard DVB data carousel in accordance with ETSI TS 102 006 [30].

Note 1: Several system software updates, for a number of different IRDs may be transmitted as groups in this carousel. The DownloadServerInitiate message (DSI) will be used as the entry point in the carousel and may be shared by multiple manufactures.

One manufacturer can have multiple updates, each update in a separate group. It is assumed that all groups and modules can be transmitted on a shared elementary stream.

10.5.3.1 Minimum bandwidth for SSU over broadcast channel

The NorDig IRD should support SSU file broadcasted with bitrate down to 100 kbps (without IRD timing out due to slow download).

10.6 CIP-CAM software updates

In the case of IRDs with CIP- CAM, the IRD shall also support to update the System Software on the CIP-CAM when such software is broadcast. In this case there could be two software images. The IRD shall inform the user whether there is an IRD update or CIP-CAM update.

All requirements in this chapter apply to NorDig IRDs. Requirements for download functions in the CIP-CAM are defined in the CI Plus specification [66].

11 Performance

11.1 Introduction

In this chapter the performance of decoded digital video and audio signals are specified (only relevant for IDTV in case of external interfaces). It also includes zapping performance regarding the time to recover when changing services. The performance for demodulated analogue video and audio signals (optional for NorDig IRD with embedded analogue cable front-end) is also specified.

Other performance issues are treated in other chapters.

11.2 Video Performance of RGB and PAL Signals

The RGB- and CVBS-signals at the appropriate interfaces of the NorDig IRD shall meet the characteristics given in ITU report 624-4 [61].

11.3 Audio Performance of the Decoded Digital Signal

Reference for the performance of all audio measurement is full scale minus 12 dB and the measurement shall be made at a sampling rate of 48 kHz.

The NorDig IRD shall at least satisfy the performance as stated below:

Measurement item	Min	Typical	Max.
Output impedance (Ohm)		600	1000
Output level for sine wave at 1kHz of 0 dBTP (mV RMS)	1590 (i.e. -1 dB) (note1)	2000 (note 1)	2520 (i.e. +1 dB) (note 1)
Output level for sine wave at 1kHz of -12 dBTP (mV RMS)	397 (i.e. -1 dB) (note 1)	500	630 (i.e. +1 dB) (note 2)
Flatness of amplitude response: (dB)(at 40 Hz to 80 Hz) 80 Hz to 13,5 kHz 13,5 kHz to 20 kHz	-2 -1 -2		+2 +1 +2
Dynamic range (dB)	80		
Harmonic distortion ratio (%)			0.1
Cross-talk between channels (dB, at 20 Hz to 20 kHz)			-60
Hum suppression (dB)	60		
S/N (dB, weighted, quasi peak, ITU/R rec. 468)	66		
Phase difference between channels (°), 40 Hz to 13,5 kHz 13,5 kHz to 15 kHz			10 15
Amplitude difference between channels (dB, 20 Hz to 20 kHz)			±1
Volume control (affected steps with 3 dB/step)		6	
Signal attenuation at mute (dB)	70		

Table 11.1 Audio performance

Note: Full scale is defined, for a digital signal, as the maximum signal in accordance with the encoding system specification. Full scale amplitude is defined after pre-emphasis and is the same for all frequencies after encoding.

Note 1: Optional for NorDig IRD released before 1 July 2015.

Note 2: NorDig IRD released before 1 July 2015 may have a maximum of 2000 mV RMS.

11.4 Zapping Time for TV Services

The NorDig IRD's zapping time for the services shall satisfy the requirements given in Table 11.2.

The figures in Table 11.2 shall be met for an input signal which has:

- video GOP length of 12,
- a repetition rate of ECM of 2 per second (for scrambled services)
- repetition rate of PAT and PMT of 10 times per second and
- maximum PTS-to-PCR relative delay shall be 700ms.

The picture on the display during the zapping time shall be either frozen or black and the sound shall be muted until the new session has been stabilised.

The figures in the table are valid for two services on one multiplex as well as for two multiplexes and for both scrambled and unscrambled (FTA) services.

IRD Type	Average max zapping time
IRD with embedded CAS	2.5 seconds
IRD with CI and using a CAM	3.5 seconds

Table 11.2 Maximum zapping time

Note: An IRD may have several methods of changing selected service to be decoded (zapping), for example via P+/P-, service list, numeric keys, from EPG/ESG menu etc. The different methods of zapping may have slightly different zapping time, for example due to response time, time-out for keying etc. Figures above are for the IRD's fastest method, other method should not introduce more than 1s of extra zapping time. Observe that CAMs from different vendors can have different performance and this can have an impact on the zapping time. Figures above are for CAMs with well proven performance. Different CAS broadcast settings (e.g. CI+ messages) can also impact on the zapping time, which must be taken into account when evaluating the result. Figures above are for CAS broadcast settings with fastest zapping time.

Part B: The system software with application

12 Service Information

12.1 General

12.1.1 General Requirements

The NorDig IRD shall be able to process, i.e. sort out, store and make available through the Man-Machine Interface (NorDig Basic) the incoming SI data (descriptors) as tabulated in sections 0-12.8, i.e. these are (minimum) mandatory descriptors for the receiver to decode and interpret, (see also Table 12.2 for an overview over minimum broadcast and receiver requirements). The processing shall be compliant with EN 300 468 [15] and ETSI TR 101 211 [27].

The NorDig IRD with an HbbTV-based profile (NorDig Hybrid shall support all the DVB SI additions as defined in the HbbTV v. 1.5 ETSI TS 102 796 v.1.2.1 specification [29].

Descriptors or other data structures that are currently undefined or are unknown to NorDig IRD shall be skipped and shall not cause any harm.

The NorDig IRD shall be able to process the PSI/SI tables, both for the ‘Actual’ and for ‘Other’ transport streams. SI tables for the ‘Other’ transport streams, SI_{other} , should be seen as informative and shall always be double checked with the corresponding SI tables for the ‘Actual’ transport stream, SI_{actual} .

The NorDig IRD shall at least start updating for any changes in the received “quasi-static” SI data after it returns to active from stand-by mode. “Quasi static” SI-data includes NIT and SDT, i.e. SI that is typically stored in the flash memory for service navigations, such as service name, service_ID, number of services. (The ‘running status’ is not included in the quasi-static SI data. As a guideline for the implementation, this updating may be performed in the background, to shorten the start-up of the basic video and audio).

The NorDig IRD shall at least start action for any changes in the received “dynamic” PSI and SI data, (PMT, EIT, TDT/TOT, running status and CA mode) within 1 second. (As a guideline for the implementation, the trigger for changes in received tables can be based on comparing the ‘version id’ in the tables).

NorDig IRDs with IP-based front-end shall support “TS Full SI” and should support “TS Optional SI”, as specified in ETSI TS 102 034 [31]. With respect to DVB SI as specified in ETSI EN 300 468 [15], the following general requirements and comments apply:

- a) The NorDig IRD with IP-based front-end shall process the following DVB SI tables if present in the transport stream (see also Table 12.1):
 - Service Description Table (table_id = 0x42 – Actual transport stream)
 - Event Information Table, Present/Following and Schedule
 - Time and Date Table/Time Offset Table
See section 12.5 for complete procedure to retrieve network time.
 - Conditional Access Table (CAT)
 - Programme Map Table (PMT)
- b) For NorDig IRDs with IP-based frontends the NIT is not used. Instead the IRDs shall (1) look for the Service Provider Discovery Information as defined in ETSI TS 102 034 [31]. The entry point(s) for Service Provider Discovery Information shall be according to the mechanisms defined in ETSI TS 102 034 [31]. A service list shall be built based on the information in the Service Provider Discovery Information. See also Annex C.

- c) In order to locate possible bootloader streams retransmitted from e.g. satellite, the NorDig IP IRD shall (1) look in the Broadcast Discovery Record (according to ETSI TS 102 034 [31]). A bootloader service shall be signaled as a particular service with service_type set to 0x81.

Note 1: Use of ETSI TS 102 034 is suspended, as it is currently not used in most IP-based networks. For information about required performance related to this item, contact the relevant network operator.

As the NorDig IRD needs information like manufacturer, HW version, SW version etc., the NorDig private Linkage Descriptor shall be included in the Broadcast Discovery Records. The XML scheme of the private Linkage Descriptor is given in section 13.4.

12.1.2 PSI/SI classification

Static PSI/SI data is defined as the PSI/SI data that must be updated by the IRD in Installation mode (channel search or first time initialization).

Quasi static PSI/SI data is defined as the PSI/SI data that must be updated by the IRD in (automatic) Update mode (i.e. when it is toggled between stand-by mode and active mode or vice versa).

Dynamic PSI/SI data is defined as the PSI/SI data that must be updated by the IRD in active/TV viewing mode (i.e. within 1s after a change in the data occurs).

12.1.3 Private data specifier value

NorDig defined private descriptors and data inside PSI and/or SI tables are recognised with private_data_specifier_value set to 0x00000029, used according to ETSI TR 101 211 [27] and ETSI ETR 162 [23].

12.1.4 Service Types

The NorDig IRD shall minimum handle the service types listed in Table12.1 below.

Service types that are not supported by the NorDig IRD should be ignored.

Class of service (description of service type)	Service type	Status	Category type	Priority within category
basic TV service (mainly MPEG-2 based SDTV)	0x01	<i>M</i>	<i>TV</i>	<i>3</i>
Radio service (mainly MPEG-1 Layer II based)	0x02	<i>M</i>	<i>Radio</i>	<i>2</i>
Teletext service	0x03	<i>M</i>	<i>Others</i>	
Advanced codec based Radio service (MPEG-4 AAC including HE-AAC and E-AC-3)	0x0A	<i>Alt (2)</i>	<i>Radio</i>	<i>1</i>
Data broadcast service (e.g. for SSU service) and HbbTV standalone services	0x0C	<i>M</i>	<i>Others</i>	
Advanced codec based SDTV service (MPEG-4 AVC)	0x16	<i>M</i>	<i>TV</i>	<i>2</i>
Advanced codec based HDTV service (MPEG-4 AVC)	0x19	<i>M</i>	<i>TV</i>	<i>1</i>
<i>Others</i>	<i>others</i>	<i>O</i>	<i>Others</i>	
M; Mandatory, R; (Highly) Recommended, O; Optional item to support, Alt; minimum one among several options				

Table12.1 Overview of service types, service category groups and priority between the service types

Informative: During migration period simulcasting of the content in (MPEG2) SDTV and in (MPEG4 AVC) HDTV may occur. Simulcasting may be under the same service (service_id) or on separate services (separate service_ids).

For service simulcasting on separate service_ids a linkage 'NorDig Simulcast replacement service' (linkage type 0x82) will be broadcasted from the SDTV version pointing to the HDTV version of the same service, in order to help the IRD to know that these services are two versions of the "same" service/content,

The service types 'Advanced codec based Radio service' (0x0A), 'advanced codec based SDTV service' (0x16) and 'advanced codec based HDTV service' (0x19) will be used for services main component is an advanced codec stream. For TV services the main component is the video stream while for Radio services the main component is the audio stream. These service types will be used when it is not desirable that an "old" M2 level only IRD install and list a MPEG4 service.

The service type 'digital TV service' (0x01) will be used for services including MPEG-2 video stream. It may also be used for service simulcasting MPEG2 and MPEG4 AVC video and for service only including MPEG-4 AVC video. All IRDs will install service type 'digital TV service' (0x01). This service types (0x01) will be used for a service that only includes MPEG-4 AVC video when it is desirable that an "old" M2 level only IRD installs and lists a service (even if the M2 level only IRD can not decode the video, used for promotion purpose).

The logic channel number shall, as far as possible, be unique within each original network id for each service type category (TV, Radio and Others).

12.1.5 Service Categories

The services are grouped into three service type categories; TV (1), Radio (2) and Others/data (3) services:

- (1) TV category includes services with service type; 0x01 digital (MPEG-2) TV service, 0x16 advanced codec SD TV service and 0x19 advanced codec HD TV service.
- (2) Radio category includes services with service type; 0x02 digital radio sound service and 0x0A advanced codec digital radio sound service.
- (3) Others/(data) category includes all other service types that are not included in TV (1) and Radio (2) categories.

The NorDig IRD shall during installation of services create a common service list for each category (i.e. all 0x01, 0x16 and 0x19 within same TV category list and so on for the Radio and Other/data categories).

Informative: These categories enables the IRD to create a common TV category service list for all TV service types (0x01, 0x16 and 0x19) and similar for Radio and Other/data service lists.

CI_protection_descriptor	0xCE			Mr(6)				
Forbidden	0xFF	Fb	Fb	Fb	Fb	Fb	Fb	Fb
- Descriptor not applicable or not yet used as minimum within NorDig								
Mb Mandatory to Broadcast, always/all time mb Mandatory to Broadcast if applicable, i.e. if certain criteria is met (e.g. if scrambling is used) Ob Optional to broadcast, but recommended (if applicable) Fb Forbidden to broadcast (may cause misinterpretation) Mr Mandatory to receive and interpret if broadcast Or Optional to receive and interpret (if broadcasted) * Optional for satellite and cable IRDs.								
Note 1: Mandatory for IRD with HbbTV API based profiles Note 2: Mandatory to broadcast, in accordance with ETSI TR 101 211 [27]. Note 3: Descriptors carried in the NIT are not relevant for IRDs with IP-based Front-end, see Annex C Note 4: NorDig PVR only. Note 5: Only applicable for NorDig IRD-T2 Note 6: Mandatory to receive from SDT-actual for IRDs that support use of CIP-CAMs, see section 9.2 Note 7: The value of component_type to be used within the component_descriptor shall be equal to the value of component_type held in the AC-3_descriptor or Enhanced_AC-3_descriptor or AAC_descriptor Comment: Descriptors used for the UNT of the DVB SSU Enhanced profile are given in table 12.2 Descriptors used for the RCT (only applicable for PVRs) are given in table 12.21								

Table 12.2 Overview over minimum used descriptors in NorDig broadcast and receivers

Descriptor	Tag extension value	NIT (1)	BAT	SDT	EIT	TOT/TDT	CAT	PMT
T2_delivery_system_descriptor	0x04	mb Mr	-	-	-	-	-	-
Supplementary_audio_descriptor	0x06							mb Mr
reserved for future use	0x09-0x7F	-	-	-	-	-	-	-
user defined	0x80-0xFF	-	-	-	-	-	-	-
Descriptor not applicable or not yet used as minimum within NorDig mb Mandatory to Broadcast if applicable, i.e. if certain criteria is met (e.g. if scrambling is used) Mr Mandatory to receive and interpret if broadcast								
Note 1: Descriptors carried in the NIT are not relevant for IRDs with IP-based Front-end, see Annex C								

Table 12.3 Overview over minimum used descriptors in the extension_descriptor in NorDig broadcast and receivers

12.1.7 Character sets in text strings

The NorDig IRD shall support the character tables specified in Table 12.4. Respective character table in NorDig transmission is signaled by using bytes in the beginning of text field according to ETSI EN 300468 Annex A.2 [15] and as reproduced for convenience in Table 12.4.

Table description	Character code table	First byte	Second byte	Third byte
Latin Alphabet	ISO/IEC 6937+ €(2)	N/A	N/A	N/A
Latin Alphabet No. 5	ISO/IEC 8859-9	0x05	N/A	N/A
Western Europe	ISO/IEC 8859-1	0x10	0x00	0x01
North and North-East European	ISO/IEC 8859-4	0x10	0x00	0x04
Latin Alphabet No. 9	ISO/IEC 8859-15	0x10	0x00	0x0F

Table 12.4 Character tables and signaling bytes in the beginning of text string

Note 1: The table above is relevant for text strings in SI and ESG.

Note 2: This table is referred in ETSI EN 300468 as Figure A1: Character code table 00-Latin Alphabet. This table is ISO/IEC 6937 plus Euro-sign (€). This is the default character set to be used if no particular character set is given (ref ETSI EN 300468, Annex A.2 [15]).

Note 3: The requirements for character table support can also be specified by the network/CA operator.

12.1.8 Country and Language Codes within PSI/SI

Preferably all (main) country codes in ISO 3166 and all Alpha-3 language codes in ISO 639-2 should be handled. Due to the quite large number of codes in these specifications, Table 12.5 and Table 12.6 specifies the minimum types of codes that shall be handled by the NorDig IRD including the recommended translations. NorDig IRDs intended only for a specific network, the operator(s)/regulator(s) in charge for specifying the functionality of the IRD for that network and ensuring that the minimum requirements are met, may exclude some of the mandatory country and language codes.

NorDig has defined the language code ‘nar’ as “narrative”, that may be used for supplementary audio streams (audio description etc).

Country (in English)	ISO 3166 code	Translation to be used (to native)	Possible to select as user’s preferred country
SWEDEN	SWE	Sverige	Mandatory
DENMARK	DNK	Danmark	Mandatory
IRELAND	IRL	Éire	Mandatory
FINLAND	FIN	Suomi	Mandatory
NORWAY	NOR	Norge	Mandatory

Table 12.5 ISO 3166, Country codes for NorDig IRDs

Language (in English)	ISO 639-2	Translation to be used in DTT	Possible to select as user’s preferred languages	Comments
	Code	To native		
Danish	dan	Dansk	mandatory	
English	eng	English	mandatory	
Finnish	fin	Suomi	mandatory	
Irish / Gaelic	iri	Gaeilge	mandatory	ISO 639-2 Bibliographic
Irish / Gaelic	gle	Gaeilge	mandatory	ISO 639-2 Terminological
Norwegian	nor	Norsk	mandatory	
Narrative	nar		recommended (optional)	may be used for supplementary audio streams

Original language	qaa	Original (dan) Original (eng) Alkuperäinen (fin) Bunaidh (gle) Original (nor) Original (swe)	recommended (optional)	See DVB SI spec ETSI 300468 Annex F for “original audio”
Sami	smi	Sámegiella	mandatory	
Swedish	swe	Svenska	mandatory	
Undefined	und	Udefinieret (dan) Undefined (eng) Määrittelemätön (fin) Neamhshainithe (gle) Undefined (nor) Odefinierat (swe)	optional	treated same as original language (qaa)

Table 12.6 ISO 639-2 Language codes for NorDig IRDs

Note 1: Optional for NorDig IRD released before 1 July 2015.

12.2 Network Information Table (NIT)

12.2.1 The Network information Table Descriptors

NIT descriptors	Cable IRD	Satellite IRD	Terrestrial IRD
Metadata_pointer_descriptor (3)	Optional	Optional	Optional
Network_name_descriptor	Mandatory	Mandatory	Mandatory
Service_list_descriptor	Mandatory	Mandatory	Mandatory
Satellite_delivery_system_descriptor	n/a	Mandatory	n/a
Cable_delivery_system_descriptor	Mandatory	n/a	n/a
Terrestrial_delivery_system_descriptor	n/a	n/a	Mandatory
T2_Terrestrial_delivery_system_descriptor (2)	n/a	n/a	Mandatory (2)
Linkage_descriptor	Mandatory	Mandatory	Mandatory
Private_data_specifier_descriptor	Mandatory	Mandatory	Mandatory
Frequency_list_descriptor	Optional	Optional	Mandatory
default_authority_descriptor (3)	Mandatory (3)	Mandatory (3)	Mandatory (3)
(NorDig) logic_channel_descriptor (Version 1)	Mandatory	Mandatory	Mandatory
(NorDig) logic_channel_descriptor (Version 2)	Mandatory	Mandatory	Mandatory

Table 12.7 NIT descriptors

Note 1: The NIT is not used with NorDig IRDs with IP-based frontends. Hence if NIT is transmitted, the NorDig IP IRDs shall ignore this table. Instead, the information provided by the NIT will be replaced by the Service Discovery and Selection mechanisms, specified in Section 13.4.

Note 2: Descriptor is signaled in the extension_descriptor and only applicable for NorDig IRD T2.

Note 3: NorDig PVR only.

12.2.2 Metadata Pointer Descriptor (NorDig PVR only, Broadcast Record Lists)

This metadata pointer descriptor (see syntax ISO/IEC 13818-1 and additional description DVB/ETSI TS 102 323) is applicable for IRD supporting NorDig Broadcast record Lists.

For metadata pointer descriptor that is delivered in the NIT, refers that the metadata (NorDig Broadcast record Lists) is valid for the network (*ie original_network_id*). Located in NIT first common descriptor loop metadata pointer descriptor.

The value of the fields in the metadata pointer descriptor will be set as following signifying the metadata contained conforms to the NorDig BRL:

Metadata pointer descriptor fields	Value/description	Remark
metadata_application_format	0x0100	NorDig uses TV Anytime and DVB standard value 0x0100, (while DTG uses value 0x0101)
metadata_format	0x3F	the IRD shall use the metadata_application_format value to interpret the format of the carried metadata
metadata_locator_record	0b0	
program_number	service_id	
transport_stream_location	original_network_id	

Table 12.8 NorDig BRL's Metadata pointer descriptor field usage

12.2.2.1 Metadata Descriptors Extension

The metadata descriptor extension is included in both the metadata pointer descriptor and metadata descriptor, according with DVB/ETSI TS 102 323. However, the metadata descriptors extension found in the metadata descriptor shall have priority in the NorDig IRD over the metadata descriptors extension found in the metadata pointer descriptor.

The value of the fields in the metadata descriptor will be set as following signifying the metadata contained conforms to the NorDig BRL:

Metadata pointer descriptor fields	Value	Remark
DVB carriage format	0x0	align with TS102 323, section 9.2 Delivery of Containers
metadata service identifier flag	0b0	

Table 12.9 NorDig BRL's Metadata pointer descriptor field usage

The fragment types list may appear in the broadcast. NorDig PVR support NorDig BRL shall operate correctly in the presence of them.

The metadata_service_identifier will be included and is used to identify the NorDig Broadcast Record List metadata service as profiled in DVB/ETSI TS 102 323 clause 9.6.

The user_data_bytes in the metadata descriptor extension shall carry a default group authority structure as defined in 12.2.2.2 below.

12.2.2.2 Default Group Authority Structure

The default group authority structure shall convey the authority for the default Record List group CRID.

Syntax	No. Of Bits	Identifier
Default_group_authority_structure(){ authority_string_length for (i-0;i<authority_string_length;i++){ authority_byte } for (i-0;i<N;i++){ user_data_byte } }	8	uimsbf
	8	uimsbf
	8	Bslbf

Table 12.10 Default Group authority structure

authority_string_length: The number of authority_bytes in the authority_string.

authority_byte: This byte forms part of a string representing the default group authority.

12.2.3 Cable Delivery System Descriptor

Reference to analogue services (PAL) may be used in NorDig digital (cable) networks. These services will be signalled in the SI as an own “transport stream”. The `cable_delivery_system_descriptor` for these analogue services will contain the correct centre frequency for the (PAL) vision carrier, while the other delivery parameters will be set to zero (i.e. not defined; FEC Outer = 0, Modulation = 0 etc). The `service_list_descriptor` for this “transport stream” (analogue service) will list only one TV service, with `service_type` set according to Table 72 in EN 300 468 [15] (0x07, PAL coded signal).

12.2.4 Terrestrial Delivery System Descriptor

NorDig IRDs should use the modulation parameters (see below) in the `terrestrial_delivery_system_descriptor` as a recommendation when trying to tune to a multiplex. The NorDig IRD should, however, always be able to detect the modulation from the transmission itself (e.g. assisted by TPS bits).

Operators can broadcast the same transport stream in the same network using different modulation parameter settings. This allows for optimization of the network coverage in frequency planning involving SFN and MFN combination networks.

The modulation parameters carried in the `terrestrial_network_descriptor` are recommended to be the one applicable to the majority of receivers in that network.

12.2.5 T2 Delivery System Descriptor

`T2_delivery_system_descriptor` is signaled in the `extension_descriptor`.

The NorDig IRD-T2 shall use the system parameters in the `T2_delivery_system_descriptor` to determine the mapping between `original_network_id/network_id/transport_stream_id` and `T2_system_id/plp_id`.

The NorDig IRD-T2 should use the other system parameters in the `T2_delivery_system_descriptor` as a recommendation when trying to tune to a multiplex. The NorDig IRD-T2 should, however, always be able to detect these system parameters from the transmission itself (i.e. assisted by L1 signaling).

Operators can broadcast the same transport stream in the same network using different system parameter settings, reflected in a different `T2_system_id`. This allows for optimization of the network coverage in frequency planning involving SFN and MFN combination networks.

12.2.6 Linkage Descriptor

The following `linkage_type` values shall be interpreted by a Nordig IRD, when used inside the NIT

- 0x01, linkage to a service that contain information about the network
- 0x02, linkage to an EPG service (1)
- 0x04, linkage to transport stream which carries EIT schedule information for all of the services in the network (i.e. “barker channel” service).
- 0x09, linkage to DVB System Software Update service (bootloader), see section 10

Note 1: Not relevant for NorDig Basic

12.2.7 Frequency List Descriptor

The Frequency List Descriptor lists frequencies where the transport stream occurs, in addition to the frequency given by the system delivery descriptor. (e.g. the transport stream is broadcast on the frequency given by the system delivery descriptor or broadcast on one of the frequencies given by the frequency list descriptor. This feature can be used in terrestrial networks where the same transport stream can be received on more than one frequency.)

12.2.8 Default authority descriptor (in NIT) (NorDig PVR only)

The Default Authority Descriptor (DAD), defined in DVB document Carriage and signalling of TV-Anytime (TVA) information ETSI TS 102 323 [34], may be used to shorten the CRIDs carried within EIT by defining an appropriate CRID default authority over a defined scope.

The DAD may be used in first loop of NIT to set a common Default Authority (DA) for all services within that Network. It may also be used in second loop (TS loop) to set a common Default Authority for all services within a Transport Stream.

The prefix “crid://” may be omitted from the start of the text string in the Default Authority in the NIT (both first or second loop). See separate section about CRID usage in 12.4.6

As described in ETSI TS 102 323 [34], where an event in the EIT does not have a complete URL within the Content Identifier Descriptor (CID) (i.e. a CRID starting with '/'), the NorDig PVR IRD shall:

- Use default authority (DA) defined for this service in the SDT.
- If no default authority is defined in the SDT, the PVR shall use the default authority in the second TS loop of the NIT for the actual transport stream this service belongs to.
- If no default authority is defined for the actual transport stream in second loop of NIT, the receiver shall use default authority in first loop in NIT for the network this service belongs too.

Example of handling of CRID together with Default authority values.

Broadcast signalling		
DAD , Default Authority Descriptor in NIT, first loop	Default authority: 'network.se'	
in NIT, second loop for TS1	'ts1.network.se'	(no other TS has default authority in NIT TS loop)
in SDT, service 1 of TS 1	'provider_A'	(no other services has default authority in SDT)
<i>Service 1 in TS 1, Service 2 in TS 1 and Service 3 in TS 2 have all events with above Event1 and Event2</i>		
CID , Content Identifier descriptor	CRID in EIT for services:	
Event1	'/abc/soap_event12345'	Example with non-complete CRID
Event2	'abc/soap_event6789'	Example with complete CRID
Receiver CRID compilation		
Interpretation within IRD of CID + DAD		
Service 1 belonging to TS 1	Event 1	crid://Provider_A/abc/soap_event12345
Service 1 belonging to TS 1	Event 2	crid://abc/soap_event6789
Service 2 belonging to TS 1	Event 1	crid://ts1.network.se/abc/soap_event12345
Service 2 belonging to TS 1	Event 2	crid://abc/soap_event6789
Service 3 belonging to TS 2	Event 1	crid://network.se/abc/soap_event12345
Service 3 belonging to TS 2	Event 2	crid://abc/soap_event6789

12.2.9 NorDig private; Logic_Channel_descriptor (LCD)

12.2.9.1 General

The logic channel descriptor is used in the second descriptor loop in the NIT, i.e. in each “TS loop” (1). Several LCDs may be listed in each TS loop.

Note 1: In one NorDig satellite network, the NorDig LCD will be carried in the SDT.

Data in this descriptor shall be treated as quasi-static and is used to order services in the IRD’s default **service lists**. The descriptor enables an IRD to create a (first time) default order of the services in the IRD’s service lists controlled by the operator, observe that this shall not affect the end-user defined lists in the IRD, if any.

Comment: The wording ‘Channel List’ refers here to the transmission side and this LCD is used to transmit a Channel List, while the ‘Service List’ refers to the IRD’s stored list of services. The IRD uses the transmitted LCD Channel List data among other SI data to create, update and sort services of its own default Service List).

12.2.9.2 NorDig private; Logical Channel Descriptor (version 1)

Note: This older version of the NorDig Logical Channel Descriptor is in some NorDig Networks replaced by the newer version 2 below.

12.2.9.2.1 Syntax of LCD version 1

The syntax of the Logical Channel Descriptor (version 1) is shown in Table 12.11.

Syntax	No. of bits	Identifier
logical_channel_descriptor(){		
descriptor_tag	8	uimsbf
descriptor_length	8	uimsbf
for (i=0;i<number_of_services;i++){		
service_id	16	uimsbf
visible_service_flag	1	bslbf
reserved	1	bslbf
logical_channel_number	14	uimsbf
}		
}		

Table 12.11 Logical_Channel_descriptor (LCD v1)

descriptor_tag: This shall be assigned to be 0x83 (decimal 131)

visible_service_flag: This 1-bit field when set to ‘1’/’true’ indicates that the service is normally visible and selectable (subject to the service type being suitable etc.) via the NorDig IRD service list. When set to ‘0’/’false’ this indicates that the IRD is not expected to offer the service to the user in normal navigation modes however the NorDig IRD should provide a mechanism to access these services (for example by direct entry of the logical channel number).

reserved: All “reserved” bits shall be set to ‘1’ (observe, however, that the IRD shall be able to handle (neglect) future use of reserved bits).

logic_channel_number: this is a 14-bit field which indicates the broadcaster preference for ordering services. It shall be working together with service_type. The logic channel number shall be grouped into three service type categories; TV, Radio and Others/data services as specified in 12.1.5. Each broadcaster shall, as far as possible, allocate unique logic_channel_number within his original_network for each service type category (TV, Radio and Others). The logic_channel_number use is defined in Table 12.12.

visible service flag	Logic channel number (decimal value)	Description
0	0	Service not suitable for selection by the user. For example, the value zero may be used for data services only intended for selection from interactive applications or for firmware download services etc.
1	0	Reserved for future use
0	1 – 16383	Reserved for future use
1	1 – 9999	Service displayed in service list and ESG. Accessible via P+/- keys or from numeric keys (same value as decimal value of logic_channel_number)
1	> 9999	Reserved for future use

Table 12.12 Logic_channel_number allocation (LCD v1)

12.2.9.2.2 Sorting of services inside a Channel list

All “visible” services shall be displayed in the service list(s), sorted according to logic_channel_number and be addressed with a number in the service list equal to the logic_channel_number, as far as possible. The NorDig IRD may have several default service lists (or sections inside one) for the different service_types, for example one for each service_type or typically three main categories; TV, Radio and Others (“Others” is not applicable for IRDs without API, see chapter: 14: NorDig Basic) If the IRD has several service_lists, the addressing of each service in each list shall match, as much as possible the logic_channel_number value (if no collision within a list).

Services shall first be ordered depending on their original_network_id, secondly to their service category, thirdly to their logic_channel_number and last on their service_type (independently of several services have collision in the logic_channel_number or if they are listed or not in the logic_channel_descriptor). I.e. first all services from one original network and within that original_network first all TV category services, after that all Radio category services and last all Other category services. After that original network any next original network that the IRD is able to receive and so on.

Services listed in the logic_channel_descriptor, shall have higher priority when ordering the services in the default service list, than services that are not listed. With other words, broadcast services may not be listed in any logic_channel_descriptor and these shall be displayed and accessible in the default service list, but be located last in the service list, in order to their service_type.

12.2.9.2.3 Conflict handling of Logic_channel_number (Informative)

If several services are allocated to the same logic_channel_number, (within the same channel list, as may be the case if several terrestrial regions can be received at the same location or several satellite networks are received), one service shall be ordered according to the logic_channel_number and the others shall be placed last in that list. Empty spaces in the broadcast logic channel numbering shall then not be used, instead they shall be located last, after the service with highest logic_channel_number of that service_type (The broadcaster may quite consciously choose to leave empty spaces in the logic channel numbering, for future services, etc, in order to avoid a complete rearrangement of the list). How to choose which service within same service type that should be placed according to the channel list is up to the IRD manufacturer.

12.2.9.2.4 Example of Logic_Channel_descriptor (LCD) (version 1)

The examples in Table 12.13 and Table 12.14 below illustrates how broadcasted services shall be ordered in the IRD's service lists according to (a terrestrial) broadcast.

ONID	TSID	SID	NID	VSF	LCN	Service type	Comment
100	10	100	101	1	10	0x01 (TV)	SD service that in SDT incl Linkage to NorDig Simulcast replacement service at SID 140
200	10	100	200	1	10	0x01 (TV)	other network provider
100	10	110	101	1	11	0x01 (TV)	
100	10	90	101	-	-	0x01 (TV)	no logic_channel_descr attached to this service
100	20	120	101	1	23	0x01 (TV)	
100	20	200	101	1	23	0x02 (Radio)	other type of service
100	20	120	102	1	23	0x01 (TV)	same service from other terrestrial region (and other transmitter point)
100	20	130	101	1	24	0x01 (TV)	
100	30	140	101	1	10	0x19 (HDTV)	HD Simulcast service
100	30	150	101	1	11	0x19 (HDTV)	HD service (no simulcast, only prio to LCN 11 due to its service_type)
100	10	500	101	0	0	0x0C (Data)	e.g. SSU/Bootloader or EPG service

Table 12.13 Example of broadcast of SI and services (LCD v1). The abbreviations are defined as: S_ID; service_ID, ON_ID; original_network_ID; TS_ID; transport_stream_ID, NID; network_ID, VSF; visible_service_flag, LCN; logic_channel_number.

Table 12.14 exemplifies how services shall be sorted and listed in the IRD's service list (from broadcast example above) in a NorDig IRD with at least two service_lists, one for TV and one for Radio services. Displayed for the viewer in each service list, will typically be the number (LCN) and the service_name.

NorDig IRD, service list installation example

TV service list					Radio service list				
Number	ONID	TSID	SID	NID	Number	ONID	TSID	SID	NID
10	100	30	140	101	23	100	20	200	101
11	100	30	150	101					
23	100	20	120	102					
24	100	20	130	101					
25	100	10	110	101					
26	100	10	90	101					
27	200	10	100	200					

Table 12.14 NorDig IRD service list example using LCD v1.

The service [ONID, TSID, SID] = 100, 20, 120 is listed only once (even though that service is transmitted twice). This due to that the IRD in this example above has a stronger and a better reception (quality) of the TS where service [ONID, TSID, SID, NID] = 100, 20, 120, 102 belongs to, than for the TS where the service [ONID, TSID, SID, NID] = 100, 20, 120, 101 belongs to.

12.2.9.3 NorDig private; Logical Channel Descriptor (version 2)

12.2.9.3.1 Syntax of LCD version 2

The syntax of the Logical Channel Descriptor (version 2) is shown in Table 12.15.

Syntax	No. of bits	Identifier
Logical_channel_descriptor(){		
descriptor_tag	8	Uimsbf
descriptor_length	8	Uimsbf
for (i=0;i<N;i++){		
channel_list_id	8	Uimsbf
channel_list_name_length	8	Uimsbf
for (i=0;i<N;i++) {		
char	8	Uimsbf
}		
country_code	24	Uimsbf
descriptor_length	8	Uimsbf
for (i=0;i<number_of_services;i++){		
service_id	16	Uimsbf
visible_service_flag	1	Bslbf
reserved_future_use	5	Bslbf
logical_channel_number	10	Uimsbf
}		
}		

Table 12.15 Logical_Channel_descriptor (version 2)

descriptor_tag: This shall be assigned to be 0x87 (decimal 135)

channel_list_id: This is an 8-bit field which serves as a label to identify the channel list (uniquely allocated within each original_network_id). The user should be able to select a preferred channel list to be used, when several are available during the first-time installation (or complete re-installation).

channel_list_name_length: This 8-bit field specifies the number of bytes that follow the channel_list_name_length field for describing characters of the name of the Channel List. Maximal length is 23 bytes for the channel_list_name.

char: This is an 8-bit field. A string of character fields specify the name of the channel list, the channel_list_name. (Maximal length is 23 bytes for the channel_list_name). Text information is coded using the character sets and methods described in EN 300 468, annex A. The IRD is recommended to use the channel_list_name to present information on the OSD, for example when the user chooses a preferred channel list among several to create the IRD's service list(s).

country_code: This 24-bit field identifies a country using the 3-character code as specified in ISO 3166 [49] . Each character is coded into 8-bits according to ISO 8859-1 [50] and inserted in order into the 24-bit field. In the case that the 3 characters represent a number in the range 900 to 999, then country_code specifies an ETSI defined group of countries. These allocations are found in ETSI ETR 162 [23].

EXAMPLE: Sweden has 3-character code "SWE", which is coded as:

'0101 0011 0101 0111 0100 0101'.

The IRD may use this field (in combination with the IRD's user preference settings) to propose a channel list to be chosen as preferred when several are available.

service_id: A service_id that belongs to the TS (i.e. services from other TS shall not be listed). One service may only be listed once in each channel list, but may belong to/be listed in more than one channel list.

visible_service_flag: This 1-bit field when set to ‘1’/’true’ indicates that the service is normally visible and selectable (subject to the service type being suitable etc.) via the NorDig IRD’s service list. When set to ‘0’/’false’ this indicates that the IRD is not expected to offer the service to the user in normal navigation modes however the NorDig IRD should provide a mechanism to access these services (for example by direct entry of the logical channel number).

Reserved: All “reserved” bits shall be set to ‘1’ (observe, however, that the IRD shall be able to handle (neglect) future use of reserved bits).

logic_channel_number: This is a 10-bit field which indicates the broadcaster preference for ordering services. It shall be working together with service_type. The logic channel number shall be grouped into three service type categories; TV, Radio and Others/data services as specified in section 12.1.5. Each broadcaster shall, as far as possible, allocate unique logic_channel_number within his original_network for each service type category (TV, Radio and Others). The logic_channel_number use is defined in Table 12.16.

Visible service flag	Logic channel number (decimal value)	Description
0	0	Service not suitable for selection by the user. For example, the value zero may be used for data services only intended for selection from interactive applications or for firmware download services etc.
1	0	Reserved for future use
0	1 – 1024	Reserved for future use
1	1 – 999	Service displayed in service list and ESG. Accessible via P+/- keys or from numeric keys (same value as decimal value of logic_channel_number)
1	> 999	Reserved for future use

Table 12.16 Logic_channel_number allocation

12.2.9.3.2 Handling of multiple Channel lists from same network

The Logical Channel Descriptor version 2 enables transmission within same network of multiple Channel lists, meaning that there might it be several channel lists available for a IRD to choose between. The NorDig IRD may treat each channel list as complete with all intended services for that network (original network id) and it is up to the broadcaster to ensure that all intended services are included in all lists.

The NorDig IRD shall at least store the sorting from one of the available Channel lists as default, but it is recommended that theNorDig IRD store all the transmitted Channel Lists sorting that matches the IRD’s country code settings (especially for IRDs that are not letting the user choose list during installation).

When several Channel Lists are available from same network (original network id) for the IRD during first time installation (or complete re-installation), the NorDig IRD shall choose the channel list as the default one with following priority:

1. The list with same country code as the IRD’s user preference setting’s country code. If several list available with same matching country code, the IRD shall choose the one with lowest list_id value OR let the viewer choose from a list, (typically using the channel_list_name)
2. If no Channel list has a country code that matches the user preference setting’s country code, theNorDig IRD shall let the viewer choose from a list (recommended) OR choose the one with lowest list_id value.

12.2.9.3.3 *Sorting of services inside a Channel list*

All “visible” services shall be displayed in the service list(s), sorted according to `logic_channel_number` and be addressed with a number in the service list equal to the `logic_channel_number`, as far as possible. The IRD may have several default service lists (or sections inside one) for the different service_types, for example one for each service_type or typically three main categories; TV, Radio and Others (“Others” is not applicable for IRDs without API). If the NorDig IRD has several service_lists, the addressing of each service in each list shall match, as much as possible the `logic_channel_number` value (if no collision within a list).

Services shall first be ordered depending on their `original_network_id`, secondly to their service category, thirdly to their `logic_channel_number` and last on their service_type (independently of several services have collision in the `logic_channel_number` or if they are listed or not in the `logic_channel_descriptor`). I.e. first all services from one original network and within that original_network first all TV category services, after that all Radio category services and last all Other category services. After that original network any next original network that the IRD is able to receive and so on.

Services listed in the `logic_channel_descriptor`, shall have higher priority when ordering the services in the default service list, than services that are not listed. With other words, broadcast services may not be listed in any `logic_channel_descriptor` and these shall be displayed and accessible in the default service list, but be located last in the service list, in order to their service_type.

12.2.9.3.4 *Conflict handling of Logical_channel_number*

If several services are allocated to the same `logical_channel_number`, (within the same channel list, as may be the case if several terrestrial regions can be received at the same location), one service shall be ordered according to the `logical_channel_number` and the others shall be placed last in that list.

Empty spaces in the broadcast logic channel numbering shall then not be used; instead they shall be located last, after the service with highest logic channel number of that service_type. (The broadcaster may quite consciously choose to leave empty spaces in the logic channel numbering, for future services, etc, in order to avoid a complete rearrangement of the list).

Whenever two or more services within same category are allocated to the same `logical_channel_number`, the HD IRD shall priorities the advanced codec services as following for TV category; first 0x19 adv codec HDTV service, secondly 0x16 adv codec SDTV service and last 0x01 (MPEG-2 SD) TV service and for radio category; first 0x0A adv codec radio and secondly 0x02 radio service types.

How to choose which service within same service type and same service priority that should be placed according to the channel list is up to the IRD manufacturer.

12.2.9.3.5 *Example of Logic_Channel_descriptor (LCD) (version 2)*

Table 12.17 below illustrates how broadcast services shall be ordered in the NorDig IRD’s service lists, by use of LCD Version 2; with an example from a terrestrial broadcast.

CLID	ONID	TSID	SID	NID	VSF	LCN	Service type	Comment
1	100	10	100	101	1	10	0x01 (TV)	SD service that in SDT incl Linkage to NorDig
1	200	10	100	200	1	10	0x01 (TV)	Simulcast replacement service at SID 140 other network provider and other combination channel_list_id, ONID
1	100	10	110	101	1	11	0x01 (TV)	no logic_channel_descr attached to this service
-	100	10	90	101	-	-	0x01 (TV)	
1	100	20	120	101	1	23	0x01 (TV)	other type of service same service from other terrestrial region (and other transmitter point)
1	100	20	200	101	1	23	0x02 (Radio)	
1	100	20	120	102	1	23	0x01 (TV)	
1	100	20	130	101	1	24	0x01 (TV)	HD Simulcast service Same service listed in a other channel list
1	100	30	140	101	1	10	0x19 (HDTV)	
2	100	10	100	101	0	0	0x01 (TV)	
1	100	30	150	101	1	11	0x19 (HDTV)	HD service (no simulcast, only prio to LCN 11 due to its service_type)
1	100	10	500	101	0	0	0x0C (Data)	e.g. SSU/Bootloader or EPG service

Table 12.17 Example of broadcast of SI and services, LCN Version 2. The abbreviations are defined as: CL_ID; Channel_list_ID, ON_ID; original_network_ID; TS_ID; transport_stream_ID, NID; network_ID, S_ID; service_ID, VSF; visible_service_flag, LCN; logic_channel_number.

Table 12.18 exemplifies how services shall be sorted and listed in the IRD's service list (from broadcast example above) in a NorDig IRD with at least two service_lists, one for TV and one for Radio services and here with the channel list CLID 1 (country code match) and ONID 100 as the chosen preferred channel list. Displayed for the viewer in each service list, will typically be the number (LCN) and the service_name.

NorDig IRD, service list installation example

TV service list					Radio service list				
Number	ONID	TSID	SID	NID	Number	ONID	TSID	SID	NID
10	100	30	140	101	23	100	20	200	101
11	100	30	150	101					
23	100	20	120	102					
24	100	20	130	101					
25	100	10	110	101					
26	100	10	90	101					
27	200	10	100	200					

Table 12.18 NorDig IRD service list example using LCD v2.

The service [ONID, TSID, SID] = 100, 20, 120 is listed only once (even though that service is transmitted twice). This due to that the IRD in this example above has a stronger and a better reception (quality) of the TS where service [ONID, TSID, SID, NID] = 100, 20, 120, 102 belongs to, than for the TS where the service [ONID, TSID, SID, NID] = 100, 20, 120, 101 belongs to.

12.2.9.4 NorDig LCD simultaneous version 1 and version 2 transmissions

When broadcasting both LCD version 1 and version 2 within one Original Network ID, the NorDig IRD supporting both descriptors shall only sort according to the version 2 (i.e. NorDig LCD version 2 has higher priority).

12.2.9.5 Reception of multiple (DTT) networks and NorDig LCD

Comment: There are several areas within the Nordic region where DTT networks from the neighbouring countries can be received (for example southern part of Sweden, where Danish and German DTT can be received). Below follows a clarification to the use of the NorDig logical channel descriptor (LCD), regarding reception from multiple DTT networks

The NorDig IRD with terrestrial front-end shall be able to install several (DTT) original networks (with different original network ids).

For multiple original networks (original network ids) the NorDig IRD shall first sort/list all services from one original network (original network id) according to that LCD, before sorting/listing the next original network. The first original network is the primary network and any additional received original networks are referred to as secondary network(s).

The user shall be able to set which original network that shall be the primary, either via the user preferences, e.g. matching country setting (preferred) or via user selectable list of available original networks or similar mechanism. In order to simplify this, the NorDig IRD should map/translate the original network id into the country name. This means that for IRD where the user has set the country setting, the primary network should automatic be the country matching the original network id (and its services shall be listed first in the NorDig IRD's service list).

(Automatic) updates within the NorDig IRD shall not change within the IRD's service list the relative order between the installed primary network and secondary network(s).

For IRDs with terrestrial front-end, intended for the Nordic area it is recommended to include a translation list of all Northern Europe DTT original network ids. For original networks transmitting LCD version 2, the country code will be found directly within the descriptor without any mapping.

The primary DTT network shall be listed according to its LCD (version 2 or version 1), then additional (secondary) network(s) shall be listed, one-by-one, with its services after the primary network's last listed services (i.e. not use empty logical numbers within first network). This means that the services from the additional DTT network(s) will not be listed according to its LCN values. Important is to only include visible marked services from additional (secondary) networks and not any service that is marked as non-visible. It is recommended - if possible- to keep the relative order between the listed services within any secondary network(s).

If the IRD manufacture chose to have multiple service lists, (one for each original network id or similar), then the primary network shall be the IRD's default service list after the installation.

Note: Within DVB's SI code allocation (ETRI62), there is normally an un-written code of practise for digital terrestrial networks that the original network id has been allocated by the DVB office to the value of 0x2000 plus the country's ISO 3166 Country code value. This is true for almost all countries, but not for e.g. the Swedish DTT, which has original network id value (0x22F1).

12.2.9.6 Guidelines of number of services to be handled (Informative)

It is recommended that NorDig IRD with terrestrial front-end are able to handle up to 400 services identities during installation mode and 200 services. It is recommended that NorDig IRD with satellite, cable and IP front-end are able to handle up to 600 services identities during installation mode and 400 services afterwards. (More services are recommended during installation mode due to the possibilities to receive from several transmitter sites and use of multiple Channel lists).

12.3 Service Description Table (SDT)

12.3.1 The Service Descriptor Table Descriptors

SDT descriptors
Metadata_pointer_descriptor (2)
Service_descriptor
CA_identifier_descriptor
Linkage_descriptor
Service_identifier_descriptor
Default_authority_descriptor (2)
CI_protection_descriptor (3)

Table 12.19 SDT descriptors

Note 1: NorDig IRDs with IP-based front-end: SDT is only used for actual transport stream (table_id = 0x42).

Note 2: NorDig PVR only.

Note 3: Mandatory for IRDs that support use of CIP-CAMs, see section 9.2

12.3.1.1 Metadata Pointer Descriptor (NorDig PVR only, Broadcast Record Lists)

This metadata pointer descriptor is applicable for IRD supporting NorDig Broadcast record Lists.

For metadata pointer descriptor that is delivered in the SDT, refers that the metadata (NorDig Broadcast record Lists) is valid for that service(s) and will be placed in the descriptor loop of all services for which this metadata service is relevant.

For the rest see NorDig chapter 12.2.2 (including the metadata pointer extension).

12.3.2 Service Descriptor

The service_type (under the service_descriptor) value 0x81 is reserved for the NorDig legacy bootloader use (see section 12.2.9.2).

12.3.3 CA Identifier Descriptor

This descriptor may be present in the SDT when at least one service component is scrambled. The CA_system_id is allocated by ETSI and is given by ETSI ETR 162 [23]. The descriptor may be used statically (recommended). It will in that case be set according to the services regular/normal scrambling status. Alternatively it may be used dynamically, in accordance with the current services scrambling status.

This static use enables IRDs to “grey mark” services that cannot be descrambled due to lack of the required CA-system for the relevant service(s). It allows the IRD to display services that are only temporary (event based) scrambled.

12.3.4 Linkage Descriptor

The following linkage_type value shall be interpreted by a NorDig IRD when used inside the SDT:

- 0x05, linkage to a service replacement service. When present, the NorDig IRD should automatically switch to the replacement service if the ‘running_status’ is set to “1” (not running) and if the NorDig IRD are able to receive the SDT containing the original service during the replacement, also switch back when ‘running_status’ is set to “4” (running).
- 0x82, NorDig Simulcast replacement service, linkage from an (MPEG2) SDTV based service to an (MPEG4 AVC) HDTV replacement service with the same content. It may be used during simulcasting of a service in both an SDTV and an HDTV version on separate service ids with same content within

the same original network id. This linkage may be included in the (MPEG2) SDTV service (service_type 0x01) within the SDT pointing to the HDTV version (service_type 0x19) of the service. Whenever it is used, it will be used quasi-static.

- When an SDTV service includes this NorDig simulcast replacement service linkage (0x82) pointing to the HDTV version of the service, the NorDig IRDs shall only include the HDTV version/(service) of the two services within its TV service list. The SDTV may be omitted or hidden at the end of the list, dependant of IRD implementation.
- Clarification: If no ‘NorDig Simulcast replacement service’ linkage is included, both services shall be included. If only the (MPEG-2) SDTV version (service_type 0x01) is possible to receive (due to e.g. reception problems/limitations), the (HDTV) IRD shall include this service even if it carries a linkage ‘NorDig simulcast replacement service’.

12.3.5 Default authority descriptor (in SDT) (NorDig PVR only)

The default authority descriptor, defined in DVB document Carriage and signalling of TV-Anytime (TVA) information ETSI TS 102 323 [34], may be used to shorten the CRIDs carried within EIT by defining an appropriate CRID authority over a defined scope.

The DAD may be used in the descriptor loop of each service in the SDT to set a Default Authority for all events in that service which do not have a complete URL (see example in chapter 12.2.8 Default authority descriptor in NIT).

The prefix “crid://” may be omitted from the start of the text string in the Default Authority in the SDT (normally the “crid://” will be omitted within the transmission). See separate chapter for CRID usage in section 12.4.6.

12.4 Event Information Table

12.4.1 General

The NorDig IRD shall support EIT present/following (p/f) for both actual and other tables (1).

The NorDig IRD shall support EIT schedule (sch) for both actual and other tables (1) up to at least 8 days of schedules.

Note 1: DVB SI ‘Other’ tables are optional/not applicable for NorDig IRDs with IP-based Front-end.

12.4.2 The Event Information Table Descriptors

Event descriptors	EIT p/f	EIT sch
short_event_descriptor	M	M (1)
Component_descriptor	M	M (1)
Extended_event_descriptor	M	O
Content_descriptor	M	M (1)
Parental_rating_descriptor	M	M (1)
CA_identifier_descriptor (optional)	O	O
Content_identifier_descriptor	M (2)	M (2)

Table 12.20 EIT p/f descriptors

Note 1: EIT schedule is recommended (optional) and for NorDig IRDs with IP-based Front-end and for NorDig Basic without PVR that are launched before July 2011.

Note 2: NorDig PVR only.

12.4.3 CA Identifier Descriptor

This descriptor is optional, however, it may be present in the EIT whenever at least one service component is scrambled. The CA_system_id is allocated by ETSI and is given by ETSI ETR 162 [23].

When used, it will be used dynamically, i.e. following the services scrambling status, mainly targeting the ESG/EPG applications.

12.4.4 Content Descriptor

The NorDig IRD should handle all content nibbles listed in the DVB SI specification (ETSI EN 300 468 [15]), but shall at least be able to handle all content nibble level 1 classes. If there is no content coding in conformance with table present for an event, the default content description "unclassified" shall be assumed by the receiver.

12.4.5 Content Identifier Descriptor (NorDig PVR only)

The Content Identifier Descriptor (CID), defined in DVB document Carriage and signalling of TV-Anytime (TVA) information ETSI TS 102 323 [34], section 12.1, is used to associate a CRID to an event and is placed within the event loop of EIT. One or more instances of the descriptor may be present in the EIT (schedule and p/f) and a single descriptor may contain multiple CRIDs. Usage shall be consistent between EIT schedule actual and other within a Network. If a Content Identifier Descriptor is present in EITp/f, a NorDig PVR should use this in preference to the Content Identifier Descriptor for the same event in EIT schedule.

NorDig uses TV Anytime standard values for the `crid_type`, which are:

- 0x01, TVA programme CRID
- 0x02, TVA series CRID
- 0x03, TVA recommendation CRID

Only a single TVA programme CRID (`crid_type` 0x01) shall be associated with an EIT event.

The Content Identifier Table is not used in NorDig networks, (i.e. only `crid_location` == '00' is used).

All events having the same programme CRID (type 0x01), regardless of IMI (see ETSI TS 102 822-4 [36], Section 10), refer to the same programme content.

All events having the same series CRID (type 0x02) belong to the same series. An event may be associated with more than one series CRID. A CRID value may be reused after 91 days for other content.

12.4.6 CRID encoding and reuse (NorDig PVR only)

The CRID shall be according to ETSI TS 102 822-4 [36], Section 8. The use of abbreviated CRIDs shall follow the rules set out in ETSI TS 102 323 [34] Section 6.3.1.

The NorDig PVR shall support CRIDs that is encoded according to the following rules:

- The CRID is further restricted to only contain characters encoded over the range from ISO 6937 0x20 to 0x7F.

The length of the CRID plus IMI (if any) shall not exceed 64 characters as a combined total for the `crid`'s authority, data and instance metadata identifier (including the separator '#').

The CRIDs are not intended to be human readable and shall not be displayed on-screen. The CRID is simply an identifier.

The authority part of a CRID shall be a registered internet domain name and therefore globally unique. The data part of a CRID is only unique within the scope of the associated CRID authority. An IMI is only unique within the scope of the complete CRID.

Broadcasters shall endeavour to use the same CRID whenever a programme is repeated. However, this cannot be guaranteed. A repeat of any content by a different service provider may result in a different CRID being assigned.

CRIDs and IMIs may be reused to refer to different programme concepts with the following restrictions:

Series CRIDs shall not be re-used for 91 days after the scheduled end-time of the last event that referenced this CRID.

Programme CRIDs shall “never” be reused for different programme content, (i.e. Broadcasters shall do their outmost to keep the CRID unique for all time).

IMI shall not be reused for a different instance of the same CRID within 3 hours of the scheduled end time (start_time plus duration). Two events greater than or equal to 3 hours apart but with the same CRID & IMI shall not be considered to be split parts of the same instance.

12.4.6.1 CRID type 0x01 – programme CRID (NorDig PVR only)

Programme CRIDs are used to identify two or more EIT events as being the same programme. This prevents duplicate programmes being recorded from within the same series and also allows alternative programme instances to be recorded (or offered for recording) if a booking clash occurs.

It is not necessary for all EIT events to have a programme CRID. An event may only include a maximum of one programme CRID. In the current context they are only useful where alternative instances or split programmes are being identified.

12.4.6.2 CRID type 0x02 – series CRID (NorDig PVR only)

Where a series CRID is conveyed in a CID according to the signalling outlined, it is to be used to only refer to an editorial concept of a series.

An event may be associated with more than one series, i.e. an event may include several series CRIDs. Where an event is associated with more than one series, an invitation to record ‘programmes in the same series as this event’ would book to record all events in all series associated with the selected event (see more section 14.3.3).

12.4.6.3 CRID type 0x03 – recommendation CRID (NorDig PVR only)

This identifies a looser linkage to another programme or series. A recommendation may point to a single event (programme CRID) or a series (series CRID).

A CRID in the CID shall be marked as crid type 0x03 (recommendation) and be a programme or series CRID.

It is not required that the recommendation CRID be present in the current scope of EIT. If the event referenced by the recommendation CRID is not present in the current scope of EIT, the recommendation may be presented to the user when it appears in EIT. If a recommendation CRID does not appear in EIT within 91 days of the referencing event it shall be discarded.

A recommendation may reference an event earlier in the EIT schedule than the linked-from event, e.g. to link to a preview programme.

12.4.6.4 Split programme (split content) (NorDig PVR only)

A programme may consist of multiple EIT events within the same service or over several services. For example, a film might be divided into two parts (blocks) interrupted by a news programme in the middle or a longer sport event might be split into several parts over several services.

To be able to signal a split content programme the events shall include a CRID in the Content Identifier Descriptor (CID) that includes a programme CRID (crid type 0x01) with an Instance Metadata Identifier (IMI) extension. A “split programme” is defined as several events which have the same programme CRID and IMI value and the gap between each event is less than 3 hours (measured from the end of the preceding event to the start of the next event). Such events shall be considered to be segments of a single item of content. An item of content may be split across more than two events as long as the gap between each event remains less than 3 hours.

Where a broadcaster changes a single programme into a split programme (using IMIs) the broadcaster should ensure that one of the events of the new split programme maintains the event_id of the original single event. Failure to do this will result in lost or incomplete recordings.

12.4.7 Event Information Table Schedule

Upon user request for EIT schedule information, the IRD shall (1) look for the reference using linkage descriptor mechanism in the NIT and perform a frequency re-tuning if necessary. Linkage_type 0x04 (“Transport Stream containing complete network/bouquet SI”) shall be used to refer to EIT schedule information.

Note 1: Recommended for NorDig Basic

12.5 Time and Date Table and Time Offset Table

The NorDig IRD shall have a real time clock and time/date (calendar) running continuously. The time/date (calendar) shall be updated by incoming TDT and TOT from SI. NorDig IRD shall display the correct time for each country based on TDT, TOT, and the country name selected by the user.

NorDig IRDs with an IP-based front-end shall be able to establish real time and date (calendar) by any of the following methods:

1. Updates by incoming TDT and TOT from the SI.
2. Retrieval from the IP-network, based on RFC 1305 (Network Time Protocol (Version 3)). The address of the NTP server shall be retrieved from the Network Time Server DHCP option (42).

Note: This protocol may be used for Network time services for the transport stream with accuracy better than 50 ms.

3. Retrieval from the IP-network, based on RFC 2030 (Simple Network Time Protocol (SNTP) Version 4 for IPv4, IPv6 and OSI). The address of the SNTP server shall be retrieved from the Time Server DHCP option (3).

Note: This protocol may be used for Network time services for applications with an accuracy of 100 ms.

The NorDig IP IRD shall prefer the TDT/TOT, followed by the NTP protocol, in case no TDT/TOT is available in the stream. In case neither TDT/TOT nor a NTP server is available, the IRD shall retrieve time and date from the SNTP server.

In order to support offset from UTC time when using NTP or SNTP servers, the IRD shall support the DHCP Time Offset option (option number 2), specified in RFC 2132, IETF RFC 2132 [47].

The NorDig IRD should have an internal timer for the possibility to automatically switch from stand by mode to the operational mode. This timer shall (1) be initiated locally (accepted by the end user).

Note 1: During this kind of start up or during any pre-programmed zapping, it is advisable that the NorDig IRD does not try to start anything that requires user acknowledgement or similar, for example updating of service list data or bootloader software.

12.5.1 Time Offset Table Descriptor

Time Offset Table
local_time_offset_descriptor

Table 12.21 TOT descriptors

12.6 Conditional Access and Program Map Tables

12.6.1 Conditional Access Table Descriptors

Conditional Access Table
CA_descriptor

Table 12.22 CAT descriptors

12.6.2 Program Map Table Descriptors

Program map Table
metadata_descriptor (3)
teletext_descriptor
Subtitling_descriptor
stream_identifier_descriptor
video_stream_descriptor
CA_descriptor
ISO_639_language_descriptor
AC-3 descriptor
Enhanced_AC-3_descriptor
AAC_descriptor
Supplementary_audio_descriptor
Private_data_specifier_descriptor
data_broadcast_id_descriptor (1)
application_signalling_descriptor (2)
carousel_id_descriptor (1)
(NorDig) Content_Protection_descriptor
related_content_descriptor (3)

Table 12.23 PMT descriptors

Note 1: Use of the data_broadcast_id_descriptor and the carousel_identifier_descriptor for signaling relevant for the SSU is specified in ref ETSI TS 102 006 [31], see also section 12.7

Note 2: This descriptor is only mandatory for the MHbbTV-based receivers (i.e. Hybrid Profile)

Note 3: NorDig PVR only.

12.6.3 Component priority multiple video or audio streams

Component priority when multiple video or audio streams are received

The following applies for services that transmit in parallel more than one type of video/audio stream under the same service_id (e.g. simulcasting within the same service):

For video decoding, NorDig IRDs shall select the service's video component, and set the default setting in accordance with the priority list in Table 12.24.

Video codec	Stream_type	Priority
MPEG-4 AVC HP@L4 HD video stream	0x1B	1 (highest)
MPEG-4 AVC HP@L4 / L3 SD video stream	0x1B	2
Basic, MPEG-2 MP@ML video stream (or MPEG1)	0x02 (0x01)	3 (lowest)

Table 12.24 Default priority order for the IRD between different video streams

For Audio decoding, NorDig IRDs shall prioritise the service's components according to chapter 6.5, Audio prioritising.

NorDig IRDs shall ignore advanced audio streams when it does not support such decoding those streams. For example, an IRD that do not include any AC-3 (down-mix) decoder, (maybe only supports pass-

through of AC-3 to the digital audio output), shall not choose the AC-3 audio stream as default. Instead it shall choose among the IRDs supported audio stream types according to chapter 6.5, Audio prioritising.

When several streams of the same type are received, the primary stream shall be selected in accordance with the definitions in section 6.5 (Audio Prioritising).

Note 1: Some typical dynamic changes in audio streams are listed in section 6.9.

Note 2: Hard of hearing audio stream is defined in ISO639_language_descriptor in [51].

12.6.4 ISO 639 language descriptor

The NorDig IRD shall use the ISO 639 descriptor to select the preferred audio stream according to user preference settings, see section 6.5 Audio Prioritising. Observe that other audio descriptors have priority compared to this as stated in section 6.5.4. The descriptor will at least be used when a services contains more than one audio stream of same codec. (Used for all NorDig audio codecs streams, ie MPEG-1 Layer II, HE-AAC, AC-3 and E-AC-3 audio streams).

The NorDig IRD shall use the field 'audio type' to select the preferred audio stream. The NorDig IRD shall minimum support audio types: 0x00 'undefined' (referred here to as "normal") and 0x03 'visual impaired' (note 1) audio.

To avoid issues in legacy IRDs, language code 'nar' may be used for some supplementary audio streams (audio description etc), ('nar' is a non-allocated code in ISO639 Part 2, intended here to represent "narrative"). Some networks may even use European language that is not used in that country, e.g. in Finland the language Dutch may be used for the supplementary audio streams in some networks. Due to legacy IRDs, audio type 0x00 'undefined' may be used for some Supplementary Audio streams. See section 6.11 for further information about Supplementary Audio.

The NorDig IRD shall minimum support language codes as stated in section 12.1.8.

12.6.5 AC-3 descriptor

The NorDig IRD supporting AC-3 shall use the AC-3 descriptor ('Number of channels flags' value) when selecting appropriate audio format (stereo or multichannel), when several audio streams is available for the service, as described in section 6.5.4 Signalling to be used for audio property.

For AC-3 audio streams with no supplementary audio descriptor but the 'service type flags' set to Visually Impaired (VI) in the AC-3 descriptor, this shall be the trigger for the NorDig IRD that the audio stream is a broadcast mixed Supplementary Audio.

Note: AC-3 is not suitable for receiver mixed Supplementary Audio and NorDig IRDs are not required to support this.

12.6.6 Enhanced AC-3 descriptor

The NorDig IRD supporting E-AC-3 shall use the Enhanced AC-3 descriptor ('Number of channels flags' value) when selecting appropriate audio format (stereo or multichannel), when several audio streams is available for the service, as described in section 6.5.4 Signalling to be used for audio property.

For E-AC-3 audio streams with no supplementary audio descriptor but the 'service type flags' set to Visually Impaired (VI) in the Enhanced AC-3 descriptor, this shall be the trigger for the NorDig IRD that the audio stream is a Supplementary Audio. In this case the NorDig IRD shall use the 'full service flag' to determine whether the stream is broadcast mixed audio (value '1') or if it is a receiver mixed audio (value '0').

12.6.7 AAC descriptor

The NorDig IRD supporting HE-AAC shall use the AAC descriptor ('audio type' value) when selecting appropriate audio format (stereo or multichannel), when several audio streams is available for the service, as described in section 6.5.4 Signalling to be used for audio property.

The broadcaster may typically signalize the maximum 'profile and level' and 'AAC type' that the audio stream may have in transmission. An audio stream that is signalized as multichannel may for certain periods only be a stereo channel audio stream.

The NorDig IRD supporting HE-AAC shall support profile and level values stated in Table 12.25 below

profile and level value	Description	NorDig comment
0x51	LC-AAC Level 2	no SBR used, up to stereo (mono or stereo)
0x52	LC-AAC Level 4	no SBR used, up to 5.1 (e.g. mono, stereo, 5.1)
0x58	HE-AAC Level 2	SBR may be used, up to stereo
0x5A	HE-AAC Level 4	SBR may be used , up to 5.1(e.g. mono, stereo, 5.1)

Table 12.25 AAC descriptor's Profile and level values for NorDig IRDs

The NorDig IRD supporting HE-AAC shall minimum support AAC types stated in Table 12.26 below.

AAC type value	Description	NorDig comment
0x01	HE-AAC audio, single mono channel	trigger for normal (mono) audio
0x03	HE-AAC audio, stereo	trigger for normal (stereo) audio
0x05	HE-AAC audio, surround sound	trigger for normal (multichannel) audio
0x42	HE-AAC Receiver mixed Supplementary Audio as per annex E of TS 101 154	If no supplementary audio descriptor is included then this shall be trigger for receiver mixed Supplementary Audio and this audio stream may include any AD_descriptor in PES_private_data for pan and fade control.
0x47	HE-AAC receiver mix audio description for the visually impaired	If no supplementary audio descriptor is included then this shall be trigger for receiver mixed Supplementary Audio and this audio stream may will <u>not</u> include any AD_descriotr in PES_private_data.
0x48	HE-AAC broadcaster mix audio description for the visually impaired	If no supplementary audio descriptor is included then this shall be trigger for broadcast pre-mixed Supplementary Audio

Table 12.26 AAC descriptor's AAC type values for NorDig IRDs.

As stated in section 6.5.4.3, for AAC audio streams without AAC descriptors shall be assumed to be of AAC type 0x03 (level 2, "normal" stereo).

The AAC descriptor shall have priority to any MPEG-4 audio descriptor.

12.6.8 Supplementary_audio_descriptor

The NorDig IRD shall support the supplementary audio descriptor for both types of Supplementary Audio streams (i.e. Broadcast mixed and Receiver mixed).

The NorDig IRD shall for the supplementary audio descriptor minimum support the combinations of *mix type* and *editorial classification* as listed in Table 12.27 below.

Audio type	Audio purpose	Mix type	editorial_classification
“normal”	Main audio	1	0
SA broadcast mixed	Audio description	1	1
SA receiver mixed	Audio description	0	1
SA broadcast mixed	Spoken Subtitles	1	3
SA receiver mixed	Spoken Subtitles	0 (note 1)	3 (note 1)

Table 12.27 Minimum combinations of the supplementary audio descriptor for the NorDig IRD. SA refers to Supplementary Audio.

The supplementary audio descriptor may also be used for the “normal” audio streams, the IRD has to parse the descriptor to determine the audio type.

Note 1: Up to some version of the ETSI EN 300 468 (v1.13.1) it has been missed to include the important combination mix_type ‘0’ with editorial classification ‘3’ (referring to receiver mixed spoken subtitles) and mentions that this is invalid and may not be used. NorDig however overwrite this and make this combination valid and shall be supported by the NorDig IRDs.

12.6.9 Metadata descriptor (NorDig PVR only, Broadcast Record Lists)

This metadata descriptor (as described in ISO/IEC 13818-1 [52]) is applicable for IRD supporting NorDig Broadcast record Lists.

Located in PMT ES descriptor loop the metadata descriptor which relates to the carousel carrying the NorDig BRL metadata service.

The metadata descriptor (PMT) and the metadata pointer descriptor (NIT/SDT) for the NorDig BRL will have matching values.

The metadata descriptor for NorDig BRL will also include metadata descriptor extension and Default Group Authority Structure as described in NorDig chapter 12.2.2.

The value of the fields in the metadata descriptor will be set as following signifying the metadata contained conforms to the NorDig BRL:

Metadata pointer descriptor fields	Value	Remark
metadata_application_format	0x0100	Matching value set in metadata_pointer_descriptor. NorDig uses TV Anytime and DVB standard value 0x0100, (while DTG uses value 0x0101)
metadata_format	0x3F	Matching value set in metadata_pointer_descriptor
metadata_service_id		Matching value set in metadata_pointer_descriptor
decoder_config_flags	0b000	Referring to that no configuration is required
DSCM-CC_flag	0x1	Referring to that the metadata is delivered in a carousel
service_identification_record		shall carry the path to the metadata in the carousel to which this descriptor refers. This path follows the convention set out in TS 102 323 [34] clause 5.3.4.2.

The metadata descriptor will include Metadata Descriptors Extention in accordance with DVB/ETSI TS 102 323[34], as described in NorDig section 12.2.2.1.

12.6.10 Content_Protection_descriptor

This descriptor is used to signal the content protection level for the received service, see Table 12.29.

The IRD shall use the signalled Content Protection level together with the IRD’s HDCP user setting to determine if HDCP shall be enabled or disabled on the HDMI output interface, see section 8.6.4.

The Content Protection descriptor shall be conveyed in the descriptor loop immediately following the program_info_length field in the Program Map Table. The descriptor only applies to the service to which the program map table is applicable. If the descriptor is missing for a service, it shall be interpreted as content protection level 0x01 (see Table 12.29).

Syntax	Number of bits	Identifier
Content_Protection_descriptor(){		
descriptor_tag	8	uimsbf
descriptor_length	8	uimsbf
Content_Protection_level	8	uimsbf
}		

Table 12.28 Semantics for the Content_Protection_descriptor

descriptor_tag: The descriptor tag is an 8-bit field which identifies the descriptor. The value for the Content_Protection_descriptor is 0xA0 (decimal 160, i.e. within the “user defined” range).

descriptor_length: The descriptor length is an 8-bit field specifying the total number of bytes of the data portion of the descriptor following the byte defining the value of this field. The value is always 0x01 for the Content_Protection_descriptor.

Content_Protection_level: The descriptor length is 8-bits, and represents the level of Content Protection required for a program/service. The currently defined levels and their interpretation are defined in Table 12.29:

Content Protection level	Description
0x00	Outputs shall <u>not</u> be protected. Any protection mechanism, such as HDCP, shall be switched off, regardless of video format and resolution
0x01* *) <i>Default value if no signalling</i>	Content protection is not required. The IRD's content protection mechanism may be set to ON or OFF, regardless of video format and resolution.
0x02	Content protection is mandatory for video with higher resolution than 576 horizontal lines, but not for resolutions with 576 or less lines. The IRD's content protection mechanism shall be set to ON for video with higher resolution than 576 horizontal lines, and may be set to ON or OFF for video with resolution lower than or equal to than 576 horizontal lines.
0x03	Content protection is mandatory regardless of video format and resolution. The IRD's content protection mechanism shall be set to ON.
<p>Note: Additional levels may be defined in the future. If the IRD receives other values for the Content Protection level than defined in Table 12.29, it shall neglect all bits except the last two and use these bits for interpreting the Content Protection level.</p> <p>The IRD shall in addition to the information provided in the Content_Protection_descriptor also use Content Protection information provided via the Conditional Access system when determining the required content protection, see section 8.6.4</p>	

Table 12.29 Specified content protection levels

IRD actions for the various required Content Protection levels, as depending on the HDCP user setting, are specified in section 8.6.4 (Table 8.2).

12.6.11 Related Content Descriptor (NorDig PVR only)

The NorDig PVR that supports Trailer booking (see 14.3.10), shall be able to handle the related content descriptor (as specified in ETSI TS 102 323 [34]). The RCT is signalled in the service's PMT dynamically. The related content descriptor will typically only be referenced in the PMT as long as RCT is available.

12.7 SSU UNT Descriptors

12.7.1 Descriptor Overview

This section specifies the mandatory and optional descriptors for support of the SSU Enhanced profile in NorDig IRDs.

Descriptor (tag value)	Tag value	Present in loop		
		Common	Target	Operational
scheduling descriptor	0x01			Ob Mr
Update_descriptor	0x02			Ob Mr
ssu_location_descriptor	0x03			Mb Mr
Message_descriptor	0x04			Ob Mr
Ssu_event_name_descriptor	0x05			Ob Or
target_smartcard_descriptor	0x06		Ob Or	
Target_MAC_address_descriptor	0x07		Ob Or	
target_serial_number_descriptor	0x08		Ob Or	
Target_IP_address_descriptor	0x09		Ob Or	

Target_IPv6_address_descriptor	0x0A		Ob Or	
Ssu_subgroup_association_descriptor	0x0B			Ob Mr
Telephone_descriptor	0x57			Ob Or
Private_data_specifier_descriptor	0x5F		Ob Or	Ob Mr
User private	0x80 to 0xFE			
Mb Mandatory to Broadcast, always/all time				
Ob Optional to broadcast, but recommended (if applicable)				
Mr Mandatory to receive and interpret if broadcast				
Or Optional to receive and interpret (if broadcasted)				

Table 12.30 Overview of SSU UNT descriptors to be supported by a NorDig IRD

12.7.2 Scheduling descriptor

The scheduling descriptor shall be according to [30]. The receiver shall hence support the periodicity parameters of the scheduling descriptor.

12.7.3 Update_descriptor

The update_descriptor shall be fully supported as specified in ref [30].

12.7.4 SSU_location descriptor

The association between the data carousel and the UNT shall be found using the association_tag of the ssu_location_descriptor in the UNT and the component_tag of the stream_identifier_descriptor in the PMT.

12.7.5 SSU_subgroup_association_table

The subgroup update_descriptor shall be supported as specified in [30].

12.7.6 private_data_specifier_descriptor

The private_data_specifier_descriptor shall be supported as specified in [30].

12.7.7 target_smartcard_descriptor

12.7.7.1 General

This section specifies the NorDig extensions to the target_smartcard descriptor, see also ref ETSI TS 102 006 [30]. The following rules shall apply:

- If a target smartcard descriptor is not present in the SSU stream, all individual IRDs for the given IRD model shall be updated (as for SSU simple profile).
- If a target smartcard descriptor is present in the SSU stream, the IRD shall react on an SSU request only if it is explicitly targeted in the data field of any of the targeting descriptors. This means that if a targeting descriptor without private data bytes is received, no IRDs shall be updated.
- If multiple target descriptors are present, the IRD shall trigger on the SSU as long as the condition given in at least one target descriptor are met.

12.7.7.2 NorDig smart card private data byte definition

The serial numbers will be represented either as a list of individual smart card numbers or (a) range(s) of smart card numbers.

A smart card number descriptor shall contain only one of the targeting modes defined below. If both modes are used, they shall be sent in separate target_smart_card_descriptors.

- **List mode= '0x01'** as the first byte in the private_data_byte defines a list of smart card numbers
- **Range mode= '0x02'** as the first byte in the private_data_byte define one or multiple ranges of smart card numbers.

- **0x03-0x1F reserved for future use**
- **0x20-0x50 to be defined by user of the SSU**

12.7.7.2.1 *Format of the list mode*

Format of the list mode shall be:

01 <smartcard number #1> < smartcard number #2> < smartcard number#3> ...< smartcard number #n>

Example (targeting of 3 smart card numbers, 8 bytes each)

Serial number 1: 1127154194 (dec)

Serial number 2: 1127154196 (dec)

Serial number 1: 1127154197 (dec)

Will be signaled as:

01 00 00 00 00 43 2F 02 12 00 00 00 00 43 2F 02 14 00 00 00 00 43 2F 02 15 (hex)

The first byte (0x01) indicates that a list of smartcard numbers will follow. The next 8 bytes represent the first smartcard number, the next 8 bytes the next and so on.

12.7.7.2.2 *Format of the range mode*

It is possible to insert multiple ranges of smart card numbers in the range mode:

Format of the range mode shall be:

**02 <start smartcard number range#1><stop smartcard number range#1>.....
<start smartcard number range#n><stop smartcard number range#n>>**

Example (targeting range of smart card number ranges, 8 bytes each)

Range: 1127154176 (dec) to 1127154432 (dec)

Will be signaled as:

02 00 00 00 00 43 2F 02 00 00 00 00 00 43 2F 03 00 (hex)

The first byte (0x02) indicates that a range of serial numbers will follow. Two serial numbers is then defined (8 bytes each). The first serial number is the first in the range and the second is the last in the range.

12.7.8 target_serial_number_descriptor

12.7.8.1 General

This section specifies the NorDig extensions to the target_serial_number descriptor, see also ref [1]. The following rules shall apply:

- If a target serial number descriptor is not present in the SSU stream, all individual IRDs for the given IRD model shall be updated (as for SSU simple profile).
- If a target serial number descriptor is present in the SSU stream, the IRD shall react on an SSU request only if it is explicitly targeted in the data field of any of the targeting descriptors. This means that if a targeting descriptor without private data bytes is received, no IRDs shall be updated.
- If multiple target descriptors are present, the IRD shall react on an SSU request matching either of the descriptors.

12.7.8.2 NorDig serial number private data byte definition

The serial numbers will be represented either as a list of individual serial numbers or ranges of serial numbers.

A serial number descriptor shall contain only one of the targeting types below. If both are used, they shall be sent in separate serial_number_descriptors.

- **List mode='0x01'** as the first byte in the serial_data_byte defines a list of smart card numbers
- **Range mode='0x02'** as the first byte in the serial_data_byte define one or multiple ranges of IRD serial numbers.
- **0x03-0x1F reserved for future use**
- **0x20-0x50 user defined**

12.7.8.2.1 *Format of the list mode*

Format of the list mode shall be:

01 <serial number #1> <serial number #2> <serial number#3> ...<serial number #n>

Example (targeting of 3 serial numbers, 8 bytes each)

Serial number 1: 1297599827523287111 (dec)

Serial number 2: 184887162952 (dec)

Serial number 1: 2242633 (dec)

Will be signaled as:

01 12 02 00 2B 0C 22 38 47 00 00 00 2B 0C 22 38 48 00 00 00 00 00 22 38 49 (hex)

The first byte (0x01) indicates that a list of serial numbers will follow. The next 8 bytes represent the first serial number, the next 8 bytes the next and so on.

12.7.8.2.2 *Format of the range mode*

It is possible to insert multiple ranges of serial numbers in the range mode:

Format of the range mode shall be:

02 <start serial number range#1><stop serial number range#1> ...

<start serial number range#n><stop serial number range#n>

Example (targeting 2 ranges of serial numbers)

Range 1: 289356241698816 (dec) to 289356275253247 (dec)

Range 2: 570831218409472 (dec) to 570831251963903 (dec)

Will be signaled as:

02 00 01 07 2B 00 00 00 00 00 01 07 2B 01 FF FF FF 00 02 07 2B 00 00 00 00

00 02 07 2B 01 FF FF FF (hex)

The first byte (0x02) indicates that range(s) of serial numbers will follow. Two serial numbers is then defined (8 bytes each). The first serial number is the first in the range and the second is the last in the range. The remaining 16 bytes gives the second range.

12.7.9 Message descriptor

The message descriptor shall be supported in accordance with ETSI TS 102 006 [31].

The text information contained in the Message Descriptor shall be presented to the user in the chosen language when new software update is detected. If also target descriptors is signaled, only targeted IRDs shall present this message descriptor .

In case of missing descriptor the default SSU message shall be displayed. The default message is operator specific.

12.8 Related Content Table (NorDig PVR only)

The syntax of the Related Content Table (RCT) is described in (section 10.4 of) ETSI TS 102 323 [34].

Informative: The RCT is typically used during a promotion trailer to give the viewer the opportunity to program/book the PVR to record the event the trailer is referring to, here referred to as a trailer booking (or promotional linking) feature. The RCT may include several trailer/promotion links, see below. The Related Content Table (RCT) provides related content information which is relevant to the content currently broadcast on a service.

12.8.1 Related Content Table Descriptors

Related Content Table
short_event_descriptor
image_icon_descriptor

Table 12.31 RCT descriptors

12.8.2 Description of RCT

Informative: The RCT carries service specific real-time links to other content. The presence and details of these links change dynamically. When links are available a suitably enabled NorDig PVR that supports Trailer booking can display these to a viewer using its native User Interface: firstly through an indication that links are active (e.g. an icon to say 'press green to book') and then by displaying the list of links (see 14.3.10).

If the links in the RCT table point to other broadcast content then the viewer can choose to book that content to be recorded, through the recorder's usual native booking mechanism.

12.8.2.1 RCT general

The NorDig PVR that supports Trailer booking shall support:

- RCT sub-table that may be split over multiple sections.
- The total size of an RCT sub-table (all sections) up to 65535 bytes.
- The stream type of the RCT in the PMT reference is 0x05 and RCT use table_id 0x76.

(The NorDig PVR does not have to handle any cross carriage of RCT information).

12.8.2.2 RCT version number and link count

A change of RCT version number and link_count greater than zero refers to that trailer booking icon shall appear (be displayed) according to user preference settings.

A change of RCT version number and link_count equal to zero refers to that any trailer booking icon shall disappear

See section 14.3.10 for PVR handling of RCT version number and link count.

12.8.2.3 Signalling of icons in multiple links

NorDig PVR supporting Trailer booking shall handle up to one trailer booking icon at the time to be displayed.

Informative about the broadcast: The set of links of type Trailer or GroupTrailer transmitted in an RCT concurrently shall only signal a maximum of one icon to be displayed. As a consequence, within a single RCT, the broadcaster shall not signal links requiring both the default icon and the transmitted icon. However, the broadcaster may signal that the default icon shall be displayed if the transmitted icon has not been acquired.

If any Trailer or GroupTrailer link in the RCT has an icon_id which is non-zero, then all other Trailer or GroupTrailer links in the RCT must either indicate that same icon_id or must have both icon_id and default_icon_flag as 0 (no icon for the link).

The NorDig PVR that supports Trailer booking shall be able to handle image_icon_descriptors in the RCT which are unreferenced by any icon_id in the link_info structures currently being transmitted. IRDs may use this to assist caching of transmitted icons.

12.8.2.4 Number of Links

The NorDig PVR that supports Trailer booking shall handle at least 10 links of the types Trailer and GroupTrailer that are signalled concurrently.

12.8.2.5 Order of Links

The NorDig PVR that supports Trailer booking shall display Links on-screen in the same order they appear in the link_info loop of the RCT.

12.8.2.6 Link Stacking

The NorDig PVR shall assume that link first in the list shall be most relevant to the current broadcast content. An IRD may also offer recent related content information with the current set of links.

12.8.2.7 Link Types

The NorDig PVR that supports Trailer booking shall support (only) link_type 0x00 (URI string only). All other link types shall be ignored by the NorDig PVR. The URI string within the media_uri_byte can be a programme or series CRID.

The CRID may be resolved to an event through the EIT table (to provide more information to the viewer about the event, ie EIT description (short + extended) has preference compared to RCT description short descriptor).

12.8.2.8 CRID Resolution and Retention

The CRID may not be resolvable from the EIT when the RCT is signalled (due to that event broadcast time is too far ahead) however the NorDig PVR that supports Trailer booking shall still support a booking to be made.

Any booked CRIDs shall be retained by a NorDig PVR for up to 91 days. If a CRID has not been seen in EIT after 91 days it shall be removed from the NorDig PVR's booking list.

For NorDig PVR that supports Trailer booking a CRID in the RCT without an IMI shall resolve to matching both CRIDs in EIT with and without IMI extension and a CRID in the RCT with an IMI shall resolve to first preference matching CRIDs in EIT with IMI extension, ie:

- *crid://dr.dk/ABC* in RCT shall match either *crid://dr.dk/ABC* or *crid://dr.dk/ABC#1*
- *crid:// dr.dk//ABC#1* in RCT shall as a first preference match *crid:// dr.dk//ABC#1* however, during clash resolution, a IRD may fall back to an alternate instance with or without any IMI.

Informative about the broadcast: Resolution of a CRID in the RCT to events in EIT shall include the complete CRID, including any IMI extension except where a conflict occurs, where a NorDig PVR may fall back to an alternate instance with or without any IMI.

Where an IMI is supplied with a CRID in the RCT the associated promotional text shall indicate the reason for targeting a preferred instance, e.g. a signed version.

12.8.2.9 HowRelated Classification Scheme

Each link is described within a TVAnytime HowRelated classification scheme. The `how_related_classification_scheme_id` shall be 0x02 (urn:tva:metadata:HowRelatedCS:2007).

All other classification schemes shall be ignored by the NorDig PVR. A NorDig PVR that supports Trailer booking shall continue to operate and process links of known classification in the presence of undefined classifications in the link info loop.

12.8.2.10 HowRelated Types

The following TV-Anytime HowRelated types shall be supported by NorDig PVR that supports Trailer booking. The value coded in column 1 of Table 12.32 `_RCT term_id` shall be carried in the `term_id` field of the `link_info` structure of the RCT. This is the `_rank` of the TVA termId in the HowRelatedCS:2007 classification scheme, see ETSI TS 102 323 [34]. Other types may be signalled in the future and any HowRelated types not defined in this document shall be ignored by a NorDig PVR.

A NorDig PVR that supports Trailer booking shall continue to operate and process known types in the presence of undefined types in the link info loop or types that the IRD is unable to process.

RCT term_id as coded	TVA termed In HowRelatedCS:2007	Name	Definition	NorDig PVR behaviour
0x002	1.2	IsTrailerOf	The reference points to a resource of which the currently described resource is a trailer	NorDig PVR will offer (through dialogue) the user the option book the pointed to programme (programme CRID) for recording.
0x005	2.2	IsGroupTrailerOf	The reference points to a group of resources for which the currently described resource is a trailer.	NorDig PVR will offer the user option to book the pointed series (series CRID) for recording

Table 12.32 HowRelated types for Trailer Booking Service

12.8.2.11 Promotional Text

A NorDig PVR IRD that supports Trailer booking shall support Promotional text for each link. The Promotional text shall only be used at the time of booking (ie when displaying the trailer booking menu on screen). The character set of the text field is specified in section 12.1.7.

Informative about the broadcast: Promotional text shall accompany each link. It shall describe the event being promoted in a form which is suitable for display to the viewer. There shall be sufficient information carried to allow the viewer to identify the content.

Broadcasters shall not indicate the link type in the promotional text: further assistance shall be provided by the IRD software, e.g. “Book this series”.

A short event descriptor shall also be included (including the trailer’s event name) and displayed according to the rules set out in chapter 12.8.3. (Therefore there is no need to include the event name in the promotional text).

12.8.3 Short Event Descriptor (when used in RCT)

A NorDig PVR that supports Trailer booking shall support `short_event_descriptor` and its event name field, (as defined in ETSI EN 300 468 [15]), that is included in the `link_info` descriptor loop of each link in the RCT. Once a CRID carried in the RCT is resolved to an event in the EIT then the booking list shall use the `short_event_descriptor` in EIT in preference to the descriptor carried in the RCT.

Informative about the broadcast: The short event descriptor will typically only include event name and the event description text length shall be zero.

12.8.4 Image Icon Descriptor

A NorDig PVR that supports Trailer booking shall support (as defined in defined in ETSI EN 300 468 [15]):

- image icon descriptor,
- icons delivered inside the image icon descriptor and
- icon image types PNG type and JPEG type

Informative: The image icon descriptor, may be used to convey or reference an image, to be used to indicate for the viewer a trailer booking (instead of the PVR's default trailer booking icon). A broadcast icon may be delivered in an image icon descriptor. This descriptor may be delivered in the 'link info' descriptor loops or in the outer loop of the RCT. Where the descriptor is carried in the outer loop multiple links may reference the same icon through `icon_id`. An icon may be split across multiple descriptors. The icon image type may be either PNG type or JPEG type. SD services shall use image type only at SD resolution. HD services shall carry image types at HD resolution.

12.9 NorDig Broadcast Record List syntax (NorDig PVR only)

NorDig Broadcast Record list is only applicable for PVRs and is an optional to support for NorDig PVR.

12.9.1 Introduction (informative)

Broadcast Record Lists is a “broadcast only” functionality (independent of return channel and API). Broadcast Record Lists, or with other words "Record lists for Catch-up TV" is a method by which broadcasters may signal in the broadcast stream particular content to be acquired by an enabled NorDig PVR that support this feature. Once a user has selected a record list, a PVR will acquire and manage the content without any additional user intervention.

This functionality will enable broadcasters to promote particular content, expose users to niche programming or expose viewers to content that is commercially attractive for example. It also allows broadcasters to use spare multiplex capacity for the pre-delivery of content.

Broadcast Record Lists are lists of content where each has a consistent theme such as “the best of the last week” or “classic films”. Each list will carry metadata including a descriptive title and synopsis, along with a unique identifier in the form of a CRID. When a user selects a record list, events referenced by that list will be automatically booked and then acquired without further user intervention. The signalling will carry the metadata required for the NorDig PVR to automatically capture, store and expire recorded content.

The Broadcast Record Lists specification allows a wide range of functionality such as the creation of record lists, ability to deliver content off the schedule, the ability to deliver content in an obfuscated (“hidden”) manner and the ability to mandate embargo and expiry times.

It is believed for this function that users will subscribe to one or more Broadcast Record Lists over a longer time and therefore it is essential that PVR can automatically delete expired events and priorities recorded content to avoid PVR memory becoming full due to this feature.

The metadata required to support Broadcast Record Lists specification is made available using the TV-Anytime XML model (TS 102 822-3-1 [69]).

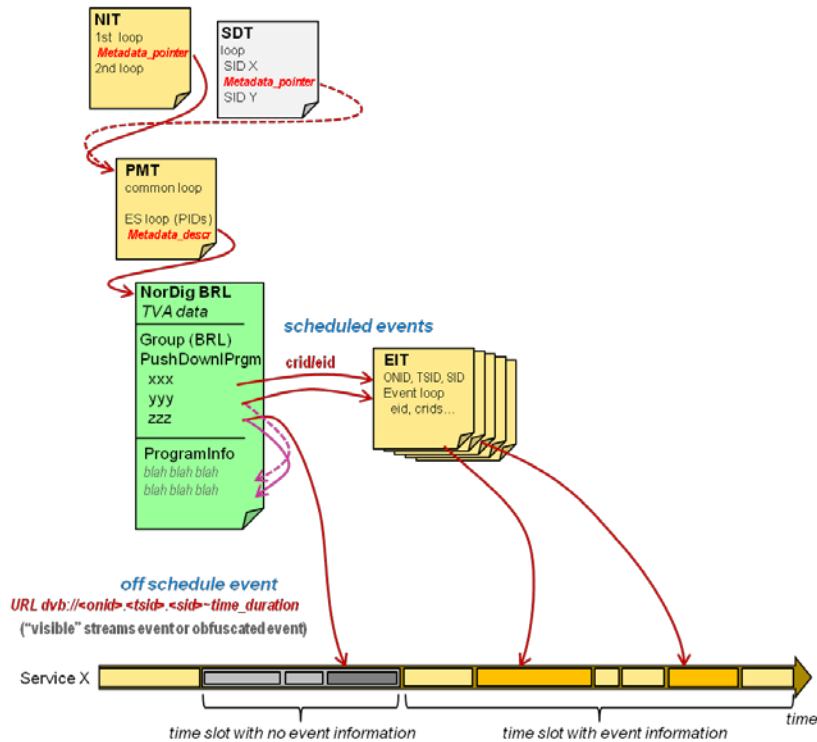

Figure 2 Signaling model for NorDig Broadcast Record List (BRL).

The root to a BRL starts either from the NIT or the SDT to a service which PMT includes a pointer to the PID carrying the BRL data including its “Push download” events. For most scheduled events the PushDownloadProgram will resolve to an event in the EIT (and from the EIT the PVR will be able to pick up the start time, duration, program title and synopsis of the event). There is also specified a mechanism for BRL events to reference without EIT, here referred to as off-scheduled events, where the event will include an TV Anytime URL DVB locator including start time and duration and for the title and synopsis the event will be delivered using a TV-Anytime ProgramInformation table.

12.9.2 General

This NorDig Broadcast Record List is optional for NorDig IRDs/PVRs to support, but if supported then all requirements for this NorDig Broadcast Record List feature shall be supported.

NorDig Broadcast Record List functionality is enabled by the use of a subset of the TV-Anytime XML specification TS 102 822-3-1 [69].

For compatibility with future updates to this functionality and to satisfy TS 102 822-3-2 [71], NorDig IRD shall ignore unrecognised XML elements and sub-elements if the XML is otherwise well formed. XML fragments containing malformed XML may be ignored in their entirety. Receipt of unrecognised XML elements or malformed XML shall not cause the receiver to malfunction.

12.9.3 NorDig Broadcast Record List Metadata Carousel Discovery

The carousel carrying the NorDig Broadcast Record List TV-Anytime metadata shall be identified using a metadata pointer descriptor and a metadata descriptor as defined in ETSI TS 102 323 clause 5.3 [34]. The metadata descriptors extension will be present in both the metadata pointer descriptor and metadata descriptor.

NorDig PVR supporting BRL shall support all PSI/SI descriptors listed in section 12.9.3.1 for the BRL service.

12.9.3.1 PSI/SI Descriptors for NorDig Broadcast Record Lists

Descriptors for Record list stream	Table	See chapter
Metadata pointer descriptor	NIT	12.2
Metadata pointer descriptor	SDT	12.3
Metadata descriptor	PMT	12.6

Table 12.33 PSI/SI descriptors for NorDig Broadcast Record Lists

The scope implied by the location of the metadata pointer descriptor shall be respected. If the metadata pointer descriptor is delivered in the NIT, the metadata shall be valid for the network (ie inside that original_network_id).

12.9.4 Content Grouping

Groups of related content (record lists) will be signaled via using TV-Anytime groups with a group type of “automaticAcquisitionThemed” or “automaticAcquisitionNonThemed”.

12.9.5 List Hierarchies

A Recording List may contain a further reference to one or more recording lists in order to create a hierarchy. The NorDig PVR supporting BRL Broadcasters shall support Broadcast Record List hierarchy up to five levels (excluding the mandatory default record list described in 12.9.6).

Note: It is the broadcaster’s responsibility to ensure no loops are created before the metadata is published.

12.9.6 Default Record List Group

The Record List acquisition functionality shall have a root record list that shall be identified by a well-known CRID which shall take the form:

crid://<authority>/default1.

Where <authority> is derived from the default group authority structure 12.2.2.2, found in the metadata descriptors extension 12.2.2.1. All groups that have this group as their root are conformant to and shall be treated as defined in this document.

Groups that do not have the default group at the root of their hierarchy shall be ignored by the NorDig PVR supporting BRL unless specifically recognised. In this case they may be treated in a manufacturer defined manner.

12.9.7 Embargoed Content

The ActivationTime element may be used in the PushDownloadProgram and specifies the date and time for embargoed content. Used to signalize from what time this BRL recorded content shall earliest be playable for the user, see 14.2.10.8, before this time is reached the recorded content is “embargoed”.

If no embargo time is signalled for a piece of content it is assumed that content is available for viewing immediately.

12.9.8 Content Expiry

The ExpiresTime may be used in the PushDownloadProgram and specifies the date and time after which the associated instance of the content shall no longer be playable by the user and be deleted, see 14.2.10.9. In NorDig BRL both normal scheduled events and off-scheduled events may have ExpiresTime (observe difference compared to DTG D-book).

12.9.9 Scheduled event

A NorDig Record List scheduled event is a pointer using EIT, which in the Record list includes either only CRID or a URL DVB pointer with event_id to the event.

A scheduled delivery to event in the EIT that in the EIT do not carry any CRID shall be identified by the presence of a ProgramURL in the PushDownloadProgram. In this case, the CRID carried by the

PushDownloadProgram fragment shall not resolve to any event carried in any EIT. The content of the URL element shall provide the means to locate and acquire an instance of a broadcast event.

The signalled URL shall take the following forms and be interpreted as described in TS 102 323 clause 6.4 [34], as to reference an item of content by its scheduled time for broadcast:

To reference an item of content via an event_id carried in EIT:

```
dvb://<original_network_id>.[<transport_stream_id>].<service_id>;<event_id>
```

Different configurations of URL may be used in the future to signify different methods of acquisition or event. NorDig PVR shall ignore any URL format it cannot interpret and events in any location from where they cannot be acquired. A PushDownloadProgram CRID corresponds to a program CRID or event_id for a service either currently in the EIT or a program CRID that shall be broadcast at a later date (up to maximum 91 days in ahead).

A PushDownloadProgram ProgramURL with event_id to a specific service corresponds to an event_id for the service either currently in the EIT or an event_id for that service that shall be broadcast at a later date (up to maximum **10** days in ahead). (The event_id has shorter period of validity compared to the CRID, this since the event_id is re-used in the broadcast for other events typically after 30 days).

12.9.10 Off Schedule Event

A record list off-schedule event is a pointer without using EIT, which includes URL DVB pointer to the service and the start time plus duration for the recording.

An off-schedule delivery shall be identified by the presence of a ProgramURL in the PushDownloadProgram. In this case, the CRID carried by the PushDownloadProgram fragment shall not resolve to any event carried in any EIT. The content of the URL element shall provide the means to locate and acquire an instance of a broadcast event.

The signalled URL shall take the following forms and be interpreted as described in TS 102 323 clause 6.4 [34], as to reference an item of content by its scheduled time for broadcast:

To reference an item of content by its schedule time for broadcast:

```
dvb://<original_network_id>.[<transport_stream_id>].<service_id>~time_duration
```

(According to TS 102 323 clause 6.4 [34], the format for the time_duration string shall be compatible with ISO8601 and observe that DVB specified using UTC time and that the start time and duration is separated by two hyphen “-“ characters rather than by one solidus (forward slash) “/” character, example 20120606T094500Z—PT01H15M00S).

Different configurations of URL may be used in the future to signify different methods of acquisition or event. NorDig PVR shall ignore any URL format it cannot interpret and events in any location from where they cannot be acquired.

Where an event is to be delivered off-schedule, the CRID carried by the PushDownloadProgram match the CRID of a ProgramInformationFragment. This ProgramInformationFragment will provide, at minimum, a title and synopsis for the off-schedule event.

Alternate instances of an off schedule event are indicated by multiple instances of a PushDownloadProgram with the same identification CRID but different ProgramURLs. The InstanceMetadataID element of the PushDownloadProgram is used to differentiate between these multiple instances. The value of InstanceMetadataID is unconnected to an IMI extension for a CRID in the EIT

12.9.10.1 Obfuscated Events (subset of Off Scheduled Events)

Off schedule events may be delivered in an obfuscated manner in order to make them inaccessible to IRDs not supporting NorDig Broadcast Record Lists. In order to hide an event, the stream types of the service's elementary streams (video, audio, teletext, subtitles) are all set to 0x06 (PES private data) in the associated PMT. The true stream type/component types are instead signalled using the event locator URI.

An obfuscated event may be recognised by the presence of a ProgramURL element in the PushDownloadProgram fragment where the contained URI has the following form

```
dvb://<original_network_id>.[<transport_stream_>].<service_id>.fully_qualified
_component *( "&" fully_qualified_component )~timeduration
```

Where

```
fully_qualified_component = "fqc=" stream_content_and_component_type ","
component_tag *( [ "," iso639_language_code ])
```

The elements of this URI are defined in DVB draft ETSI TS 102 851 (*Uniform Resource Identifiers (URI) for DVB Systems*) [72]. The URI shall contain at minimum a fully_qualified_component for the video and a fully_qualified_component for the main audio. Fully_qualified_components describing audio description and subtitles may also be present.

The PMT loop associated with the audio stream(s) shall carry the regular descriptors necessary for audio in the same way as for normal non-obfuscated service events (i.e. when necessary ISO 639, AAC, AC-3, supplementary audio descriptors etc).

If subtitles (via DVB subtitling and/or EBU Teletext subtitling) are present, the PMT loop associated with the subtitles shall carry a subtitling descriptor (for DVB subtitling) and Teletext descriptor (for Teletext subtitling) which shall be interpreted in the normal way.

The stream_content_and_component_type shall authoritatively signal the component types for each stream overriding any component descriptors in any associated EIT.

The CRID carried by the PushDownloadProgram signalling an obfuscated event shall match with the CRID of a ProgramInformationFragment. This ProgramInformationFragment shall provide, at minimum, a title and synopsis for the off-schedule event. All event information shall be retrieved from the associated ProgramInformation fragment, EIT information shall be ignored.

12.9.11 BRL CRID Lifecycle Management

Fundamental CRID lifecycle management for NorDig BRL remains as per the rules in NorDig Unified chapters 12.4.6 "CRID encoding and reuse" and 14.3.3 "Series recording".

12.9.12 Content Versioning

Updates to the version of a particular piece of content may be signaled using the ContentVersion element, indicating to the PVR to replace any earlier recorded version with this later version.

12.9.13 Version Changes (informative)

There are a number of places in the metadata where version changes can occur. The interaction of these changes can be summarised as in the table below.

Version number of module in DSM-CC object carousel	One or more of the files (containers) that this module is carrying has been updated. The container or containers transported by this module should be reacquired and the container header checked for version number changes.
Version change of referenced fragment in container header	The fragment associated with the version increment has changed in some way. Note the container itself has no associated version number.
Version change associated with TVAMain fragment	The contents of the TVAMain fragment have changed in some way. A change in a normal fragment will not trigger a version change for the TVAMain fragment, only if the TVAMain fragment itself changes will a version change be necessary.
Version change associated with XML for normal fragment	The contents of this fragment have changed in some way.

Table 12.34 Version changing of NorDig BRL information

12.9.14 Fragmentation of Record List Metadata

NorDig Broadcast Record List metadata is conveyed as a subset of a TV-Anytime metadata description (TS 102 822-3-1), represented in XML. TV-Anytime XML files are fragmented as defined in TS 102 822-3-2 clause 4.3.

Each fragment will have a fragment ID which will be a 6 digit hex string between 0x000001 and 0xFFFFFFFF (except TVA Main Fragment, see below). This fragment ID value is unique within the metadata service and are not be re-used for at least 32 days.

The value of the fragmentVersion attribute of each fragment shall be a 2 digit hex string. Each time the content of a fragment changes, the version number of that fragment is incremented modulo 0xFF.

Note: The broadcaster will ensure this value is unique within the metadata service and shall not re-use a fragment ID for at least 32 days.

12.9.14.1 New Fragments

A new XML fragment are inserted into an appropriate container or a new container as appropriate.

12.9.14.2 Deleted Fragments

Fragments may be removed from the metadata service. Fragments that cannot be found and are not referenced from a moved fragments structure shall be deemed to have been deleted.

12.9.14.3 XML Declaration

The XML declaration at the beginning of an XML fragment is optional and may be omitted for reasons of efficiency. If this declaration is not present, the defaults of XML version 1.0 and UTF-8 encoding shall be assumed.

12.9.14.4 Fragment Encoding and Termination

The XML text for each fragment carried in the binary repository of the container are encoded as UTF-8. The text of each fragment carried in a binary repository are terminated with a null character 0x00 (TS 102 822-3-2 [71]).

12.9.14.5 Carriage of Fragment Version and ID

For efficiency, the version and ID shall be removed from the fragment XML as part of the containerisation process and instead these values shall only be carried in the encapsulation structure for that fragment.

12.9.14.6 TVAMain Fragment

A NorDig BRL will contain a TVAMain fragment and is carried in its own container with the filename "tvamain". The TVAMain fragment will have the fragment ID 0x000000 in the tvamain encapsulation structure.

A version change for the TVAMain fragment shall force a NorDig PVR supporting BRL to reacquire all fragments in the metadata service. The version of the TVAMain fragment signalled in the encapsulation structure should be checked, even if the PVR detects file has been updated.

12.9.15 Carriage of XML Fragments

The specification for carriage of TV-Anytime XML for NorDig BRL is a profiling of TS 102 323 [34] clause 8 with the distinction that binary encoding is not used.

12.9.15.1 Containers

All data for the NorDig BRL TV-Anytime metadata service are carried in containers as defined in TS 102 822-3-2 clause 4.5.2.1.

If one or more fragments are carried in a container then an encapsulation structure and a binary data repository will both be present. A moved fragments structure may be present if required.

The maximum size of a single container is 64Kbytes.

12.9.15.2 Container Identification

Each container will have an identifier which shall be a value between 0x0000 and 0xFFFF. This identifier is unique within the metadata service at any one time and broadcasters shall ensure container IDs are not re-used for 32 days.

12.9.15.3 Encapsulation

The encapsulation structure are as defined in TS 102 822-3-2 [71] clause 4.6.1.1 *Encapsulation structure*.

The value of the fragment_reference_format for NorDig BRL is 0xF0. Use of this value shall indicate an unencoded_fragment_reference structure is to be used in the loop of the encapsulation structure.

The unencoded_fragment_reference structure is defined as follows:

Syntax	No. of Bits	identifier
unencoded_fragment_reference(){		
unencoded_fragment_pointer	16	Uimsbf
}		

Table 12.35 Unencoded fragment reference

unencoded_fragment_pointer: Offset in bytes from the start of the binary repository to the first byte of the fragment.

Fragments are described in the loop of the encapsulation structure in the same order with which they are placed in the binary repository (in order of ascending fragment ID). Maintaining consistency of fragment ordering between the encapsulation and binary data repository may allow the receiver to determine the length of each fragment by using adjacent unencoded_fragment_pointer values.

12.9.15.4 Moved Fragment Structure

The moved fragments structure are constructed as defined in TS 102 822-3-2 [71] clause 4.6.1.2 *Moved fragments structure*.

If a fragment is moved from one container to another, the original container will carry a moved fragments structure and use it to signal the new location of the fragment. The entry in the moved fragment structure will be present for the lifetime of the moved fragment.

A container may contain only a moved fragments structure and no binary repository if necessary.

12.9.15.5 Binary Data Repository

Fragments are carried in the binary data repository structure as detailed in TS 102 822-3-2 [71] clause 4.6.1.4.1 *Binary data repository*. Fragments are placed in this structure in order of ascending fragment ID.

12.9.16 Carriage of Containers

Containers for a single metadata service are carried as file objects in an object carousel as profiled in TS 102 323 [34] section 9.2.1 *Delivery by MHP object carousel*. All containers are located in the directory signalled by the metadata descriptor relating to this metadata service. Multiple metadata services may co-exist in the same carousel, providing each is carried in a separate directory. A single metadata service cannot be spread over multiple directories.

Each file object shall contain exactly 1 container.

The container's ID shall be signalled using the filename as described in TS 102 323 [34] clause 9.2.2 *Container identification*. Thus the name of a file carrying a container shall consist of 4 hex digits followed by the extension ".d" (data container).

12.9.17 NorDig BRL's TV-Anytime XML profile

The following section provides a profile for TV-Anytime (TVA) XML for used to support NorDig Broadcast Record List (BRL) functionality. The symbol "@" has been used to denote an attribute.

All elements and attributes in this section are mandatory for NorDig PVR supporting BRL to support and mandatory to broadcast unless specified otherwise.

The types for and definitions of all elements and attributes contained in the broadcast XML metadata are as set out in TS 102 822-3-1 [69] and the associated schema unless overridden or otherwise clarified by the profile in this NorDig section.

Some attributes are *optional to broadcast*, refereeing to they are not always included instead they are normally only included when they are needed. NorDig PVR supporting BRL shall however support when they are included and handle when they are not included.

12.9.17.1 Synopsis NorDig BRL TVA XML

Where a synopsis element is present, a length attribute are included as detailed in TS 102 822-3-1 [69]. In case of parallel broadcast of different synopsis having different length, it is sufficient if the PVR store only the longest one.

Only one synopsis length shall be displayed at one time.

12.9.17.2 Language NorDig BRL TVA XML

A 2-character code as defined by ISO 639-1 [70] shall be used to signal the language where appropriate. These language codes are shown with their current equivalents in Table 12.36.

Language	XML 2-character language code (ISO 639-1)	NorDig language code (ISO 639-2)
English (default)	"en"	"eng"
Irish	"ga"	"gle"
Danish	"da"	"dan"
Finish	"fi"	"fin"
Norwegian	"no"	"nor"
Swedish	"sv"	"swe"

Table 12.36 Language codes that shall be supported by NorDig PVR BRL

12.9.17.3 TVAMain Type

TVAMain	Profile
@lang	The language attribute will always be present and will indicate the primary language for the metadata service.
@publisher	The publisher attribute will always be used to signal the publisher of this metadata according to TS 102 323 [34] clause 8.9.

Table 12.37 NorDig BRL TVA Main typeMetadataOriginationInformation Type

MetadataOriginationInformation	Profile
@OriginID	A value used to uniquely identify this MetadataOriginationInformation instance. An OriginID exist for every metadataOriginIDRef in the metadata.
Publisher	A human readable name of the publisher. The maximum length of this string is 20 characters, aligning with the Service Provider Name field in the Service Descriptor.

Table 12.38 NorDig BRL Metadata Origination Information TypeGroupInformation Type

GroupInformation	Profile
@lang	A lang attribute may be included to indicate the language used in any textual descriptions contained in this fragment and shall override a language set by the TVAMain fragment. <i>Optional to broadcast.</i>
@groupID	A unique identifier in the form of a CRID for the Record List.
@metadataOriginIDRef	An identifier that shall resolve to the originator of this Group.
@ordered	Set to true if child groups shall be ordered. <i>Optional to broadcast.</i>
GroupType	
@value	Groups associated with the Broadcast Record List service shall have the Group Types "automaticAcquisitionThemed" or "automaticAcquisitionNonThemed".
BasicDescription	
Title	Title of the Record List. The maximum length of the title shall be 40 characters.
Synopsis	A short description of the record list's content.
Genre	If present shall contain a term ID from ContentCS (TS 102 822-3-2 [71] Appendix A.8). Multiple genres may be present. <i>Optional to broadcast.</i>
MemberOf	Allows the creation of recording list hierarchies by holding a reference to a more general recording list. Mandatory for all groups apart from the default group.
@crid	A CRID referencing a more general group. <i>Optional to broadcast.</i>
@index	Used to determine ordering if the parent Group indicates ordering on child Groups. <i>Optional to broadcast.</i>

Table 12.39 NorDig BRL Group Information Type

Note: the xml:lang attribute will not be used in the Title or Synopsis elements, instead this will be signaled as an attribute of GroupInformation and inherited accordingly

12.9.17.4 PushDownloadProgram Type

PushDownloadProgram	Profile
Program	
@CRID	This CRID indicates the event which should be resolved via the EIT and booked for automatic acquisition. If a ProgramURL with time_duration is also present, the event is to be delivered off schedule and so this CRID will not resolve to an EIT event. Instead it shall be matched with an entry in the ProgramInformationTable
ProgramURL	An alternative location for the event, provided as a URL. See 12.9.4, 12.9.9, 12.9.10 and 12.9.10.1.
InstanceDescription	
MemberOf	Contains one or more CRIDs identifying the group or groups to which this PushDownloadProgram belongs. Multiple instances of the MemberOf element may be present indicating the PushDownloadProgram belongs to multiple groups
PublishedDuration	The duration of the event. Suitable for display to the user but a more accurate duration shall be determined using the EIT or DVB locator.
ContentVersion	The version of the associated content. This value shall be represented as a two character hex string. The value will increment whenever the content is updated, modulo 0xFF. <i>Optional to broadcast.</i>
ExpiryTime	If present, this specific piece of pushed content will expire at the indicated time and may be removed from the receiver depending on user preferences, see section 12.9.8. If not present, the content is playable indefinitely as long as the recording remains in the PVR. <i>Optional to broadcast.</i>
ActivationTime	This value shall define the earliest time at which a user may view the associated content (embargo date/time), see section 12.9.7. If this element is not present then the content is viewable immediately. <i>Optional to broadcast.</i>

Table 12.40 NorDig BRL Push Download Program Type

12.9.17.5 ProgramInformation Type

ProgramInformation	Profile
@ProgramId	A CRID identifying the content to which this ProgramInformation relates.
@lang	A lang attribute may be included to indicate the language used in any textual descriptions contained in this fragment and shall override a language set by the TVAMain fragment. <i>Optional to broadcast.</i>
BasicDescription	
Title	Title of the program. The maximum length of the title shall be 40 characters.
Synopsis	A short description of the event. <i>Optional to broadcast.</i>
TVAParentalGuidance	<p>A parental rating code for the programme, Defined as an TV-Anytime extension to the MPEG-7 datatype, ParentalGuidanceType (see clause 9.2.3 of ISO/IEC 15938-5 for a detailed specification). <i>Optional to broadcast</i></p> <p>The Parental Guidance when used shall include a <i>MinimumAge</i> (a non negative integer), which minimum suitable viewing age. Used values are 0 and 3-18 years. 0 refers to suitable for all ages. (<i>MinimumAge</i> equal to DVB parental rating descriptor's <i>rating</i> minus 3).</p> <p>ParentalGuidance's <i>Region</i> refers to <i>Country</i> in NorDig, ie MPEG7 countryCode, using the 3-character code in accordance with ISO 3166-1. ParentalGuidance's <i>Region</i> is used when there is difference of parental rating (<i>MinimumAge</i>) between coverage countries. When the <i>Region</i> is not specified, then the parental guidance applies for all countries (<i>ie then it is optional to broadcast Region inside the TVAParentalGuidance</i>).</p>

Table 12.41 NorDig BRL Program Information Type

13 Navigator

13.1 General

The NorDig IRD shall implement a basic Navigator, which provides user access to system information, and allows the user to control the operation of the IRD. The Navigator is by definition part of the system software. A minimum functionality is required as specified below.

The Navigator shall include a service list function and a basic Event Schedule Guide (ESG), see EN 300 468 [15]. The Navigator shall also initiate bootloading, as described in chapter 10.

The Navigator shall support the Nordic and English languages.

13.2 Service List

13.2.1 Service List Requirements

13.2.1.1 Service List Requirements for IRDs, except for IP-based front-end

The NorDig IRD shall maintain a service list based on SI-information. The NorDig IRD identifies a service uniquely through the combination of `original_network_id`, `transport_stream_id` and `service_id`. (The broadcaster however shall make services uniquely identified in the broadcast through the combination of only `original_network_id` and `service_id`).

The service list shall include the services and should also include the corresponding network names. The service list can be completely updated by the user by initiating the tuning/scanning procedure(s) for the connected tuners (see section 3.1.2). The corresponding part of the service list shall be updated within 1 second after reception of an updated SI table; updates should be made each time the NorDig IRD is switched from active to stand-by and shall be made each time the NorDig IRD is switched from stand-by to active.

The IRD shall build up different sections inside one service list or build up several service lists, one for each different service category as the default IRD service list(s). Minimum three different sections/lists shall be supported for three different categories of `service_types` and they are 'TV', 'Radio' and 'Data'/other' services, (see 12.1.5 for service categories).

Whenever two or more services within same category are allocated to the same `logical_channel_number`, the NorDig HD IRD shall first prioritise the advanced codec services as stated in Table 12.1 above (see chapter 12.1.4 for priority between different services within same service category).

The service list shall be displayed to the user. The user shall be able to select a service from the displayed service list. The selected service shall appear immediately (see section 11.4).

The IRD should provide functionality for the viewer to build up additional personal service lists with the viewer's own preferred services (like mixed `service_type`) and own preferred order or manually re-order the default service list(s). If any network operator makes changes in his part of the service list, the NorDig should place new entries at the end of the corresponding part of the user service list.

The information in the descriptors specified in Table 13.1 and Table 13.2 shall be displayed. The original network operator name may be omitted in case only one network is available.

13.2.1.2 Service List Requirements for IRDs with IP-based front-end

NorDig IRDs with IP-based front-end shall support the Service Discovery mechanism specified in ETSI TS 102 034 [31] and the additions specified in section 13.4.

Based upon this mechanism, NorDig IRDs with IP-based front-end shall be able to generate and maintain a service list of all available services at any time.

13.2.2 Service list functions for the Network Information Table (NIT)

The NorDig IRD shall (1) make use of the descriptors listed in table 13.1 in all NIT_actual (the transport stream the NorDig IRD is tuned to) and NIT_other (other transport stream) tables available in order to update the service list (system delivery data, number of transport streams, logic channel number etc).

Note 1: NorDig IRDs with a terrestrial front-end shall be able to install and update the service list components even if the transport stream does not contain the terrestrial_delivery_system_descriptor in the NIT_actual and the NIT_other streams (NIT_actual: the transport stream the IRD is tuned to. NIT_other: other transport stream).

NorDig IRDs with a terrestrial front-end dedicated for stationary reception may receive TS including NIT_actual and NIT_other tables. Due to the nature of the terrestrial networks all the transport streams listed in the NIT_other can be impossible to be received. Therefore, before using the information in NIT_other tables, carefullness shall be taken.

NorDig IRDs with a terrestrial front-end dedicated for mobile and portable reception may also receive TS including NIT_actual and NIT_other tables. In that case information in NIT_other tables may have informative background use for faster service acquisition when receiver is moved from one coverage area to another coverage area.

NorDig IRDs with a IP-based front-end: Not relevant. See Annex C

A cable NorDig IRD should provide functionality for fast installation of services by typing the network_ID into the receiver. In such a case, the IRD shall process only that specific NIT (actual and other) table (with corresponding network_ID) from current/actual transport stream and only install/display services listed in that table's service_list_descriptors.

A Navigator shall never display services that the IRD is not able to receive or decode except for de-scrambling (i.e. a pure satellite IRD shall not display services which are described in NITother tables for secondary cable networks).

A NorDig IRD shall not install, be able to reach or display services or networks with original_network_ID and/or network_ID which are marked as 'private_temporary_use' as defined in ETSI ETR 162 [23] (i.e. an original_network_ID 0xFF00 – 0xFFFF and/or network_ID 0xFF01 – 0xFFFF). (This descriptor may be used by broadcasters to avoid confusing consumers with (shorter) test and demonstration transmissions).

Services that are not listed in NorDig Logic_channel_descriptor, shall be displayed in the service list(s) and shall be located last in the list (for that service_type).

NIT descriptors
Network_name_descriptor
Satellite_delivery_system_descriptor
Cable_delivery_system_descriptor
Terrestrial_delivery_system_descriptor
T2_delivery_system_descriptor (1)
Service_list_descriptor
(NorDig) Logic_channel_descriptor
Note 1: Descriptor is signaled in the extension_descriptor and is only applicable for NorDig IRD-T2.

Table 13.1 NIT descriptors

13.2.3 Service List functions for the Service Description Table (SDT)

The IRD shall (1) use the descriptors listed in table 13.2 from both SDT_actual and SDT_other tables to update the service list (service names etc.).

Note 1: Not relevant for NorDig IP IRD. See Annex C

SDT descriptors
Service_descriptor
CA_identifier_descriptor

Table 13.2 SDT descriptors

13.2.4 Network Evolution and Service Changes

The NorDig IRD shall (1) dynamically update the Service List whenever changes occur in the NIT and SDT tables (i.e. typically handling the version numbers of the tables).

Initiation of update in the Service List that the IRD is not able to perform in the ‘background’ without disturbances or user action/confirmation, shall (only) be made after manual power up or after user selection to an affected service/transport stream (e.g. when re-scanning is needed). Initiation of update in the Service List for services signaled as invisible should not require action/confirmation from user, (see section 12.2.9 NorDig private; Logic_Channel_descriptor (LCD) for invisible services).

Note 1: For NorDig IP IRDs this function is handled by updating the Service Provider Discovery Information and the DVB-IP ServiceOffering Records. The version_number shall be incremented whenever the content of these records changes, hence the NorDig IP IRD shall continuously monitor the version_number.

13.3 Event Schedule Guide (ESG)

The Event Schedule Guide (ESG) is part of the Navigator in the IRD and presents program event information for the user about its installed services via a Graphical User Interface (GUI) as defined by the IRD manufacturer.

13.3.1 ESG Requirements

13.3.1.1 ESG and length

The NorDig IRD shall be able to display an ESG for the user with a minimum of eight days (1) of schedule data, defined as whole days from present day and ahead according to EN 300 468 [15]. The ESG shall be based on the information from the EIT tables, see section 12.4 and EN 300 468 [15].

Comment: Eight days of schedule data for the services within one NorDig network (original network) consists of typically of up to 2-4 MB of data per language.

Note 1: Eight days of ESG is optional for NorDig Basic IRDs (without PVR) that are launched before July 2015.

13.3.1.2 Proper handling of EIT data

The NorDig IRD shall maintain proper behaviour in case of the incoming event information data for the services exceeds the available free memory for the ESG and not affect the IRD’s basic service decoding and navigation.

If the NorDig IRD’s memory for the ESG is exceeded, then the NorDig IRD shall prioritize the event information nearest in time and first reduce the data most far ahead in time for all service, for example via using EIT table filtering (instead of reducing service by service). (If the user has made personalized favourite service list consisting of a subset of available services, then the NorDig IRD should first priorities favourite services and then events most nearest in time).

The NorDig IRD shall be able to handle situations when the EIT is not present.

13.3.1.3 ESG performance

The NorDig IRD shall maintain the full ESG up to date and be able to display the ESG within 10 seconds after selection, even if not all EIT sections have been received (in which case gaps may occur in timeline for some services). The NorDig PVR shall be able to present the ESG regardless of recording status (i.e. while recording or timeshifting an event, it shall be possible to present the ESG).

The NorDig IRD should cache EIT data during normal service viewing to speed up time to present a full ESG after selection.

The ESG shall be non-discriminatory and display all services on an equal basis.

The ESG shall process and display the relevant content of the following tables (including start-time, end-time/duration and content of all descriptors specified below in 13.3.2 and 13.3.3).

13.3.2 Event Information Table (EIT)

NorDig IRD shall make use of the EIT p/f tables from both EIT_actual and EIT_other tables.

Event descriptors	EIT p/f	EIT sch
Short_event_descriptor	M	M (1)
Extended_event_descriptor	M	M (1)
Component_descriptor	M	O
Content_descriptor	M	M (1)
Parental_rating_descriptor	M	M (1)
CA_identifier_descriptor (optional)	O	O
Content_identifier_descriptor	M (2)	M (2)

Table 13.3 EIT p/f descriptors

Note 1: EIT schedule is optional for NorDig Basic without PVR that are launched before July 2015 and for NorDig IRDs with IP-based Front-end.

Note 2: NorDig PVR only.

13.3.2.1 Dynamic update of EIT data

The EIT data shall be treated as dynamic information which means that the EIT data is often updated by the broadcaster several times during a day, for example

- The description of events may be changed/updated from when the event was first “published”/broadcasted,
- Some events may be re-scheduled,
- Past events from current day may be removed from broadcast etc.

As factory default, the NorDig IRD shall continuously monitor and update the ESG without user request to update (for example by monitoring the tables’ version ids). Information in the ESG shall be updated within 10 second after reception of the updated tables.

13.3.2.2 Multiple languages in EIT data

Some NorDig networks transmit EIT data in multiple languages; the NorDig IRD shall be able to display the EIT data from chosen language (according to user preferences).

13.3.2.3 Time periods with no EIT data or missing EIT data

If services have gaps in the EIT data or if services have no or missing EIT data the ESG shall not display an error message (i.e. it shall not give the impression for the user that IRD or the EIT data is faulty), instead the text information field should stay empty or display informative text (like “*No event information*”), see recommendation of informative text in Annex F. A gap in the EIT data refers here to a

gap in time between one event ends (start_time + duration) to the next event starts (start_time) for a service.

An example could be that when the IRD is still caching the EIT data (e.g. after startup) do not display any text information for events and services that are missing EIT data (typically due to that the IRD has yet not received that EIT data) and after a reasonable long time of caching (for example after analysing last_section_number etc) for missing EIT data then display informative text.

13.3.2.4 Parental Control from EIT data

The NorDig IRD manufacturer shall provide a functionality that allows the user to disable the parental rating control and configure certain parental rating values for blanking of video and muting of sound

13.3.2.5 ESG presentation filtering of EIT data

The NorDig IRD should provide a functions which allows the user to filter events in the ESG with the same content type (from content descriptor), events belonging to the same series (from content identifier descriptor), recommended events referred to by an event and to search events using keywords (from description).

13.3.3 Time and Date Table (TDT) and Time Offset Table (TOT)

The ESG shall display correct event times as conveyed by the TDT, adjusted by the offset relayed in the TOT and using the country name selected by the user.

Time Offset Table
Local_time_offset_descriptor

Table 13.4 TOT descriptors

Note: TDT contains UTC time, but no descriptors.

Additional requirements for NorDig PVRs (NorDig PVR only):

The ESG shall display all events using the correct time offset applicable at the event start time and date signalled in the EIT. The offset applied to the events UTC time shall be determined first on time of booking and subsequently updated if there is a new next_time_offset received. If there is more than one time_offset_section, ESG shall use the section that is applicable for event start time and date, see illustrative example in fig 13.1.

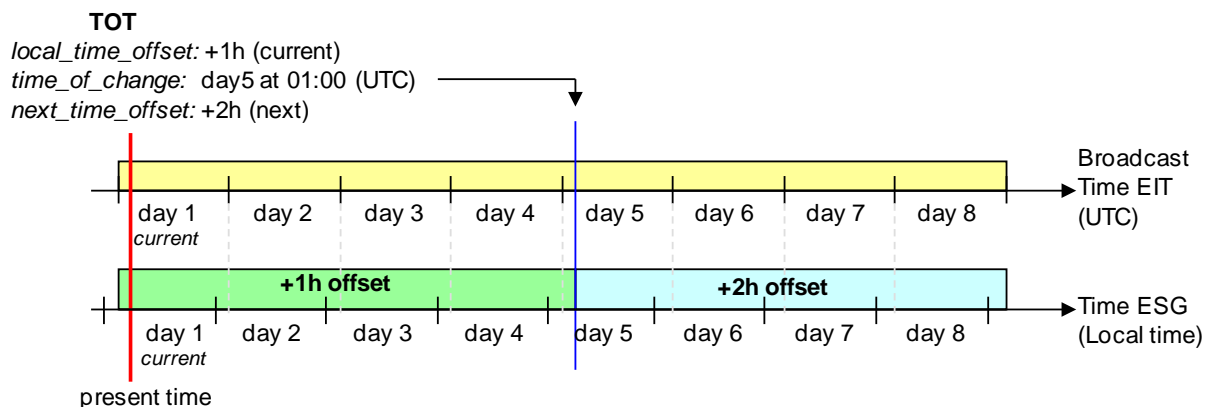

Figure 13.1 Example of time displayed via the ESG when the broadcast time information includes a shift from one to two hours time offset

13.4 Service Discovery and Selection for IRDs with IP-based front-end

Comment: NorDig has specified a set of requirements for Service Discovery and Selection for IRDs with IP-based front-ends, based on ETSI TS 102 034 [31]. This text is currently suspended, because it is

not used in Nordic networks that carry IPTV signals; service selection and discovery in these networks are all based on browser technology. A revised specification for SD&S, based on use of browser technology is being considered by NorDig

13.5 User Information (UI) about service components (audio and subtitling)

13.5.1 UI for Audio information

For services with multiple audio streams (PIDs), the NorDig IRD shall be able to display information about available incoming audio streams, for the user to temporarily select audio stream (see 6.5 and 6.11.4). Then the NorDig IRD shall (1) minimum include following information about the currently available incoming audios (listed in the PMT for the current selected service):

- Audio Language (if available)
- Audio Type (it shall be possible for the user to differentiate available supplementary audio stream(s) from “normal” audio stream(s) even when these have the same language)
- Incoming Audio format (multi/stereo)

This can for example be done via wordings and/or symbols etc. (As stated in 6.11.6 ‘receiver mixed’ audio shall not be decoded on its own).

The NorDig IRD should also display information about:

- Incoming Audio stream type (audio codec)

The NorDig IRD should for currently selected audio also display information about:

- Outgoing audio format (multi or stereo)
- Outgoing Audio stream type (uncompressed, DTS, DolbyDigital (AC-3) etc)

Note 1: Optional for NorDig IRD released before 1 July 2015.

13.5.2 UI for Subtitling information

The NorDig IRD first automatically selects subtitling stream/PID if several subtitling streams are available (DVB Subtitling stream/PID prio over EBU Teletext subtitling, see section 7.1).

The NorDig IRD shall (1) be able to display information about different incoming subtitling pages within the selected subtitle stream/PID, for the user to be able to temporarily select subtitling page or disable displaying subtitling. Then NorDig IRD shall be able to display following information about the subtitling:

- Subtitle language
- Subtitling type (it shall be possible for the user to differentiate available hearing impaired/hard of hearing subtitling pages from “normal” subtitling page(s) even when these have same language)

Note 1: Optional for NorDig IRD released before 1 July 2015.

13.6 Accessibility menus and settings

13.6.1 Accessibility settings

The NorDig IRD should support easy access to Settings for Accessibility Services by:

- Ensuring that Accessibility settings are made available using a minimum number of User Interaction steps (e.g. by use of dedicated remote control buttons),
- Grouping Accessibility settings together within the IRD's User Interface

13.6.2 Talking menus (optional)

Talking menus refers here to Text-to-Speech functionality in the IRD that use speech synthesis that typically reads the IRD's UI menus etc, this is to improve usage for blind or partially sighted users.

The NorDig IRD is recommended to support Text-to-Speech functionality and that it is implemented according with IEC 62731 [80]. If supported, then the NorDig IRD shall be able to enable and disable this Text-to-Speech feature see 16.2 and see chapter 16.4 for the IRD's factory default setting.

14 NorDig PVR feature requirements (NorDig PVR only)

14.1 Introduction - PVR

This chapter (together with PVR-related requirements specified in chapter 12 and section 13.3) specifies the minimum requirements for a NorDig PVR, which may record live services (TV, radio etc) in persistent memory (like HDD) for later playback, (even if the IRD has been completely powered off between the recording and the playback).

A NorDig PVR is a recordable IRD that fulfils all mandatory requirements specified in this chapter 14 (and relevant part in chapter 12 and 13), which among other things includes support for series recording, accurate recording, split recording etc. (A *NorDig IRD with some recording capability but which do not meet all mandatory NorDig PVR requirements is just a “NorDig IRD with recording capability”*).

NorDig recordable iDTVs that can not fulfil the requirements for Simultaneous Recording (14.3.8), is anyway recommended to support the other NorDig PVR requirements (like series recording, accurate recording, split recording, playback features etc).

Programming a recording (or booking) in the PVR refers to the user action of making a booking to record a live event, series and/or other broadcast content, either to be scheduled in the future or for immediately recording.

14.2 General - PVR

14.2.1 Recording File System

The NorDig PVR shall at all times keep a file system of the PVR's recordings and make them available upon request for the user to select and playback.

The user shall be able to list the recordings as:

- all recordings, as ordered by date&time

The user should be able to list the recordings as:

- all series (where all episodes of a series are group into same item in the list) and all non-series recordings
- all episodes of a specific series

For all recordings that have been programmed via the ESG or EPG, each recorded item in the NorDig PVR's list of recordings shall display for the user at least information about the recorded event's date of recording and event_name extracted from EIT data during the recording. If no event information is available for a specific recording then the service_name shall be used. For manual recording that span several events (excluding split events, see below), it is recommended to use the service_name instead.

In addition the NorDig PVR's list of recordings should display information about the item's time and duration of the recording and the description taken from the EIT (preferably all EIT data for the event, like short and extended description, etc). The description of the event (preferably from the EIT p/f data) could typically be presented when highlighting the recorded item in the list of recordings.

Due to the latency within all transmission of EIT data, it is recommended to wait 1 minute after the event's start_time or until the event's running status has become 'running' before acquire the event's EIT data (if EIT p/f is used).

The time and date in the list of recordings shall use the local time offset (based on the user's preferences settings), as applicable at the time of recording.

A NorDig PVR with IP front-end may use equivalent data to EIT data to display information about recorded items, if no EIT data is available inside the IP Network (as specified by the Operator).

14.2.2 Recording capacity

The NorDig PVR shall be able to indicate its momentary available recording capacity. The basis for the indication shall be explained in the instruction manual and should be in terms of capacity (e.g. GB), percentage or time (e.g. hours). (PVRs should consider when indicating available capacity in terms of time that many services often uses variable bitrate and that the capacity will vary between different services types, like SDTV, HDTV, radio etc)

The Manufacture shall clearly state the recording capacity for the NorDig PVR in marketing specification and in the instruction manual. It shall as a minimum be specified in terms of bytes (like GigaByte, GB etc).

14.2.3 Deletion of recordings

The user shall be able to manually delete any recorded event in the NorDig PVR by deleting one recording at the time. The user should be able to manually delete all recorded events in the NorDig PVR. The user should be able to manually delete all recorded events belong to the same Series in the NorDig PVR.

The NorDig PVR shall have a mode (set as factory default) where the NorDig PVR shall ask for user confirmation before deletion of recordings (i.e. the NorDig PVR may in addition have alternative mode where the NorDig PVR will delete recordings without any extra confirmation).

14.2.4 Failed and incomplete recordings

The NorDig PVR shall have a mechanism for informing the user of failed or incomplete (partial) recordings. For incomplete (partial) recordings it should inform the user how much of the booked event has not been successfully recorded.

14.2.5 Save only the last number of episodes

The NorDig PVR should be able to let the user set the PVR to save/keep a configurable number of the latest events (episodes) within a Series. If the user has set the NorDig PVR to keep a specific number of events in a series and the NorDig PVR has recorded more, then the NorDig PVR shall automatically remove the “oldest” event (without any additional user confirmation).

The criteria to decide which event is the “oldest” within a Series, shall be based on which event has the lowest TVA programme CRID value. If the NorDig PVR can not easily decide which event that has the lowest TVA programme CRID value (for example due to lack of digits inside the TVA programme CRID), then the PVR shall keep all recordings from that Series.

14.2.6 File system intact after update

The NorDig PVR’s file systems of recorded events shall be intact after

- updating of the PVR IRD’s System Software and/or
- updating of CA system and/or
- re-installation or update of installed services

14.2.7 Limitations in local storage, interfaces, extraction and removable media for recordings

Some of the broadcasted content is signalled as protected, for example via the CA-system, copyright and/or copy protection signalling as specified by the relevant network/CA operator.

The requirements for external interfaces of recordings, internal storage, limitation for extraction of protected content and for removable media for the NorDig PVR and other NorDig recordable IRDs are specified by the relevant network/CA operator.

For protected content (unless otherwise specified by the relevant network/Operator), it shall not be possible to extract or output content from the NorDig PVR and other NorDig recordable IRDs in unprotected format, therefore all recordings shall be stored in a protected format.

Some networks and operators require local scrambling for all recording, some other allows either local scrambling or original DVB scrambling etc.

NorDig PVRs' and other NorDig recordable IRDs using standardised removable media, such as DVD or Blu-ray for recording of protected content shall downscale any HD content to SD resolution (maximum 720x576) before storing it to the removable media. HD content may be recorded in its original resolution if the recording retains the original broadcast scrambling or any other local device scrambling approved by the Network/Operator. The downscaling should be made as specified in 5.11.

14.2.8 Disk management / de-fragmentation

The NorDig PVR shall have appropriate disk management (including de-fragmentation handling for Hard Disk Drive based PVRs) to minimise need for re-formatting disk during its lifetime.

14.2.9 Safe margins

The NorDig PVR should have the possibility to add extra recording time before and after the event's scheduled time, as a safe margin. Typically this could be done as a pre-defined default user preference setting value, configurable by the user via the user settings.

14.2.10 NorDig Record Lists functionality

This NorDig Broadcast Record List (BRL) is optional for NorDig IRDs/PVRs to support, but if supported then all specified requirements for this NorDig Broadcast Record List feature in this document (recording, playback, management, presentation etc) shall be supported.

14.2.10.1 Recording capacity and disk management for Record Lists

For the avoidance of doubt, there are no additional requirements on recording capacity and disk space management specific to Broadcast Record List.

14.2.10.2 Broadcast Record List Entry Point

NorDig PVR supporting BRL shall provide a static entry point for displaying the available broadcast record lists for the user, e.g. through a native User Interface menu.

14.2.10.3 Presentation of Broadcast Record Lists

NorDig PVR supporting BRL shall have a means to present all Broadcast Record Lists in the default broadcast record list group (see section 12.9.6). NorDig PVR supporting BRL shall not present broadcast record lists from groups with a different root unless specifically recognised.

NorDig PVR supporting BRL shall only display broadcast record lists that are:

- included in the last received version of the metadata, and
- lists to which the user is currently subscribed, even when that list is no longer in the metadata, subject to the rules in 14.3.20.10.

It is possible that the metadata associated with a broadcast record list will change from time to time. When presenting broadcast record lists, the NorDig PVR supporting BRL shall always present the last received metadata. The NorDig PVR supporting BRL shall present at least the title and synopsis of each broadcast record list.

14.2.10.4 Broadcast Record List Subscription and Un-subscription

Users shall be able to subscribe to any broadcast record list (as profiled by section 14.2.10.3) and unsubscribe from any previously subscribed broadcast record list. Lists that are currently subscribed to shall be identified.

14.2.10.5 Presentation of Future scheduled BRL Recordings

The NorDig PVR supporting BRL should mark events in ESG and EPG that are booked/schedule to be recorded in the future that is part of any active Records Lists the PVR currently subscribed to.

14.2.10.6 Presentation of Acquired BRL Recordings

The NorDig PVR supporting BRL shall have a means to present a list of available recordings acquired using the broadcast record list functionality. The NorDig PVR supporting BRL shall have a means to present the title and synopsis for all such recordings. It is strongly recommended that NorDig PVR supporting BRL indicate to the user the subscribed broadcast record list(s) in which the acquired event was contained at the time of recording.

The user should be able to list the BRL recordings as:

- only all recordings of a specific Record List
- only all recordings from a BRL group

To avoid confusing viewers since for example BRL recordings may automatically be deleted (via expiry date) or embargoed, a PVR may have to different entry points for listing manual set (single or series) recordings compared to BRL recordings.

If the event has an expiry time, information regarding expiry of that recording shall be available. Recordings that have passed their mandatory expiry time (see 14.2.10.9) shall be clearly identified as expired and shall not be playable.

If the event has an embargo time (see 14.2.10.8), information regarding the embargo time shall be available, unless the embargo time has passed.

14.2.10.7 Limitations for External Media

In addition to any content management signalling and what is specified in NorDig section 14.2.7, storage of broadcast record list content to optical or other removable media shall be permissible provided that:

- any embargo time has passed and
- the content is not signalled with a mandatory expiry time

14.2.10.8 Management of Embargoed Content

For content with ActivationTime, until this date and time is reached the recorded content shall not be playable although associated metadata (synopsis etc.) may be displayed if required.

The NorDig PVR supporting BRL shall use the broadcast time as the underlying timebase to determine whether the embargo time has passed.

For acquired recordings with ActivationTime that are (or have been) listed in multiple Record Lists that the PVR is subscribing to, the one with the latest ActivationTime shall be used for the embargo.

14.2.10.9 Management of Content Expiry

For recorded content initiated by the Broadcast Record Lists and which includes a ExpiresTime element, (applicable for both “visible” scheduled events in EIT and for “non-visible” off-scheduled events), the ExpiresTime shall define the date and time after which the associated instance of the content shall no longer be playable by the user (ie recording shall be deleted), persistent memory used for the recording shall be released and the recorded event shall no longer be listed for the user be among available recordings.

The NorDig PVR supporting BRL shall be able to display the time of when the recorded content will expire, either in absolute time or in relative time (like “tomorrow”).

The NorDig PVR supporting BRL shall use the broadcast time as the underlying timebase to determine whether the expiry time has passed.

For acquired recordings with ExpiresTime that are (or have been) listed in multiple Record Lists that the PVR is subscribing to, the one with the earliest ExpiresTime shall be used to determine when the content shall no longer be playable by the user.

14.3 PVR Recording

14.3.1 General PVR recording

The NorDig PVR shall as a minimum support recording up to 20 Mbps per (SD) service and shall as a minimum support recording up to 30 Mbps per (HD) service. The NorDig PVR shall be able to record for at least 60 minutes with the above transmission figures.

The NorDig PVR shall be able to record all supported service types (TV, radio etc) and its components (as described in 14.3.9).

On-screen informational messages or menus generated by the NorDig PVR shall not be recorded with the programme content.

14.3.2 ESG/EPG recording programming

The NorDig PVR shall make it possible for the user to select individual events and series to be recorded from the ESG or EPG display (based on information from EIT data).

The NorDig PVR shall be able to make a booking from the ESG/EPG and later record this event both for events that do not include any CRID (i.e. only based on service and event_id) and events that include CRID's.

The selected event(s) for recording shall be marked as selected for recording on the ESG and EPG display.

If the user selects an event for recording from the ESG/EPG which has the same programme CRID value as an earlier recording within the NorDig PVR list of recordings, the NorDig PVR shall inform the user at the time of booking that this new selected event might already have been recorded and offer the option for the user to record anyway or not (1). The NorDig PVR should display information about this earlier recording (like the event name, date of recording and description).

14.3.3 Series recording

All events that have the same series CRID belongs to the same Series. An individual event inside a Series is referenced here as an Episode. (For definition of CRID see section 12.4.6.2).

The NorDig PVR shall be able to record a complete Series via the CRID.

The NorDig PVR shall store and track series CRIDs that are programmed for recording for up to 91 days between occurrences in EIT schedule. To allow broadcasters to reuse a series CRID for a different editorial concept, the NorDig PVR shall discard any series CRIDs not seen in EIT for 91 days.

The display of programmes selected for recording shall include an indication if the programme is included as a consequence of being one of a series.

The IRD should be aware that the default authority may be changed over time (for example a service might have default authority added in SDT), the NorDig PVR should automatically update its stored default authorities (not only during installation).

14.3.3.1 Series, record all episodes

The NorDig PVR shall support recording of all episodes of a specific series via series CRID's in the broadcast.

It shall be possible from ESG/EPG to program the NorDig PVR to record a series of events. The NorDig PVR shall indicate in the ESG/EPG that an event is part of a series. The NorDig PVR shall, if the user selects to record the event that belongs to a series, request the user what to record:

1. Only the single event selected.
2. Several or All events (episodes) of the series

14.3.3.2 Series, record limited number of episodes for a series

The NorDig PVR should support recording of a (limited) number of episodes of a specific series via series tagging in the broadcast. The limitation should either be a period of time or a number of episodes.

14.3.3.3 Series, only one instance/copy of each episode

The NorDig PVR should support the feature to only record one instance/copy of each episode in a series for series recording (to handle re-runs).

14.3.4 Split recordings

A programme may consist of multiple EIT events within the same service or over several services. For example, a film might be divided into two parts/blocks interrupted by a news programme in the middle (see Figure 14.1 A) or a longer sport event might be split into several parts/blocks over several services, (see Figure 14.1 B).

Signalling carried in the SI allows the PVR to identify and record all the events containing the parts of a single programme. A “split programme” is a single piece of content which comprises of two or more EIT events having the same CRID and IMI value with the gap from the scheduled end time (start_time plus duration) to the scheduled start time of any two of those events is less than 3 hours (see section 12.4.5).

The NorDig PVR shall consider a split programme to be segments of a single item of content. When selecting a split programme for recording, the NorDig PVR shall select and record all constituent events so that the complete programme content is recorded.

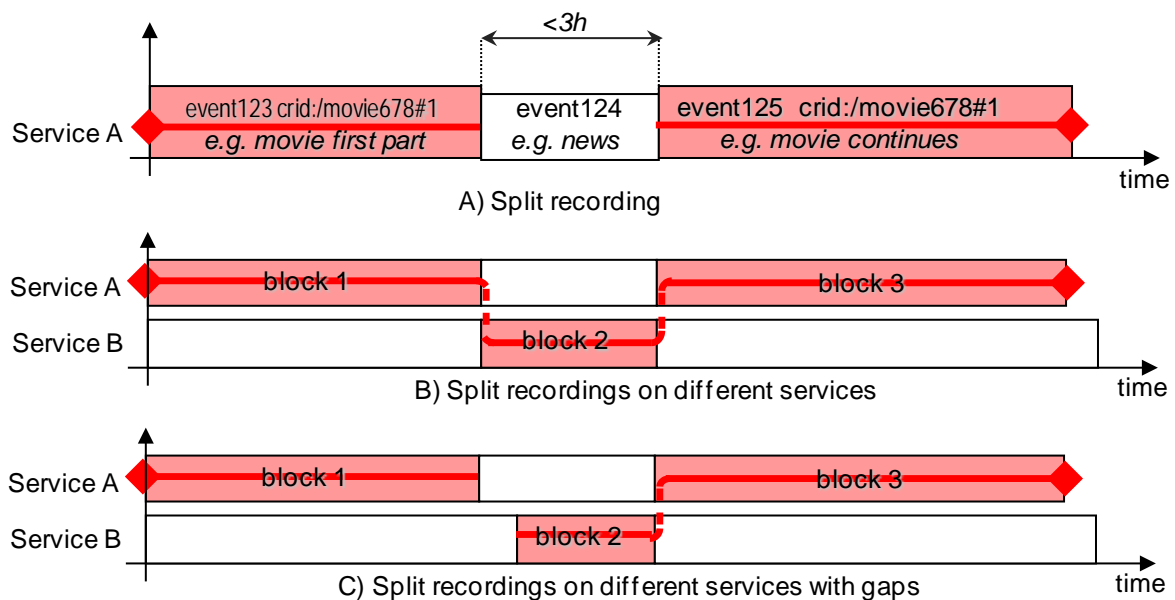

Figure 14.1 (Illustration) Handling of split recordings for the NorDig PVR. Split programme events (events with the same CRID value that are broadcast close in time to each others) shall be recorded with one and the same programming by the NorDig PVR.

- A) max gap time between events with the same programme CRID value that shall still be treated to belong to the same programme for recording.
- B) Split programme over several services.
- C) Split programme with gap and over several services

There are cases where a NorDig PVR may during the time of programming a recording only see a single event with the booked CRID and IMI combination (for example initially only the first part/block of the split programme has so far been included in the EIT). The NorDig PVR shall continue to monitor the EIT for additional events with the same CRID and IMI combination and include them to the selected recording.

In case of overlap between the split events and if the NorDig PVR has limitation in recording capacity when back-to-back recording, then the NorDig PVR shall first finalise recording of the first part/event of the split programme (according to the events start time and duration) before starting recording the next part of the split programme, This is the same behaviour as back-to-back recordings.

During the lifecycle of EIT schedule broadcasters may change programmes from split to single or vice versa.

In the NorDig PVR split recordings shall clearly be marked in the list of recordings as constituent parts belonging to the same programme, for example as one and the same entity or similar (1). It shall be enough to select only one entity from the file list of recording to get a playback of the complete programme (including all its all constituent events).

14.3.5 Recommended events

When the event selected has one or more recommendation(s) associated with it (signalled from original event with `crid_type 0x03`), the NorDig PVR should offer the option to record the recommendations (programme or series) as well as the selected programme or series.

Once selected, the appropriate recommended event(s) shall also be marked as selected to be recorded on the EPG display.

The recommended event(s) may also have recommendation(s) of its own. When user chooses to select to include the recommendation(s) into the recording, the NorDig PVR shall not include more than the original event's recommendation(s) (i.e. the NorDig PVR shall not follow more than the original event's initial recommendation and a recommendation should not be used to create a linked list of events to be recorded).

14.3.6 Alternative instance

When scheduled recordings overlap, the NorDig PVR should use the alternate instance information (1), when provided, to record one or more of the programmes at their alternate times thereby minimising the conflict, subject to any device limitations (e.g. available space).

Where a programme is repeated in its entirety a broadcaster may assign the same programme CRID to both EIT events. The NorDig PVR should detect an alternative instance of a programme (as when two events has same programme CRID). This can be used to assist in resolution of booking conflicts. Where alternate instances belong to the same series this allows the NorDig PVR to only record a single showing of each episode, usually the first.

14.3.7 Accurate Recording

The NorDig PVR shall determine the timing of the recording through monitoring of the EIT schedule and EIT present/following information.

The NorDig PVR shall record at least for the duration where the event ID in the EIT present table matches the event ID of the event selected from the EIT schedule to a precision of 10 Seconds, unless there is a conflict with another recording event.

The NorDig PVR may monitor the running status of the event in EIT present table and record only that part where the running status is set as running. (Note as specified in DVB SI Guidelines TR101 211 [28], 'undefined' running status in EIT present table shall treat the present event as running).

Where the Event ID is signalled in EIT present table early (in advance of the schedule start_time) the NorDig PVR shall start recording. As a minimum the NorDig PVR shall handle early starts of at least 10 minutes, provided there are no other recordings in progress.

The NorDig PVR shall monitor the EIT schedule and EIT present/following for updates to the start time and duration such that any event will be captured should the schedule be updated no later than 2 minutes prior to the current scheduled time of broadcast.

Where the Event ID does not appear within EITp/f (in neither the present nor following tables) within the expected schedule time and duration the NorDig PVR should record according to the scheduled start time and duration. If the event id appears in the EIT following table at the scheduled start time, it means that the event is delayed and the NorDig PVR should wait with the start of the recording until the event ID appears in the EIT present table.

The duration of the recording shall be changed even if the EITp/f is updated after the start time has elapsed, until the event is no longer present in the EIT present table.

If the NorDig PVR starts to record at the expected scheduled start time even if the event does not appear within EITp/f, the recording shall be considered as incomplete.

Where there is a loss of signal or EIT present table is no longer being received, the NorDig PVR will continue to record at least until the end time of the event (defined by start_time plus duration) in the last received EITp/f. If the signal is restored the NorDig PVR will continue to record according to its normal operation.

In standby mode (where the NorDig PVR IRD is not decoding any transport stream) the NorDig PVR shall have the capability to power on automatically twice per day to update the EIT and scheduled recordings. There may be an option to amend the time of power on or to switch off the facility as a user option, but factory default for this shall be that it is on.

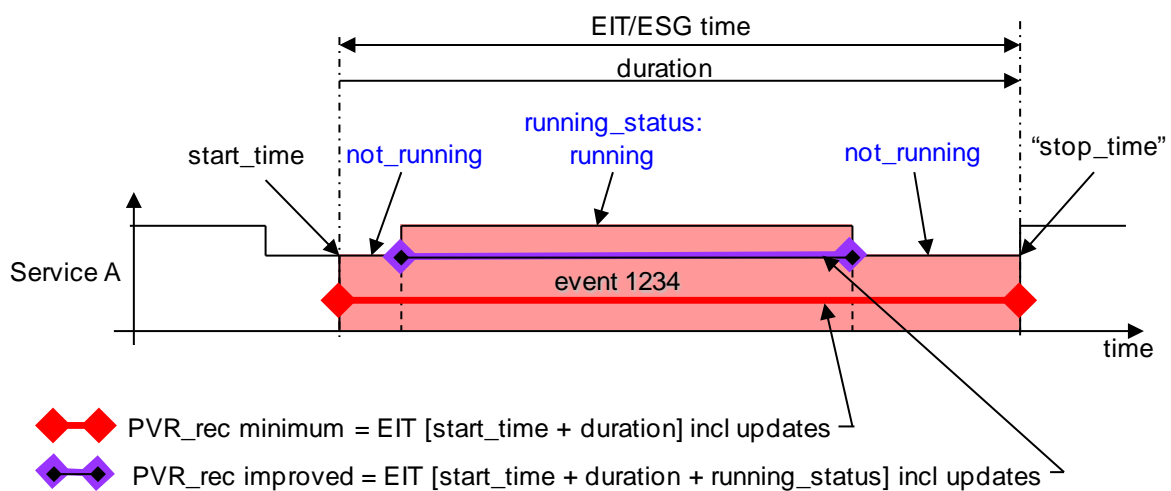

Figure 14.2 (Illustration) Handling of accurate recording. In red the minimum requirement, record only using as long as event is present in EIT present section table. In purple the improved version, via using event is present in EIT present sections and running status is “running”.

14.3.8 Simultaneous recording

The NorDig PVRs shall be able to record one service while viewing another, independently even if the services are on different transport streams.

The NorDig PVR should be able to record a background service (that is not viewed) at the same time as timeshift record the viewing service, independently if the services are on different transport streams.

14.3.9 Full service recording

The NorDig PVR shall be able (factory default) for all recordings to include all supported components/PIDs for the basic TV viewing listed in the PMT of the recorded service (e.g. video, audio 1, audio 2, EBU Teletext, DVB subtitles, PCR etc), excluding any HbbTV or other API related streams (Any HbbTV related streams are optional to be included in the recording).

Note: For a NorDig PVR using removable media formats (such as DVD or Blu-ray) for recordings, such devices shall include all supported components/PIDs for that format and any subtitling shall (according to the user preference settings) be burnt in to the video or converted into a supported subtitling format. Observe the limitation specified above for removable media.

14.3.10 Trailer booking/Promotional Linking (optional)

14.3.10.1 General

The trailer booking (or promotional linking) is typically used during a promotion trailer to give the viewer the opportunity to easy and directly program/book their PVR to record the event the trailer is referring to.

The NorDig PVR supporting Trailer booking shall have the ability to decode and process Related Content Signalling as defined in chapter 12.8 (RCT) and 12.6.11 (related content descriptor) in order to drive broadcast-triggered native or API based applications typical example Trailer Booking (Promotional Linking). (This refers to that in the future other usage of the RCT may be added).

The decoding and display of information referenced by descriptors carried in the RCT shall be supported as defined in chapter 12.8.3 (short event descriptor in RCT) and 12.8.4 (image icon descriptor).

The event name shall be displayed together with any promotional text at time of booking (when displaying the Trailer booking menu on screen). At the time of booking, the NorDig PVR shall not include any event description text from the short event descriptor.

The short event descriptor's event name (from the RCT or EIT) shall be used to provide information about the event in the PVR's list of booked recordings. The short event descriptor's event description text from EIT may also be used in the PVR's list of booked recordings to provide more information.

The NorDig PVR supporting Trailer booking shall display all combinations of the broadcast icon and default icon in accordance with chapter 14.3.10.2 below.

The NorDig PVR supporting Trailer booking shall display all combinations of the broadcast icon and default icon in accordance with chapter 14.3.10.2 below.

14.3.10.2 Icon activation and deactivation

The NorDig PVR supporting Trailer booking shall display and remove from display the icon according to following rules:

- a new RCT table (version number change) with a link count greater than zero shall cause the icon to appear
- a new RCT table (version number change) with a link count equal to zero shall cause the icon to disappear.

The display/removal of the on-screen icon and allocation/release of remote key for trailer booking shall occur within 2 seconds of the RCT table changes described above.

Note: "link count" is the number of links the receiver can understand and use, not the total links in the RCT. For example, a receiver without an IP connection may ignore all links that reference online content, hence, such a link by itself would not cause an icon to pop-up on screen.

When the NorDig PVR supporting Trailer booking is in normal TV viewing mode and a promotional link becomes active the green button on the remote control shall temporary be redirected away from its other

usage (like HbbTV application). As soon the trailer link is no longer active, the trailer booking key shall be released.

Exceptions: If user has entered into another TV mode (e.g. entered Teletext page, HbbTV application, menu mode or similar modes) before the promotional link becomes active, the green button shall not be redirected. If user enters into another TV mode (e.g. entered Teletext page, MHP application, menu mode or similar modes) during an active promotional link, the green button shall be released from trailer booking usage. If the user re-enters back to normal TV viewing mode during an active promotional link, the NorDig PVR should redirect trailer booking key (green button) and display the trailer booking icon.

Normal TV viewing mode refers here to when user has not actively entered Teletext page viewing mode, “opened” HbbTV application, entered menu or similar modes. (Observe that the broadcaster may control in the broadcast change of HbbTV application state and allocation of remote keys. Broadcaster should be aware that trailer booking may not work properly if used keys for trailer booking on remote control are allocated for the HbbTV application).

An icon may be deactivated by pressing the receiver’s usual cancel key e.g. “back”, “TV”, .

It should be possible in the user preference setting to pre-define a default alternative if NorDig PVR supporting Trailer booking shall be active and react to broadcasted Trailer booking messages (in RCT) or not. (Factory default setting shall be on (active) for trailer booking).

14.3.10.3 Default Icon

For NorDig PVR supporting Trailer booking, the icon that is displayed on screen during an active link can be from a receiver inbuilt icon or a broadcaster signalling icon. ETSI TS 102 323 [34] in Link info structure regarding default icon signalling defines four combinations of how these icons can be used: all combinations may be used.

The default icon shall be a representation of the green button on the remote control – so the icon shall look like a green button.

The popup shall also contain a text in local language – telling the user to press the green button to program/book the described event (example: ‘Press Green To Book’)

Manufacturers should be aware that the green button on the remote control will be used to select the trailer booking and take account of other on-screen objects (such as HbbTV applications).



Figure 14.3 Illustrative example of a trailer booking default icon

Note: For services that have both HbbTV application and trailer booking, a Hybrid IRD will typically allocate the green button for HbbTV usage and prevent this button for trailer booking control unless the HbbTV application have released the green button for its usage. It is up to the broadcaster to control and release the green button from HbbTV application usage to enable Hybrid IRD to use the green button during broadcast of trailer booking.

14.3.10.4 Image icon position

The NorDig PVR supporting Trailer booking shall use the signalled position information to position the icon if no native UserInterface items are being displayed. If native UserInterface items (like zapper banner, menu) or subtitling are displayed simultaneous as image icon, then the signalled position information should be used as a guide.

14.3.10.5 Subtitling and display of image icon

14.3.10.5.1 Default Icon

The NorDig PVR supporting Trailer booking shall be able to continue decode and display subtitling (EBU Teletext subtitling or DVB Subtitling, see chapter 7) also when displaying the image icon. (When the IRD is displaying the trailer booking menu, NorDig PVR should continue displaying subtitling).

14.3.11 Back-to-back recording

The NorDig PVR shall be able to record back-to-back events both on same and on different services.

Note: Back-to-back events refer to two events that immediately follow each other, i.e. the following event start_time is immediately after the previous events stop time,(start_time plus duration), see figure below.

For overlapping events see 14.3.16.2. If the first event has same or higher priority as the second event (see 14.3.16.2) and the first event will overrun, if the NorDig PVR has limitation in recording capacity, it shall first finalise recording of the first event (including its overrun part) before starting recording the next event. The overrun shall be treated as the more important part of the events, see figure below.

If the NorDig PVR has been set to add additional recording time (“safe margins”) before and after recorded events’ start and stop time, any overlapping “safe margins” between the back-to-back events shall be removed (if the NorDig PVR has limitation in recording capacity for this), see figure below.

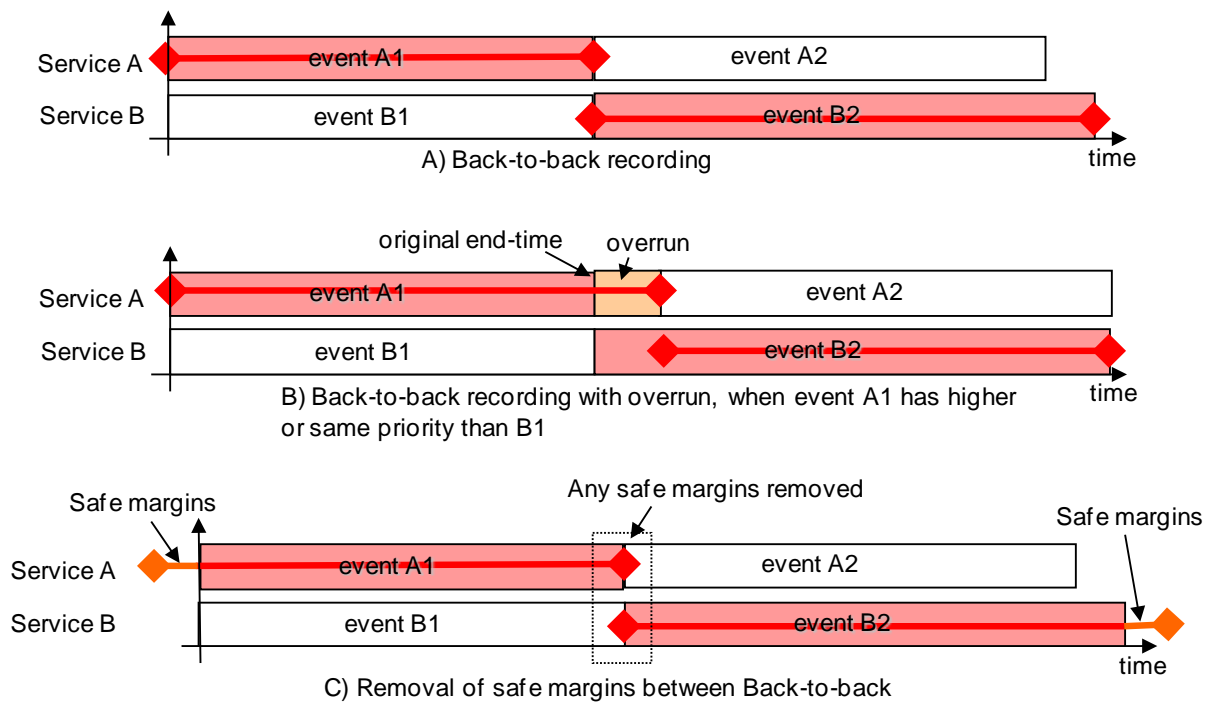

Figure 14.4 (Illustration) Handling back-to back recordings

14.3.12 Timeshift recording

The NorDig PVR shall be able to pause or timeshift live TV for at least 60 minutes. It should be possible to save time-shifted events into the PVR list of recordings.

14.3.13 Late Recording

The NorDig PVR should support a continuous time-shift buffer for late catch-up recording. If supported then the NorDig PVR (based on Hard Disk Drive) shall be able to disable the continuous time-shift buffer in settings. It should be possible to record a complete event after the event has started including any portion already in the time-shift buffer.

A late recording is when the user programs the PVR to record an event after it has started (according to the events start_time and that it is within EIT present table). If the time-shift buffer includes the start of the event, the recording is treated to be a complete late recording. If the time-shift buffer does not include the start of the event or if the PVR does not have any time-shift buffer, the recording is treated to be an incomplete late recording.

For incomplete late recording the NorDig PVR shall check if there is an alternative instance available within the EIT data (i.e. an event with same CRID value). If an alternative instance of the event is found within the EIT data, the NorDig PVR should offer for the user to automatically replace the incomplete recording later with a complete recording using the alternative instance (the NorDig PVR should however anyway first finalise the rest of the present incomplete recording). If there is conflict because of the alternative instance, the NorDig PVR shall not use alternative instance, it shall then keep the late incomplete recording.

If there is no alternative instance information available at the time of recording, the NorDig PVR shall monitor EIT tables for alternative instance until incomplete recording is removed from the NorDig PVR.

The Late recording should not include recordings from previous event, even if the continuous time-shift buffer did include that at the time of programming.

The manufacture should inform the user in the NorDig PVR's manual about limitation in late recording, for example it could typically be that it is only possible to record/store as long to back in time for one service as the service has been selected for viewing or as long time as the timeshift buffer is.

14.3.14 Manual recording

The NorDig PVR shall make it possible for the viewer to set a manual recording, without using the EPG/ESG/EIT data, by setting the service, start-time and end-time (or duration).

The time and date for the user when programming shall be the local time, including any offset, at the time of recording according to the IRD's settings, and not the local time at the time of programming. This means that if there is a change in local time offset (e.g. change in daylight-saving time) between the time of programming and the time of recording, the time and date shall refer to the new local time at the time of recording.

It should be possible to set weakly repeated manual recording (like every Monday 19:00:00 to 20:00:00 or every weekday between 12:00:00 to 12:15:00)

14.3.15 One touch recording (OTR)

The NorDig PVR shall include a direct recording setting as a One-touch recording (OTR) function which allows the user to start a recording, while watching live TV, with one button press on the remote control.

This One-touch recording shall not be delayed by further requests for user interaction unless to proceed would affect a recording that is either already underway or scheduled to start before the end of the OTR recording.

The duration of the One-touch recording operation shall be based on either a pre-set time or current viewed event.

In addition, the NorDig PVR may have another setting alternative that when pressing the OTR button the NorDig PVR asks for user confirmation whether the direct recording shall be based on current viewed event (from EIT data) or on a pre-set time.

14.3.16 Automatic conflict handling

A conflict arises when the NorDig PVR is restricted to perform a recording due to limitation in recording capacity.

14.3.16.1 Conflict during the time of programming a (individual, series or manual) recording

If a conflict is detected it shall be indicated immediately to the user, together with details of the cause, so that the user can take appropriate action.

When programming a recording which comes in conflict with an earlier programmed recording and when the NorDig PVR can detect an alternative instance in one or both of them, the NorDig PVR shall either automatically re-program one of the to the alternative instance or propose that viewer solve the conflict by moving one of the recordings to the alternative instance and asking for confirmation.

14.3.16.2 Conflict occurring after the time of programming recording(s)

If the NorDig PVR has a number of active programmed series recordings and if there occurs a request of more simultaneous recordings than the NorDig PVR is capable of handling, the NorDig PVR shall be able to handle this without user confirmation at the time of actual recording, i.e. the IRD may inform of the conflict via the OSD but shall automatically solve the conflict at the time of actual recording if the user does not manually change the conflict handling. Any information on OSD about conflict shall not be included in recording and shall have a time-out if no user reaction. All requests for user confirmation shall be done during the time of programming or during the setting of user preferences.

The conflict(s) shall be solved with higher priority recordings having preference before recordings with a lower priority. It is up to the NorDig PVR manufacture to define the PVR's priority list, however it may typically be as prioritised in Table 14.1. Conflict(s) of recording with same priority level shall also be automatically solved (at least one of them shall be recorded), but it is up to the NorDig PVR manufacture to define a mechanism. The NorDig PVR should offer for the user the ability to change the conflict priority in the user preferences.

Factory default Priority list of handling recording conflict in NorDig PVR

Priority	Recording type
1 (high)	Manual single recordings
2	Manual repeated recordings
3	Individual event recording (single shot) without alternative instance
4	Individual event recording (single shot) with alternative instance
5	Series recordings without alternative instance
6	Series recordings with alternative instance
7	Broadcast record list recordings without alternative instance
8	Broadcast record list recordings with alternative instance
9 (low)	Automatic Keyword recordings

Table 14.1(Illustration) Priority list for PVR

If a conflict occurs in a partially or completely overlapping recording after the time of programming the NorDig PVR shall prioritise the recording with the highest priority, as illustrated in figures below. For conflict with events with same priority, the NorDig PVR shall first finalise the first recording (including any late over-run) before starting with next. (See also back-to-back recording).

Any recording that may only be partially recorded (incomplete) due to overlapping of other recordings (including late over-run) should be recorded anyway (see Failed and incomplete recordings).

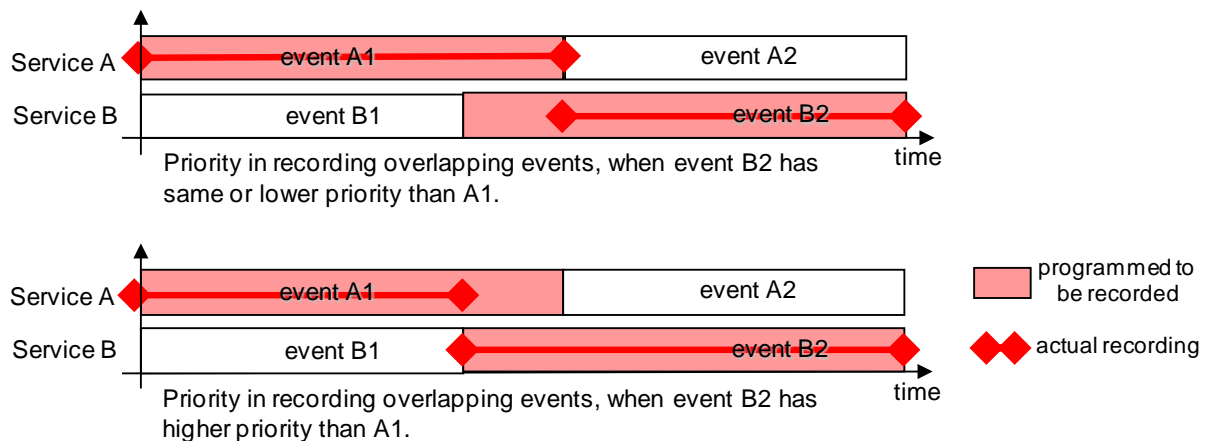

Figure 14.5 Examples of conflict handling when PVR identifies events that have different priority

14.3.17 Maximum length of recordings

If there is a failure within the transmission of the EIT and other transmission errors, the NorDig PVR shall stop recording 4 hours after scheduled duration of the event has passed (even if the event still appears in EIT present table).

For events that have a duration that is longer than 8 hours, the NorDig PVR may stop recording after 8 hours.

14.3.18 Recording of recently removed recordings

Recently removed programme CRID recordings are here defined as recordings that included programme CRID data and that have been deleted and there has not passed 91 days from its recorded start_time or 31 days from its deletion time (whichever occurs last of these two).

For already booked series recordings, the NorDig PVR should not re-acquire recently removed programme CRID recordings (identified via match of programme CRID). After the time has passed for the recently removed programme CRID recording, the NorDig PVR shall re-acquire the event.

When the viewer/user during programming a recording, i.e. making a booking, (manual or series) and viewer/user selects an event or series within the received EIT data which contain an event that is a recently deleted programme CRID recording (identified via match of programme CRID), the NorDig PVR should prompt the viewer that the event has been recorded and recently deleted by the user and ask for confirmation to continue booking it for recording (i.e. if viewer confirms re-acquire the content, the NorDig PVR shall be able to record the event).

14.3.19 Recording of parallel broadcast and simulcast

Some services and events are parallel broadcasted in multiple versions. In this context a parallel broadcast of same programme event is identified that all service's events have the same programme_CRID. Examples of parallel broadcasts are services with same national content but with different regional content and services with same content but with different resolution i.e. SD and HD simulcast broadcast services. The NorDig IRD that has been programmed to record an event with a specific programme_crid or series_crid which a programme_crid is part of, shall only record one instance of the event from one of the services when the event is parallel broadcasted over several services at the same time.

The NorDig PVR should, by factory default, prioritise recording of the event from HD service over the SD service during SD and HD simulcast broadcast of the same programme event. (See SI chapter 12 for more details of the service types for SD and HD services).

The NorDig PVR may allow an end user to change the user preference setting regarding or during the time of programming offer the end user to choose which service type has a recording priority during SD and HD simulcast broadcast.

14.3.20 NorDig Record Lists recording functionality

This NorDig Broadcast Record List is optional for NorDig IRDs/PVRs to support, but if supported then all requirements for this NorDig Broadcast Record List feature shall be supported.

14.3.20.1 Management of Content Grouping

A NorDig PVR supporting BRL shall receive and manage all TV-Anytime groups that are part of the Record List metadata service.

14.3.20.2 Content Acquisition

A NorDig PVR supporting BRL shall automatically acquire, without user intervention, all events that correspond to PushDownloadProgram fragments which are, members of Record List groups to which the user has subscribed.

Events requiring acquisition from the schedule shall be acquired according to the current recording acquisition rules.

A PushDownloadProgram CRID that the program CRID is not yet part of the current EIT, shall only be valid for recording up to 91 days from the last Broadcast Record List it has been published (after that the NorDig PVR shall remove that event from its recording schedule).

A PushDownloadProgram ProgramURL to an event_id of a specific service that is not yet part of the current EIT, shall only be valid for recording up to 10 days from the last Broadcast Record List it has been published (after that the NorDig PVR shall remove that event from its recording schedule).

14.3.20.3 Recording List Hierarchies

When booking a record list, the NorDig PVR supporting BRL shall book all children of that record list see 12.9.5. There is no requirement for the NorDig PVR to detect loops in any group hierarchy.

14.3.20.4 Management of Content Versioning

If the version of a content that has already been acquired is seen to change, then NorDig PVR supporting BRL should re-acquire the event, replacing the old version in storage.

14.3.20.5 Metadata Changes Post Broadcast

A NorDig PVR supporting BRL may monitor the metadata for changes up to 7 days from the original broadcast of the content, or up to the event's availability to the viewer (if signaled). If a change is detected to an already acquired event, then the most recently transmitted version should be applied.

14.3.20.6 Unresolvable PushDownloadPrograms

If a CRID signalled in a PushDownloadProgram cannot be resolved to an EIT event, the NorDig PVR supporting BRL shall continue attempts to resolve the signalled CRID according to Section 8.7.2 rules.

14.3.20.7 Use of Program Information

In the case where information is available both from EIT and programme information table, the programme information table shall be used.

14.3.20.8 Recording Conflicts

Any user initiated activity in the NorDig PVR supporting BRL shall take precedence over recording of Broadcast Record List events.

It is strongly recommended that, in the case where a broadcast record list event could not be acquired due to a lack of resources, alternate instances of the event be located and rebooked.

The behaviour defined in this subsection may be modified through previously set user preferences.

14.3.20.9 Broadcast Record List Removal

A broadcast record list that has been subscribed to shall be automatically unsubscribed from when it has not been received in the broadcast metadata for 91 days.

14.3.20.10 Broadcast Record List Updates

A NorDig PVR supporting BRL shall within 10 minutes act upon updates to the received metadata.

14.4 Playback

14.4.1 General

The NorDig PVR shall be able to playback recordings of all supported service types (TV, radio etc) and all belonging components/PIDs (as described in 14.4.5).

Only the service related interactive applications from the current viewed service (live or playback) are required to be active, this means that during playback all interactive applications from the live service in the background may be terminated.

14.4.2 Replay/Playback – trick modes

The NorDig PVR **shall** support the following trick modes during playback of recorded events (incl time-shift) for all supported video formats/codecs:

- **Play** (playback at normal speed)
- **Pause**
- **Stop** (stop may be combined with pause, but must enable an easy way to stop playback and return to list of recordings and live viewing mode)
- **Fast forward** and shall support fast forward at minimum 3 different speeds, (like x3, x6, x15 and x30).
- **Fast reverse** and should support fast reverse at minimum 3 different speeds, (like x3, x6, x15 and x30).

The audio may be muted during trick modes (except during normal playback). The subtitling (EBU Teletext subtitling or DVB Subtitling) and other event based data application may be skipped during trick modes (except during normal playback). The NorDig PVR should make use of the AU_information according to ETSI TS 101 154 [28], if that information is available in the recorded video stream. The slower fast forward and fast reverse modes should be smoother rather than trying to keep the exact selected trick mode speed.

The NorDig PVR should support the following trick modes during playback of recorded events (incl time-shift) for all supported video formats/codecs:

- **Slow forward** (like x1/2 and x1/4 of the normal speed)
- **Slow reverse** (like x1/2 and x1/4 of the normal speed)
- **Next**, go to next recorded event within same series (i.e. to a event within same series with a newer date or “episode_id”, if the current event belongs to a series and the NorDig PVR has recorded several events) otherwise go to next recording within the list of recordings.
- **Previous**, go to a previous recorded event within same series (i.e. to a event within same series with an older date or lower episode_id, if the current event belongs to a series and the NorDig PVR has recorded several events) otherwise go to previous recording within the list of recordings.
- **Jump**, go to a specific time in the recording and/or fast jump a manufacture defined fixed time (e.g. 4 min forward).

The NorDig PVR should be able to insert indexes into the recordings to enable fast access to different parts of the recording.

14.4.3 Relative Synchronisation

The NorDig PVRs shall not introduce more relative delay (reduced “lipsync”) during playback between the audio, video and other PES packetised components (like subtitling) compared to decoding of live content, measured 5s or later after start of normal playback (see chapter 6.1.2.1 and 7).

After using trick mode the relative delay shall meet the requirements within 5s after resuming back to normal playback speed.

14.4.4 Simultaneous recording and playback

The NorDig PVR shall be able to record and playback simultaneously. It shall be possible to record one service from the live transmissions while playback another earlier recording.

The user shall be also able to start the playback of a recording for which the recording has not yet completed (“chase playback”).

14.4.5 Full service playback

During playback of recorded content the user shall be able to perform the same full service selection as would have been possible during basic live viewing, such as select audio and/or subtitling language (if several components with same type are available), switch subtitling on or off, select audio format etc (with the limitation outlined in section 14.3.9). The basic live viewing refers to all streams excluding any HbbTV related streams. Dynamic changes in the services (such as a change of video aspect ratio or change of audio format) that occur during the recording shall be processed in the same way as during live viewing.

During playback the NorDig PVR shall be able to set the same control as during live viewing, for example blanking of video and muting of sound depending on the event’s parental rating values (see 14.3.2) and signal protection (HDCP) on its digital output interface (see 9.9.4). For cases where the information is coming from EIT data (like parental rating descriptor), the playback shall at least act on the EIT signalling at the start of the recording (see 15.2.1). For the cases where the information is coming from PMT or the elementary streams (like signal protection and aspect ratio), the playback shall perform the same as live viewing and following any changes therein (i.e. PMT and elementary stream header information shall be stored and processed during playback).

14.4.6 Resume Playback

When resuming back to a partially viewed recording, the NorDig PVR should resume back to the point of the recording (or a moment before that point) where the previous playback was stopped.

It should be possible to set index points of interest during playback, where later playback may be jumped to.

14.4.7 NorDig Record Lists management and playback functionality

The requirement for playback of NorDig Record Lists recordings are the same as for playback for other types of NorDig recordings (manual recordings, series recordings), see above. *(In addition there are also requirements for embargo and expiry of recordings, see 14.2.10.8 and 14.2.10.9).*

15 IRD System Software and API

15.1 *NorDig Basic*

The NorDig Basic TV IRD shall have a system software for interpretation and handling of the active service information and control of the local hardware/software.

15.2 *NorDig Hybrid*

The NorDig Hybrid IRD shall support all mandatory features and requirements of HbbTV v1.5 as specified in ETSI TS 102 796 v1.2.1 specification [30].

The NorDig Hybrid IRD shall have a broadband interface in accordance with NorDig Section 8.3 (two-way interface).

The NorDig Hybrid IRD shall have HbbTV feature as enabled by default (see Section 16.3). It shall have a menu option to allow user to enable / disable the HbbTV feature as a whole and it should have a menu option to allow user to enable / disable the HbbTV feature service by service.

The implementation of the HbbTV in the NorDig Hybrid IRD shall be verified by the manufacturer, the verification testing is based on self testing by manufacturer (unless otherwise specified by the relevant network/Operator). Verification testing of the HbbTV parts of NorDig Hybrid shall (2) be based on HbbTV test specification [83] (1) plus the extra HbbTV test cases defined by NorDig, for more information see NorDig Test Plan.

NorDig mandates some of the requirements that are optional in HbbTV [30], this also means that relevant test cases in the HbbTV test specification [83] also have (2) to be performed successfully (for more information see NorDig Test Plan).

NorDig broadcast member may (2) request to get a copy of the manufacture's HbbTV Verification Test report with test results, before approving Hybrid IRD on the market.

Note 1: At the present time HbbTV test specification [83] is still under development and verification testing shall be made on latest available test specification for HbbTV v1.5 functionality, which in June 2014 refers to HbbTV test specification [83] that covers implement of the HbbTV specification v1.0 (ETSI TS 102 796 v1.1.1).

Note 2: Optional for NorDig IRD released before 1 July 2015.

Note: NorDig members will typically use Nordic and Irish languages in text strings in HbbTV and some cases use multiple languages within one and the same HbbTV application, observe that the NorDig Hybrid shall as stated in HbbTV specification [30] support all characters in these languages and multiple languages.

16 User Preferences

16.1 General

The user shall be able to store preference settings in persistent memory. All user preference settings listed below shall remain when changing service and when re-starting the IRD. The following user preferences shall be implemented in the NorDig IRD, unless it is stated below as optional (should) requirement. (See section 16.4 for factory default values).

16.2 User Preference Settings

16.2.1 General User Preference Settings

The user shall be able to select storable user preferences for following General related functions (see section 16.4 for factory default values):

- Service list as defined in section 13.2.
- Country setting based on country code [49] for pre-selection of the primary menu, primary audio language, primary subtitle language settings and channel list selection as defined in 12.2.9.3.
- Talking menus/Text-to-Speech preferences as defined in section 13.6.2, if this optional feature is supported by the IRD.
- SSU setting(s) to select whether system software upgrades are allowed or not and which alternative of SSU upgrade (automatic, manual...), see chapter 10 more details and 16.3 for factory default for this.
- HbbTV setting(s) for NorDig Hybrid as defined in section 15.2.

The following user preferences should be provided for NorDig IRDs:

- HDCP preferences as specified in sections 8.6.4.

16.2.2 Video User Preference Settings

The user shall be able to select storable user preferences for following video related functions (see chapter 16.4 for factory default values):

- Video display preferences as defined in section 5.
- HDMI Video preferences for Output video format, as set by the user:
 1. Automatic mode, based on use of E-EDID, as specified in section 8.6.2
 2. Fixed format, as specified in section 8.6.2

16.2.3 Audio User Preference Settings

The user shall be able to select storable user preferences for following audio related functions (see chapter 16.4 for factory default values):

- Primary and secondary audio language (see section 6.5.1).
- Audio Format between stereo or multi-channel for the digital outputs, when the outputs are equipped for multichannel audio (see section 6.3, 6.4, 6.5.2, 6.6 and 8.6.3).
- Audio Type between “Normal” and Supplementary Audio (see section 6.11 and 16.1.3.1)
- Audio delay value for the digital audio output (mandatory for NorDig STB with HDMI and/or S/PDIF output, optional/recommended for iDTV, see section 6.7 and 6.7.1).
- Audio output method for HDMI output, HDMI ARC and S/PDIF (if several alternatives is supported by the IRD), e.g. pass-through of native bitstream, decoded to PCM, transcoded to DTS and AC-3, (see section 6.2.2.3, 6.2.3.3, 8.5.3 and 8.6.3).
- Mixing level between the receiver mixed supplementary audio and “Normal” audio, (see section 6.10.3.5).

The following user preferences should be provided for NorDig IRDs:

- Clean Audio selection as specified in section 6.10.

16.2.3.1 Additional User Preference Settings for Supplementary Audio

The NorDig IRD should have user selection of Supplementary Audio preferences for between the different subvariants as; ‘Audio Description’, ‘Spoken Subtitles’ and ‘all types of Supplementary Audio’.

The user preference settings for enabled/disable default Supplementary audio shall be common for Broadcast mixed (1) and Receiver mixed alternatives.

The IRD should have additional setting for Receiver mixed alternative, which presents the Supplementary Audio on its own on the head-phones output interface, while the “normal” audio is presented on its own on the main audio output, see section 6.10.7.

The IRD may have additional setting for Receiver mixed alternative.

Note 1: This requirement for Broadcast mixed refers to when the audio stream is signalled as supplementary audio via visual impaired and/or via other supplementary signalling in AC-3/E-AC-3/AAC descriptor and/or supplementary audio descriptor. This means that for the case when the audio stream is signalled with ‘nar’ language code in ISO639 descriptor and no other supplementary signalling, IRD may have different settings for, for example via primary audio language preference setting to ‘narrative’.

16.2.4 Subtitling User Preference Settings

The user shall be able to select storable user preferences for following subtitling related functions:

- Primary and secondary subtitling language as defined in chapter 7.

16.3 Deletion of service lists

The IRD shall provide a function to remove all service lists (default and user defined); this function should not affect other parameters (e.g. user preferences).

Note. Removal of service list can be implemented as part of factory reset, see below.

16.4 Reset to factory mode

The IRD shall provide a function to reset all parameters to factory mode, thus removing all service lists, user preferences, etc. After reset, the IRD shall enter installation state.

The factory mode should be set to the following:

RF input DC power supply source for satellite front-end:	On
RF input DC power supply source for terrestrial front-end:	off (1)
RF-output preset channel:	Channel 43 (PAL-G) (2)
RF bypass gain	Disabled
Menu language:	equal to country settings
Audio (normal)	On (3)
Primary audio language:	equal to country settings
Audio; Supplementary Audio / Audio Description (visual impaired):	Off (4)
Audio format setting:	Stereo

Subtitling (normal):	On
Primary subtitling language:	as country settings
Subtitling; hard of hearing/hearing impaired:	Off
HbbTV Interactivity	On
HDMI Audio output	Automatic, using E-EDID information
HDMI Video output	Automatic using E-EDID information
HDCP	ON or as specified by the relevant network/ CA operator see section 8.6.4 (5)
SSU – mode	Semi-automatic (if supported, otherwise a mode that enables automatic search) (6)
PVR recording priority, SD vs HD	HD
Talking menus (Text-to-Speech), optional	Off
<p>Note 1: In the first time installation and resetting to factory default settings, the DC power supply shall be switched off. It is recommended that the receiver ask if the DC power supply is turned on in the first time installation and in the installation after resetting to factory settings, to speed up the initialisation procedure.</p> <p>Note 2: Applicable for IRDs with RF PAL modulator</p> <p>Note 3: Audio type 0x00 'Undefined'</p> <p>Note 4: Refers to all kinds of supplementary audio (Audio Description, Spoken Subtitling) and both distribution formats: Broadcast mixed and receiver mixing of visual impaired audio stream.</p> <p>Note 5: The IRD should provide an option to manually set the HDCP default to “ON” or “OFF”, see section 8.6.4.</p> <p>Note 6: Settings for SSU (System Software Update) may be implemented as one combined setting or several settings for different parts. Semi-Automic mode refers to Auto search enabled, Auto download enabled but Auto install disabled, see section 10.</p>	

Table 16.1 Factory default settings for IRDs

Annex A: NorDig Members and Acknowledgement

The NorDig group represents per June, 2014 the following broadcasters, operators and other companies in the Nordic countries and Eire:

1 NorDig Full Members

Denmark

Danmarks Radio (DR)
Stofa
TV2 Danmark A/S
YouSee A/S

Eire

Radio Telefís Éireann (RTE)

Finland

Digita OY
PlusTV OY
Yleisradio (YLE)

Norway

Norges Televisjon AS (NTV)
Norsk Rikskringkasting AS (NRK)
RiksTV AS
Telonor Broadcast Holding AS
TV 2 Norge AS

Sweden

Comhem AB
Sveriges Television AB (SVT)
Teracom AB
ElektronikBranschen

2 NorDig Associated Members

The NorDig group represents per June 2014 the following associated members:

LG Electronics
Vestel Elektronik Sanayi ve Ticaret A.S.

3 Acknowledgement and support

NorDig have had great support from a number of manufactures and other non-NorDig-member companies as technical expertise and with help to ensure updates of our specifications. NorDig would like to express our great appreciation to the following companies for their support in NorDig:

Dolby Europe Ltd
Samsung Electronics
Sony Europe Ltd
TP Vision
Toshiba

Annex B: Background and options for IRDs with a terrestrial front-end

1 Terminology and Definitions for Single Frequency Networks Performance Parameters

Although it might be believed that the delay spread of the channel can be assumed to stay within the length of the guard interval used, this is not always the case in practice. In single frequency networks there will normally be all sorts of delayed components and significant components having a delay far greater than the guard interval will often exist, although normally at a low but not insignificant level, and have a significant impact on the coverage area. In many cases delayed components will be significantly stronger than the earliest component.

In order to have good performance in single frequency networks it is therefore very important that:

1. the receiver is able to time synchronise in a quasi-optimum way in order to minimise the intersymbol interference that will exist when pre- and/or post echoes are longer than the guard interval.
2. the receiver is able to correctly equalise also in channels with echoes longer than the guard interval. It should be noted that the optimum way of frequency interpolation is dependent on the actual FFT time window position.

The required EPT depends on the system parameters and on the characteristics of the echoes inside and outside the guard interval, which determine the *criticality* of the channel (its frequency selectivity).

- For fixed reception, the Ricean channel (F_1 , see EN 300 744 [20]) is used for the main transmitter contribution. The *EPT* depends on the amplitude of the artificial echoes from the other transmitters, and can vary from $C/N/F$ (single transmitter, Ricean channel (F_1) for low artificial echoes to $C/N/P$ (single transmitter, Rayleigh channel (P_1), for high artificial echoes. The number and the delay of artificial echoes within the guard interval does not affect significantly the system performance, but their total power compared to the power of the main path has an important effect on the channel *criticality*. A parameter, K_A , has been identified as the “channel criticality due to artificial echoes” and is the ratio (in dB) between the power received from the main transmitter and the total power of the artificial echoes inside the interval of correct equalisation T_F . It should be noted that $K_A = 0$ dB corresponds to the most critical case.
- For portable reception, the channel (Rayleigh) is adopted for each transmitter contribution (natural echoes), and the computer simulations have indicated that *EPT* is not significantly affected by the presence of the other SFN transmitters (in fact the channel model is of Rayleigh type also with a single transmitter).

Neglecting other interference sources, the equivalent total available $C/(N+I)$ [dB] in a given location of the service area can be estimated by using formula (A.3).

$$\begin{aligned}
 W_i &= \begin{cases} \left(\frac{T_u + \tau}{T_u}\right)^2 & \text{if } -T_u \leq \tau \leq 0 \text{ \& } \tau \in T_F \\ 1 & \text{if } 0 < \tau \leq T_g \text{ \& } \tau \in T_F \\ \left(\frac{T_u - \tau + T_g}{T_u}\right)^2 & \text{if } T_g < \tau \leq T_u \text{ \& } \tau \in T_F \\ 0 & \text{otherwise} \end{cases} \\
 C &= \sum_i w_i C_i \\
 I &= \sum_i (1 - w_i) C_i
 \end{aligned} \tag{A.3}$$

where:

C_i is the power contribution from the i -th echo (natural or artificial) at the receiver input.

C is the total power of the effective useful signal.

I is the total effective interfering power.

w_i is the weighting coefficient for the i -th component.

T_F is the *interval* (i.e. not a numerical value) of correct equalisation. The theoretical maximum length of T_F is for DVB-T equal to $1/3 T_U$ for conventional channel estimation and for DVB-T2 equal to T_U / D_x , with D_x being dependent on the particular pilot pattern used.

Note: The T_F interval does not have to start from zero but could start from any negative or positive value, depending on the distribution of pre- and post-echoes.

The system can operate satisfactorily in a given location when the aggregate available $C/(N+I)$ is larger or equal to the required effective protection target EPT :

$$\frac{C}{N+I} \Big|_{\text{Available}} \equiv \frac{1}{(C/N)^{-1} + (C/I)^{-1}} \geq EPT \tag{A.4}$$

The required Effective Protection Target is given by (all the items are expressed in dB):

$$EPT = \begin{cases} C/N|_F + (C/N|_P - C/N|_F) \left(\frac{0.5}{(C/N|_P - C/N|_F)} \right)^{\frac{\kappa_A}{10}} & \text{for fixed reception} \\ C/N|_P & \text{for portable reception} \end{cases} \tag{A.5}$$

where:

EPT is the required system effective protection target in a particular SFN echo environment

$C/N|_F$ is the carrier to noise ratio required by the system on the F_1 channel (single transmitter, Rice channel).

$C/N|_P$ is the carrier to noise ratio required by the system on the P_1 channel (single transmitter, Rayleigh channel).

K_A “channel criticality due to artificial echoes” is the ratio (in dB) between the power received from the main transmitter and the total power of the artificial echoes inside the interval of correct equalisation T_F ; (if $K_A < 0$ dB, then K_A is forced to 0 dB)

2 List of DVB-T/T2 centre frequencies

Band	Channel id	Centre Frequency	Signal Bandwidth	Band	Channel id	Centre Frequency	Band	Channel id	Centre Frequency
VHF I	K2			(UHF) S III	S21	306	UHF IV	K21	474
	K3				S22	314		K22	482
	K4				S23	322		K23	490
(VHF) S I	S1	107.5	7		S24	330		K24	498
	D1	114.0	8		S25	338		K25	506
	S2	114.5	7 alt 8		S26	346		K26	514
	S3	121.5	7 alt 8		S27	354		K27	522
	D2	122.0	8		S28	362		K28	530
	S4	128.5	7 alt 8		S29	370		K29	538
	D3	130.0	8		S30	378		K30	546
	S5	135.5	7 alt 8		S31	386		K31	554
	D4	138.0	8		S32	394		K32	562
	S6	142.5	7 alt 8		S33	402		K33	570
	D5	146.0	8		S34	410		K34	578
	S7	149.5	7 alt 8		S35	418	K35	586	
	D6	154.0	8		S36	426	K36	594	
	S8	156.5	7 alt 8		S37	434	K37	602	
	D7	162.0	8		S38	442	K38	610	
	S9	163.5	7 alt 8		S39	450	K39	618	
	D8	170.0	8		S40	458	K40	626	
S10	170.5	7 alt 8	S41		466	K41	634		
VHF III	5 (K5)	177.5	7 alt 8			K42	642		
	D9	178.0	8			K43	650		
	K6	184.5	7 alt 8			K44	658		
	D10	186.0	8			K45	666		
	K7	191.5	7 alt 8			K46	674		
	D11	194.0	8			K47	682		
	K8	198.5	7 alt 8			K48	690		
	D12	202.0	8			K49	698		
	K9	205.5	7 alt 8			K50	706		
	D13	210.0	8			K51	714		
	K10	212.5	7 alt 8			K52	722		
	D14	218.0	8			K53	730		
(VHF) S II	K11	219.5	7 alt 8			K54	738		
	D15	226.0	8			K55	746		
	K12	226.5	7 alt 8			K56	754		
	S11	233.5	7 alt 8			K57	762		
	D16	234.0	8			K58	770		
	S12	240.5	7 alt 8			K59	778		
	D17	242.0	8			K60	786		
	S13	247.5	7 alt 8			K61	794		
	D18	250.0	8			K62	802		
	S14	254.5	7 alt 8			K63	810		
	D19	258.0	8			K64	818		
	S15	261.5	7 alt 8			K65	826		
	D20	266.0	8			K66	834		
	S16	268.5	7 alt 8			K67	842		
	D21	274.0	8			K68	850		
	S17	275.5	7 alt 8			K69	858		
D22	282.0	8							
S18	282.5	7 alt 8							
S19	289.5	7 alt 8							
D23	290.0	8							
S20	296.5	7 alt 8							
D24	298.0	8							

All Center Frequencies and Signal Bandwidth are listed in MHz. Names for channel_ids are proposed.

T2 block number	Centre frequency (MHz)	Frequency range* (MHz)
5A	174.928	174.0-181.0
5B	176.640	
5C	178.352	
5D	180.064	
6A	181.936	181.0-188.0
6B	183.648	
6C	185.360	
6D	187.072	
7A	188.928	188.0-195.0
7B	190.640	
7C	192.352	
7D	194.064	
8A	195.936	195.0-202.0
8B	197.648	
8C	199.360	
8D	201.072	
9A	202.928	202.0-209.0
9B	204.640	
9C	206.352	
9D	208.064	
10A	209.936	209.0-216.0
10B	211.648	
10C	213.360	
10D	215.072	
11A	216.928	216.0-223.0
11B	218.640	
11C	220.352	
11D	222.064	
12A	223.936	223.0-230.0
12B	225.648	
12C	227.360	
12D	229.072	
13A	230.784	230.0-240.0
13B	232.496	
13C	234.208	
13D	235.776	
13E	237.488	
13F	239.200	

Centre frequencies for 1.7 MHz frequency raster

3 Hierarchical mode reception

The NorDig IRD should be able to receive the hierarchical modes in the DVB-T specification: QPSK in 16QAM and QPSK in 64 QAM with the constellation proportion parameter $\alpha= 1,2$ and 4. The NorDig IRD shall be able to use both the Low Priority (LP) and High Priority bit stream (HP) to receive a MPEG transport stream.

The carrier-to-noise (C/N) ratio values in tables1 and 2 are specified for channel Profile 1.

Profile 1: Gaussian noise (N) is applied together with the wanted carrier (C) in a signal bandwidth.

No echo is applied.

Code rate	$\alpha = 1$		$\alpha = 2$	
	HP QPSK	LP 64QAM	HP QPSK	LP 64QAM
1/2	10.9	16.7	8.5	18.5
2/3	14.1	19.1	11	21.2
3/4	15.7	20.9	12.8	23.6

Table 1 Required C/N (dB) for a QEF reception for channel Profile 1 for hierarchical reception QPSK in 64QAM.

Code rate	$\alpha = 2$		$\alpha = 4$	
	HP QPSK	LP 16QAM	HP QPSK	LP 16QAM
1/2	6.8	15	5.8	19.5
2/3	9.1	17.2	7.9	21.4
3/4	10.4	18.4	9.1	22.5

Table 2 Required C/N (dB) for a QEF reception for channel Profile 1 for hierarchical reception QPSK in 16QAM.

Annex C: Bootloading and Service Lists in IP-based and other networks

Comment: The text in this Annex is being updated subject to changes in section 13.4

Annex D: Implementations Guidelines for best service selection in automatic channel search in terrestrial networks

Ref section “3.4.4.4 Installation mode: Automatic Search, best service”. A specified procedure is required in order to select, the best received service if a service is able to be received simultaneously from several transmitters. A service is defined equal if ON_id, TS_id and S_id are the same². Section 3.4.4.4 specifies that the selection shall be based on reception quality (i.e. received signal strength and signal quality) at the receiver input.

Regarding signal quality: The carrier to noise ratios (CNR) of the received signals provide information about the margins of the received signals (margin before the received signal begins to degrade). The estimate of these margins requires that the theoretically required CNR values must be known for the different DVB-T modes. Unfortunately, the received signal CNR doesn't provide enough information about the signal quality itself at low CNR values due the different required CNR in different reception path conditions e.g. in MFN and SFN. Therefore, in addition to received CNR, the received signal bit error rate (BER) (over a suitable integration time) must be taken into account in order to determine the received signal quality more precisely.

The signal quality alone doesn't provide enough information about the received signal margins. Therefore, in addition to signal quality, the signal strength must be taken in account in order to define the reception quality.

Defining reception quality for best service selection, as a function of signal strength and signal quality, is therefore essential for proper selection. Normally the selection is straightforward, but a difficulty may occur when selecting the best service between higher signal strength and worse signal quality and lower signal strength and better signal quality. A high difference between signal input strength can result to better margin before the received signal is degraded too much due to the variations in live reception and therefore could be better choice if the signal quality differences are little. If the signal quality difference is instead high, a choice of the lower signal strength may have a benefit at least when the signal input strengths are within a range of good margin and the difference is not too high.

An example of the flowchart in case of two received signals A and B is illustrated in figure 1. The IRD has to make a selection for a better service from two equal services. The following list describes the result of the selection algorithm in different conditions according to flowchart in figure 1.

1. signal quality and signal strength of A is better than B
2. signal quality of A is much better than B and signal strength of B is higher than A
3. signal quality of A is slightly better than B and signal strength of B is slightly higher than A
4. signal quality of A is slightly better than B and signal strength of B is much higher than A
5. signal quality and signal strength of B is better than A

² A service is uniquely identified by its DVB triplet (original_network_id, transport_stream_id and service_id) in all NorDig compliant terrestrial networks, except for the Norwegian terrestrial network, where only original_network_id and service_id are used to identify a service.

6. signal quality of B is much better than A and signal strength of A is higher than B
7. signal quality of B is slightly better than A and signal strength of A is slightly higher than B
8. signal quality of B is slightly better than A and signal strength of A is much higher than B

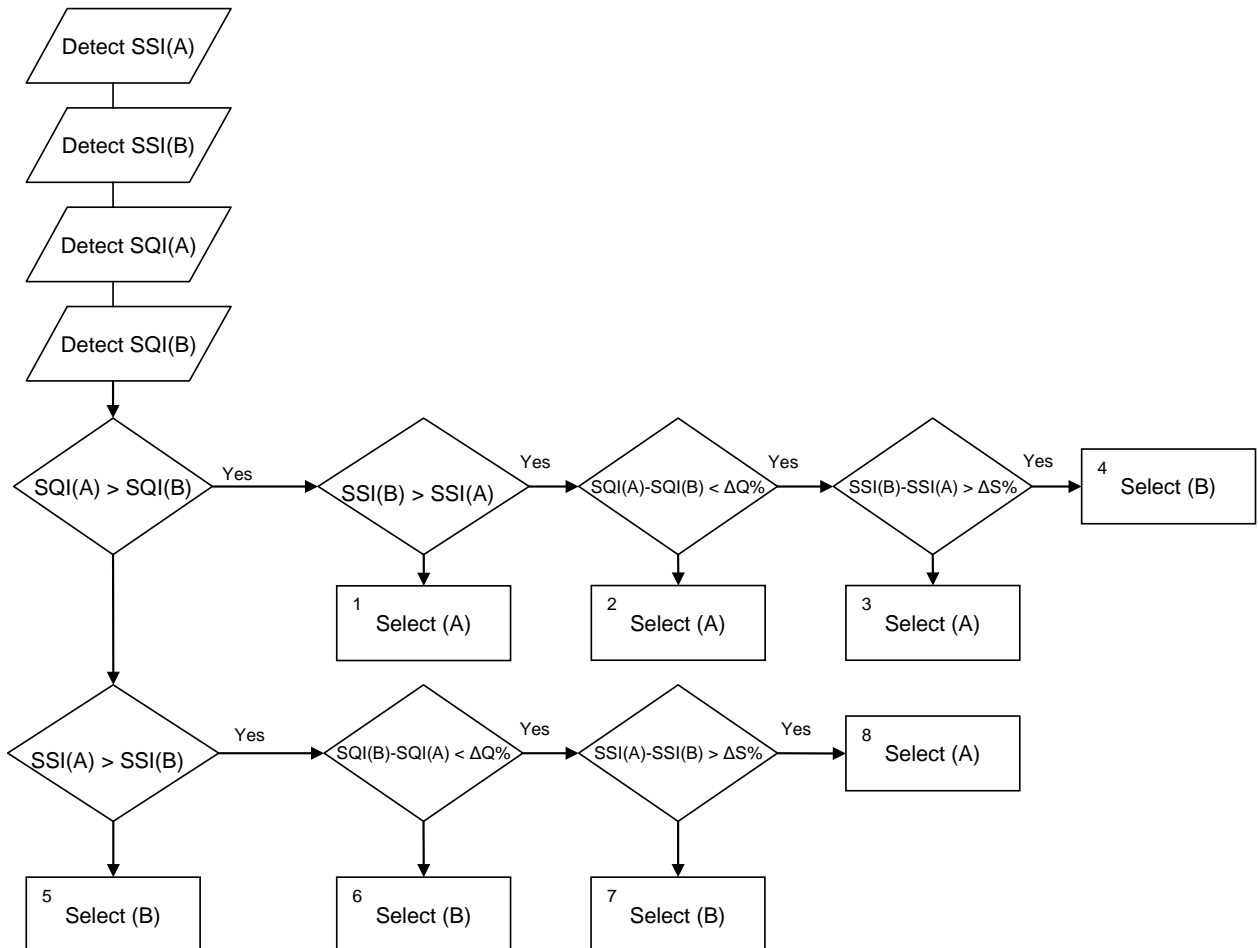

Figure 1 A flowchart for best service selection algorithm in case when two transmitters A and B transmit equal service and both of them are able to be received. ΔS and ΔQ refer to difference in SSI and SQI values and are defined as $\Delta S=10\%$ and $\Delta Q=20\%$.

Annex E: Raw carrier to noise values, $(C/N)_{RAW}$

Comment: The raw carrier to noise values, $(C/N)_{RAW}$, are used to calculate required C/N for BER 10^{-6} , after BCH decoding.

Modulation	Code rate	$(C/N)_{raw}$ (dB) Profile 1 Gaussian Channel	$(C/N)_{raw}$ (dB) Profile 2: 0 dB echo
QPSK	1/2	1.0	2.7
QPSK	3/5	2.2	4.3
QPSK	2/3	3.1	5.9
QPSK	3/4	4.1	7.3
QPSK	4/5	4.7	8.4
QPSK	5/6	5.2	9.5
16-QAM	1/2	6.2	8.4
16-QAM	3/5	7.6	10.2
16-QAM	2/3	8.9	11.8
16-QAM	3/4	10.0	13.7
16-QAM	4/5	10.8	15.2
16-QAM	5/6	11.3	16.3
64-QAM	1/2	10.5	13.4
64-QAM	3/5	12.3	15.4
64-QAM	2/3	13.6	17.0
64-QAM	3/4	15.1	19.2
64-QAM	4/5	16.1	21.0
64-QAM	5/6	16.7	22.3
256-QAM	1/2	14.4	17.9
256-QAM	3/5	16.7	20.2
256-QAM	2/3	18.1	22.0
256-QAM	3/4	20.0	24.3
256-QAM	4/5	21.3	26.3
256-QAM	5/6	22.0	27.8

Annex F: Recommendation for menu wordings and translations

Here follows guidelines/recommendation of wordings to be used in menus etc in the IRD for a number of functions with translation to NorDig's different native languages. This as a help to the IRD manufacture, to easier communicate and explain for the users/viewers the usage of a function, both from broadcasters and IRD manufacture point of view. The list of recommended wordings to functions is yet not complete and mainly includes functions that earlier experience has shown are most in need of advice (empty fields is intended to included in future releases).

In some cases, guidelines include Helping text in different languages that may be used to explain function in more detail, typically when user highlight/mark this function before selecting/changing this function's setting(s).

Subtitling

Normal Subtitles (subtitles)		
Language	Function wording	Helping text /description
English	'Subtitles' <i>or</i> 'Normal subtitles'	Normal subtitles that include translation of the spoken language into one or several languages for the viewer, in the case this subtitling is coming as a separate stream.
Swedish		
Norwegian	Teksting	Teksting på norsk av utenlandsk tale.
Danish	Tekstning	Tekstning på dansk af udenlandsk tale
Finnish	Tekstitys	Vieraskielisten ohjelmien tekstitys
Sami	Teaksta	Hállan tekstejuvvon sámegillii
Irish	Fotheidil nó Fotheideal teilitéacs	Fotheideal teilitéacs dúnta

Table - Annex F:1 Normal subtitles (see section 7 Subtitling) recommended wordings for IRD menus. (Normal subtitles includes typically textual translation of audio with foreign language for normal viewers. For Hard of hearing subtitling see below).

Accessibility

Audio description (audio)		
Language	Wording in language	Helping text /description in language
English	'Audio description' <i>or sometimes</i> 'Video description' <i>or sometimes</i> 'Narrative description'	A voice describes what is happening in the picture. It is intended for those who have visual impairments.
Swedish	'Ljudbeskrivning' <i>or</i> 'Syntolkning'	En röst beskriver händelser i bilden för de som har svårigheter att se.
Norwegian	'Synstolkning'	Talebeskrivelse av visuelle sanseintrykk for de som har problem med å se.
Danish	'Synstolkning'	Synstolkning er et særligt lydspor, som sendes samtidig med billedsiden til et tv-program som beskriver hvad der sker i billede
Finnish	'Kuvailutulkkaus'	Puhuttu kuvailuääni kertoo mitä ohjelmassa tapahtuu.

Sami	Gova tulkon	Njálmmálaččat muitaluvo čalmmeheamiide dat, mii govvas oidno.
Irish	Reacaireachta nó Físeán reacaireachta	

Table - Annex F:2 Accessibility - Audio - Audio description (see section 6.11 Supplementary audio) recommended wordings for IRD menus.

Spoken subtitles (audio)		
Language	Function wording	Helping text /description
English	‘Spoken subtitles’	A voice reads the subtitles for you. It is intended for those who have visual impairments.
Swedish	‘Talande textremsa’	En röst läser upp textremsan för de som har svårigheter att läsa textremsan.
Norwegian	‘Lydteksting’	En stemme som leser teksten for de som har synsproblemer.
Danish	‘Oplæste undertekster’	Oplæste undertekster, oplæster automatisk underteksterne på fremmed-sprogede programmer
Finnish	‘Puhetekstitys’	Käännöstekstitys kuuluu puheena yhdessä ohjelmaaänen kanssa.
Sami	Teaksta lohkojuvvo	Teksten lohkojuvvo čalmmeheamiide.
Irish	Fotheideal labhartha	

Table - Annex F:3 Accessibility - Audio – Spoken subtitles (see section 6.11 Supplementary audio) recommended wordings for IRD menus. This is in the case the IRD has settings to differentiate normal audio description from spoken subtitling. If the IRD has one and the same setting for both normal audio description and spoken subtitling then recommend using the wordings for Audio description above.

Supplementary Audio Mixing Level (relative volume control of audio receiver mixing)		
Language	Function wording	Helping text /description
English	‘Supplementary Audio Mixing Level’ or ‘Audio mixing’	Select the balance between supplementary audio and normal audio.
Swedish	‘Ljudmixning’	Bestäm balansen mellan kompletterande ljud och vanligt ljud
Norwegian	‘Lydnivå på lydteksting og synstolking’	Bestemme ballanse mellom lydteksting eller synstolking og originallyd
Danish		
Finnish	‘Lisä-äänen voimakkuus’	Pää- ja lisä-äänen välisen voimakkuuden säätö.
Sami	Jietnatekstema ja govvadulkoma jietnadássi	Jietnatekstema dahje govvadulkoma ja originálajienaid dássádallan
Irish	Meascadh fuaimne nó Meascadh leibhéal	

Table - Annex F:4 Accessibility - Audio - relative volume control of audio receiver mixing (see section 6.11.3.5 in Supplementary audio) recommended wordings for IRD menus.

Sign language (video)		
Language	Function wording	Helping text /description
English	'Sign language'	For those who have hearing impairments
Swedish	'Teckenspråkstolkning'	För de som har svårigheter att höra.
Norwegian	'Tegnspråk'	Tegnspråktolkning for de som har hørselsproblemer
Danish	'Tegnsprogstolkning'	Tegnsprog er et tilbud til døve, der ellers ikke kan følge med i udsendelser
Finnish	'Viittomakieli'	
Sami	Seavagiella	Seavagillii dulkojuvvo bealjehemiide.
Irish	Teanga chomharthaíochta	

Table - Annex F:5 Accessibility, Video, Sign Language recommended wordings for IRD menus.

Subtitles for Hard Of Hearing (subtitles)		
Language	Function wording	Helping text /description
English	'Subtitles for Hard Of Hearing'	
Swedish	'Textremsa för hörselnedsatta' <i>or</i> 'Undertext för hörselnedsatta'	
Norwegian	'Teksting for hørselshemmede'	Teksting av norsk tale
Danish	'Tekstet'	Undertekster af dansk tale
Finnish	'Tekstitys huonokuuloisille'	
Sami	Teksten bealjehemiide	Njálmmálaš dárogiella tekstejuvvo
Irish	Fotheidil	

Table - Annex F:6 Subtitling – Hard of hearing subtitles (see section 7 Subtitling) recommended wordings for IRD menus.

SI – recommendation wordings

Country name in native			
Country (in English)	ISO 3166 country code	Language	Wording in language (translation to be used)
SWEDEN	SWE	Swedish	'Sverige'
DENMARK	DNK	Danish	'Danmark'
IRELAND	IRL	Irish	'Éire'
FINLAND	FIN	Finnish	'Suomi'
NORWAY	NOR	Norwegian	'Norge'

Table - Annex F:7 SI - country name (see section 12.1.8) recommended wordings for IRD menus.

Language name in native			
Language (in English)	ISO 639-2 language code	Language	Wording in language (translation to be used)
Danish	dan	Danish	'Dansk'
English	eng	English	'English'
Finnish	fin	Finnish	'Suomi'
Irish / Gaelic	iri	Irish / Gaelic	'Gaeilge'
Irish / Gaelic	gle	Irish / Gaelic	'Gaeilge'
Norwegian	nor	Norwegian	'Norsk'

Narrative	nar	English	'Narrative'
Original language	qaa	Danish	'Original'
Original language	qaa	English	'Original'
Original language	qaa	Finnish	'Alkuperäinen'
Original language	qaa	Irish / Gaelic	'Bunaidh'
Original language	qaa	Norwegian	'Original'
Original language	qaa	Swedish	'Original'
Sami	smi	Sami	'Sámegiella'
Swedish	swe	Svenska	'Svenska'
Undefined	und	Danish	'Udefineret'
Undefined	und	English	'Undefined'
Undefined	und	Finnish	'Määrittelemätön'
Undefined	und	Irish / Gaelic	'Neamhshainithe'
Undefined	und	Norwegian	'Undefined'
Undefined	und	Swedish	'Odefinierat'

Table - Annex F:8 SI - Language name (see section 12.1.8) recommended wordings for IRD menus.

SI EIT/Navigator, time slots with no event information		
Language	Function wording	Helping text /description
English	'No event information'	
Swedish	'Ingen information'	
Norwegian	'Ingen programinformasjon'	
Danish	'Ingen programinformation'	
Finnish	'Ei ohjelmatietoja'	
Irish		

Table - Annex F:9 SI/Navigator – SI – EIT – in ESG/EPG for time slots with no event information available (see section 13.3.2.3).

:

Annex G: Guidelines for NorDig IRD audio selection

Example table when more than one audio stream is received

This table is given by the property rules of table 6.1. The table covers many possible cases, although not every possible one.

Supported available input stream types and audio formats as signaled by note 1 in table 16.2 (examples)	Output on S/PDIF and HDMI (incl. HDMI Audio Return Channel) (Note 4)		Output on 2 ch analogue output(s) and/or built in loudspeaker(s) (see note 5)	
	When Stereo mode is selected (default)	When Multichannel mode is selected	When Stereo mode is selected (default)	When Multichannel mode is selected
MPEG-1 layer II & AC-3 multichannel	PCM (from MPEG-1 layer II)	AC-3 (from AC-3 multichannel) (see note 1)	Decoded MPEG-1 Layer II	Decoded downmixed AC-3
MPEG-1 layer II & E-AC-3 multichannel	PCM (from MPEG-1 layer II)	E-AC-3 on HDMI (from E-AC-3 multichannel) (see note 2) E-AC-3 transcoded to AC-3 on S/PDIF (from E-AC-3 multichannel) (see note 1)	Decoded MPEG-1 Layer II	Decoded downmixed E-AC-3
MPEG-1 layer II & HE-AAC multichannel	PCM (from MPEG-1 layer II)	HE-AAC multichannel on HDMI (from HE-AAC multichannel) (see note 3) HE-AAC transcoded to AC-3 or DTS on S/PDIF (from HE-AAC multichannel)	Decoded MPEG-1 Layer II	Decoded downmixed HE-AAC
HE-AAC stereo & AC-3 multichannel	PCM (from HE-AAC stereo)	AC-3 (from AC-3 multichannel) (see note 1)	Decoded HE-AAC	Decoded downmixed AC-3
HE-AAC stereo & E-AC-3 multichannel	PCM (from HE-AAC stereo)	E-AC-3 on HDMI (from E-AC-3 multichannel) (see note 2) E-AC-3 transcoded to AC-3 on S/PDIF (from E-AC-3 multichannel) (see note 1)	Decoded HE-AAC	Decoded downmixed E-AC-3
HE-AAC stereo & HE-AAC multichannel	PCM (from HE-AAC stereo)	HE-AAC multichannel on HDMI (from HE-AAC multichannel) (see note 1 + 3) HE-AAC transcoded to AC-3 or DTS on S/PDIF (from HE-AAC multichannel)	Decoded HE-AAC stereo	Decoded downmixed HE-AAC multichannel

AC-3 stereo & AC-3 multichannel	PCM (from AC-3 stereo)	AC-3 (from AC-3 multichannel) (see note 1)	Decoded AC-3 stereo	Decoded downmixed AC-3 multichannel
HE-AAC multichannel & AC-3 multichannel	PCM (from downmixed HE-AAC)	HE-AAC multichannel on HDMI (from HE-AAC multichannel) (see note 1 + 3) HE-AAC transcoded to AC-3 or DTS on S/PDIF (from HE-AAC multichannel)	Decoded downmixed HE-AAC	Decoded downmixed HE-AAC
MPEG-1 layer II & AC-3 stereo	PCM (from MPEG-1 layer II)	AC-3 (from AC-3 stereo) (see note 1)	Decoded MPEG-1 Layer II	Decoded AC-3
MPEG-1 layer II & HE-AAC stereo	PCM (from MPEG-1 layer II)	HE-AAC on HDMI (from HE-AAC) (see note 3) HE-AAC transcoded to AC-3 or DTS on S/PDIF (from HE-AAC multichannel)	Decoded MPEG-1 Layer II	Decoded HE-AAC
HE-AAC stereo & AC-3 stereo	PCM (from HE-AAC stereo)	HE-AAC on HDMI (from HE-AAC) (see note 3) HE-AAC transcoded to AC-3 or DTS on S/PDIF (from HE-AAC)	Decoded HE-AAC	Decoded HE-AAC

Example table. Examples of possible simulcast situations and signals on analog and digital outputs dependent on user settings with equal languages and normal audio types. For IDTVs, this shall apply when External Audio System (if supported) is selected as audio output.

Note 1: The S/PDIF output shall in any case comply with the content of the table above. For HDMI however, the following feature should be implemented:

When an HDMI Sink device indicates in its E-EDID structure that it only supports Basic Audio (i.e. two-channel L-PCM from the original stereo signal or from a stereo down-mix from the multi-channel signal), then the HDMI output will provide Basic Audio. This feature would then take precedence over the requirement of AC-3, E-AC-3, HE-AAC multi-channel and DTS in the table above whenever the Sink device indicates that only Basic Audio is supported. Observe however that the HDMI output could be different from S/PDIF output, since S/PDIF still has to comply with multi-channel format requirements as in the table above.

Note 2: If an HDMI sink device indicates in its E-EDID structure that AC-3 decoding is supported, but E-AC-3 decoding is not supported, the IRD shall transcode E-AC-3 streams to AC-3 prior to HDMI transmission.

Note 3: If an HDMI sink device indicates in its E-EDID structure that AC-3 or DTS is supported, but HE-AAC decoding is not supported, the IRD shall transcode HE-AAC streams to AC-3 or DTS prior to HDMI transmission.

Note 4: For IDTVs, this shall apply when optional External Audio System is selected as audio output. If built-in loudspeakers are selected for audio output, the minimum requirement is to have PCM output signal in the digital output.

Note 5: When External Audio System is selected as main audio output, IDTVs may optionally mute the TV speakers.

Annex H: Loudness levels, – Typical IDTV Audio Block diagram

The following diagram represents a typical IDTV IRD audio implementation. The implementation though will vary from manufacturer to manufacturer and chassis to chassis depending on feature level and cost. For technical reasons such as processing power, memory and general architecture, it is common for the functionality offered by some of the operational blocks shown to be mutually exclusive. e.g. only one decode process at a time may be supported.

The output levels shown are those suggested by recent publications by EBU (R128 [74] and Tech 3344 [75]). It is expected that the industry will move towards following the levels shown here, though it must be expected that changes to architectures required to support these levels depend on IC and chassis design lead times so must be still considered as guidance only.

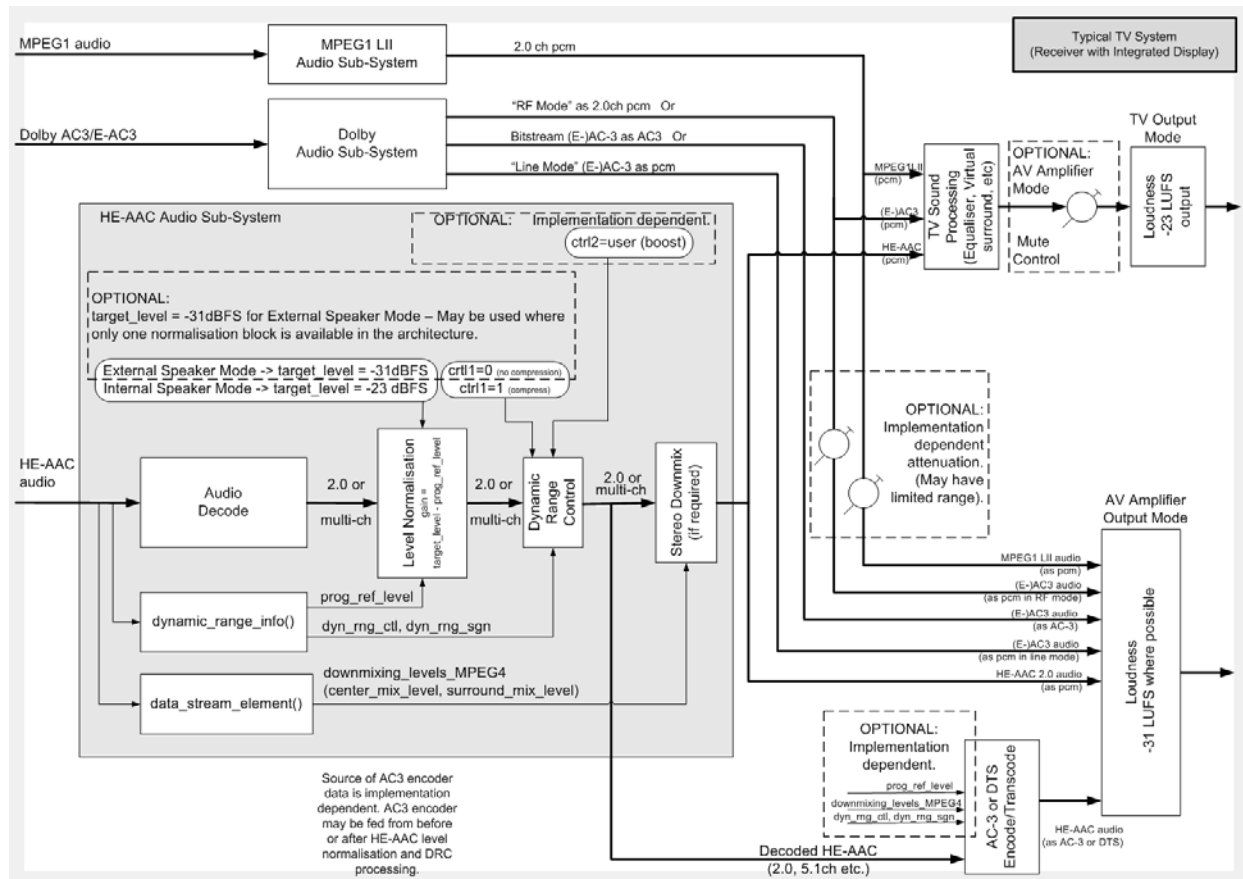

Note : Informative. Diagram is based on diagram in UK D-Book 7A [67], and shared by kind permission of the DTG. This shall be interpreted as informative only.

The outputs shown are labeled ‘TV Output Mode’ and ‘AV Amplifier Output Mode’; these terms are intended to denote output to TV speakers and external AV Amplifier/System respectively.

Due to system architecture limitations, it is common for PCM outputs to external AV systems to follow the same levels as outputs to internal TV speakers. Architectures often mute the TV speakers in order to process audio in formats specifically suitable for external AV systems (e.g. -31 LUFS dialogue level with increased dynamic range).

The general concept of loudness levels at different outputs are:

– Programme reference level at analogue outputs should be -23 dBFS (as measured on a digital signal).

– Programme reference level at digital outputs (S/PDIF and HDMI) should be -31 dBFS.

In this way, users with lower quality of speaker systems will experience a dynamic range which is appropriate for these systems. Users with (usually external) higher quality systems will be able to experience larger (original) dynamic range.

As guidance, these standards and documents are to be considered:

- EBU Recommendation R 128, Loudness normalisation and permitted maximum level of audio levels [74]
- EBU Technical Recommendation R 68-2000, Alignment level in digital audio production equipment and in digital audio recorders [76].
- EBU Tech 3341, Loudness Metering: “EBU mode” metering to supplement loudness normalisation in accordance with EBU R 128 [74]
- EBU Tech 3344 , Loudness normalisation in distribution
- ITU Recommendation ITU-R BS.1770-2 (march 2011), Algorithms to measure audio programme loudness and true-peak audio level [78]
- ITU Recommendation ITU-R BS.1771, Requirements for loudness and true-peak indicating meters [79]

Annex I: Examples of Signalling to be used for audio property

Example table of priority between audio signalling alternatives related to audio property.

This table is given by the property rules of section 6.5.1 and shows which signalling (descriptor or stream type) shall be used for each audio property of the audio stream during the selection of audio stream. The table covers a number of relevant cases, although not every possible one is listed. For services with multiple audio streams, the NorDig IRD has to parse the signalling inside the PMT for the audio streams to select the appropriate audio stream(s) to decode in accordance with the IRD user preference settings. After the selection of audio stream and during the actual audio decoding, the IRD shall primarily rely on signaling inside the PES stream for the audio format. (Example for an audio that dynamically changes between stereo and multichannel, the audio format in the PMT is signaled as multichannel while the signaling inside the PES stream signalize stereo).

codec				Signalling in incoming stream					IRD, Signalling to be used during the selection of audio stream for each audio property.			
MPEG-1 L.II	HE-AAC	AC-3	E-AC-3	PMT stream type	Supplementary audio descriptor (SAD)		[1] AAC/ AC-3/ E-AC-3 descriptor	[2] ISO639 descriptor (lang, type)	Lang	Type	Format	stream type
					mix type, edit class	ISO639 lang						
X	X			X						("normal")	(stereo)	stream type
X	X			X				X	[2]	[2]	(stereo)	stream type
	X	X	X	X			X			[1]	[1]	[1]
	X	X	X	X			X	X	[2]	[1]	[1]	[1]
	X	X	X	X	X		X	X	[2]	SAD	[1]	[1]
X	X			X	X			X	[2]	SAD	(stereo)	stream type
	X	X	X	X	X	X	X	X	SAD	SAD	[1]	[1]
	X	X	X	X	X	X	X		SAD	SAD	[1]	[1]

X (codec): applicable case for these audio codecs,

X (signalling); signaling/descriptor included in incoming MPEG-2 TS for the audio stream

SAD: Supplementary Audio Descriptor

("normal"): Audio Type is not included in signalling, IRD shall then assume that the audio stream is of a "normal" type.

(Stereo): Audio Format is not included in signalling, IRD shall then assume that the audio stream has stereo format.

Example table. Examples of signalling alternatives for the audio property and priority the IRD shall have between the incoming signalling.

Chapter/Section		ND-Basic		ND-Hybrid		ND-Basic PVR		Comment
		STB	IDTV	STB	IDTV	STB	IDTV	
2.2.15	Additional hardware/firmware for the PVR features	---	---	---	---	---	---	
2.3	System Software and API	---	---	---	---	---	---	
2.3.1	Introduction	---	---	---	---	---	---	
2.3.2	Principal Software Architecture	---	---	---	---	---	---	
2.3.3	System Software	---	---	---	---	---	---	
2.3.4	NorDig APIs	---	---	---	---	---	---	
2.3.5	PVR related software	---	---	---	---	---	---	
2.4	General Product Requirement	---	---	---	---	---	---	
2.4.1	General	M	M	M	M	M	M	
2.4.2	Energy Efficiency	M	M	M	M	M	M	
2.4.3	Requirements that are optional for a time period (grace period)	M	M	M	M	M	M	
PART A: Hardware and Firmware								
3	The Frontend of the NorDig IRD	---	---	---	---	---	---	
3.1	Common Features	---	---	---	---	---	---	
3.1.1	General Features	M	M	M	M	M	M	
3.1.2	Common Scanning Procedures	M	M	M	M	M	M	
3.1.3	Quality Reception Detector	M	M	M	M	M	M	
3.2	Satellite Tuner and Demodulator	---	---	---	---	---	---	
3.2.1	General	M	M	M	M	M	M	
3.2.2	RF/IF Characteristics	M	M	M	M	M	M	
3.2.3	Input Frequency Range/Tuning Range	M	M	M	M	M	M	
3.2.4	Demodulation and Error Correction	M	M	M	M	M	M	
3.2.5	Control Signals	M	M	M	M	M	M	
3.2.6	Tuning/ Scanning Procedures	M	M	M	M	M	M	
3.2.7	Satellite Tuner Interface and Signal Levels	M	M	M	M	M	M	
3.2.8	Performance	M	M	M	M	M	M	
3.3	Cable Tuner and Demodulator	---	---	---	---	---	---	
3.3.1	General	M	M	M	M	M	M	
3.3.2	RF Characteristics	M	M	M	M	M	M	
3.3.3	Bypass RFin to RF out	M	M	M	M	M	M	
3.3.4	Tuning/Scanning Procedure	M	M	M	M	M	M	
3.3.5	Performance Data	M	M	M	M	M	M	
3.3.6	Spurious Emission	M	M	M	M	M	M	
3.4	Terrestrial Tuner and Demodulator	---	---	---	---	---	---	
3.4.1	General	M	M	M	M	M	M	
3.4.2	Frequencies and Signal Bandwidths	M	M	M	M	M	M	
3.4.3	Modes	M	M	M	M	M	M	
3.4.4	Reception quality/Tuning/Scanning Procedures	M	M	M	M	M	M	
3.4.5	Changes In Modulation Parameters	M	M	M	M	M	M	
3.4.6	RF Input Connector	M	M	M	M	M	M	
3.4.7	RF Output Connector (option)	O	O	O	O	O	O	
3.4.8	Time Interleaving	M	M	M	M	M	M	
3.4.9	Input/Output Data Formats	M	M	M	M	M	M	
3.4.10	Performance	M	M	M	M	M	M	
3.5	IP Based Front-End	---	---	---	---	---	---	
3.5.1	General	M	M	M	M	M	M	
3.5.2	Network Interface	M	M	M	M	M	M	
3.5.3	Protocol Suite	M	M	M	M	M	M	
3.5.4	Dynamic Address Allocation	M	M	M	M	M	M	
3.5.5	Service Selection	M	M	M	M	M	M	
4	MPEG-2 Demultiplexer	---	---	---	---	---	---	
4.1	General	M	M	M	M	M	M	
4.2	DVB Descrambler Performance	M	M	M	M	M	M	
4.3	System Clock Recovery	M	M	M	M	M	M	
5	Video	---	---	---	---	---	---	
5.1	General requirements	M	M	M	M	M	M	
5.1.1	Reference Model for Video Decoder	M	M	M	M	M	M	
5.2	Supported resolutions and frame rates	M	M	M	M	M	M	
5.3	Up-sampling/Up-converting	M	M	M	M	M	M	
5.4	Colorimetry	M	M	M	M	M	M	
5.5	Dynamic changes in the video stream	M	M	M	M	M	M	
5.6	AVC still picture	M	M	M	M	M	M	
5.7	Minimum video bandwidth	M	M	M	M	M	M	

Chapter/Section		ND-Basic		ND-Hybrid		ND-Basic PVR		Comment
		STB	IDTV	STB	IDTV	STB	IDTV	
5.8	Frame Cropping	M	M	M	M	M	M	
5.9	Overscan	M	M	M	M	M	M	
5.9.1	Safe area for overscan	M	M	M	M	M	M	
5.10	High Definition Video Output and Display	M	M	M	M	M	M	
5.11	Down-conversion of High Definition Video for Standard Definition output	M	M	M	M	M	M	
5.12	Display Format for other Aspect Ratios	M	M	M	M	M	M	
5.13	Rescaling for HbbTV application	M	M	M	M	M	M	
6	AUDIO	---	---	---	---	---	---	
6.1	General	M	M	M	M	M	M	
6.1.1	Audio User Preference Settings	M	M	M	M	M	M	
6.1.2	Audio terminology	M	M	M	M	M	M	
6.2	Audio Decoding	M	M	M	M	M	M	
6.2.1	MPEG-1 Layer II: Requirements on Audio Handling	M	M	M	M	M	M	
6.2.2	E-AC-3 and AC-3: Requirements on Audio Handling	M	M	M	M	M	M	
6.2.3	HE-AAC: Requirements on Audio Handling	M	M	M	M	M	M	
6.3	Multichannel Audio	M	M	M	M	M	M	
6.4	Stereo Audio	M	M	M	M	M	M	
6.5	Audio Prioritising	M	M	M	M	M	M	
6.5.1	Audio Prioritising, Type ("Normal" or supplementary)	M	M	M	M	M	M	
6.5.2	Audio Prioritising, Languages	M	M	M	M	M	M	
6.5.3	Audio Prioritising, Format (multichannel or stereo)	M	M	M	M	M	M	
6.5.4	Signalling to be used for audio property	M	M	M	M	M	M	
6.5.5	Examples of priority	M	M	M	M	M	M	
6.6	Audio Output Formats	M	M	M	M	M	M	
6.7	Audio Video Synchronisation	M	M	M	M	M	M	
6.7.1	Adjustment of Audio/Video delay	M	M	M	M	M	M	
6.8	Audio Output Signals	M	M	M	M	M	M	
6.8.1	Analogue Audio Output (SCART, RCA)	M	M	M	M	M	M	
6.8.2	Digital Audio Output (HDMI, HDMI ARC and S/PDIF)	M	M	M	M	M	M	
6.9	Dynamic Changes	M	M	M	M	M	M	
6.10	Clean Audio	M	M	M	M	M	M	
6.11	Supplementary Audio	M	M	M	M	M	M	
6.11.1	Informative for Supplementary Audio	M	M	M	M	M	M	
6.11.2	General requirements for supplementary audio	M	M	M	M	M	M	
6.11.3	IRD settings for Supplementary Audio	M	M	M	M	M	M	
6.11.4	Selection of audio streams	M	M	M	M	M	M	
6.11.5	Signalling for Supplementary Audio	M	M	M	M	M	M	
6.11.6	Receiver mixing	M	M	M	M	M	M	
6.11.7	Receiver mixed on its own on for head-phones output	M	M	M	M	M	M	
6.11.8	Broadcast mixed	M	M	M	M	M	M	
6.12	IRD Internal Reference Level	M	M	M	M	M	M	
6.13	Loudness Levels, - Dynamic Range Control and Downmixing	M	M	M	M	M	M	
6.13.1	HE-AAC Audio Input and AC-3/E-AC-3 Audio Input	M	M	M	M	M	M	
6.13.2	MPEG-1 Layer II Audio Input	M	M	M	M	M	M	
6.13.3	Audio Output Levels	M	M	M	M	M	M	
7	TELETEXT AND SUBTITLING	---	---	---	---	---	---	
7.1	General	---	---	---	---	---	---	
7.1.1	Subtitling user preferences	---	---	---	---	---	---	
7.1.2	Only display subtitling if match language in user preferences	M	M	M	M	M	M	
7.1.3	Temporary changes to subtitling settings	M	M	M	M	M	M	

Chapter/Section		ND-Basic		ND-Hybrid		ND-Basic PVR		Comment
		STB	IDTV	STB	IDTV	STB	IDTV	
7.1.4	Subtitling mode (Normal and Hard of hearing subtitling)	---	---	---	---	---	---	
7.1.5	Simultaneous EBU and DVB subtitling	M	M	M	M	M	M	
7.1.6	Simultaneous EBU Teletext and HbbTV Digital Teletext	M	M	M	M	M	M	
7.1.7	Simultaneous Subtitling and HbbTV	M	M	M	M	M	M	
7.2	EBU Teletext	M	M	M	M	M	M	
7.2.1	General	M	M	M	M	M	M	
7.2.2	Additional requirements for Analogue video Interface	M	M	M	M	M	M	
7.3	DVB Subtitling	M	M	M	M	M	M	
7.3.1	General	M	M	M	M	M	M	
7.3.2	Subtitling subset	M	M	M	M	M	M	
8	Interfaces and Signal Levels	---	---	---	---	---	---	
8.1	Introduction	---	---	---	---	---	---	
8.2	RF- bypass (option)	O	O	O	O	O	O	
8.3	Two-way Interface	O	O	O	O	O	O	
8.4	SCART Interfaces (Option)	O	O	O	O	O	O	
8.5	Audio Output Interfaces (Option)	M	M	M	M	M	M	
8.5.1	VCR SCART connector for analogue audio	M	---	M	---	M	---	
8.5.2	RCA connector for analogue audio	O	O	O	O	O	O	
8.5.3	S/PDIF connector for digital audio	O	O	O	O	O	O	
8.5.4	Headphone connector for analogue audio	O	O	O	O	O	O	
8.6	HDMI Interface	M	M	M	M	M	M	
8.6.1	General	M	M	M	M	M	M	
8.6.2	Video Output and Display	M	M	M	M	M	M	
8.6.3	Audio Output	M	M	M	M	M	M	
8.6.4	Signal protection	M	M	M	M	M	M	
8.6.5	Additional analogue interfaces for NorDig IRD signals (option)	M	M	M	M	M	M	
8.7	Remote Control Interface	M	M	M	M	M	M	
8.7.1	General	M	M	M	M	M	M	
8.7.2	Functions	M	M	M	M	M	M	
9	Interfaces for Conditional Access	---	---	---	---	---	---	
9.1	General	M	M	M	M	M	M	
9.2	Use of the Common Interface	M	M	M	M	M	M	
9.2.1	General	---	---	---	---	---	---	
9.2.2	Minimum requirements for the Common Interface	M	M	M	M	M	M	
9.2.3	Minimum requirements for the NorDig CA-Module	M	M	M	M	M	M	
9.3	Use of Smart Card Reader	---	---	---	---	---	---	
9.3.1	General	M	M	M	M	M	M	
9.3.2	The Smart Card Interface	M	M	M	M	M	M	
9.3.3	ECM and EMM Filtering	M	-	M	-	M	-	
9.3.4	Descrambling of selected services	M	M	M	M	M	M	
9.3.5	Application Level Interface for Conditional Access.	---	---	M	M	M	M	
10	THE SYSTEM SOFTWARE UPDATE	---	---	---	---	---	---	
10.1	General	M	M	M	M	M	M	
10.1.1	User control of SSU	M	M	M	M	M	M	
10.1.2	SSU procedure	M	M	M	M	M	M	
10.1.3	User notification for SSU	M	M	M	M	M	M	
10.1.4	Security requirements for SSU	M	M	M	M	M	M	
10.1.5	Previous user settings and installation after SSU	---	---	---	---	---	---	
10.1.6	Rejection and Reminder for SSU	M	M	M	M	M	M	
10.2	Download via broadcast channels	M	M	M	M	M	M	
10.2.1	SSU alternatives and functionality	M	M	M	M	M	M	
10.2.2	IRDs with access to multiple SSU services	M	M	M	M	M	M	
10.3	Download via local interface or IP-based interface	M	M	M	M	M	M	

Chapter/Section		ND-Basic		ND-Hybrid		ND-Basic PVR		Comment
		STB	IDTV	STB	IDTV	STB	IDTV	
10.4	Network Management and Provisioning	M	M	M	M	M	M	
10.5	The System Download Mechanism via broadcast channels	M	M	M	M	M	M	
10.5.1	SSU Signaling	M	M	M	M	M	M	
10.5.2	Update Notification Table (UNT)	M	M	M	M	M	M	
10.5.3	Data carriage	M	M	M	M	M	M	
10.6	CIP-CAM software updates	M	M	M	M	M	M	
11	Performance	---	---	---	---	---	---	
11.1	Introduction	---	---	---	---	---	---	
11.2	Video Performance of RGB and PAL Signals	M	M	M	M	M	M	
11.3	Audio Performance of the Decoded Digital Signal	M	M	M	M	M	M	
11.4	Zapping Time for TV Services	M	M	M	M	M	M	
Part B: The system software with application								
12	Service Information	---	---	---	---	---	---	
12.1	General	---	---	---	---	---	---	
12.1.1	General Requirements	M	M	M	M	M	M	
12.1.2	PSI/SI classification	M	M	M	M	M	M	
12.1.3	Private data specifier value	M	M	M	M	M	M	
12.1.4	Service Types	M	M	M	M	M	M	
12.1.5	Service Categories	M	M	M	M	M	M	
12.1.6	Used PSI/SI descriptors	M	M	M	M	M	M	
12.1.7	Character sets in text strings	M	M	M	M	M	M	
12.1.8	Country and Language Codes within PSI/SI	M	M	M	M	M	M	
12.2	Network Information Table (NIT)	M	M	M	M	M	M	
12.2.1	The Network information Table Descriptors	M	M	M	M	M	M	
12.2.2	Metadata Pointer Descriptor (NorDig PVR only, Broadcast Record Lists)	M-PVR	M-PVR	M-PVR	M-PVR	M-PVR	M-PVR	
12.2.3	Cable Delivery System Descriptor	M	M	M	M	M	M	
12.2.4	Terrestrial Delivery System Descriptor	M	M	M	M	M	M	
12.2.5	T2 Delivery System Descriptor	M	M	M	M	M	M	
12.2.6	Linkage Descriptor	M	M	M	M	M	M	
12.2.7	Frequency List Descriptor	M	M	M	M	M	M	
12.2.8	Default authority descriptor (in NIT) (NorDig PVR only)	M-PVR	M-PVR	M-PVR	M-PVR	M-PVR	M-PVR	
12.2.9	NorDig private; Logic_Channel_descriptor (LCD)	M	M	M	M	M	M	
12.3	Service Description Table (SDT)	M	M	M	M	M	M	
12.3.1	The Service Descriptor Table Descriptors	M	M	M	M	M	M	
12.3.2	Service Descriptor	M	M	M	M	M	M	
12.3.3	CA Identifier Descriptor	M	M	M	M	M	M	
12.3.4	Linkage Descriptor	M	M	M	M	M	M	
12.3.5	Default authority descriptor (in SDT) (NorDig PVR only)	M	M	M	M	M	M	
12.4	Event Information Table	M	M	M	M	M	M	
12.4.1	General	M	M	M	M	M	M	
12.4.2	The Event Information Table Descriptors	M	M	M	M	M	M	
12.4.3	CA Identifier Descriptor	M	M	M	M	M	M	
12.4.4	Content Descriptor	M	M	M	M	M	M	
12.4.5	Content Identifier Descriptor (NorDig PVR only)	M	M	M	M	M	M	
12.4.6	CRID encoding and reuse (NorDig PVR only)	M	M	M	M	M	M	
12.4.7	Event Information Table Schedule	M	M	M	M	M	M	
12.5	Time and Date Table and Time Offset Table	M	M	M	M	M	M	
12.5.1	Time Offset Table Descriptor	M	M	M	M	M	M	
12.6	Conditional Access and Program Map Tables	M	M	M	M	M	M	
12.6.1	Conditional Access Table Descriptors	M	M	M	M	M	M	
12.6.2	Program Map Table Descriptors	M	M	M	M	M	M	

Chapter/Section		ND-Basic		ND-Hybrid		ND-Basic PVR		Comment
		STB	IDTV	STB	IDTV	STB	IDTV	
13.5	User Information (UI) about service components (audio and subtitling)	M	M	M	M	M	M	
13.5.1	UI for Audio information	M	M	M	M	M	M	
13.5.2	UI for Subtitling information	M	M	M	M	M	M	
13.6	Accessibility menus and settings	M	M	M	M	M	M	
13.6.1	Accessibility settings	M	M	M	M	M	M	
13.6.2	Talking menus (optional)	O	O	O	O	O	O	
14	NorDig PVR feature requirements (NorDig PVR only)	---	---	---	---	---	---	
14.1	Introduction- PVR	M-PVR	M-PVR	M-PVR	M-PVR	M-PVR	M-PVR	
14.2	General- PVR	M-PVR	M-PVR	M-PVR	M-PVR	M-PVR	M-PVR	
14.2.1	Recording File System	M-PVR	M-PVR	M-PVR	M-PVR	M-PVR	M-PVR	
14.2.2	Recording capacity	M-PVR	M-PVR	M-PVR	M-PVR	M-PVR	M-PVR	
14.2.3	Deletion of recordings	M-PVR	M-PVR	M-PVR	M-PVR	M-PVR	M-PVR	
14.2.4	Failed and incomplete recordings	M-PVR	M-PVR	M-PVR	M-PVR	M-PVR	M-PVR	
14.2.5	Save only the last number of episodes	M-PVR	M-PVR	M-PVR	M-PVR	M-PVR	M-PVR	
14.2.6	File system intact after update	M-PVR	M-PVR	M-PVR	M-PVR	M-PVR	M-PVR	
14.2.7	Limitations in local storage, interfaces, extraction and removable media for recordings	M-PVR	M-PVR	M-PVR	M-PVR	M-PVR	M-PVR	
14.2.8	Disk management / de-fragmentation	M-PVR	M-PVR	M-PVR	M-PVR	M-PVR	M-PVR	
14.2.9	Safe margins	M-PVR	M-PVR	M-PVR	M-PVR	M-PVR	M-PVR	
14.2.10	NorDig Record Lists functionality	M-PVR	M-PVR	M-PVR	M-PVR	M-PVR	M-PVR	
14.3	PVR Recording	M-PVR	M-PVR	M-PVR	M-PVR	M-PVR	M-PVR	
14.3.1	General PVR recording	M-PVR	M-PVR	M-PVR	M-PVR	M-PVR	M-PVR	
14.3.2	ESG/EPG recording programming	M-PVR	M-PVR	M-PVR	M-PVR	M-PVR	M-PVR	
14.3.3	Series recording	M-PVR	M-PVR	M-PVR	M-PVR	M-PVR	M-PVR	
14.3.4	Split recordings	M-PVR	M-PVR	M-PVR	M-PVR	M-PVR	M-PVR	
14.3.5	Recommended events	M-PVR	M-PVR	M-PVR	M-PVR	M-PVR	M-PVR	
14.3.6	Alternative instance	M-PVR	M-PVR	M-PVR	M-PVR	M-PVR	M-PVR	
14.3.7	Accurate Recording	M-PVR	M-PVR	M-PVR	M-PVR	M-PVR	M-PVR	
14.3.8	Simultaneous recording	M-PVR	M-PVR	M-PVR	M-PVR	M-PVR	M-PVR	
14.3.9	Complete recording	M-PVR	M-PVR	M-PVR	M-PVR	M-PVR	M-PVR	
14.3.10	Trailer booking/Promotional Linking (optional)	M-PVR	M-PVR	M-PVR	M-PVR	M-PVR	M-PVR	
14.3.11	Back-to-back recording	M-PVR	M-PVR	M-PVR	M-PVR	M-PVR	M-PVR	
14.3.12	Timeshift recording	M-PVR	M-PVR	M-PVR	M-PVR	M-PVR	M-PVR	
14.3.13	Late Recording	M-PVR	M-PVR	M-PVR	M-PVR	M-PVR	M-PVR	
14.3.14	Manual recording	M-PVR	M-PVR	M-PVR	M-PVR	M-PVR	M-PVR	
14.3.15	One touch recording (OTR)	M-PVR	M-PVR	M-PVR	M-PVR	M-PVR	M-PVR	
14.3.16	Automatic conflict handling	M-PVR	M-PVR	M-PVR	M-PVR	M-PVR	M-PVR	
14.3.17	Maximum length of recordings	M-PVR	M-PVR	M-PVR	M-PVR	M-PVR	M-PVR	
14.3.18	Recording of recently removed recordings	M-PVR	M-PVR	M-PVR	M-PVR	M-PVR	M-PVR	
14.3.19	Recording of parallel broadcast and simulcast	M-PVR	M-PVR	M-PVR	M-PVR	M-PVR	M-PVR	
14.3.20	NorDig Record Lists recording functionality	M-PVR	M-PVR	M-PVR	M-PVR	M-PVR	M-PVR	
14.4	Playback	M-PVR	M-PVR	M-PVR	M-PVR	M-PVR	M-PVR	
14.4.1	General	M-PVR	M-PVR	M-PVR	M-PVR	M-PVR	M-PVR	
14.4.2	Replay/Playback - trick modes	M-PVR	M-PVR	M-PVR	M-PVR	M-PVR	M-PVR	
14.4.3	Relative Synchronisation	M-PVR	M-PVR	M-PVR	M-PVR	M-PVR	M-PVR	
14.4.4	Simultaneous recording and playback	M-PVR	M-PVR	M-PVR	M-PVR	M-PVR	M-PVR	
14.4.5	Complete service playback	M-PVR	M-PVR	M-PVR	M-PVR	M-PVR	M-PVR	
14.4.6	Resume Playback	M-PVR	M-PVR	M-PVR	M-PVR	M-PVR	M-PVR	
14.4.7	NorDig Record Lists management and playback functionality	M-PVR	M-PVR	M-PVR	M-PVR	M-PVR	M-PVR	
15	IRD System Software and API	---	---	---	---	---	---	
15.1	NorDig Basic	M	M	---	---	---	---	
15.2	NorDig Hybrid	---	---	M	M	M	M	
16	USER PREFERENCES	---	---	---	---	---	---	
16.1	General	M	M	M	M	M	M	
16.2	User Preference Settings	M	M	M	M	M	M	
16.2.1	General User Preference Settings	M	M	M	M	M	M	
16.2.2	Video User Preference Settings	M	M	M	M	M	M	
16.2.3	Audio User Preference Settings	M	M	M	M	M	M	
16.2.4	Subtitling User Preference Settings	M	M	M	M	M	M	

