



NorDig Unified Test plan, ver 2.6.0

# **NorDig Unified Test Plan**

for

## **Integrated Receiver Decoders**

**for use in cable, satellite, terrestrial and IP-based networks**



<b>Part I – Introduction.....</b>	<b>9</b>
<b>1 Document History.....</b>	<b>10</b>
<b>2 References .....</b>	<b>11</b>
<b>3 Background.....</b>	<b>11</b>
<b>4 NorDig compliance testing .....</b>	<b>12</b>
<b>5 Test specifications for NorDig compliance.....</b>	<b>12</b>
<b>6 Testing and test report for NorDig compliance .....</b>	<b>12</b>
<b>6.1 Test item.....</b>	<b>13</b>
<b>6.2 List of Abbreviations .....</b>	<b>13</b>
<b>Part II - Test Cases .....</b>	<b>17</b>
<b>1 Introduction - Test Cases.....</b>	<b>18</b>
<b>2 Test Plan for NorDig - Test Cases.....</b>	<b>26</b>
<b>2.1 Task 1: Satellite tuner and demodulator.....</b>	<b>26</b>
2.1.1 QEF Quality Measurement Methods.....	26
2.1.2 Test cases .....	28
Task 1:1 General .....	28
Task 1:2 General .....	29
Task 1:3 Quality reception detector .....	29
Task 1:4 Symbol and FEC-rate (DVB-S2).....	29
Task 1:5 Input Frequency Range/Tuning range .....	31
Task 1:6 Tuning/ Scanning Procedures (with NIT) .....	32
Task 1:7 Tuning/ Scanning Procedures (without NIT) .....	32
Task 1:8 Control signals.....	33
Task 1:9 Demodulation (DVB-S2) .....	34
Task 1:10 RF Input Connector and Output Connector (option).....	36
Task 1:11 Input Signal Level .....	36
Task 1:12 Power Supply and Control Signal (to RF unit).....	38
Task 1:13 Power Supply and Control Signal (to single-channel RF unit) .....	39
Task 1:14 Performance: Digital interference .....	40
<b>2.2 Task 2: Cable Tuner and Demodulator .....</b>	<b>43</b>
2.2.1 QEF Quality Measurement Methods.....	43
2.2.2 Test cases .....	44
Task 2:1 General .....	44
Task 2:2 General .....	44
Task 2:3 Quality reception detector .....	45
Task 2:4 RF Characteristics: Input frequency range and input level, Digital channels.....	45
Task 2:5 RF Characteristics: Symbol rate and modulation .....	46
Task 2:6 RF Characteristics: Input impedance.....	47
Task 2:7 RF bypass .....	48
Task 2:8 Tuning/Scanning procedure (Automatic scan based on NIT) .....	48
Task 2:9 Tuning/Scanning procedure (Manual scan).....	49
Task 2:10 Tuning/Scanning procedure (Original_network_id, transport_stream_id and service_id triplet support) .....	50
Task 2:11 Tuning/Scanning procedure – Network default values.....	51
Task 2:12 Tuning/Scanning procedure – Factory default values .....	52
Task 2:13 Total input power .....	52
Task 2:14 RF Performance - C/N for Reference BER .....	53
Task 2:15 RF Performance - C/N with echo .....	54
Task 2:16 Performance Data: Noise figure .....	56
Task 2:17 RF Performance - Image Channel .....	58
Task 2:18 RF Performance – Digital Adjacent Channel .....	59
Task 2:19 RF Performance – Analog Adjacent Channel .....	60
Task 2:20 LO leakage .....	62
Task 2:21 Spurious emission.....	62
Task 2:22 Radiation .....	63
<b>2.3 Task 3: Terrestrial Tuner and Demodulator .....</b>	<b>64</b>
2.3.1 Test equipment summary .....	64
2.3.2 QEF Quality Measurement Methods.....	64
2.3.3 Bitrates .....	77
2.3.4 Receiver operability in SFN.....	78

2.3.5 0dB echo .....	79
2.3.6 Conditions for analogue TV .....	79
2.3.7 Summary of DVB-T2 modes in DVB-T2 test tasks .....	80
2.3.8 Stream packet structure in Receiver Buffer Model (RBM) tests for DVB-T2 .....	86
2.3.9 Test cases .....	87
2.3.9.1 Test cases – DVB-T IRD .....	87
Task 3:1 General .....	87
Task 3:2 General .....	87
Task 3:3 Quality reception detector .....	88
Task 3:4 Frequencies: Center frequencies .....	88
Task 3:5 Frequencies: Frequency offset .....	92
Task 3:6 Frequencies: Signal bandwidths .....	93
Task 3:7 Modes .....	95
Task 3:8 Tuning/Scanning Procedure: General .....	96
Task 3:9 Tuning/Scanning Procedures: Basic status check .....	97
Task 3:10 Tuning/Scanning Procedures: Automatic channel search for the same service bouquet .....	98
Task 3:11 Tuning/Scanning: Automatic channel search for different service bouquets .....	103
Task 3:12 Tuning/Scanning Procedures: Manual Channel Search .....	105
Task 3:13 Verification of Signal Strength Indicator (SSI) .....	107
Task 3:14 Verification of Signal Quality Indicator (SQI) .....	110
Task 3:15 Changes In Modulation Parameters .....	113
Task 3:16 RF input connector .....	115
Task 3:17 RF output connector .....	115
Task 3:18 Performance: BER vs C/N verification .....	116
Task 3:19 Performance: C/N performance on Gaussian channel .....	118
Task 3:20 Performance: C/N performance on 0dB echo channel .....	121
Task 3:21 Performance: Minimum receiver signal input levels on Gaussian channel .....	122
Task 3:22 Performance: Minimum IRD Signal Input Levels on 0dB echo channel .....	124
Task 3:23 Performance: Noise figure on Gaussian channel .....	127
Task 3:24 Performance: Maximum Receiver Signal Input Levels .....	128
Task 3:25 Performance: Immunity to “digital” signals in Other Channels .....	130
Task 3:26 Performance: Immunity to “LTE 700 MHz” signals in Other Channels .....	132
Task 3:27 Performance: Immunity to “LTE 800 MHz” signals in Other Channels .....	134
Task 3:28 Performance: Performance in Time-Varying Channels .....	136
Task 3:29 Performance: Synchronisation for varying echo power levels in SFN .....	138
Task 3:30 Performance: C/(N+I) Performance in SFN for more than one echo .....	140
Task 3:31 Performance: C/(N+I) Performance in SFN inside the guard interval .....	143
Task 3:32 Performance: C/(N+I) Performance in SFN outside the guard interval .....	149
2.3.9.2 Test cases – DVB-T2 .....	151
Task 3:33 DVB-T2: Frequencies: Center frequencies .....	151
Task 3:34 DVB-T2: Frequencies: Frequency offset .....	155
Task 3:35 DVB-T2: Frequencies: Signal bandwidths .....	156
Task 3:36 DVB-T2: Modes .....	158
Task 3:37 DVB-T2: MISO .....	162
Task 3:38 DVB-T2: Input Mode B (multiple PLPs) .....	164
Task 3:39 DVB-T2: Input Mode B (multiple PLPs and common PLP) .....	165
Task 3:40 DVB-T2: Input Mode B (RBM for TDI) .....	166
Task 3:41 DVB-T2: Input Mode B (RBM for DJB) .....	167
Task 3:42 DVB-T2: Input Mode B (RBM when FEF present) .....	169
Task 3:43 DVB-T2: Normal mode (NM) .....	171
Task 3:44 DVB-T2: Input Mode A (zero power FEF present) .....	172
Task 3:45 DVB-T2: Input Mode A (RBM when FEF present) .....	173
Task 3:46 DVB-T2: Auxiliary streams .....	175
Task 3:47 DVB-T2: Reception of version 1.1.1 .....	176
Task 3:48 DVB-T2: Tuning/Scanning Procedures: Automatic channel search for the same service bouquet .....	177
Task 3:49 DVB-T2: Tuning/Scanning Procedures: Basic status check .....	182
Task 3:50 DVB-T2: Verification of Signal Strength Indicator (SSI) .....	183

Task 3:51 DVB-T2: Verification of Signal Quality Indicator (SQL).....	186
Task 3:52 DVB-T2: Changes In Modulation Parameters .....	189
Task 3:53 DVB-T2: Time interleaving .....	191
Task 3:54 DVB-T2: Input/Output Data Formats.....	192
Task 3:55 DVB-T2: Performance: BER vs C/N verification .....	193
Task 3:56 DVB-T2: Performance: C/N performance on Gaussian channel.....	194
Task 3:57 DVB-T2: Performance: C/N performance on 0dB echo channel .....	197
Task 3:58 DVB-T2: Performance: Minimum receiver signal input levels on Gaussian channel.....	198
Task 3:59 DVB-T2: Performance: Minimum IRD Signal Input Levels on 0dB echo channel.....	201
Task 3:60 DVB-T2: Performance: Receiver noise figure on Gaussian channel .....	203
Task 3:61 DVB-T2: Performance: Maximum Receiver Signal Input Levels .....	204
Task 3:62 DVB-T2: Performance: Immunity to “digital” signals in Other Channels.....	206
Task 3:63 DVB-T2: Performance: Immunity to “LTE 700 MHz” signals in Other Channels.....	209
Task 3:64 DVB-T2: Performance: Immunity to “LTE 800 MHz” signals in Other Channels.....	212
Task 3:65 DVB-T2: Performance: Performance in Time-Varying Channels .....	213
Task 3:66 DVB-T2: Performance: Synchronisation for varying echo power levels in SFN.....	216
Task 3:67 DVB-T2: Performance: C/(N+I) Performance in SFN for more than one echo .....	218
Task 3:68 DVB-T2: Performance: C/(N+I) Performance in SFN inside the guard interval .....	222
Task 3:69 DVB-T2: Performance: C/(N+I) Performance in SFN outside the guard interval .....	228
<b>2.4 Task 4: IP-Based Front-end .....</b>	<b>230</b>
<b>2.5 Task 5: MPEG2 demultiplexer .....</b>	<b>231</b>
Task 5:1 SI utilization .....	231
Task 5:2 CA descriptor interpretation .....	231
Task 5:3 Maximum transport stream data rate .....	231
Task 5:4 Number of elementary streams.....	232
Task 5:5 Section filtering .....	233
Task 5:6 Variable Bitrate Elementary Streams .....	233
Task 5:7 Mixture of SD and HD services .....	234
Task 5:8 Descrambler Performance .....	235
Task 5:9 System clock recovery.....	236
<b>2.6 Task 6: Video .....</b>	<b>237</b>
Task 6:1 Video Decoder - General.....	237
Task 6:2 Video Decoder – Resolutions and Frame rates.....	238
Task 6:3 Up-sampling/Up-conversion .....	239
Task 6:4 Video Decoder - Colorimetry.....	240
Task 6:5 Video Decoder - Dynamic changes in video stream .....	241
Task 6:6 Video Decoder - AVC still picture .....	242
Task 6:7 Minimum video bandwidth .....	243
Task 6:8 Frame cropping .....	244
Task 6:9 Overscan.....	245
Task 6:10 High Definition Video Output and Display.....	246
Task 6:11 Down-conversion of High Definition Video for Standard Definition output.....	246
Task 6:12 16:9 displayed on 4:3 monitors .....	247
Task 6:13 Displaying 4:3 Material on 16:9 Monitors .....	248
Task 6:14 Rescaling for HbbTV application.....	248
<b>2.7 Task 7: Audio .....</b>	<b>249</b>
Task 7:1 Audio User Preference Settings.....	249
Task 7:2 MPEG-1 Layer II: Requirements .....	249
Task 7:3 MPEG-1 Layer II: Analogue audio output .....	249
Task 7:4 MPEG-1 Layer II: HDMI output interface.....	250
Task 7:5 MPEG-1 Layer II: S/PDIF output interface .....	251
Task 7:6 AC-3: Requirements.....	252
Task 7:7 AC-3: Analogue audio output .....	254
Task 7:8 AC-3: HDMI output and HDMI ARC interface.....	255
Task 7:9 AC-3: S/PDIF output interface .....	256
Task 7:10 AC-3: Metadata .....	257
Task 7:11 E-AC-3: Requirements .....	257
Task 7:12 E-AC-3: Analogue audio output.....	258
Task 7:13 E-AC-3: HDMI output and HDMI ARC interface .....	259

Task 7:14 E-AC-3: S/PDIF output interface .....	261
Task 7:15 E-AC-3: Metadata .....	262
Task 7:16 HE AAC: Requirements .....	263
Task 7:17 HE AAC: Analogue audio output.....	264
Task 7:18 HE AAC: HDMI output and HDMI ARC interface .....	265
Task 7:19 HE AAC: S/PDIF output interface .....	266
Task 7:20 HE AAC: Metadata .....	268
Task 7:21 Audio prioritizing - Audio language support .....	269
Task 7:22 Audio Prioritising – audio format and stream type .....	270
Task 7:23 Audio Prioritising – audio type .....	272
Task 7:24 Audio Prioritising – audio format signaling missing.....	274
Task 7:25 Audio video synchronization.....	275
Task 7:26 Adjustment of Video/audio-delay.....	277
Task 7:27 Audio handling when changing service or audio format .....	278
Task 7:28 Dynamic changes in audio components .....	278
Task 7:29 Audio descriptors .....	280
Task 7:30 Clean audio.....	280
Task 7:31 Supplementary audio.....	281
Task 7:32 IRD Internal Reference Level .....	282
Task 7:33 Loudness levels - Audio Output Levels .....	283
<b>2.8 Task 8: Teletext and subtitling .....</b>	<b>286</b>
Task 8:1 Subtitling - user preferences.....	286
Task 8:2 Subtitling - Only display subtitling if match language in user preferences .....	286
Task 8:3 Subtitling - Temporary changes to subtitling settings .....	287
Task 8:4 Subtitling – Subtitling mode (Normal and Hard of hearing subtitling) .....	288
Task 8:5 Subtitling – DVB Subtitling and subtitling priority (DVB/EBU) .....	289
Task 8:6 Teletext - Simultaneous EBU Teletext and HbbTV Digital Teletext.....	290
Task 8:7 Subtitling - coexistent with HbbTV applications .....	291
Task 8:8 Teletext – EBU Teletext level 1.5 .....	292
Task 8:9 Teletext - decoding method(VBI) .....	293
Task 8:10 Teletext decoding method(OSD).....	293
Task 8:11 Teletext – teletext pages .....	294
Task 8:12 Teletext – teletext pages - cache.....	295
Task 8:13 Subtitling – teletext subtitling .....	296
Task 8:14 Subtitling – DVB Subtitling .....	297
<b>2.9 Task 9: Interfaces and Signal Levels .....</b>	<b>300</b>
Task 9:1 Two-way Interface .....	300
Task 9:2 SCART Interface.....	300
Task 9:3 HDMI interface – HD Ready .....	301
Task 9:4 HDMI interface – EDID information .....	302
Task 9:5 HDMI interface – Original format .....	303
Task 9:6 HDMI – Manual setting for resolution .....	303
Task 9:7 HDMI – Signal protection.....	304
Task 9:8 Analogue video interface(Optional).....	306
Task 9:9 Remote Control Function Keys .....	306
Task 9:10 Remote Control Function Keys for PVR.....	307
Task 9:11 Remote Control Key event mapping for NorDig Hybrid .....	308
<b>2.10 Task 10: Interfaces for Conditional Access .....</b>	<b>309</b>
Task 10:1 Use of Common Interface .....	309
Task 10:2 Smart Card Interface .....	309
<b>2.11 Task 11: The System Software Update.....</b>	<b>311</b>
2.11.1 Test equipment summary .....	311
2.11.2 Test cases .....	313
Task 11:1 IRD System software update using DVB SSU simple profile.....	313
Task 11:2 IRD System software update using DVB SSU enhanced profile - scheduling.....	316
Task 11:3 IRD System software update using DVB SSU Notifications update type 0x4.....	319
Task 11:4 SSU end user functionality .....	321
Task 11:5 Common interface plus (CI+) CAM module system software update .....	322
<b>2.12 Task 12: Performance .....</b>	<b>324</b>

Task 12:1 Video performance .....	324
Task 12:2 Audio performance.....	324
Task 12:3 Zapping time .....	325
<b>2.13 Task 13: Service Information.....</b>	<b>327</b>
2.13.1 General.....	327
Task 13:1 SI: General.....	327
Task 13:2 SI: General – Undefined data structures.....	327
Task 13:3 SI: General – ‘Actual’ and ‘Other’ tables.....	327
Task 13:4 SI: SI data available through an API.....	328
Task 13:5 SI: Text strings and field size of the SI descriptor.....	328
2.13.2 Static PSI/SI data.....	329
Task 13:6 NIT_actual – frequency_list_descriptor .....	329
Task 13:7 NIT_actual – Missing terrestrial_system_delivery_descriptor.....	330
Task 13:8 NIT_actual – Missing T2_delivery_system_descriptor.....	332
Task 13:9 SDT_actual service_descriptor and CA_identifier_descriptor .....	333
2.13.3 Quasi static PSI/SI data.....	334
Task 13:10 Quasi static update of SDT_actual .....	334
Task 13:11 Quasi-static update of SDT_actual – linkage to NorDig simulcast replacement service.....	335
Task 13:12 Quasi-static update of NIT_actual – Linkage to an information service about the network	337
Task 13:13 Quasi-static update of NIT_actual – Linkage to EPG service .....	338
Task 13:14 Quasi-static update of NIT_actual – Linkage to TS that carries EIT sch information for all services.....	339
Task 13:15 Quasi-static update of NIT_actual – Linkage to System Software Download service .....	339
2.13.4 Dynamic PSI/SI data.....	340
Task 13:16 Dynamic update of SDT_actual running status and linkage to a service replacement service .....	340
Task 13:17 Dynamic update of EIT actual/other p/f.....	341
Task 13:18 Dynamic update of EIT_actual p/f CA_identifier_descriptor .....	342
Task 13:19 Dynamic update of EIT actual/other p/f short_event_descriptor, extended_event_descriptor and content_descriptor .....	343
Task 13:20 Dynamic update of EIT actual/other p/f content descriptor and component_descriptor .....	345
Task 13:21 Dynamic update of EIT actual/other p/f parental_rating_descriptor .....	347
Task 13:22 Dynamic update of EIT actual/other p/f and schedule in ESG using linkage.....	348
Task 13:23 Dynamic update of EIT actual/other p/f and schedule in ESG.....	350
Task 13:24 PMT Descriptors - General .....	352
Task 13:25 PMT Descriptors – teletext pages, teletext subtitling and DVB subtitling.....	353
Task 13:26 Dynamic update of PMT PID values.....	354
Task 13:27 Dynamic update of PMT-Component priority (stream type) .....	355
Task 13:28 Dynamic update of PMT - Content_Protection_descriptor .....	357
Task 13:29 Dynamic update of TDT/TOT.....	358
<b>2.14 Task 14: Navigator.....</b>	<b>362</b>
Task 14:1 Navigator: General .....	362
2.14.1 Static PSI/SI data.....	363
Task 14:2 Service list - General requirement.....	363
Task 14:3 Service list – service types and categories.....	363
Task 14:4 Service list – use of NIT_other and SDT_other .....	365
Task 14:5 Service list - Inconsistent of SDT_actual and NIT_actual information.....	367
Task 14:6 Service list – NIT_actual interpretation.....	368
Task 14:7 Service list – NIT_actual original_network_ID .....	369
Task 14:8 Service list – NIT_actual network_ID.....	370
Task 14:9 Service list – Inconsistent SDT_actual/NIT_actual and SDT_other/NIT_other.....	371
Task 14:10 Service list – Handling of multiple channel lists from same networks and NorDig LCD....	372
Task 14:11 Service list – Simultaneous transmission of LCD v1 and v2 .....	375
Task 14:12 Service list – Simultaneous reception of multiple networks and NorDig LCD.....	377
Task 14:13 Service list - Priority of LCN between SD and HDTV services.....	378
2.14.2 Quasi static PSI/SI data.....	381
Task 14:14 Quasi-static update of service list – service addition.....	381
Task 14:15 Quasi-static update of service list – non-visible data service addition .....	382
Task 14:16 Quasi-static update of service list – services moved between different transport streams ...	383

Task 14:17 Quasi-static update of service list – service remove.....	385
Task 14:18 Quasi-static update of service list from NIT_actual for non-existing multiplexers.....	386
Task 14:19 Quasi-static update of service list from NIT_actual for removing a multiplex .....	388
Task 14:20 Quasi-static update of NorDig LCN v1 .....	389
Task 14:21 Quasi-static update of NorDig LCN v2.....	391
<b>2.15 Task 15: PVR Functionality.....</b>	<b>394</b>
Task 15:1 Recording File System .....	394
Task 15:2 Recording capacity .....	394
Task 15:3 Deletion of the recordings .....	395
Task 15:4 Failed and incomplete recordings.....	395
Task 15:5 File system intact after update.....	396
Task 15:6 Limitations in recorded content – no extraction .....	397
Task 15:7 Limitations in recorded content – downscaling of the HD content to the removable media..	397
Task 15:8 Disk Management.....	398
Task 15:9 General PVR recording – bitrates.....	398
Task 15:10 General PVR recording – service types.....	399
Task 15:11 ESG/EPG recording programming – individual events without CRID .....	400
Task 15:12 ESG/EPG recording programming – individual event with CRID.....	402
Task 15:13 ESG/EPG recording programming – individual event with CRID – same event recording.	402
Task 15:14 ESG/EPG recording programming – series.....	403
Task 15:15 Split recordings .....	404
Task 15:16 Split recordings- dynamic update of EIT .....	405
Task 15:17 Recommended events.....	406
Task 15:18 Alternative Recording .....	407
Task 15:19 Accurate Recording – EIT information present.....	408
Task 15:20 Accurate Recording – EIT information missing.....	409
Task 15:21 Accurate Recording – Loss of signal.....	410
Task 15:22 Accurate Recording – EIT update in stand-by .....	411
Task 15:23 Simultaneous recording – OTR and viewing.....	412
Task 15:24 Simultaneous recording – Scheduled recording and viewing.....	413
Task 15:25 Simultaneous recording – OTR and time-shift .....	413
Task 15:26 Simultaneous recording – Scheduled recording and time-shift .....	414
Task 15:27 Simultaneous recording and playback .....	415
Task 15:28 Back-to-back recordings – Static EIT information.....	415
Task 15:29 Back-to-back recordings – Changes in EIT information .....	417
Task 15:30 Timeshift recording .....	419
Task 15:31 Manual recording .....	419
Task 15:32 Manual recording – Changes in TDT/TOT .....	420
Task 15:33 One Touch Recording (OTR).....	421
Task 15:34 Automatic Conflict Handling – During programming .....	422
Task 15:35 Automatic Conflict Handling – After programming .....	423
Task 15:36 Maximum length of recordings .....	424
Task 15:37 Recording of parallel broadcast.....	425
Task 15:38 Playback - General .....	425
Task 15:39 Replay/Playback – trick modes in playback.....	426
Task 15:40 Replay/Playback – trick modes in timeshift.....	427
Task 15:41 Relative synchronisation .....	428
Task 15:42 Full service playback – Dynamic update of PMT audio language .....	428
Task 15:43 Full service playback – Dynamic update of PMT audio format.....	430
Task 15:44 Full service playback – Dynamic update of PMT audio type.....	431
Task 15:45 Full service playback – Dynamic update of PMT subtitling language.....	433
Task 15:46 Full service playback – Subtitling for the hard-of-hearing.....	435
Task 15:47 Full service playback – Dynamic update of PMT subtitling type .....	436
Task 15:48 Full service playback – Subtitling synchronization.....	437
Task 15:49 Full service playback – Subtitling synchronization in time-shift .....	438
Task 15:50 Full service playback – Dynamic update of PMT video and audio PIDs .....	439
Task 15:51 Full service playback – Dynamic update of video aspect ratio .....	441
Task 15:52 Full service playback – Dynamic update of PMT CA status.....	442
Task 15:53 Dynamic changes in video stream in playback.....	443



NorDig

Task 15:54 Parental lock during playback .....	444
Task 15:55 Maintaining scheduled recordings after network update .....	445
Task 15:56 User actions disturbing the recording .....	446
<b>2.16 Task 16: IRD System Software and API.....</b>	<b>448</b>
2.16.1 Introduction .....	448
2.16.2 List of test cases .....	449
2.16.3 Test cases .....	450
Task 16:1 – 16:50.....	450
Task 16:51 HbbTV Global setting .....	450
Task 16:52 – 16:59 (es.TDThibrida and fr.HDForum tests).....	451
Task 16:60 Teletext - Simultaneous EBU Teletext and HbbTV Digital Teletext (8:6) .....	451
Task 16:61 Subtitling - coexistent with HbbTV applications (8:7).....	452
Task 16:62 Remote Control Key event mapping for NorDig Hybrid (9:11).....	452
<b>2.17 Task 17: User Preferences.....</b>	<b>454</b>
Task 17:1 Stored preferences .....	454
Task 17:2 Deletion of service lists .....	455
Task 17:3 Reset to factory mode.....	455
<b>AnnexA: NorDig Network Custodians .....</b>	<b>457</b>





## **Part I – Introduction**



## 1 Document History

Version	Date	Comments
Ver 1.0	11.2004	This is the first approved version of the complete NorDig Unified Test specification
Ver. 1.0.3	03.2007	This is the updated version of the complete NorDig Unified Test specification. This release is compliant with the NorDig Unified specification ver. 1.0.3
Ver 2.0	06.2008	This is the updated version of the complete NorDig Unified Test specification. This release is compliant with the NorDig Unified specification ver. 2.0. It also reflects that the NorDig logo is no more offered.
Ver. 2.2.1	01.2012	This is the updated version of the complete NorDig Unified Test specification. This release is compliant with the NorDig Unified specification ver. 2.2.1.
Ver. 2.2.2	11.2012	This is the updated version of the complete NorDig Unified Test specification. This release updated some DVB-S, DVB-T/T2 and PVR test cases. This release is compliant with the NorDig Unified specification ver. 2.2.1.
Ver 2.4	10.2013	This is the updated version of the complete NorDig Unified Test plan. This release is compliant with the NorDig Unified specification ver. 2.4.  Main changes in this release are: <ul style="list-style-type: none"><li>• Change of document name from “test specification” to “test plan”</li><li>• LTE interferer for DVB-T and DVB-T2</li><li>• Test cases for RBM in case of reception of DVB-T2 signals. Tests are based on DVB V&amp;V work and harmonized with Ebook and Dbook.</li><li>• Change of DVB-T2 version from 1.1.1 to 1.2.1</li><li>• Reception of DVB-T2 v1.1.1 signals</li><li>• Video, Audio and Subtitling test case updates due removing M2 and M4 requirements.</li><li>• MHP related test cases removed</li></ul>
Ver 2.5.0	01.2016	This is the updated version of the complete NorDig Unified Test plan. This release is compliant with the NorDig Unified specification ver. 2.5.1.  Main changes in this release are: <ul style="list-style-type: none"><li>• Test case and chapter numbering changed</li><li>• Test cases for DVB-T and T2 SSI updated</li><li>• Test cases for DVB-C updated</li><li>• Test cases for PVR updated</li><li>• Test cases for Audio and Video updated</li></ul>
Ver 2.6.0	10.2017	This is the updated version of the complete NorDig Unified Test plan. This release is compliant with the NorDig Unified specification ver. 2.6.0.  Main changes in this release are: <ul style="list-style-type: none"><li>• Test cases for DVB-T/T2 for Analog interference removed</li><li>• Test cases for DVB-T/T2 for LTE interference 800 MHz updated and added for LTE 700 MHz</li><li>• Test cases for IRD System Software and API added</li><li>• Test cases for DVB-T/T2 channel search updated</li><li>• Test cases for DVB-SSU updated</li><li>• Some test cases for PVR functionality updated</li></ul>

## 2 References

This test specification is related to the following documents:

- [1] NorDig Unified Requirements for Integrated Receiver Decoders, Version 2.6 January 2017.
- [2] NorDig Rules of Operation for NorDig Unified receiver networks, ver. 2.5 October 2016.
- [3] HbbTV Test Suite, the most recent released version published by HbbTV applicable to IRD implementing. The most recent released version published by HbbTV refers here to the latest version that was available up to 9 month before the IRD is released/launched, in order to give manufacture time for their QA verification and test process. (Note, HbbTV organisation normally only keep latest version available and at time of writing the latest version is 9.2.0)
- [4] The DVB-T2 Reference Streams, DVB-T2 Verification & Validation Working Group, ver 1.1 (11<sup>th</sup> August, 2011),

## 3 Background

The NorDig group represents broadcasters and network operators in the Nordic countries. The members have agreed on common minimum decoder specifications and a migration plan towards the use of decoders that satisfy these requirements. For further info about NorDig, please see [www.nordig.org](http://www.nordig.org).

The various members of NorDig are independent of each other, but intend to transmit to IRDs that satisfy the specified common minimum requirements. The various networks may in addition specify network specific requirements.

Common test specifications are established in order to ensure that decoders comply with the common minimum requirements. Additional test specifications may apply for individual networks, especially networks with access-controlled transmissions.

The NorDig specifications are contained in the NorDig Unified specification [1] which covers and includes the following profiles; NorDig Basic and NorDig Hybrid. Figure 1 illustrate the relationships between the various NorDig profiles.

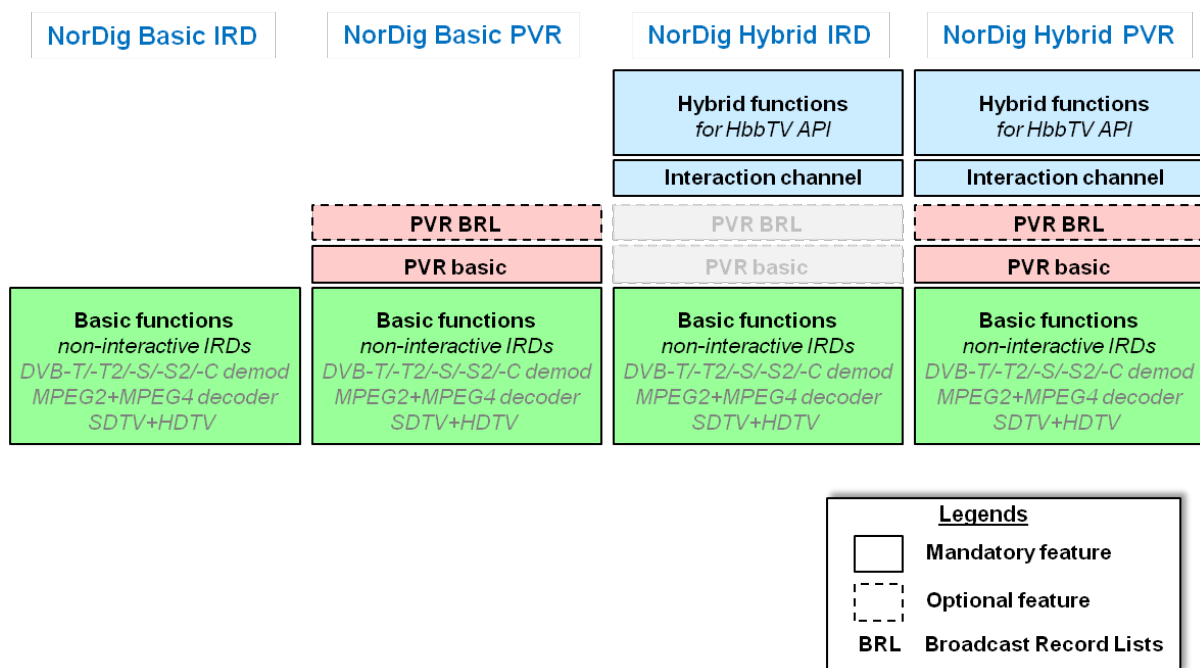

Figure 1 The NorDig profiles and the main building blocks.



## 4 NorDig compliance testing

The NorDig Verification Test is open for all IRD manufacturers that want to claim that they have IRD products that comply with the NorDig IRD requirements. The IRD manufacturer can claim compliance with one or more NorDig profile(s), provided that

- (i) the IRD product complies with the NorDig profile(s)[1] referred to and,
- (ii) the IRD product passes the tests specified in this document.

The NorDig Verification Test shall ensure compliance with the NorDig requirements and NorDig transmissions, and comes in addition to the regular factory testing for general quality and functionality control.

In addition to the common NorDig requirements, the IRD-product has to comply with additional requirements and pass additional tests in case it is intended for use in a network that provides access controlled services. The additional requirements and tests will be available from the relevant Network Custodian.

The IRD Manufacturer shall furthermore contact the relevant Network Custodian(s) in case the IRD product shall be verified for networks with access controlled services. The relevant Network Custodian(s) will provide Network specific requirements (additional to the specified Unified NorDig Requirements) and the corresponding test specifications. Such further handling has to be agreed between the IRD Manufacturer and the relevant Network Custodian (Annex A).

## 5 Test specifications for NorDig compliance

The NorDig Unified test plan consists of test cases and the defined test procedures in each test case are only illustrations of the test setup and the manufacturer can use different setup to run the test cases. If other, than illustrated, test setup is used the manufactures shall describe used test setup in the test report. The defined test sets may not cover all NorDig Unified Requirements [1].

If any requirement in this test specification is in contradictory with the requirement in the specification [1], the requirement in specification [1] is the valid one.

## 6 Testing and test report for NorDig compliance

A Test Report should be made available to show compliance with the common NorDig requirements. Each individual test case should be performed; test results and conformity should be reported and signed.

In each test task a IRD profile is given. This means for which type of receiver the test task is relevant to perform. Following table specifies the abbreviations.

<b>IRD profile</b>	<b>Test task is dedicated for type receiver</b>
Basic	IRD implements NorDig Basic or NorDig Hybrid profile
Hybrid	IRD implements NorDig Hybrid profile
IRD	IRD is either IDTV or STB
IDTV	IRD is either IDTV, CarTV or PCTV
STB	IRD is a STB
FE	IRD implement at least one of the following front-ends: DVB-T,DVB-T2,DVB-C,DVB-S or DVB-S2
DVB-C	IRD with DVB-C tuner
DVB-S	IRD with DVB-S tuner
DVB-S2	IRD with DVB-S2 tuner
DVB-T	IRD with DVB-T tuner
DVB-T2	IRD with DVB-T2 tuner
PVR	IRD implements PVR functionality

In case that the test result indicates a non-compliance (with the specified requirement) the level of the non-compliance shall be evaluated and indicated by ticking the corresponding “box” in the conformity field. If such non-compliance can be removed by an upgrade of the IRD software, this shall be indicated by ticking the correct commentary field for the individual test. The manufacturer should describe the non-compliance and plans to correct it in the “Comments “ row.

The Information specified for the "Test item" should be provided, see section 6.1.

## 6.1 Test item

The information of the Test Item shall be inserted to the following table. The tests shall be performed with the same IRD model (HW/SW) in all test cases.

**Table 6.1 Test Item**

<b>Test Item</b>	
<b>Manufacturer:</b>	
<b>Model:</b>	
<b>S/N(s):</b>	
<b>SW version:</b>	
<b>HW version:</b>	
<b>Front-End:</b>	
<b>Demux:</b>	
<b>Processor:</b>	
<b>Memory size:</b>	
<b>NorDig IRD Profile(s):</b>	
<b>Other relevant information:</b>	

Following information shall be entered to Table 6.1:

<b>Manufacturer:</b>	The name of the manufacturer of the tested IRD
<b>Model:</b>	The model (to be deployed to NorDig market) of the tested IRD
<b>S/N(s):</b>	The serial numbers of all IRDs which are used in the tests
<b>SW version:</b>	The SW version of the tested IRD model
<b>HW version:</b>	The HW version of the tested IRD model
<b>Front-End:</b>	The front-end type and model of the tested IRD
<b>Demux:</b>	The Demux type and model of the tested IRD
<b>Processor:</b>	The Processor type and model of the tested IRD
<b>Memory size:</b>	The memory size of the tested IRD
<b>NorDig Profile</b>	The NorDig profile of the tested IRD
<b>Other relevant information:</b>	The other relevant information that the IRD manufacturer feels important

## 6.2 List of Abbreviations

0b	values written in binary (ie with base 2)
0x	values written in hexadecimal (ie with base 16)
AAC	Advanced Audio Codec
AAC-LC	Advanced Audio Codec Low Complexity
AC-3	Audio Codec 3
ACE	Active Constellation Extension
AFC	Automatic Frequency Control
AFD	Active Format Descriptor
AFNOR	Association Francaise de Normalisation
API	Application Programming Interface
ARC	Audio Return Channel (regarding HDMI interface)
AV	Audio (and) Video
BAT	Bouquet Association Table
BCD	Binary Coded Decimal



NorDig

BDR	Broadcast Discovery Record (part of SD&S)
BER	Bit Error Ratio
BOOTP	Bootstrap Protocol
bslbf	bit string, left bit first
C/N	Carrier to Noise ratio
CA	Conditional Access
CAM	Conditional Access Module
CAT	Conditional Access Table
CATV	Community Antenna Television
CEA	Consumer Electronics Association (North American Association)
CENELEC	Comité Européen de Normalisation Electrotechnique
CI	Common Interface
CID	Content Identifier descriptor
CIF	Common Intermediate Format
CIP- CAM	CA-module that complies with the Common Interface Plus specification
CRC	Cyclic Redundancy Check
CRID	Content Reference Identifier
CSO	Composite Second Order
CTB	Composite Triple Beat
CVBS	Composite Video Baseband Signal
D/A	Digital-to-Analogue converter
DAD	Default Authority Descriptor
DAVIC	Digital Audio-Visual Council
dB	decibel
dBFS	dB (relative to) Full Scale
DDS	Display definition segment
DDWG	Digital Display Working Group
DECT	Digital Enhanced Cordless Telecommunications
DHCP	Dynamic Host Configuration Protocol
DSB	Double SideBand
DSM-CC	Digital Storage Media Command and Control
DTS	Digital Theater System (audio codec)
DVB	Digital Video Broadcasting
DVB-C	Digital Video Broadcasting – Cable
DVB-CAM	CA-module that complies with the DVB Common Interface specification
DVB-data	Digital Video Broadcasting – Data Broadcasting
DVB-S	Digital Video Broadcasting – Satellite
DVB-T	DVB-Terrestrial
E-AC-3	Enhanced Audio Codec 3
E-EDID	Enhanced Extended Display Identification Data (regarding HDMI interface)
EBU	European Broadcasting Union
ECCA	European Cable Communications Association
ECL	EuroCableLabs, technical cell of ECCA
EICTA	European Information & Communications Technology Industry Association
EIT	Event Information Table
EITp/f	Event Information Table, present/following tables
EITsch	Event Information Table, schedule tables
EITp	Event Information Table, present table/section of EITp/f
EITf	Event Information Table, following table/section of EITp/f
EPT	Effective Protection Target
EPG	Electronic Program Guide (based on API)
ESG	Event Schedule Guide (without any API)
FEF	Future Extension Frame



NorDig

FFT	Fast Fourier Transform
GAP	Generic Access Protocol
GOP	Group Of Pictures
GPRS	General Packet Radio System
GS	Generic Stream
GSM	Group Special Mobile
HbbTV	Hybrid Broadcast Broadband TV
HDCP	High-bandwidth Digital Content Protection
HDMI	High-Definition Multimedia Interface
HDMI ARC	HDMI Audio Return Channel
HDTV	High Definition Television
HE-AAC	High Efficiency Advanced Audio Codec
HTTP	HyperText Transfer Protocol
iDTV	integrated Digital TV (IRD with display)
IEC	International Electrotechnical Commission
IEEE	Institute for Electrical and Electronic Engineers
IEFT	Internet Engineering Task Force
IGMP	Internet Group Management Protocol
INA	Interactive Network Adapter
IP	Internet Protocol
IRD	Integrated Receiver Decoder
IMI	Instant Metadata Identifier
ISO	International Organisation for Standardisation
JTC	Joint Technical Committee
LCD	Logical Channel Descriptor
LCN	Logical Channel Number
LU	Loudness Units
LUFS	Loudness Units (relative to) Full Scale
L-PCM	Linear Pulse Code Modulation
MAC	Medium Access Control
MPEG	Moving Pictures Expert Group
MPTS	Multi Programme Transport Stream
MTU	Maximum Transfer Unit
NEM	Network Element Management
NIC	Network Interface Card
NIT	Network Information Table
NT	Network Termination in general
NVOD	Near Video On Demand
OSD	On Screen Display
PAL	Phase Alternating Line
PAPR	Peak-toAverage-Power Ratio
PAT	Program Association Table
PCM	Pulse Code Modulation
PLP	Physical Layer Pipe
PID	Packet Identifier
PMT	Program Map Table
PSI	Program Specific Information
PSTN	Public Switched Telephone Network
PCR	Programme Clock Referance
PVR DVR)	Personal Video Recorder, (same as PDR, Personal Digital Recorder, or
QAM	Quadrature Amplitude Modulation
QCIF	Quarter Common Intermediate Format



**NorDig**

QEF	Quasi Error Free
QoS	Quality of Service
QPSK	Quaternary Phase Shift Keying
RF	Radio Frequency
RFC	Request For Comments
RMS	Root Mean Square
RoO	Rules of Operation
rpchof	remainder polynomial coefficients, highest order first
RS	Reed-Solomon
RST	Running Status Table
RTCP	Real-Time Transport Control Protocol
RTP	Real-Time Transport Protocol
RTSP	Real Time Streaming Protocol
S/PDIF	Sony Philips Digital Interface (for digital audio)
SAP	Session Announcement Protocol
SBR	Spectral Band Replication (regarding HE-AAC audio)
SCART	Syndicat des Constructeurs d'Appareils Radiorécepteurs et Téléviseurs (video/audio interface)
SD&S	Service Discovery and Selection
SDT	Service Description Table
SDTV	Standard Definition Television
SFN	Single Frequency Network
SI	Service Information
SMATV	Satellite Master Antenna Television
SNTP	Simple Network Time Protocol
SPTS	Single Programme Transport Stream
ST	Stuffing Table
STB	Set-top box (IRD without display)
SW	Software
TCP	Transmission Control Protocol
TDT	Time and Date Table
TFS	Time Frequency Slicing
TFTP	Tunnelling File Transfer Protocol
TOT	Time Offset Table
TPS	Transmission Parameter Signalling
TRS	Tip Ring Sleeve
TR	Tone Reservation
TS	Transport Stream
TV	Television
TVA	TV Anytime
UHF	Ultra-High Frequency
uimsbf	unsigned integer most significant bit first
UTC	Universal Time, Co-ordinated
VCR	Video Cassette Recorder
VHF	Very-High Frequency
VHS	Video Home System
VoIP	Voice over IP
VPN	Virtual Private Network
VSF	Vestigial SideBand
xDSL	x Digital Subscriber Line
XML	Extensible Markup Language





## **Part II - Test Cases**



NorDig

## 1 Introduction - Test Cases

The NorDig plan specifications Test Cases are grouped into a set of test tasks, covering related tests:

- Task 1: Satellite tuner and demodulator
- Task 2: Cable Tuner and Demodulator
- Task 3: Terrestrial Tuner and Demodulator
- Task 4: IP-Based Front-end
- Task 5: MPEG2 demultiplexer
- Task 6: Video
- Task 7: Audio
- Task 8: Teletext and subtitling
- Task 9: Interfaces and Signal Levels
- Task 10: Interfaces for Conditional Access
- Task 11: The System Software Update
- Task 12: Performance
- Task 13: Service Information
- Task 15: PVR Functionality
- Task 16: IRD System Software and API
- Task 17: User Preferences

Each of the main tasks defined above include a number of sub-tasks.

Table 1 maps the NorDig requirements [1] into the corresponding test tasks and shows the relevance per sub-task for the various NorDig profiles (“shall” indicates a mandatory requirement and a mandatory test).



NorDig

**Table 1A. Task A: Front ends**

NorDig Test Task	NorDig IRD Profile									
	STB	IDTV	Basic	Hybrid	PVR	DVB-S	DVB-S2	DVB-C	DVB-T	DVB-T2
<b>2.1 Task 1: Satellite tuner and demodulator</b>	-	-	-	-	-	-	-	-	-	-
Task 1:1 General	Shall	Shall	Shall	Shall	Shall	Shall	Shall	-	-	-
Task 1:2 General	Shall	Shall	Shall	Shall	Shall	Shall	Shall	-	-	-
Task 1:3 Quality reception detector	Shall	Shall	Shall	Shall	Shall	Shall	Shall	-	-	-
Task 1:4 Symbol and FEC-rate (DVB-S2)	Shall	Shall	Shall	Shall	Shall	Shall	Shall	-	-	-
Task 1:5 Input Frequency Range/Tuning range	Shall	Shall	Shall	Shall	Shall	Shall	Shall	-	-	-
Task 1:6 Tuning/ Scanning Procedures (with NIT)	Shall	Shall	Shall	Shall	Shall	Shall	Shall	-	-	-
Task 1:7 Tuning/ Scanning Procedures (without NIT)	Shall	Shall	Shall	Shall	Shall	Shall	Shall	-	-	-
Task 1:8 Control signals	Shall	Shall	Shall	Shall	Shall	Shall	Shall	-	-	-
Task 1:9 Demodulation (DVB-S2)	Shall	Shall	Shall	Shall	Shall	Shall	Shall	-	-	-
Task 1:10 RF Input Connector and Output Connector (option)	Shall	Shall	Shall	Shall	Shall	Shall	Shall	-	-	-
Task 1:11 Input Signal Level	Shall	Shall	Shall	Shall	Shall	Shall	Shall	-	-	-
Task 1:12 Power Supply and Control Signal (to RF unit)	Shall	Shall	Shall	Shall	Shall	Shall	Shall	-	-	-
Task 1:13 Power Supply and Control Signal (to single-channel RF unit)	Shall	Shall	Shall	Shall	Shall	Shall	Shall	-	-	-
Task 1:14 Performance: Digital interference	Shall	Shall	Shall	Shall	Shall	Shall	Shall	-	-	-
<b>2.2 Task 2: Cable Tuner and Demodulator</b>	-	-	-	-	-	-	-	-	-	-
Task 2:1 General	Shall	Shall	Shall	Shall	Shall	-	-	Shall	-	-
Task 2:2 General	Shall	Shall	Shall	Shall	Shall	-	-	Shall	-	-
Task 2:3 Quality reception detector	Shall	Shall	Shall	Shall	Shall	-	-	Shall	-	-
Task 2:4 RF Characteristics: Input frequency range and input level, Digital channels	Shall	Shall	Shall	Shall	Shall	-	-	Shall	-	-
Task 2:5 RF Characteristics: Symbol rate and modulation	Shall	Shall	Shall	Shall	Shall	-	-	Shall	-	-
Task 2:6 RF Characteristics: Input impedance	Shall	Shall	Shall	Shall	Shall	-	-	Shall	-	-
Task 2:7 RF bypass	Shall	Shall	Shall	Shall	Shall	-	-	Shall	-	-
Task 2:8 Tuning/Scanning procedure (Automatic scan based on NIT)	Shall	Shall	Shall	Shall	Shall	-	-	Shall	-	-
Task 2:9 Tuning/Scanning procedure (Manual scan)	Shall	Shall	Shall	Shall	Shall	-	-	Shall	-	-
Task 2:10 Tuning/Scanning procedure (Original_network_id, transport_stream_id and service_id triplet support)	Shall	Shall	Shall	Shall	Shall	-	-	Shall	-	-
Task 2:11 Tuning/Scanning procedure - Network default values	Shall	Shall	Shall	Shall	Shall	-	-	Shall	-	-
Task 2:12 Tuning/Scanning procedure - Factory default values	Shall	Shall	Shall	Shall	Shall	-	-	Shall	-	-
Task 2:13 Total input power	Shall	Shall	Shall	Shall	Shall	-	-	Shall	-	-
Task 2:14 RF Performance - C/N for Reference BER	Shall	Shall	Shall	Shall	Shall	-	-	Shall	-	-
Task 2:15 RF Performance - C/N with echo	Shall	Shall	Shall	Shall	Shall	-	-	Shall	-	-
Task 2:16 Performance Data: Noise figure	Shall	Shall	Shall	Shall	Shall	-	-	Shall	-	-
Task 2:17 RF Performance - Image Channel	Shall	Shall	Shall	Shall	Shall	-	-	Shall	-	-
Task 2:18 RF Performance - Digital Adjacent Channel	Shall	Shall	Shall	Shall	Shall	-	-	Shall	-	-
Task 2:19 RF Performance - Analog Adjacent Channel	Shall	Shall	Shall	Shall	Shall	-	-	Shall	-	-
Task 2:20 LO leakage	Shall	Shall	Shall	Shall	Shall	-	-	Shall	-	-
Task 2:21 Spurious emission	Shall	Shall	Shall	Shall	Shall	-	-	Shall	-	-
Task 2:22 Radiation	Shall	Shall	Shall	Shall	Shall	-	-	Shall	-	-
<b>2.3 Task 3: Terrestrial Tuner and Demodulator</b>	-	-	-	-	-	-	-	-	-	-
Task 3:1 General	Shall	Shall	Shall	Shall	Shall	-	-	-	Shall	Shall
Task 3:2 General	Shall	Shall	Shall	Shall	Shall	-	-	-	Shall	Shall
Task 3:3 Quality reception detector	Shall	Shall	Shall	Shall	Shall	-	-	-	Shall	Shall
Task 3:4 Frequencies: Center frequencies	Shall	Shall	Shall	Shall	Shall	-	-	-	Shall	Shall
Task 3:5 Frequencies: Frequency offset	Shall	Shall	Shall	Shall	Shall	-	-	-	Shall	Shall
Task 3:6 Frequencies: Signal bandwidths	Shall	Shall	Shall	Shall	Shall	-	-	-	Shall	Shall
Task 3:7 Modes	Shall	Shall	Shall	Shall	Shall	-	-	-	Shall	Shall
Task 3:8 Tuning/Scanning Procedure: General	Shall	Shall	Shall	Shall	Shall	-	-	-	Shall	Shall
Task 3:9 Tuning/Scanning Procedures: Basic status check	Shall	Shall	Shall	Shall	Shall	-	-	-	Shall	Shall
Task 3:10 Tuning/Scanning Procedures: Automatic channel search for the same service bouquet	Shall	Shall	Shall	Shall	Shall	-	-	-	Shall	Shall
Task 3:11 Tuning/Scanning: Automatic channel search for different service bouquets	Shall	Shall	Shall	Shall	Shall	-	-	-	Shall	Shall
Task 3:12 Tuning/Scanning Procedures: Manual Channel Search	Shall	Shall	Shall	Shall	Shall	-	-	-	Shall	Shall
Task 3:13 Verification of Signal Strength Indicator (SSI)	Shall	Shall	Shall	Shall	Shall	-	-	-	Shall	Shall
Task 3:14 Verification of Signal Quality Indicator (SQI)	Shall	Shall	Shall	Shall	Shall	-	-	-	Shall	Shall
Task 3:15 Changes In Modulation Parameters	Shall	Shall	Shall	Shall	Shall	-	-	-	Shall	Shall
Task 3:16 RF input connector	Shall	Shall	Shall	Shall	Shall	-	-	-	Shall	Shall
Task 3:17 RF output connector	Shall	Shall	Shall	Shall	Shall	-	-	-	Shall	Shall
Task 3:18 Performance: BER vs C/N verification	Shall	Shall	Shall	Shall	Shall	-	-	-	Shall	Shall
Task 3:19 Performance: C/N performance on Gaussian channel	Shall	Shall	Shall	Shall	Shall	-	-	-	Shall	Shall
Task 3:20 Performance: C/N performance on 0dB echo channel	Shall	Shall	Shall	Shall	Shall	-	-	-	Shall	Shall
Task 3:21 Performance: Minimum receiver signal input levels on Gaussian channel	Shall	Shall	Shall	Shall	Shall	-	-	-	Shall	Shall
Task 3:22 Performance: Minimum IRD Signal Input Levels on 0dB echo channel	Shall	Shall	Shall	Shall	Shall	-	-	-	Shall	Shall
Task 3:23 Performance: Noise figure on Gaussian channel	Shall	Shall	Shall	Shall	Shall	-	-	-	Shall	Shall
Task 3:24 Performance: Maximum Receiver Signal Input Levels	Shall	Shall	Shall	Shall	Shall	-	-	-	Shall	Shall
Task 3:25 Performance: Immunity to "digital" signals in Other Channels	Shall	Shall	Shall	Shall	Shall	-	-	-	Shall	Shall
Task 3:26 Performance: Immunity to "LTE 700 MHz" signals in Other Channels	Shall	Shall	Shall	Shall	Shall	-	-	-	Shall	Shall
Task 3:27 Performance: Immunity to "LTE 800 MHz" signals in Other Channels	Shall	Shall	Shall	Shall	Shall	-	-	-	Shall	Shall
Task 3:28 Performance: Performance in Time-Varying Channels	Shall	Shall	Shall	Shall	Shall	-	-	-	Shall	Shall
Task 3:29 Performance: Synchronisation for varying echo power levels in SFN	Shall	Shall	Shall	Shall	Shall	-	-	-	Shall	Shall









NorDig Test Task	NorDig IRD Profile									
	STB	IDTV	Basic	Hybrid	PVR	DVB-S	DVB-S2	DVB-C	DVB-T	DVB-T2
Task 15:52 Dynamic changes in video stream in playback	Shall	Shall	Shall	Shall	Shall	Shall	Shall	Shall	Shall	Shall
Task 15:53 Parental lock during playback	Shall	Shall	Shall	Shall	Shall	Shall	Shall	Shall	Shall	Shall
Task 15:54 Maintaining scheduled recordings after network update	Shall	Shall	Shall	Shall	Shall	Shall	Shall	Shall	Shall	Shall
Task 15:55 User actions disturbing the recording	Shall	Shall	Shall	Shall	Shall	Shall	Shall	Shall	Shall	Shall
<b>2.16 Task 16: IRD System Software and API</b>	-	-	-	-	-	-	-	-	-	-
Task 16:1 org.nordig_00000010 Current time, TDT/TOT available, NTP available	-	-	-	Shall	-	-	-	-	-	-
Task 16:2 org.nordig_00000020 Current time, no TDT/TOT tables, NTP available	-	-	-	Shall	-	-	-	-	-	-
Task 16:3 org.nordig_00000030 Current time, no TDT/TOT tables, no NTP, but SNTP is available	-	-	-	Shall	-	-	-	-	-	-
Task 16:4 org.nordig_00000100 parental control, blocking application	-	-	-	Shall	-	-	-	-	-	-
Task 16:5 org.nordig_00000300 EBU teletext, no HbbTV teletext	-	-	-	Shall	-	-	-	-	-	-
Task 16:6 org.nordig_00000310 HbbTV teletext, no EBU teletext	-	-	-	Shall	-	-	-	-	-	-
Task 16:7 org.nordig_00000320 EBU teletext and HbbTV teletext	-	-	-	Shall	-	-	-	-	-	-
Task 16:8 org.nordig_00000330 EBU Teletext, HbbTV teletext signalled but not available	-	-	-	Shall	-	-	-	-	-	-
Task 16:9 org.nordig_00000340 No EBU Teletext, no HbbTV teletext	-	-	-	Shall	-	-	-	-	-	-
Task 16:10 org.nordig_00000350 No EBU teletext, HbbTV teletext signalled but not available	-	-	-	Shall	-	-	-	-	-	-
Task 16:11 org.nordig_00000400 EBU subtitles over broadband TS, A/V object, no scaling	-	-	-	Shall	-	-	-	-	-	-
Task 16:12 org.nordig_00000410 EBU subtitles over broadband TS, A/V object scaled down	-	-	-	Shall	-	-	-	-	-	-
Task 16:13 org.nordig_00000420 EBU subtitles over broadband TS, A/V object scaled up	-	-	-	Shall	-	-	-	-	-	-
Task 16:14 org.nordig_00000430 DSM-CC stream events and DVB subtitles	-	-	-	Shall	-	-	-	-	-	-
Task 16:15 org.nordig_00000440 DSM-CC stream events and EBU subtitles	-	-	-	Shall	-	-	-	-	-	-
Task 16:16 org.nordig_00000500 Broadcast video scaling, 1 x 1	-	-	-	Shall	-	-	-	-	-	-
Task 16:17 org.nordig_00000510 Broadband TS video scaling, 1 x 1	-	-	-	Shall	-	-	-	-	-	-
Task 16:18 org.nordig_00000520 Broadband MP4 video scaling, 1 x 1	-	-	-	Shall	-	-	-	-	-	-
Task 16:19 org.nordig_00000600 EIT P/F, characters	-	-	-	Shall	-	-	-	-	-	-
Task 16:20 org.nordig_00000610 EIT MetadataSearch, characters	-	-	-	Shall	-	-	-	-	-	-
Task 16:21 org.nordig_00001010 Exit button on broadcast independent application: restore broadcast video	-	-	-	Shall	-	-	-	-	-	-
Task 16:22 org.nordig_00001020 Exit button: restore broadcast video from PIP mode	-	-	-	Shall	-	-	-	-	-	-
Task 16:23 org.nordig_00001050 Setting of preferredUILanguage	-	-	-	Shall	-	-	-	-	-	-
Task 16:24 org.nordig_00001060 Updating preferredUILanguage after language change in Navigator	-	-	-	Shall	-	-	-	-	-	-
Task 16:25 org.nordig_00001070 Switch subtitles: DVB to EBU teletext	-	-	-	Shall	-	-	-	-	-	-
Task 16:26 org.nordig_00001080 Switch subtitles: EBU teletext to DVB	-	-	-	Shall	-	-	-	-	-	-
Task 16:27 org.nordig_00001081 Switch subtitles over broadband TS: EBU teletext to DVB	-	-	-	Shall	-	-	-	-	-	-
Task 16:28 org.nordig_00001082 Switch subtitles over broadband TS: DVB teletext to EBU	-	-	-	Shall	-	-	-	-	-	-
Task 16:29 org.nordig_00001100 Disabling subtitles	-	-	-	Shall	-	-	-	-	-	-
Task 16:30 org.nordig_00001101 Disabling subtitles over broadband TS	-	-	-	Shall	-	-	-	-	-	-
Task 16:31 org.nordig_00001200 DVB subtitles - V/B Object not bound to current channel	-	-	-	Shall	-	-	-	-	-	-
Task 16:32 org.nordig_00001210 DVB subtitles - V/B Object bound to current channel	-	-	-	Shall	-	-	-	-	-	-
Task 16:33 org.nordig_00001220 EBU Teletext subtitles: Video/Broadcast Object not bound to current channel	-	-	-	Shall	-	-	-	-	-	-
Task 16:34 org.nordig_00001230 EBU Teletext subtitles: Video/Broadcast Object bound to current channel	-	-	-	Shall	-	-	-	-	-	-
Task 16:35 org.nordig_00001240 DVB subtitles placed behind application, V/B Object not bound to current channel	-	-	-	Shall	-	-	-	-	-	-
Task 16:36 org.nordig_00001250 DVB subtitles placed behind application, V/B Object bound to current channel	-	-	-	Shall	-	-	-	-	-	-
Task 16:37 org.nordig_00001260 EBU Teletext subtitles behind application, V/B Object not bound to current channel	-	-	-	Shall	-	-	-	-	-	-
Task 16:38 org.nordig_00001270 EBU Teletext subtitles behind application, V/B Object bound to current channel	-	-	-	Shall	-	-	-	-	-	-





## 2 Test Plan for NorDig - Test Cases

### 2.1 Task 1: Satellite tuner and demodulator

#### 2.1.1 QEF Quality Measurement Methods

If the received signal is above  $C/N$  and  $C/I$  threshold, the Forward Error Correction (FEC) technique adopted in the System is designed to provide a "Quasi Error Free" (QEF) quality target. The QEF means less than one uncorrected error-event per transmission hour, corresponding to Bit Error Ratio (BER) =  $10^{-10}$  to  $10^{-11}$  at the input of the MPEG-2 demultiplexer.

If the received signal is above the  $C/N+I$  threshold, the Forward Error Correction (FEC) technique adopted in the System is designed to provide a "Quasi Error Free" (QEF) quality target. The definition of QEF adopted for DVB-S2 is "less than one uncorrected error-event per transmission hour at the level of a 5 Mbit/s single TV service decoder", approximately corresponding to a Transport Stream Packet Error Ratio  $PER < 10^{-7}$  before demultiplexer.

In practice, it takes long time to measure such a low PER at TS data level. Therefore, the reception quality can be evaluated either indirectly by

- measuring the BER after Viterbi in DVB-S system, or BER after LDPC in DVB-S2 system
- subjectively inspecting the video screen for a certain period of time and looking for errors in the decoded video.

Direct measurements on the TS data packets are the preferred measurement method, but if this is not possible or acceptable for some reason, the indirect measurements can be used. The indirect measurement methods, which can be used, are objective BER measurements described above or subjective quality measurement.

In the indirect objective method in the DVB-S system, the BER of  $2 \cdot 10^{-4}$  after Viterbi decoder is considered to correspond to an approximation of QEF reception quality for Gaussian type of channels. But for channels interfered by impulse like interference i.e. PAL signals or internal interference, the average BER of  $2 \cdot 10^{-4}$  after Viterbi decoder is not valid due to the fact that the RS decoder is not able to correct the burst of erroneous bytes caused by impulse like interference. Therefore, for impulse like interfered channels, the quality measurements shall be done by using the BER of  $10^{-11}$  measurement method at the TS level at MPEG-2 demultiplexer input or by using the subjective measurement method.

In the indirect objective method in the DVB-S2 system the BER of  $10^{-7}$  after LDPC decoder is considered to correspond to an approximation of QEF reception quality for Gaussian type of channels.

#### Direct objective quality measurement procedure in DVB-S and DVB-S2 systems

The measurement is performed doing measurements at the transport stream data level. The measurement configuration parameters are chosen like that there is less than one uncorrected error event per hour. This requirement corresponds to BER value  $10^{-10}$ - $10^{-11}$  at the TS data level at the input of the MPEG-2 demultiplexer. In addition to the BER measurement, the reception quality shall be verified subjectively.

The performance in every test case can be evaluated by using the direct quality measurement procedure.

#### Indirect subjective quality measurement procedure 1 (QMP1) in DVB-S and DVB-S2 systems

The subjective measurement is performed during **15 seconds**. During this time the decoded video shall be error free. In a case of an error in decoded video, the change to the measurement configuration parameters shall be done. The change of the measurement configuration parameters shall result to an error free decoding of the video where the minimum time between consecutive subjective errors is **15 seconds**. Otherwise, the change of the measurement configuration parameters is repeated until an error free decoding of video is reached at least **15 seconds**.

#### Indirect objective or subjective quality measurement procedure 2 (QMP2) in DVB-S system

The measurement can be performed either by using

1. the embedded BER after Viterbi measurement provided by the receiver ,or
2. watching the decoded video for **60 seconds**.

If the BER after Viterbi measurement is chosen, the value for the approximation of the QEF reception is considered to correspond to the integrated BER after Viterbi decoder value  $2 \cdot 10^{-4}$  .The integrated BER after Viterbi measurement value  $2 \cdot 10^{-4}$  shall be verified that it corresponds an **error free video** decoding. In case of higher BER after Viterbi value than  $2 \cdot 10^{-4}$  , the change to the measurement configuration parameters shall be done. The change of the measurement configuration parameters shall result to a BER after Viterbi which is lower than or equal to  $2 \cdot 10^{-4}$  , Otherwise, the change of the measurement configuration parameters is repeated until a BER after Viterbi value lower than or equal to  $2 \cdot 10^{-4}$  is achieved.

If the **60 seconds** error free decoded video is chosen, during this time the decoded video shall be error free. In a case of an error in decoded video, the change to the measurement configuration parameters shall be done. The change of the measurement configuration parameters shall result to an error free decoding of the video where the minimum time between consecutive subjective errors is **60 seconds**. Otherwise, the change of the measurement configuration parameters is repeated until an error free decoding of video is achieved at least **60 seconds**.

Indirect objective or subjective quality measurement procedure 2 (QMP2) in DVB-S2 system

The measurement can be performed either by using

1. the embedded BER after LDPC measurement provided by the receiver, or
2. watching the decoded video for **30 seconds**.

If the BER after LDPC measurement is chosen, the value for the approximation of the QEF reception is considered to correspond to the integrated BER after LDPC decoder value  $10^{-7}$ . In case of higher BER after LDPC value than  $10^{-7}$  , the change to the measurement configuration parameters shall be done. The change of the measurement configuration parameters shall result to a BER after LDPC which is lower than or equal to  $10^{-7}$  , Otherwise, the change of the measurement configuration parameters is repeated until the BER after LDPC value lower than or equal to  $10^{-7}$  is achieved. That reception shall be verified that it corresponds an **error free video** decoding.

If the **30 seconds** error free decoded video is chosen, during this time the decoded video shall be error free. In a case of an error in decoded video, the change to the measurement configuration parameters shall be done. The change of the measurement configuration parameters shall result to an error free decoding of the video where the minimum time between consecutive subjective errors is **30 seconds**. Otherwise, the change of the measurement configuration parameters is repeated until an error free decoding of video is achieved at least **30 seconds**.

Due to the nature of the DVB-S2 system forward error correction schemes the difference for the 30 seconds error free video and BER  $10^{-7}$  after LDPC is very low. For practical testing the performance values are equal for both quality levels.

The corresponding measurement values for profile and DVB-S / DVB-S2 mode shall be achieved from tables below.

		C/N ( $E_s/N_0$ ) performance (dB)	
Modulation	Code Rate	DVB-S	DVB-S2
QPSK	1/4	n/a	-1.4
QPSK	1/3	n/a	-0.2
QPSK	2/5	n/a	0.7
QPSK	1/2	3.8	2.0
QPSK	3/5	n/a	3.2

QPSK	2/3	5.6	4.1
QPSK	3/4	6.7	5.0
QPSK	4/5	n/a	5.7
QPSK	5/6	7.7	6.2
QPSK	7/8	8.4	n/a
QPSK	8/9	n/a	7.2
QPSK	9/10	n/a	7.4
8PSK	3/5	n/a	6.5
8PSK	2/3	n/a	7.6
8PSK	3/4	n/a	8.9
8PSK	5/6	n/a	10.4
8PSK	8/9	n/a	11.7
8PSK	9/10	n/a	12.0

**Table 2.1 Maximum C/N ( $E_s/N_0$ ) for QEF reception.**

### 2.1.2 Test cases

<b>Test Case</b>	<b>Task 1:1 General</b>		
<b>Section</b>	NorDig Unified 3.1.1		
<b>Requirement</b>	The NorDig IRD shall include at least one tuner/demodulator unit for reception of signals from a satelliteRF-outdoor unit.		
<b>IRD Profile(s)</b>	Basic, IRD, DVB-S, DVB-S2		
<b>Test procedure</b>	<p><b>Purpose of test:</b> To verify that IRD contains at least one Tuner/demodulator</p> <p><b>Equipment:</b> IRD Under test</p> <p><b>Test procedure:</b> This is common requirement and will be verified in the following tests.</p>		
<b>Test result(s)</b>			
<b>Conformity</b>	<input type="checkbox"/> OK Fault <input type="checkbox"/> Major <input type="checkbox"/> Minor, define fail reason in comments		
<b>Comments</b>	If possible describe if fault can be fixed with software update: <input type="checkbox"/> YES <input type="checkbox"/> NO Describe more specific faults and/or other information		
<b>Date</b>		<b>Sign</b>	

<b>Test Case</b>	<b>Task 1:2 General</b>	
<b>Section</b>	NorDig Unified 3.1.2	
<b>Requirement</b>	The NorDig IRD shall be able to automatically scan through the whole frequency range available for each of the available Tuners/Demodulators and tune in to the correct DVB framing structure, channel coding and modulation to deliver the incoming transport stream to the next units. The tuning data shall be stored in a service list, in order to allow a quick tune in to the selected transport stream.	
<b>IRD Profile(s)</b>	Basic, IRD, DVB-S, DVB-S2	
<b>Test procedure</b>	<p><b>Purpose of test:</b> To verify that IRD is able to scan through the whole frequency range.</p> <p><b>Test procedure:</b> This is common requirement and will be verified in the following tests.</p>	
<b>Test result(s)</b>	The manufacturer describes his specific setup for the test	
<b>Conformity</b>	<input type="checkbox"/> OK Fault <input type="checkbox"/> Major <input type="checkbox"/> Minor, define fail reason in comments	
<b>Comments</b>	If possible describe if fault can be fixed with software update: <input type="checkbox"/> YES <input type="checkbox"/> NO Describe more specific faults and/or other information	
<b>Date</b>		<b>Sign</b>

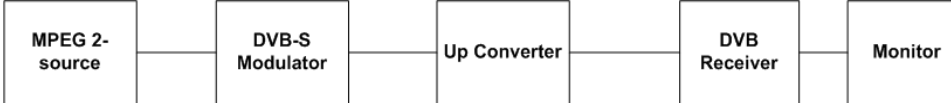
<b>Test Case</b>	<b>Task 1:3 Quality reception detector</b>	
<b>Section</b>	NorDig Unified 3.1.3	
<b>Requirement</b>	The NorDig Unified receiver shall be equipped with a reception quality detector.	
<b>IRD Profile(s)</b>	Basic, IRD, DVB-S, DVB-S2	
<b>Test procedure</b>	<p><b>Equipment:</b> Test signal are created using the test bed shown below:</p> <div style="text-align: center;">  <pre> graph LR     A[MPEG 2-source] --&gt; B[DVB-S Modulator]     B --&gt; C[Up Converter]     C --&gt; D[DVB Receiver]     D --&gt; E[Monitor]           </pre> </div> <p><b>Test procedure:</b> Check that the IRD is equipped with a reception quality detector</p> <p><b>Expected result:</b> It shall be possible to access some kind of a reception quality detector</p>	
<b>Test result(s)</b>		
<b>Conformity</b>	<input type="checkbox"/> OK Fault <input type="checkbox"/> Major <input type="checkbox"/> Minor, define fail reason in comments	
<b>Comments</b>	If possible describe if fault can be fixed with software update: <input type="checkbox"/> YES <input type="checkbox"/> NO Describe more specific faults and/or other information	
<b>Date</b>		<b>Sign</b>

<b>Test Case</b>	<b>Task 1:4 Symbol and FEC-rate (DVB-S2)</b>	
<b>Section</b>	NorDig Unified 3.2.2	
<b>Requirement</b>	The IRD accepts symbol rates between 10-30 Mbaud for DVB-S carriers.	

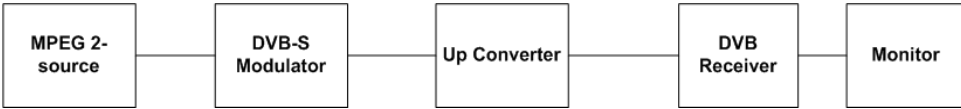
	<p>For DVB-S2 QPSK carriers the IRD accepts symbol rates between 7.5-45 Mbaud</p> <p>For DVB-S2 8PSK carriers the IRD accepts symbol rates between 5-30 Mbaud</p>																																																									
<b>IRD Profile(s)</b>	Basic, IRD, DVB-S, DVB-S2																																																									
<b>Test procedure</b>	<p><b>Purpose of test:</b> To verify that the IRD accepts a transport stream with a symbol rate in the range 10 – 30 Mbaud</p> <p><b>Equipment:</b> Test signals are created using the test bed shown below:</p> <div data-bbox="391 649 1356 757" style="text-align: center;">  <pre> graph LR     A[MPEG 2-source] --&gt; B[DVB-S Modulator]     B --&gt; C[Up Converter]     C --&gt; D[DVB Receiver]     D --&gt; E[Monitor]             </pre> </div> <p><b>Test procedure:</b></p> <ol style="list-style-type: none"> <li>1. Configure wanted signal to center frequency 1500 MHz, DVB-S QPSK, 7.5Mbaud at level -45dBm.</li> <li>2. Power on IRD.</li> <li>3. Make a channel search at wanted signal and verify that IRD locks to carrier and decodes picture without any visible degradation.</li> <li>4. Use quality measurement procedure 2 (QMP2).</li> <li>5. Repeat the test for the symbol rates and FEC modes in the measurement record.</li> </ol> <p><b>Expected result:</b> IRD locks to carrier and decodes picture without any visible degradation.</p>																																																									
<b>Test result(s)</b>	<p>Measurement record</p> <p>Result OK/NOK:</p> <table border="1" data-bbox="391 1344 1109 1601"> <thead> <tr> <th colspan="3">DVB-S QPSK carrier</th> </tr> <tr> <th>FEC rate</th> <th>Symbol rate 7.5 Mbaud</th> <th>Symbol rate 45 Mbaud</th> </tr> </thead> <tbody> <tr><td>1/2</td><td></td><td></td></tr> <tr><td>2/3</td><td></td><td></td></tr> <tr><td>3/4</td><td></td><td></td></tr> <tr><td>5/6</td><td></td><td></td></tr> <tr><td>7/8</td><td></td><td></td></tr> </tbody> </table> <table border="1" data-bbox="391 1624 1109 2038"> <thead> <tr> <th colspan="3">DVB-S2 QPSK carrier</th> </tr> <tr> <th>FEC rate</th> <th>Symbol rate 7.5 Mbaud</th> <th>Symbol rate 45 Mbaud</th> </tr> </thead> <tbody> <tr><td>1/4</td><td></td><td></td></tr> <tr><td>1/3</td><td></td><td></td></tr> <tr><td>2/5</td><td></td><td></td></tr> <tr><td>1/2</td><td></td><td></td></tr> <tr><td>3/5</td><td></td><td></td></tr> <tr><td>2/3</td><td></td><td></td></tr> <tr><td>3/4</td><td></td><td></td></tr> <tr><td>4/5</td><td></td><td></td></tr> <tr><td>5/6</td><td></td><td></td></tr> <tr><td>8/9</td><td></td><td></td></tr> </tbody> </table>	DVB-S QPSK carrier			FEC rate	Symbol rate 7.5 Mbaud	Symbol rate 45 Mbaud	1/2			2/3			3/4			5/6			7/8			DVB-S2 QPSK carrier			FEC rate	Symbol rate 7.5 Mbaud	Symbol rate 45 Mbaud	1/4			1/3			2/5			1/2			3/5			2/3			3/4			4/5			5/6			8/9		
DVB-S QPSK carrier																																																										
FEC rate	Symbol rate 7.5 Mbaud	Symbol rate 45 Mbaud																																																								
1/2																																																										
2/3																																																										
3/4																																																										
5/6																																																										
7/8																																																										
DVB-S2 QPSK carrier																																																										
FEC rate	Symbol rate 7.5 Mbaud	Symbol rate 45 Mbaud																																																								
1/4																																																										
1/3																																																										
2/5																																																										
1/2																																																										
3/5																																																										
2/3																																																										
3/4																																																										
4/5																																																										
5/6																																																										
8/9																																																										



	9/10		
	DVB-S2 8PSK carrier		
	FEC rate	Symbol rate 5 Mbaud	Symbol rate 30 Mbaud
	3/5		
	2/3		
	3/4		
	5/6		
	8/9		
	9/10		
	<b>Conformity</b>	<input type="checkbox"/> <b>OK Fault</b> <input type="checkbox"/> Major <input type="checkbox"/> Minor, define fail reason in comments	
<b>Comments</b>	If possible describe if fault can be fixed with software update: <input type="checkbox"/> <b>YES</b> <input type="checkbox"/> <b>NO</b> Describe more specific faults and/or other information		
<b>Date</b>		<b>Sign</b>	

<b>Test Case</b>	<b>Task 1:5 Input Frequency Range/Tuning range</b>
<b>Section</b>	NorDig Unified 3.2.3
<b>Requirement</b>	IRD locks to carrier and decodes picture without any visible degradation.
<b>IRD Profile(s)</b>	Basic, IRD, DVB-S, DVB-S2
<b>Test procedure</b>	<p><b>Purpose of test:</b> To verify that IRD accepts an input signal in the range 950 – 2150 MHz</p> <p><b>Equipment:</b> Test signals are created using the test bed shown below:</p> <div style="text-align: center;"> <pre> graph LR     A[MPEG 2-source] --- B[DVB-S Modulator]     B --- C[Up Converter]     C --- D[DVB Receiver]     D --- E[Monitor]           </pre> </div> <p><b>Test procedure:</b></p> <ol style="list-style-type: none"> <li>1. Configure wanted signal to center frequency 10715 MHz, DVB-S QPSK, FEC=7/8, 30Mbaud at level -45dBm.</li> <li>2. Power on IRD.</li> <li>3. Configure Universal LNBF in the IRD settings (f(LO)=9750/10600).</li> <li>4. Make a channel search at wanted signal and verify that IRD locks to carrier and decodes picture without any visible degradation.</li> <li>5. Use quality measurement procedure 2 (QMP2).</li> </ol> <p>Repeat the test for the centre frequencies in the measurement record.</p> <p><b>Expected result:</b> IRD locks to carrier and decodes picture without any visible degradation.</p>



<b>Test result(s)</b>	Measurement record:				
	IF frequency [MHz]	LO frequency [MHz]	Centre frequency [MHz]	Polarisation (H/V)	Result OK/NOK
	965	9750	10715	H	
	965	9750	10715	V	
	1949	9750	11699	H	
	1949	9750	11699	V	
	1100	10600	11700	H	
	1100	10600	11700	V	
	2135	10600	12735	H	
2135	10600	12735	V		
<b>Conformity</b>	<input type="checkbox"/> <b>OK Fault</b> <input type="checkbox"/> Major <input type="checkbox"/> Minor, define fail reason in comments				
<b>Comments</b>	If possible describe if fault can be fixed with software update: <input type="checkbox"/> <b>YES</b> <input type="checkbox"/> <b>NO</b> Describe more specific faults and/or other information				
<b>Date</b>		<b>Sign</b>			

<b>Test Case</b>	<b>Task 1:6 Tuning/ Scanning Procedures (with NIT)</b>				
<b>Section</b>	NorDig Unified 3.2.6				
<b>Requirement</b>	The NorDig IRD shall either use the NIT information or the scanning procedure for retrieving the services available on the network.				
<b>IRD Profile(s)</b>	Basic, IRD, DVB-S, DVB-S2				
<b>Test procedure</b>	<p><b>Purpose of test:</b> To verify that the IRD use tuning data given in NIT.</p> <p><b>Equipment:</b> IRD under test, with service list deleted and using the test bed shown below:</p> <div style="text-align: center;"> <pre> graph LR     A[MPEG 2-source] --- B[DVB-S Modulator]     B --- C[Up Converter]     C --- D[DVB Receiver]     D --- E[Monitor]           </pre> </div> <p><b>Test procedure:</b> Start automatic tuning and installation of services, using Network Information Tables (NIT), and check found and installed channels.</p> <p><b>Expected result:</b> All signalled channels are found and installed.</p>				
<b>Test result(s)</b>					
<b>Conformity</b>	<input type="checkbox"/> <b>OK Fault</b> <input type="checkbox"/> Major <input type="checkbox"/> Minor, define fail reason in comments				
<b>Comments</b>	If possible describe if fault can be fixed with software update: <input type="checkbox"/> <b>YES</b> <input type="checkbox"/> <b>NO</b> Describe more specific faults and/or other information				
<b>Date</b>		<b>Sign</b>			

<b>Test Case</b>	<b>Task 1:7 Tuning/ Scanning Procedures (without NIT)</b>				
------------------	-----------------------------------------------------------	--	--	--	--

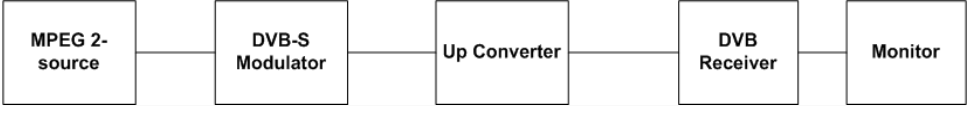

<b>Section</b>	NorDig Unified 3.2.6
<b>Requirement</b>	The NorDig IRD shall either use the NIT information or the scanning procedure for retrieving the services available on the network.
<b>IRD Profile(s)</b>	Basic, IRD, DVB-S, DVB-S2
<b>Test procedure</b>	<p><b>Purpose of test:</b> To verify that the IRD searches for - and installs services - without 'a priori' NIT information.</p> <p><b>Equipment:</b> IRD under test, with service list deleted and using the test bed shown below:</p>  <pre> graph LR     A[MPEG 2-source] --- B[DVB-S Modulator]     B --- C[Up Converter]     C --- D[DVB Receiver]     D --- E[Monitor]           </pre> <p><b>Test procedure:</b> Start automatic tuning and installation of services, without Network Information Tables (NIT), and check found and installed channels.</p> <p><b>Expected result:</b> All signalled channels are found and installed.</p>
<b>Test result(s)</b>	
<b>Conformity</b>	<input type="checkbox"/> OK Fault <input type="checkbox"/> Major <input type="checkbox"/> Minor, define fail reason in comments
<b>Comments</b>	If possible describe if fault can be fixed with software update: <input type="checkbox"/> YES <input type="checkbox"/> NO Describe more specific faults and/or other information
<b>Date</b>	<b>Sign</b>

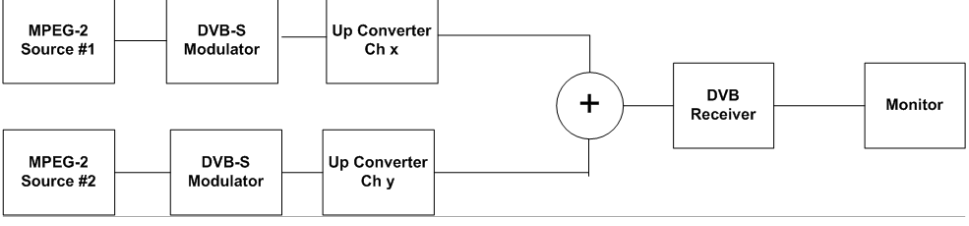
<b>Test Case</b>	<b>Task 1:8 Control signals</b>
<b>Section</b>	NorDig Unified 3.2.5
<b>Requirement</b>	The Tuner/Demodulator shall be able to select between at least two RF units, upper and lower band as well as polarisation within each unit in accordance with EN 61319-1 [13], level 1 (the "DiSEqC" specification, level 1.0).
<b>IRD Profile(s)</b>	Basic, IRD, DVB-S, DVB-S2
<b>Test procedure</b>	<p><b>Purpose of test:</b> To verify that the IRD is able to select between two RF-units.</p> <p><b>Equipment:</b> DTH antenna with dual-feed Universal LNBS, pointed at i.e. '1 degree W' and '5 degree E' or test signals are created using the test bed shown below:</p>  <pre> graph LR     A[MPEG-2 Source #1] --- B[DVB-S Modulator]     B --- C[Up Converter Ch x]     D[MPEG-2 Source #2] --- E[DVB-S Modulator]     E --- F[Up Converter Ch y]     C --- G((+))     F --- G     G --- H[DVB Receiver]     H --- I[Monitor]           </pre> <p>A DiSEqC-switch is used to select between the LNBS.</p> <p><b>Test procedure:</b> Check that tuning to carriers in both '1 degree W' and '5 degree E' (or test bed signals) is possible by DiSEqC command.</p>

	<b>Expected result:</b> All signalled channels are installed and IRD decodes picture and sound without any visible degradation.	
<b>Test result(s)</b>		
<b>Conformity</b>	<input type="checkbox"/> OK Fault <input type="checkbox"/> Major <input type="checkbox"/> Minor, define fail reason in comments	
<b>Comments</b>	If possible describe if fault can be fixed with software update: <input type="checkbox"/> YES <input type="checkbox"/> NO Describe more specific faults and/or other information	
<b>Date</b>		<b>Sign</b>

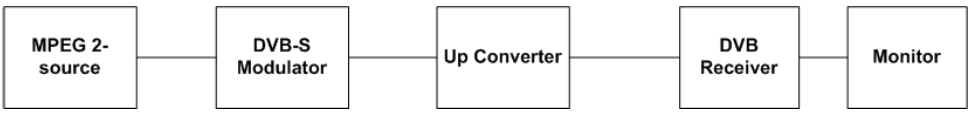
<b>Test Case</b>	<b>Task 1:9 Demodulation (DVB-S2)</b>								
<b>Section</b>	NorDig Unified 3.2.4								
<b>Requirement</b>	Demodulation, descrambling and error correction shall be performed for all symbol rates given above and for all error correction rates and filter roll-off rates as specified for DVB-S, see EN 300 421 [14] and for DVB-S2, see ETSI EN 302 307 [23] and the satellite_delivery_system_descriptor, see Table 13.1.								
<b>IRD Profile(s)</b>	Basic, IRD, DVB-S2								
<b>Test procedure</b>	<p><b>Purpose of test:</b> To verify the basic performance of the IRD.</p> <p><b>Equipment:</b> Test signals are created using the test bed shown below:</p> <div style="text-align: center;">  <pre> graph LR     A[MPEG 2-source] --&gt; B[DVB-S Modulator]     B --&gt; C[Up Converter]     C --&gt; D[DVB Receiver]     D --&gt; E[Monitor]             </pre> </div> <p><b>Test procedure:</b></p> <ol style="list-style-type: none"> <li>1. Configure wanted signal to center frequency 1500 MHz, DVB-S QPSK, FEC=1/2, 10Mbaud at level -60dBm.</li> <li>2. Power on IRD.</li> <li>3. Make a channel search at wanted signal and verify that IRD locks to carrier and decodes picture without any visible degradation.</li> <li>4. Increase the C/N from low value to higher value until the QMP2 criteria fulfills.</li> <li>5. Fill in the C/N value to the measurement record table.</li> <li>6. Repeat the test for all modulation, FEC and symbol rate combinations in the measurement record tables.</li> </ol> <p>Note: C/N measured for a bandwidth that equals the symbol rate (<math>E_s/N_0=C/N</math>).</p> <p><b>Expected result:</b> IRD decodes picture and sound without any visible degradation. IRD Es/No performance meets the requirements.</p>								
<b>Test result(s)</b>	<p>Measurement record:</p> <p>DVB-S QPSK, Roll-off=0.35:</p> <table border="1" style="width: 100%; border-collapse: collapse;"> <tr> <td style="width: 15%;">FEC</td> <td style="width: 15%;">P<sub>in</sub>=-60dBm SR=10Mbaud Measured C/N</td> <td style="width: 15%;">P<sub>in</sub>=-25dBm SR=10Mbaud Measured C/N</td> <td style="width: 15%;">P<sub>in</sub>=-60dBm SR=30Mbaud Measured C/N</td> <td style="width: 15%;">P<sub>in</sub>=-25dBm SR=30Mbaud Measured C/N</td> </tr> </table>				FEC	P <sub>in</sub> =-60dBm SR=10Mbaud Measured C/N	P <sub>in</sub> =-25dBm SR=10Mbaud Measured C/N	P <sub>in</sub> =-60dBm SR=30Mbaud Measured C/N	P <sub>in</sub> =-25dBm SR=30Mbaud Measured C/N
FEC	P <sub>in</sub> =-60dBm SR=10Mbaud Measured C/N	P <sub>in</sub> =-25dBm SR=10Mbaud Measured C/N	P <sub>in</sub> =-60dBm SR=30Mbaud Measured C/N	P <sub>in</sub> =-25dBm SR=30Mbaud Measured C/N					

1/2				
2/3				
3/4				
5/6				
7/8				

DVB-S2 QPSK, Roll-off=0.25, Pilots=Enabled, FECframe=64800

FEC	P <sub>in</sub> =-60dBm SR=10Mbaud Measured C/N	P <sub>in</sub> =-25dBm SR=10Mbaud Measured C/N	P <sub>in</sub> =-60dBm SR=30Mbaud Measured C/N	P <sub>in</sub> =-25dBm SR=30Mbaud Measured C/N
1/4				
1/3				
2/5				
1/2				
3/5				
2/3				
3/4				
4/5				
5/6				
8/9				
9/10				

DVB-S2 QPSK, Roll-off=0.25, Pilots=Disabled, FECframe=64800

FEC	P <sub>in</sub> =-60dBm SR=10Mbaud Measured C/N	P <sub>in</sub> =-25dBm SR=10Mbaud Measured C/N	P <sub>in</sub> =-60dBm SR=30Mbaud Measured C/N	P <sub>in</sub> =-25dBm SR=30Mbaud Measured C/N
1/4				
1/3				
2/5				
1/2				
3/5				
2/3				
3/4				
4/5				
5/6				
8/9				
9/10				

DVB-S2 8PSK, Roll-off=0.25, Pilots=Enabled, FECframe=64800

FEC	P <sub>in</sub> =-60dBm SR=10Mbaud Measured C/N	P <sub>in</sub> =-25dBm SR=10Mbaud Measured C/N	P <sub>in</sub> =-60dBm SR=30Mbaud Measured C/N	P <sub>in</sub> =-25dBm SR=30Mbaud Measured C/N
3/5				
2/3				
3/4				
5/6				
8/9				
9/10				

DVB-S2 8PSK, Roll-off=0.25, Pilots=Disabled, FECframe=64800

FEC	P <sub>in</sub> =-60dBm SR=10Mbaud Measured C/N	P <sub>in</sub> =-25dBm SR=10Mbaud Measured C/N	P <sub>in</sub> =-60dBm SR=30Mbaud Measured C/N	P <sub>in</sub> =-25dBm SR=30Mbaud Measured C/N
3/5				
2/3				
3/4				



	5/6				
	8/9				
	9/10				
<b>Conformity</b>	<input type="checkbox"/> OK Fault <input type="checkbox"/> Major <input type="checkbox"/> Minor, define fail reason in comments				
<b>Comments</b>	If possible describe if fault can be fixed with software update: <input type="checkbox"/> YES <input type="checkbox"/> NO Describe more specific faults and/or other information				
<b>Date</b>		<b>Sign</b>			

<b>Test Case</b>	<b>Task 1:10 RF Input Connector and Output Connector (option)</b>				
<b>Section</b>	NorDig Unified 3.2.7.1				
<b>Requirement</b>	The NorDig IRD shall include one input connector, type: IEC 61169-24, F-type, female, 75 ohms. The NorDig IRD should include one output connector, type: IEC 61169-24, F-type, female, 75 ohms. The RF output shall be available independently from the operational status of the IRD (operational or stand by), so that there is no restriction for the operation of the connected equipment. The control of the RF unit has to be solved for the case with one or more additional IRDs.				
<b>IRD Profile(s)</b>	Basic, IRD, DVB-S, DVB-S2				
<b>Test procedure</b>	<p><b>Purpose of test:</b> To verify that the receiver has a correct input connector for the reception of the DVB-S signals.</p> <p><b>Equipment:</b> IRD under test.</p> <p><b>Test procedure:</b></p> <ol style="list-style-type: none"> <li>Verify that the RF input and output connectors are accordance the specification IEC 61169-24, F-type, female.</li> <li>Verify in the manufacturer's technical specification that the input impedance of the RF input is 75 ohm and the return loss is typically 10dB, worst case 8dB.</li> </ol> <p><b>Expected result:</b> RF input connector is as defined in specification IEC 61169-24 and the input impedance is 75ohm.</p>				
<b>Test result(s)</b>					
<b>Conformity</b>	<input type="checkbox"/> OK Fault <input type="checkbox"/> Major <input type="checkbox"/> Minor, define fail reason in comments				
<b>Comments</b>	If possible describe if fault can be fixed with software update: <input type="checkbox"/> YES <input type="checkbox"/> NO Describe more specific faults and/or other information				
<b>Date</b>		<b>Sign</b>			

<b>Test Case</b>	<b>Task 1:11 Input Signal Level</b>				
<b>Section</b>	NorDig Unified 3.2.7.2				
<b>Requirement</b>	The NorDig IRD shall accept input signals with a level in the range -25 to -60 dBm.				
<b>IRD Profile(s)</b>	Basic, IRD, DVB-S, DVB-S2				

**Test procedure**

**Purpose of test:**

To verify that the receiver can receive input signals with a level in the range -25 to -60 dBm.

**Equipment:**

Test signals are created using the test bed shown below:

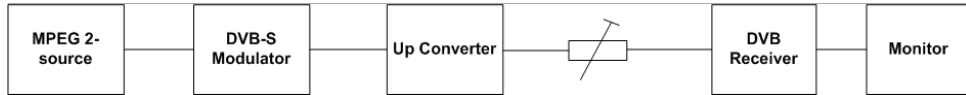

**Test procedure:**

1. Configure wanted signal to IF frequency 965 MHz, DVB-S QPSK, FEC=7/8, 30Mbaud at level -60dBm.
2. Power on IRD.
3. Make a channel search at wanted signal.
4. Verify that IRD locks to carrier and decodes picture without any visible degradation (meets QMP2).
5. Increase the wanted signal level to -25dBm.
6. Verify that IRD locks to carrier and decodes picture without any visible degradation (meets QMP2).

Repeat the test for the centre frequencies and modes in the measurement record.

**Expected result:**

IRD decodes picture and sound without any visible degradation.

**Test result(s)**

Measurement record:

DVB-S QPSK FEC=7/8 SR=30Msym/s

IF frequency [MHz]	Min signal level [dBm]	Max signal level [dBm]
965		
2135		

DVB-S2 QPSK FEC=9/10 SR=30Msym/s, Roll-off: 0.25, Pilots On

IF frequency [MHz]	Min signal level [dBm]	Max signal level [dBm]
965		
2135		

DVB-S2 QPSK FEC=9/10 SR=30Msym/s, Roll-off: 0.25, Pilots Off

IF frequency [MHz]	Min signal level [dBm]	Max signal level [dBm]
965		
2135		

DVB-S 8PSK FEC=9/10 SR=30Msym/s, Roll-off: 0.25, Pilots On

IF frequency [MHz]	Min signal level [dBm]	Max signal level [dBm]
965		
2135		

	DVB-S 8PSK FEC=9/10 SR=30Msym/s, Roll-off: 0.25, Pilots Off		
	IF frequency [MHz]	Min signal level [dBm]	Max signal level [dBm]
	965		
	2135		
<b>Conformity</b>	<input type="checkbox"/> <b>OK Fault</b> <input type="checkbox"/> Major <input type="checkbox"/> Minor, define fail reason in comments		
<b>Comments</b>	If possible describe if fault can be fixed with software update: <input type="checkbox"/> <b>YES</b> <input type="checkbox"/> <b>NO</b> Describe more specific faults and/or other information		
<b>Date</b>		<b>Sign</b>	

<b>Test Case</b>	<b>Task 1:12 Power Supply and Control Signal (to RF unit)</b>
<b>Section</b>	NorDig Unified 3.2.7.3
<b>Requirement</b>	The NorDig IRD shall provide power supply and control signals to the external RF-unit as specified below: <ul style="list-style-type: none"> <li>• voltage: 13.5/18.5 V +/- 5%</li> <li>• current: at least 400 mA</li> <li>• control tone: amplitude: 0.65 V +/- 0.25V frequency: 22 kHz duty cycle: 50% +/- 10% (see also ref EN 61319-1 (DiSEqC)).</li> </ul>
<b>IRD Profile(s)</b>	Basic, IRD, DVB-S, DVB-S2

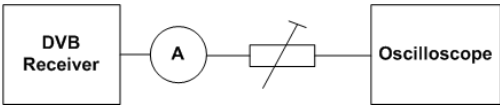
<b>Test procedure</b>	<p><b>Purpose of test:</b> To verify that power supply and control signals to the external RF-unit are as specified.</p> <p><b>Equipment:</b></p>  <p><b>Test procedure:</b> Measure voltage, current and control tone from external RF unit connector.</p> <ol style="list-style-type: none"> <li>1. Configure the IRD to the lower Ku band frequency, e.g. transmission parameters DVB-S QPSK <math>f=10750\text{MHz}</math>, <math>\text{FEC}=7/8</math>, horizontal polarization, using LNB <math>f(\text{LO})=9750/10600\text{MHz}</math></li> <li>2. Measure the following characteristics at the receiver RF input             <ol style="list-style-type: none"> <li>a. LNB supply DC voltage</li> <li>b. DC current</li> <li>c. Control tone frequency</li> <li>d. Control tone peak-to-peak voltage</li> <li>e. Control tone duty cycle</li> <li>f. Control tone rise and fall times</li> </ol> </li> <li>3. Fill in the measurement record</li> <li>4. Repeat the test for other parameter combinations in the measurement record.</li> </ol> <p><b>Expected result:</b> The IRD provides power supply and control signals to the external RF-unit as specified.</p>																																													
<b>Test result(s)</b>	<p>Measurement record:</p> <table border="1" style="width: 100%; border-collapse: collapse;"> <thead> <tr> <th>f(RF) [MHz]</th> <th>Polarisation (H/V)</th> <th>LNB supply voltage <math>V_{\text{DC}}</math></th> <th><math>I_{\text{DC}}</math></th> <th><math>f_{\text{CTRL}}</math></th> <th><math>V_{\text{PP,CTR}}</math> L</th> <th><math>D_{\text{CTRL}}</math></th> <th><math>t_{\text{r}}</math></th> <th><math>t_{\text{f}}</math></th> </tr> </thead> <tbody> <tr> <td>10750</td> <td>H</td> <td></td> <td></td> <td></td> <td></td> <td></td> <td></td> <td></td> </tr> <tr> <td>10750</td> <td>V</td> <td></td> <td></td> <td></td> <td></td> <td></td> <td></td> <td></td> </tr> <tr> <td>12600</td> <td>H</td> <td></td> <td></td> <td></td> <td></td> <td></td> <td></td> <td></td> </tr> <tr> <td>12600</td> <td>V</td> <td></td> <td></td> <td></td> <td></td> <td></td> <td></td> <td></td> </tr> </tbody> </table>	f(RF) [MHz]	Polarisation (H/V)	LNB supply voltage $V_{\text{DC}}$	$I_{\text{DC}}$	$f_{\text{CTRL}}$	$V_{\text{PP,CTR}}$ L	$D_{\text{CTRL}}$	$t_{\text{r}}$	$t_{\text{f}}$	10750	H								10750	V								12600	H								12600	V							
f(RF) [MHz]	Polarisation (H/V)	LNB supply voltage $V_{\text{DC}}$	$I_{\text{DC}}$	$f_{\text{CTRL}}$	$V_{\text{PP,CTR}}$ L	$D_{\text{CTRL}}$	$t_{\text{r}}$	$t_{\text{f}}$																																						
10750	H																																													
10750	V																																													
12600	H																																													
12600	V																																													
<b>Conformity</b>	<input type="checkbox"/> <b>OK Fault</b> <input type="checkbox"/> Major <input type="checkbox"/> Minor, define fail reason in comments																																													
<b>Comments</b>	<p>If possible describe if fault can be fixed with software update: <input type="checkbox"/> <b>YES</b> <input type="checkbox"/> <b>NO</b></p> <p>Describe more specific faults and/or other information</p>																																													
<b>Date</b>	<b>Sign</b>																																													

<b>Test Case</b>	<b>Task 1:13 Power Supply and Control Signal (to single-channel RF unit)</b>
<b>Section</b>	NorDig Unified 3.2.5, NorDig Unified 3.2.7.3
<b>Requirement</b>	The Tuner/Demodulator shall be able to select transport stream in accordance with EN 50494 Satellite [10] ("Signal distribution over a single coaxial cable in single dwelling installations
<b>IRD Profile(s)</b>	Basic, IRD, DVB-S, DVB-S2

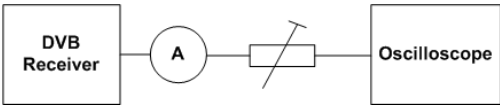
<b>Test procedure</b>	<p><b>Purpose of test:</b> To verify that power supply and control signals to the external RF-unit are as specified.</p> <p><b>Equipment:</b></p>  <p><b>Test procedure:</b> TBD</p> <p><b>Expected result:</b> TBD</p>
<b>Test result(s)</b>	
<b>Conformity</b>	<input type="checkbox"/> OK Fault <input type="checkbox"/> Major <input type="checkbox"/> Minor, define fail reason in comments
<b>Comments</b>	If possible describe if fault can be fixed with software update: <input type="checkbox"/> YES <input type="checkbox"/> NO Describe more specific faults and/or other information
<b>Date</b>	<b>Sign</b>

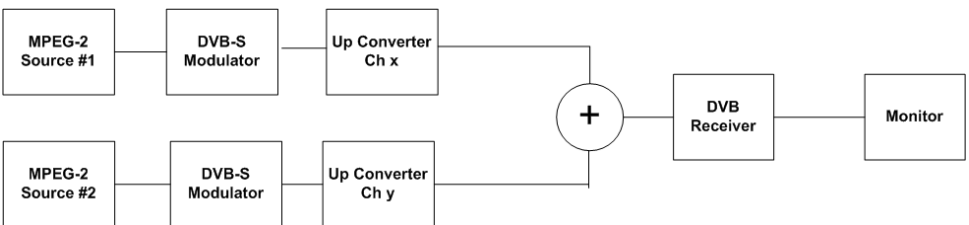
<b>Test Case</b>	<b>Task 1:14 Performance: Digital interference</b>
<b>Section</b>	NorDig Unified 3.2.8
<b>Requirement</b>	IRD decodes picture and sound without any visible degradation.
<b>IRD Profile(s)</b>	Basic, IRD, DVB-S, DVB-S2
<b>Test procedure</b>	<p><b>Purpose of test:</b> To verify the performance of the IRD in a multi-carrier environment.</p> <p><b>Equipment:</b> Test signals are created using the test bed shown below:</p>  <p><b>Test procedure:</b> UACI/LACI: Symbol rate and power equal to wanted carrier. Frequency separation from wanted carrier: +/- 1.25 SR.</p> <p>Verify that IRD can receive input signals with a level in the range -25 to -60 dBm</p> <ol style="list-style-type: none"> <li>1. Configure wanted signal to IF frequency 1500 MHz, DVB-S QPSK, FEC=7/8, 10Mbaud at level -60dBm and interferer signal on <math>f(IF)+1.25SR = 1512,5</math> MHz with power level and transmission parameters equal to the wanted signal.</li> <li>2. Power on IRD.</li> <li>3. Make a channel search at wanted signal and verify that IRD locks to carrier and decodes picture without any visible degradation.</li> <li>4. Apply Gaussian noise over the wanted signal so that reception is not possible.</li> </ol>



5. Increase the C/N from low value to higher value until the reception quality meets QMP2.
6. Fill in the result in the measurement record.

Repeat the test for the centre frequencies and modes in the measurement record.

**Expected result:**

IRD decodes picture and sound without any visible degradation. The minimum Es/No meets the requirement in NorDig Unified specification [1] with 0.5dB allowance.

**Test result(s)**

Measurement record

DVB-S QPSK FEC=7/8, Roll-off=0.35, Channel spacing = 1.25xSR

Symbol Rate [Mbaud]	IF frequency interferer [MHz]	IF frequency wanted [MHz]	Es/No (C/N) level [dB]
10	1512,5	1500	
10	1487,5	1475	
30	1537,5	1501.5	
30	1462,5	1426.5	

DVB-S2 QPSK FEC=9/10, Roll-off=0.25, Channel spacing = 1.20xSR, Pilots ON

Symbol Rate [Mbaud]	IF frequency interferer [MHz]	IF frequency wanted [MHz]	Es/No (C/N) level [dB]
10	1512	1500	
10	1488	1476	
30	1536	1500	
30	1464	1428	

DVB-S2 QPSK FEC=9/10, Roll-off=0.25, Channel spacing = 1.20xSR, Pilots OFF

Symbol Rate [Mbaud]	IF frequency interferer [MHz]	IF frequency wanted [MHz]	Es/No (C/N) level [dB]
10	1512	1500	
10	1488	1476	
30	1536	1500	
30	1464	1428	

DVB-S2 8PSK FEC=9/10, Roll-off=0.25, Channel spacing = 1.20xSR, Pilots ON

Symbol Rate [Mbaud]	IF frequency interferer [MHz]	IF frequency wanted [MHz]	Es/No (C/N) level [dB]
10	1512	1500	
10	1488	1476	
30	1536	1500	
30	1464	1428	

DVB-S2 8PSK FEC=9/10, Roll-off=0.25, Channel spacing = 1.20xSR, Pilots OFF

Symbol Rate [Mbaud]	IF frequency interferer [MHz]	IF frequency wanted [MHz]	Es/No (C/N) level [dB]
10	1512	1500	
10	1488	1476	
30	1536	1500	
30	1464	1428	



NorDig

<i>Conformity</i>	<input type="checkbox"/> <b>OK Fault</b> <input type="checkbox"/> Major <input type="checkbox"/> Minor, define fail reason in comments
<i>Comments</i>	If possible describe if fault can be fixed with software update: <input type="checkbox"/> <b>YES</b> <input type="checkbox"/> <b>NO</b> Describe more specific faults and/or other information
<i>Date</i>	<i>Sign</i>

## 2.2 Task 2: Cable Tuner and Demodulator

### 2.2.1 QEF Quality Measurement Methods

The quality limit in this specification is defined as Quasi Error Free (QEF) reception, where QEF means less than one uncorrected error event per hour. The definition of QEF corresponds to BER of  $10^{-11}$  in the TS data at input of the MPEG-2 demultiplexer. In practice, it takes long time to measure such a low BER at TS data level. Therefore, the reception quality can be evaluated either indirectly by

- measuring the BER after Viterbi in DVB-C system, or
- subjectively inspecting the video screen for a certain period of time and looking for errors in the decoded video.

Direct measurements on the TS data packets are the preferred measurement method, but if this is not possible or acceptable for some reason, the indirect measurements can be used. The indirect measurement methods, which can be used, are objective BER measurements described above or subjective quality measurement.

In the indirect objective method in the DVB-C system, the BER of  $2 \cdot 10^{-4}$  after Viterbi decoder is considered to correspond to an approximation of QEF reception quality for Gaussian type of channels. But for channels interfered by impulse like interference i.e. PAL signals or internal interference, the average BER of  $2 \cdot 10^{-4}$  after Viterbi decoder is not valid due to the fact that the RS decoder is not able to correct the burst of erroneous bytes caused by impulse like interference. Therefore, for impulse like interfered channels, the quality measurements shall be done by using the BER of  $10^{-11}$  measurement method at the TS level at MPEG-2 demultiplexer input or by using the subjective measurement method.

In the indirect subjective measurement method the certain period of time of error free video decoding is considered to corresponds to a good reception quality. The specified video test sequence can be any containing movement everywhere, in order to minimise the number of errors not being observed due to error concealment techniques in the receiver. Such a relevant video sequences are e.g. 'Mobile and calendar' and 'Zoneplate'.

The result of the indirect quality measurements may differ. Therefore, the method that shall be used is specified in every test case. However, the reception quality shall be verified by using the subjective measurement method for every test case. The measurement methods (procedures) are defined below.

#### Direct objective quality measurement procedure in DVB-C systems

The measurement is performed doing measurements at the transport stream data level. The measurement configuration parameters are chosen like that there is less than one uncorrected error event per hour. This requirement corresponds to BER value  $10^{-11}$  at the TS data level at the input of the MPEG-2 demultiplexer. In addition to the BER measurement, the reception quality shall be verified subjectively.

The performance in every test case can be evaluated by using the direct quality measurement procedure.

#### Indirect subjective quality measurement procedure 1 (OMP1) in DVB-C systems

The subjective measurement is performed during **15 seconds**. During this time the decoded video shall be error free. In a case of an error in decoded video, the change to the measurement configuration parameters shall be done. The change of the measurement configuration parameters shall result to an error free decoding of the video where the minimum time between consecutive subjective errors is **15 seconds**. Otherwise, the change of the measurement configuration parameters is repeated until an error free decoding of video is reached at least **15 seconds**.

Indirect objective or subjective quality measurement procedure 2 (QMP2) in DVB-C system

The measurement can be performed either by using

3. the embedded BER after Viterbi measurement provided by the receiver ,or
4. watching the decoded video for **60 seconds**.

If the BER after Viterbi measurement is chosen, the value for the approximation of the QEF reception is considered to correspond to the integrated BER after Viterbi decoder value  $2 \cdot 10^{-4}$  .The integrated BER after Viterbi measurement value  $2 \cdot 10^{-4}$  shall be verified that it corresponds an **error free video** decoding. In case of higher BER after Viterbi value than  $2 \cdot 10^{-4}$  , the change to the measurement configuration parameters shall be done. The change of the measurement configuration parameters shall result to a BER after Viterbi which is lower than or equal to  $2 \cdot 10^{-4}$  , Otherwise, the change of the measurement configuration parameters is repeated until a BER after Viterbi value lower than or equal to  $2 \cdot 10^{-4}$  is achieved.

If the **60 seconds** error free decoded video is chosen, during this time the decoded video shall be error free. In a case of an error in decoded video, the change to the measurement configuration parameters shall be done. The change of the measurement configuration parameters shall result to an error free decoding of the video where the minimum time between consecutive subjective errors is **60 seconds**. Otherwise, the change of the measurement configuration parameters is repeated until an error free decoding of video is achieved at least **60 seconds**.

**2.2.2 Test cases**

<i>Test Case</i>	<b>Task 2:1 General</b>	
<i>Section</i>	NorDig Unified 3.1.1	
<i>Requirement</i>	The NorDig IRD shall contain at least one Tuner/Demodulator for cable DVB/MPEG 2 signals.	
<i>IRD profile(s)</i>	Basic, IRD, DVB-C	
<i>Test procedure</i>	<p><b>Purpose of test:</b> To verify that IRD contains at least one Tuner/demodulator</p> <p><b>Equipment:</b> IRD Under test.</p> <p><b>Test procedure:</b> This is common requirement and will be verified in the following tests.</p>	
<i>Test result(s)</i>		
<i>Conformity</i>	<input type="checkbox"/> OK Fault <input type="checkbox"/> Major <input type="checkbox"/> Minor, define fail reason in comments	
<i>Comments</i>	If possible describe if fault can be fixed with software update: <input type="checkbox"/> YES <input type="checkbox"/> NO Describe more specific faults and/or other information	
<i>Date</i>		<i>Sign</i>

<i>Test Case</i>	<b>Task 2:2 General</b>	
<i>Section</i>	NorDig Unified 3.1.2	
<i>Requirement</i>	The NorDig IRD shall be able to automatically scan through the whole frequency range available for each of the available Tuners/Demodulators and tune in to the correct DVB framing structure, channel coding and modulation to deliver the incoming transport stream to the next units. The tuning data shall be stored in a service list, in order to allow a quick tune in to the selected transport stream. For more detail see below.	



<b>IRD profile(s)</b>	Basic, IRD, DVB-C	
<b>Test procedure</b>	<p><b>Purpose of test:</b> To verify that IRD is able to scan through the whole frequency range.</p> <p><b>Test procedure:</b> This is common requirement and will be verified in the following tests.</p>	
<b>Test result(s)</b>	The manufacturer describes his specific setup for the test	
<b>Conformity</b>	<input type="checkbox"/> <b>OK Fault</b> <input type="checkbox"/> Major <input type="checkbox"/> Minor, define fail reason in comments	
<b>Comments</b>	If possible describe if fault can be fixed with software update: <input type="checkbox"/> <b>YES</b> <input type="checkbox"/> <b>NO</b> Describe more specific faults and/or other information	
<b>Date</b>		<b>Sign</b>

<b>Test Case</b>	<b>Task 2:3 Quality reception detector</b>	
<b>Section</b>	NorDig Unified 3.1.3	
<b>Requirement</b>	The NorDig Unified receiver shall be equipped with a reception quality detector.	
<b>IRD profile(s)</b>	Basic, IRD, DVB-C	
<b>Test procedure</b>	<p><b>Test procedure:</b> Check that the IRD is equipped with a reception quality detector</p> <p><b>Expected result:</b> It shall be possible to access some kind of a reception quality detector</p>	
<b>Test result(s)</b>		
<b>Conformity</b>	<input type="checkbox"/> <b>OK Fault</b> <input type="checkbox"/> Major <input type="checkbox"/> Minor, define fail reason in comments	
<b>Comments</b>	If possible describe if fault can be fixed with software update: <input type="checkbox"/> <b>YES</b> <input type="checkbox"/> <b>NO</b> Describe more specific faults and/or other information	
<b>Date</b>		<b>Sign</b>

<b>Test Case</b>	<b>Task 2:4 RF Characteristics: Input frequency range and input level, Digital channels</b>	
<b>Section</b>	NorDig Unified 3.3.2	
<b>Requirement</b>	The IRD shall have RF characteristics equal to or better than specified below:    Input Frequency range: Digital signals    110 - 862 MHz	
<b>IRD profile(s)</b>	Basic, IRD, DVB-C	

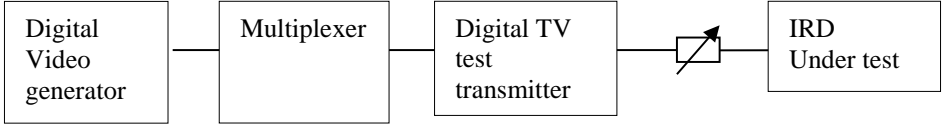
<b>Test procedure</b>	<p><b>Equipment:</b></p>  <pre> graph LR     DVG[Digital Video generator] --- M[Multiplexer]     M --- DTT[Digital TV test transmitter]     DTT --- DC[Directional Coupler]     DC --- IRD[IRD Under test]           </pre> <p><b>Test procedure:</b></p> <ol style="list-style-type: none"> <li>6. Configure wanted signal to center frequency 114 MHz, 16 QAM, SR 6.952 Msymb/s at level 60 dB<math>\mu</math>V.</li> <li>7. Power on IRD.</li> <li>8. Make a channel search at wanted signal and verify that IRD locks to carrier and decodes picture without any visible degradation.</li> <li>9. Use quality measurement procedure 2 (QMP2).</li> <li>10. Repeat the test for the signal levels, center frequencies and DVB-C modes in the measurement record.</li> </ol> <p><b>Expected result:</b> IRD locks to carrier and decodes picture without any visible degradation</p>																																																	
<b>Test result(s)</b>	<p>Measurement record</p> <p>Result OK/NOK:</p> <table border="1"> <thead> <tr> <th>Frequency</th> <th colspan="3">114 MHz</th> <th colspan="3">858 MHz</th> </tr> </thead> <tbody> <tr> <td>Modulation / Signal Level [dB<math>\mu</math>V]</td> <td>60</td> <td>47</td> <td>77</td> <td>60</td> <td>47</td> <td>77</td> </tr> <tr> <td>16 QAM</td> <td></td> <td></td> <td></td> <td></td> <td></td> <td></td> </tr> <tr> <td>128 QAM</td> <td></td> <td></td> <td></td> <td></td> <td></td> <td></td> </tr> <tr> <td>256 QAM</td> <td></td> <td></td> <td></td> <td></td> <td></td> <td></td> </tr> <tr> <td>Modulation / Signal Level [dB<math>\mu</math>V]</td> <td>60</td> <td>43</td> <td>73</td> <td>60</td> <td>43</td> <td>73</td> </tr> <tr> <td>64 QAM</td> <td></td> <td></td> <td></td> <td></td> <td></td> <td></td> </tr> </tbody> </table>	Frequency	114 MHz			858 MHz			Modulation / Signal Level [dB $\mu$ V]	60	47	77	60	47	77	16 QAM							128 QAM							256 QAM							Modulation / Signal Level [dB $\mu$ V]	60	43	73	60	43	73	64 QAM						
Frequency	114 MHz			858 MHz																																														
Modulation / Signal Level [dB $\mu$ V]	60	47	77	60	47	77																																												
16 QAM																																																		
128 QAM																																																		
256 QAM																																																		
Modulation / Signal Level [dB $\mu$ V]	60	43	73	60	43	73																																												
64 QAM																																																		
<b>Conformity</b>	<input type="checkbox"/> OK <input type="checkbox"/> Fault <input type="checkbox"/> Major <input type="checkbox"/> Minor, define fail reason in comments																																																	
<b>Comments</b>	<p>If possible describe if fault can be fixed with software update: <input type="checkbox"/> YES <input type="checkbox"/> NO</p> <p>Describe more specific faults and/or other information</p>																																																	
<b>Date</b>	<i>Sign</i>																																																	

<b>Test Case</b>	<b>Task 2:5 RF Characteristics: Symbol rate and modulation</b>
<b>Section</b>	NorDig Unified 3.3.2
<b>Requirement</b>	<p>The IRD shall have RF characteristics equal to or better than specified below:</p> <p>Symbolrate: Digital signals 4 Msymbols/s to 7 Msymbols/s. The rates are set in steps of 1 ksymbols/s.</p> <p>Modulation: Digital signals 16-QAM, 64-QAM, 128-QAM and 256-QAM</p>
<b>IRD profile(s)</b>	Basic, IRD, DVB-C

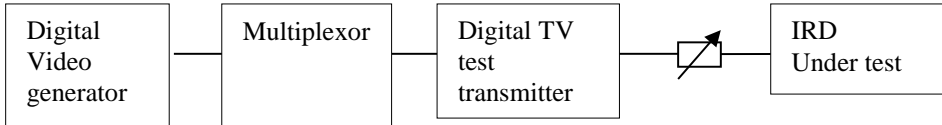
<b>Test procedure</b>	<p><b>Equipment:</b>          Digital Video Generator          TV test transmitter for cable</p>  <pre>         graph LR             A[Digital Video generator] --- B[Multiplexor]             B --- C[Digital TV test transmitter]             C --- D[IRD Under test]         </pre> <p><b>Test procedure:</b></p> <ol style="list-style-type: none"> <li>1. Configure wanted signal to center frequency 666 MHz, 16 QAM, SR 4.000 Msymb/s at level 60 dB<math>\mu</math>V.</li> <li>2. Power on IRD.</li> <li>3. Make a channel search at wanted signal and verify that IRD locks to carrier and decodes picture without any visible degradation.</li> <li>4. Use quality measurement procedure 2 (QMP2).</li> <li>5. Repeat the test for the DVB-C modes in the measurement record.</li> </ol> <p><b>Expected result:</b>          IRD locks to carrier and decodes picture without any visible degradation and the symbol rate is settable in 1 ksymbols/s steps.</p>																				
<b>Test result(s)</b>	<p>Measurement record</p> <p>Status OK/NOK:</p> <table border="1" data-bbox="387 983 1120 1176"> <tr> <td>Modulation / Symbol Rate [Msymb/s]</td> <td>4.000</td> <td>4.100</td> <td>7.000</td> </tr> <tr> <td>16 QAM</td> <td></td> <td></td> <td></td> </tr> <tr> <td>64 QAM</td> <td></td> <td></td> <td></td> </tr> <tr> <td>128 QAM</td> <td></td> <td></td> <td></td> </tr> <tr> <td>256 QAM</td> <td></td> <td></td> <td></td> </tr> </table>	Modulation / Symbol Rate [Msymb/s]	4.000	4.100	7.000	16 QAM				64 QAM				128 QAM				256 QAM			
Modulation / Symbol Rate [Msymb/s]	4.000	4.100	7.000																		
16 QAM																					
64 QAM																					
128 QAM																					
256 QAM																					
<b>Conformity</b>	<input type="checkbox"/> <b>OK Fault</b> <input type="checkbox"/> Major <input type="checkbox"/> Minor, define fail reason in comments																				
<b>Comments</b>	If possible describe if fault can be fixed with software update: <input type="checkbox"/> <b>YES</b> <input type="checkbox"/> <b>NO</b> Describe more specific faults and/or other information																				
<b>Date</b>	<b>Sign</b>																				

<b>Test Case</b>	<b>Task 2:6 RF Characteristics: Input impedance</b>
<b>Section</b>	NorDig Unified 3.3.2
<b>Requirement</b>	The IRD shall have RF characteristics equal to or better than specified below: Input connector : IEC 61169-2, female, 75 Ohms
<b>IRD profile(s)</b>	Basic, IRD, DVB-C
<b>Test procedure</b>	The manufacturer verifies that the input impedance is 75 Ohms.
<b>Test result(s)</b>	
<b>Conformity</b>	<input type="checkbox"/> <b>OK Fault</b> <input type="checkbox"/> Major <input type="checkbox"/> Minor, define fail reason in comments
<b>Comments</b>	If possible describe if fault can be fixed with software update: <input type="checkbox"/> <b>YES</b> <input type="checkbox"/> <b>NO</b> Describe more specific faults and/or other information
<b>Date</b>	<b>Sign</b>

<b>Task 2:7 RF bypass</b>	
<b>Section</b>	NorDig Unified 3.3.3
<b>Requirement</b>	<p>The RF signals should be bypassed from RF<sub>in</sub> to RF<sub>out</sub> independently from the status of the NorDig IRD (operational or stand by), so that connected equipment can operate even if the NorDig IRD is in stand by.</p> <p>The frequency range for the RF bypass shall be from 47 MHz to 862 MHz. The NorDig IRD, when equipped with RF bypass, should include user setting to disable or enable the RF bypass gain in stand-by mode. When the RF bypass gain is disabled, the maximum RF bypass gain should -4dB and when the RF bypass gain is enabled, the RF bypass gain should be from -1 dB to +3 dB. The degradation of the signals caused by the RF bypass compared to the input signal shall be less than:</p> <ul style="list-style-type: none"> <li>o 1 dB in case of signal-to-noise ratio</li> </ul>
<b>IRD profile(s)</b>	Basic, IRD, DVB-C
<b>Test procedure</b>	<p><b>Purpose of test:</b> To verify that IRDs RF bypass is according the specification.</p> <p><b>Equipment:</b> IRD Under test Measurement equipment</p> <p><b>Test procedure:</b></p> <ol style="list-style-type: none"> <li>1. Generate one digital channel (64 QAM, 6,952 MS/s, 015 roll-off) at 114 MHz with three different input levels, 60 dBμV, 43 dBμV and 73 dBμV.</li> <li>2. Verify that the RF<sub>out</sub> signal level is less than 1dB below and less than 3dB above the signal level at the RF<sub>in</sub></li> <li>3. Generate one digital channel (64 QAM, 6,952 MS/s, 015 roll-off) at 858 MHz. Make the test for three different input levels, 60 dBμV, 43 dBμV and 73 dBμV.</li> <li>4. Verify that the RF<sub>out</sub> signal level is less than 1dB below and less than 3dB above the signal level at the RF<sub>in</sub></li> </ol> <p><b>Expected results:</b> The IRDs RF output is according the requirements.</p>
<b>Test result(s)</b>	
<b>Conformity</b>	<input type="checkbox"/> OK <b>Fault</b> <input type="checkbox"/> Major <input type="checkbox"/> Minor, define fail reason in comments
<b>Comments</b>	If possible describe if fault can be fixed with software update: <input type="checkbox"/> YES <input type="checkbox"/> NO Describe more specific faults and/or other information
<b>Date</b>	<b>Sign</b>

<b>Test Case</b>	<b>Task 2:8 Tuning/Scanning procedure (Automatic scan based on NIT)</b>
<b>Section</b>	NorDig Unified 3.3.4



<b>Requirement</b>	<p>The NIT scanning shall be able to find all the available channels on the network. During the first boot sequence or any time the IRD is re-installed, it will begin scanning for the Network Information Table using the following parameters:</p> <p>Center frequencies: 114 MHz onwards in 8MHz steps until 858 MHz.  Modulations: 64 QAM, 128 QAM and 256 QAM  Symbol rates: 6.952 MSymbols/s (first attempt). If this rate does not result in reception, the following rates should be attempted: 6.950, 6.900, 6.875, 6.125 and 6.000 Msymbols/s.</p> <p>Modulation mode: 16 QAM, 64QAM, 128QAM and 256QAM, where 128QAM and 16 QAM should be attempted last.</p> <p>The scanning shall stop as soon as a valid Network Information Table (NIT_actual) is found. After that the NIT scanning procedure will continue according to information acquired from NIT.</p>
<b>IRD profile(s)</b>	Basic, IRD, DVB-C
<b>Test procedure</b>	<p><b>Equipment:</b>  Use the CATV network.  The NIT shall describe all the digital channels.</p> <p><b>Test procedure:</b></p> <ol style="list-style-type: none"> <li>1. Generate a cable TV signal with following parameters: <ol style="list-style-type: none"> <li>a) MUX1: Frequency 842 MHz, 256 QAM, Symbol Rate 6.000 MSymbols/s</li> <li>b) MUX 2: Frequency 858 MHz, 64 QAM, Symbol Rate 6.952 MSymbols/s</li> </ol> </li> <li>2. Make a new installation of the IRD.</li> <li>3. Verify that the channel search is implemented according specification and finds all channels.</li> </ol> <p><b>Expected result:</b></p> <p>All digital channels in the network shall be found and the search is implemented according specification.</p>
<b>Test result(s)</b>	
<b>Conformity</b>	<input type="checkbox"/> OK Fault <input type="checkbox"/> Major <input type="checkbox"/> Minor, define fail reason in comments
<b>Comments</b>	If possible describe if fault can be fixed with software update: <input type="checkbox"/> YES <input type="checkbox"/> NO Describe more specific faults and/or other information
<b>Date</b>	<b>Sign</b>

<b>Test Case</b>	<b>Task 2:9 Tuning/Scanning procedure (Manual scan)</b>
<b>Section</b>	NorDig Unified 3.3.4
<b>Requirement</b>	The receiver shall also offer manual scanning feature, where different scanning parameters may be used.
<b>IRD profile(s)</b>	Basic, IRD, DVB-C

<b>Test procedure</b>	<p><b>Equipment:</b> Use the ordinary CATV network.</p> <p><b>Test procedure:</b> Make a new installation of the IRD by using manual scanning. Install a couple of multiplexes one by one using manual scanning</p> <p><b>Expected result:</b> All digital channels in the selected multiplexes are added to the channel list.</p>		
<b>Test result(s)</b>			
<b>Conformity</b>	<input type="checkbox"/> <b>OK Fault</b> <input type="checkbox"/> Major <input type="checkbox"/> Minor, define fail reason in comments		
<b>Comments</b>	If possible describe if fault can be fixed with software update: <input type="checkbox"/> <b>YES</b> <input type="checkbox"/> <b>NO</b> Describe more specific faults and/or other information		
<b>Date</b>		<b>Sign</b>	

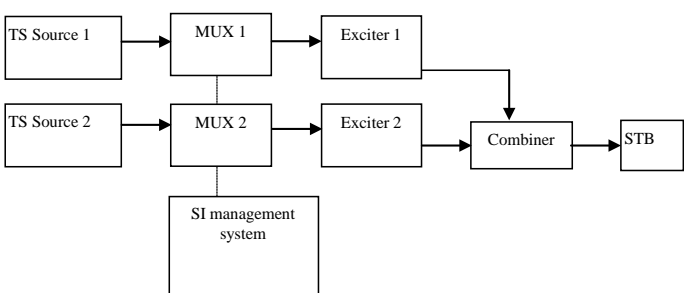
<b>Test Case</b>	<b>Task 2:10 Tuning/Scanning procedure (Original_network_id, transport_stream_id and service_id triplet support)</b>																		
<b>Section</b>	NorDig Unified 3.3.4																		
<b>Requirement</b>	In the case where two transmitters transmit unique services which share the same service_id but the triplet on_id/ts_id/s_id is different. Then these services must be recognized as separate services and shall be added to the channel list accordingly.																		
<b>IRD profile(s)</b>	Basic, IRD, DVB-C																		
<b>Test procedure</b>	<p><b>Equipment:</b></p>  <pre> graph LR     TS1[TS Source 1] --&gt; MUX1[MUX 1]     TS2[TS Source 2] --&gt; MUX2[MUX 2]     MUX1 --&gt; Exc1[Exciter 1]     MUX2 --&gt; Exc2[Exciter 2]     Exc1 --&gt; Comb[Combiner]     Exc2 --&gt; Comb     Comb --&gt; STB[STB]     SI[SI management system] --- MUX1     SI --- MUX2     </pre> <table border="1" data-bbox="391 1624 1345 2016"> <thead> <tr> <th></th> <th><b>Service1</b></th> <th><b>Service2</b></th> <th></th> <th><b>Frequency</b></th> </tr> </thead> <tbody> <tr> <td><b>MUX1</b> TS_id 1 ON_id 1</td> <td>SID 1100 S_name Test11 PMT PID 1100 V PID 1109 A PID 1108 LCN 1</td> <td>SID 1200 S_name Test12 PMT PID 1200 V PID 1209 A PID 1208 LCN 3</td> <td></td> <td>Can be chosen depending of the distribution media.</td> </tr> <tr> <td><b>MUX2</b> TS_id 2 ON_id 1</td> <td>SID 1100 S_name Test21 PMT PID 2100 V PID 2109 A PID 2108 LCN 2</td> <td></td> <td></td> <td>Can be chosen depending of the distribution media. Not same as for Exciter 1</td> </tr> </tbody> </table>					<b>Service1</b>	<b>Service2</b>		<b>Frequency</b>	<b>MUX1</b> TS_id 1 ON_id 1	SID 1100 S_name Test11 PMT PID 1100 V PID 1109 A PID 1108 LCN 1	SID 1200 S_name Test12 PMT PID 1200 V PID 1209 A PID 1208 LCN 3		Can be chosen depending of the distribution media.	<b>MUX2</b> TS_id 2 ON_id 1	SID 1100 S_name Test21 PMT PID 2100 V PID 2109 A PID 2108 LCN 2			Can be chosen depending of the distribution media. Not same as for Exciter 1
	<b>Service1</b>	<b>Service2</b>		<b>Frequency</b>															
<b>MUX1</b> TS_id 1 ON_id 1	SID 1100 S_name Test11 PMT PID 1100 V PID 1109 A PID 1108 LCN 1	SID 1200 S_name Test12 PMT PID 1200 V PID 1209 A PID 1208 LCN 3		Can be chosen depending of the distribution media.															
<b>MUX2</b> TS_id 2 ON_id 1	SID 1100 S_name Test21 PMT PID 2100 V PID 2109 A PID 2108 LCN 2			Can be chosen depending of the distribution media. Not same as for Exciter 1															

	<p><b>Test procedure:</b> Make a new installation of the box with automatic scan selected.</p> <p><b>Expected result:</b> All digital channels in the network shall be found in following order:</p> <table border="1" data-bbox="387 461 721 591"> <thead> <tr> <th>LCN</th> <th>Service</th> </tr> </thead> <tbody> <tr> <td>1.</td> <td>Test11</td> </tr> <tr> <td>2.</td> <td>Test21</td> </tr> <tr> <td>3.</td> <td>Test12</td> </tr> </tbody> </table>		LCN	Service	1.	Test11	2.	Test21	3.	Test12
LCN	Service									
1.	Test11									
2.	Test21									
3.	Test12									
<b>Test result(s)</b>										
<b>Conformity</b>	<input type="checkbox"/> <b>OK Fault</b> <input type="checkbox"/> Major <input type="checkbox"/> Minor, define fail reason in comments									
<b>Comments</b>	If possible describe if fault can be fixed with software update: <input type="checkbox"/> <b>YES</b> <input type="checkbox"/> <b>NO</b> Describe more specific faults and/or other information									
<b>Date</b>		<b>Sign</b>								

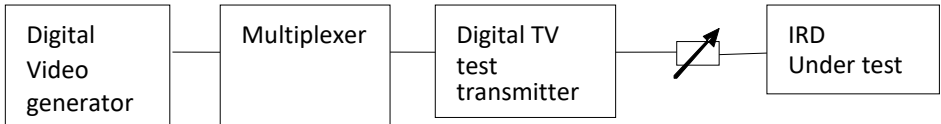
	<b>Task 2:11 Tuning/Scanning procedure – Network default values</b>	
<b>Section</b>	NorDig Unified 3.3.4	
<b>Requirement</b>	<p>It shall be possible to set and store specific <i>network default values</i> for search of digital carriers, as required for the targeted network(s). The values shall be set either manually via the user interface, or as part of the stored default values in the NorDig IRD.</p> <p>The <i>network default</i> values shall for each stored network id include:</p> <ul style="list-style-type: none"> <li>o Network id</li> <li>o Frequency (ies) and modulation mode(s) for carriers that carry service information about actual and other transport streams, see section 13.2.2 (NorDig Unified)</li> <li>o Symbol rate(s) for the specified carrier(s).</li> </ul>	
<b>IRD profile(s)</b>	Basic, IRD, DVB-C	
<b>Test procedure</b>	<p><b>Purpose of test:</b> To verify that IRD supports network default values</p> <p><b>Equipment:</b></p> <div style="text-align: center;">  <pre> graph LR     A[Digital Video generator] --- B[Multiplexer]     B --- C[Digital TV test transmitter]     C --- D[IR Under test]     </pre> </div> <p><b>Test procedure:</b> Verify that the network default values can be set and are used to make the NIT based scan</p> <p><b>Expected results:</b> The IRD has the network default values and they are used for NIT based scanning.</p>	

<b>Test result(s)</b>	
<b>Conformity</b>	<input type="checkbox"/> OK <b>Fault</b> <input type="checkbox"/> Major <input type="checkbox"/> Minor, define fail reason in comments
<b>Comments</b>	If possible describe if fault can be fixed with software update: <input type="checkbox"/> YES <input type="checkbox"/> NO Describe more specific faults and/or other information
<b>Date</b>	<b>Sign</b>

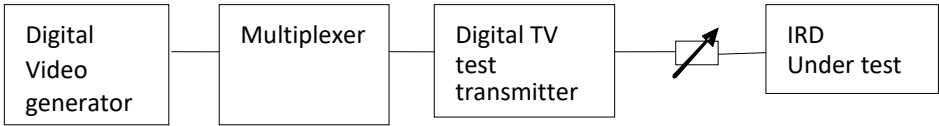
<b>Task 2:12 Tuning/Scanning procedure – Factory default values</b>	
<b>Section</b>	NorDig Unified 3.3.4
<b>Requirement</b>	In case there are no stored data for the selected network, the stored factory default values shall be used for the initial search (Step 1 above). In case these default values do not result in reception of a carrier, a full search, covering all frequencies, modulation modes and symbol rates shall be performed (Step 2). The NorDig IRD shall as a minimum store a factory default value set, with the following data: <ul style="list-style-type: none"> <li>Carrier frequencies: 114MHz + n x 8MHz, where n is an integer in the range 0 to 93, see Table 3.3.</li> <li>Modulation mode: 16 QAM, 64QAM, 128QAM and 256QAM, where 128QAM and 16 QAM should be attempted last.</li> <li>Symbol rate: 6.952 MSymbols/s (first attempt). If this rate does not result in reception, the following rates should be attempted: 6.950, 6.900, 6.875, 6.125 (1) and 6.000 (1) Msymbols/s.</li> </ul>
<b>IRD profile(s)</b>	Basic, IRD, DVB-C
<b>Test procedure</b>	<p><b>Purpose of test:</b> To verify that IRD supports factory default values</p> <p><b>Equipment:</b></p>  <pre> graph LR     DVG[Digital Video generator] --- M[Multiplexer]     M --- DTT[Digital TV test transmitter]     DTT --- Antenna[Antenna]     Antenna --- IRD[IRD Under test]   </pre> <p><b>Test procedure:</b> Verify that the factory default values are stored and are used to make the NIT based scan</p> <p><b>Expected results:</b> The IRD has the factory default values and they are used for NIT based scanning.</p>
<b>Test result(s)</b>	
<b>Conformity</b>	<input type="checkbox"/> OK <b>Fault</b> <input type="checkbox"/> Major <input type="checkbox"/> Minor, define fail reason in comments
<b>Comments</b>	If possible describe if fault can be fixed with software update: <input type="checkbox"/> YES <input type="checkbox"/> NO Describe more specific faults and/or other information
<b>Date</b>	<b>Sign</b>

<b>Task 2:13 Total input power</b>	
<b>Section</b>	NorDig Unified 3.3.2.1
<b>Requirement</b>	The NorDig IRD shall operate with input network and channel RF characteristics as specified in Table 3.3  Total Input Power (80-862 MHz): Digital & analogue < 93 dBμV at 75 Ohms

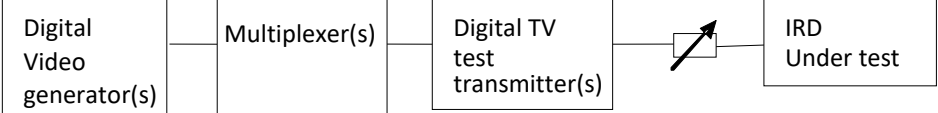
<b>IRD profile(s)</b>	Basic, IRD, DVB-C	
<b>Test procedure</b>	<p><b>Purpose of test:</b> To verify that IRD can operate with required total input power</p> <p><b>Equipment:</b> IRD Under test and test signal generator environment</p>  <pre> graph LR     A[Digital Video generator(s)] --- B[Multiplexer(s)]     B --- C[Digital TV test transmitter(s)]     C --- D[IRD Under test]     E[Directional Coupler] --- C     E --- D   </pre> <p><b>Test procedure:</b></p> <ol style="list-style-type: none"> <li>1. Configure wanted signal to center frequency 666 MHz, 256 QAM, SR 6.952 Msymb/s at level 77 dB<math>\mu</math>V</li> <li>2. Configure interference signal to center frequencies n-1 (658MHz) and n+1 (674 MHz), 256QAM, SR 6.952 Msymb/sat level 77 dB<math>\mu</math>V</li> <li>3. Configure interference signal to center frequencies n-2(650MHz) and n+2(682MHz) , 256QAM, SR 6.952 Msymb/sat level 82 dB<math>\mu</math>V</li> <li>4. Power on IRD</li> <li>5. Make a channel search at wanted signal and verify that IRD locks to carrier, finds all channels and decodes picture without any visible degradation.</li> <li>6. Use quality measurement procedure 2 (QMP2).</li> </ol> <p><b>Expected results:</b> The IRDlocks to carrier and decodes picture without any visible degradation with required total power</p>	
<b>Test result(s)</b>		
<b>Conformity</b>	<input type="checkbox"/> OK <input type="checkbox"/> Fault <input type="checkbox"/> Major <input type="checkbox"/> Minor, define fail reason in comments	
<b>Comments</b>	If possible describe if fault can be fixed with software update: <input type="checkbox"/> YES <input type="checkbox"/> NO Describe more specific faults and/or other information	
<b>Date</b>		<b>Sign</b>

	<b>Task 2:14 RF Performance - C/N for Reference BER</b>	
<b>Section</b>	NorDig Unified 3.3.5.3	
<b>Requirement</b>	The NorDig IRD shall operate with input network and channel RF characteristics as specified in Table 3.4 in NorDig Unified specification [1]	
<b>IRD profile(s)</b>	Basic, IRD, DVB-C	
<b>Test procedure</b>	<p><b>Purpose of test:</b> To check that the internal BER value measured by the receiver to reference BER value in a function of C/N on Gaussian channel is correct.</p> <p><b>Equipment:</b></p>	

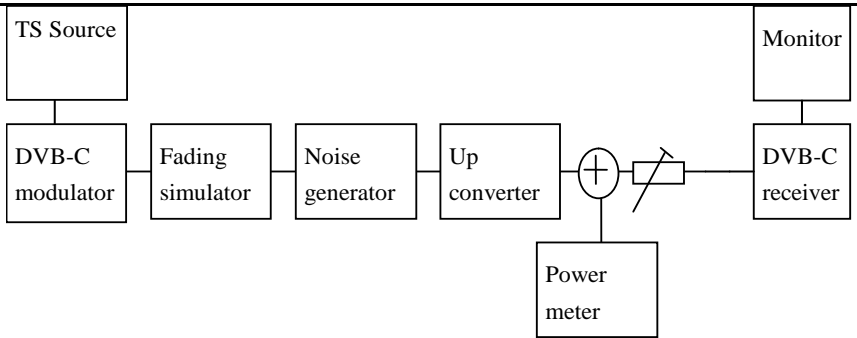
																														
	<p><b>Test procedure:</b></p> <ol style="list-style-type: none"> <li>1. Setup the instruments.</li> <li>2. Use frequency 666 MHz and mode 256QAM, SR 6.952 Msymb/s. Set the RF input level to 47dB<math>\mu</math>V.</li> <li>3. Use the quality measurement procedure 2.</li> <li>4. Adjust the required C/N that it corresponds BER 2E-4 after Viterbi.</li> <li>5. Repeat test with all values in the measurement record table below. For modulations 128QAM, 64QAM and 16QAM use SR 6.952 Msymb/s.</li> </ol> <p><b>Expected result:</b> The resulted C/N shall be lower than the required C/N for quality level BER 2E-4 after Viterbi in all tests in measurement record.</p>																													
<b>Test result(s)</b>	<p>Measurement record:</p> <table border="1" style="width: 100%; border-collapse: collapse;"> <thead> <tr> <th>QAM:</th> <th>Level/ dB<math>\mu</math>V</th> <th>Required C/N (Es/No):</th> <th>Result C/N</th> </tr> </thead> <tbody> <tr> <td rowspan="4">256</td> <td>54</td> <td>32.0 dB</td> <td></td> </tr> <tr> <td>77</td> <td>32.0 dB</td> <td></td> </tr> <tr> <td>47</td> <td>35.0 dB</td> <td></td> </tr> <tr> <td>53</td> <td>35.0 dB</td> <td></td> </tr> <tr> <td>128</td> <td>47</td> <td>29.0 dB</td> <td></td> </tr> <tr> <td>64</td> <td>43</td> <td>26.0 dB</td> <td></td> </tr> <tr> <td>16</td> <td>47</td> <td>20.0 dB</td> <td></td> </tr> </tbody> </table>	QAM:	Level/ dB $\mu$ V	Required C/N (Es/No):	Result C/N	256	54	32.0 dB		77	32.0 dB		47	35.0 dB		53	35.0 dB		128	47	29.0 dB		64	43	26.0 dB		16	47	20.0 dB	
QAM:	Level/ dB $\mu$ V	Required C/N (Es/No):	Result C/N																											
256	54	32.0 dB																												
	77	32.0 dB																												
	47	35.0 dB																												
	53	35.0 dB																												
128	47	29.0 dB																												
64	43	26.0 dB																												
16	47	20.0 dB																												
<b>Conformity</b>	<input type="checkbox"/> <b>OK</b> <input type="checkbox"/> <b>Fault</b> <input type="checkbox"/> Major <input type="checkbox"/> Minor, define fail reason in comments																													
<b>Comments</b>	If possible describe if fault can be fixed with software update: <input type="checkbox"/> <b>YES</b> <input type="checkbox"/> <b>NO</b> Describe more specific faults and/or other information																													
<b>Date</b>	<table border="1" style="width: 100%; border-collapse: collapse;"> <tr> <td style="width: 60%;"></td> <td style="width: 40%; text-align: center;"><i>Sign</i></td> </tr> </table>		<i>Sign</i>																											
	<i>Sign</i>																													

	<b>Task 2:15 RF Performace - C/N with echo</b>
<b>Section</b>	NorDig Unified 3.3.5.4
<b>Requirement</b>	The NorDig IRD shall perform as specified in Table 3.3, plus an allowance of 1 dB when an echo is applied in accordance to the template in Figure 3.1.
<b>IRD profile(s)</b>	Basic, IRD, DVB-C

**Test procedure**

**Purpose of test:**

To verify the required C/N when echoes are present.

**Equipment:**

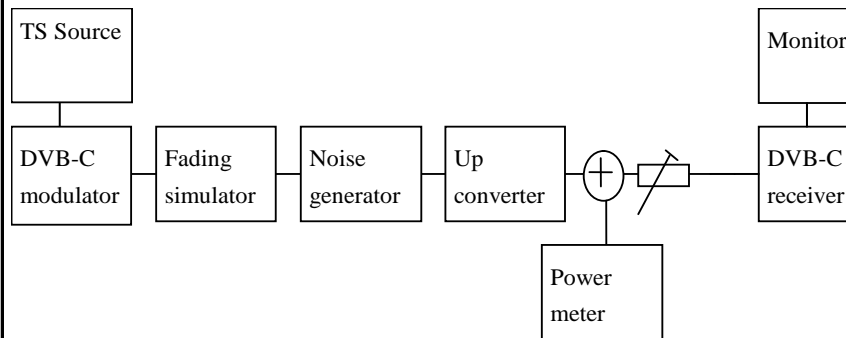

**Test procedure:**

1. Set up the test instruments
2. Use the following settings {256 QAM, SR=6.952, 666 Mhz, delay 0 ns}
3. Measure the input level to the attenuator.
4. Determine the attenuation of the attenuator and the cables.
5. Calculate the receiver input signal level and set it to 54dB $\mu$ V.
6. Use the value for the required C/N+1 dB specified in table 3.4 in NorDig Unified specification [1].
7. Do the channel search.
8. Increase the C/N from low value to higher value until the quality measurement procedure 2 fulfils.
9. Fill in the measured value in dB in the measurement record.
10. Repeat the test for the rest of the modes and delays defined in the measurement record.

**Expected result:**

The measured C/N shall be within required C/N + 1 dB.



<b>Test result(s)</b>	<table border="1" style="width: 100%; border-collapse: collapse;"> <thead> <tr> <th colspan="2">Echo / Mode, Level</th> <th>16-QAM</th> <th>64-QAM</th> </tr> <tr> <th>Att. [dB]</th> <th>Delay [ns]</th> <th>47 dB<math>\mu</math>V</th> <th>43 dB<math>\mu</math>V</th> </tr> </thead> <tbody> <tr><td>6.0</td><td>0</td><td></td><td></td></tr> <tr><td>6.6</td><td>40</td><td></td><td></td></tr> <tr><td>7.7</td><td>50</td><td></td><td></td></tr> <tr><td>13.4</td><td>100</td><td></td><td></td></tr> <tr><td>19.0</td><td>150</td><td></td><td></td></tr> <tr><td>24.7</td><td>200</td><td></td><td></td></tr> <tr><td>30.3</td><td>250</td><td></td><td></td></tr> <tr><td>33.7</td><td>280</td><td></td><td></td></tr> <tr><td>36.0</td><td>300</td><td></td><td></td></tr> <tr><td>36.0</td><td>350</td><td></td><td></td></tr> </tbody> </table> <table border="1" style="width: 100%; border-collapse: collapse;"> <thead> <tr> <th colspan="2">Echo / Mode, Level</th> <th>128-QAM</th> </tr> <tr> <th>Att. [dB]</th> <th>Delay [ns]</th> <th>47 dB<math>\mu</math>V</th> </tr> </thead> <tbody> <tr><td>9.0</td><td>0</td><td></td></tr> <tr><td>9.6</td><td>40</td><td></td></tr> <tr><td>10.7</td><td>50</td><td></td></tr> <tr><td>16.4</td><td>100</td><td></td></tr> <tr><td>22.0</td><td>150</td><td></td></tr> <tr><td>27.7</td><td>200</td><td></td></tr> <tr><td>33.3</td><td>250</td><td></td></tr> <tr><td>36.7</td><td>280</td><td></td></tr> <tr><td>39.0</td><td>300</td><td></td></tr> <tr><td>39.0</td><td>350</td><td></td></tr> </tbody> </table> <table border="1" style="width: 100%; border-collapse: collapse;"> <thead> <tr> <th colspan="2">Echo / Mode, Level</th> <th colspan="2">256-QAM</th> </tr> <tr> <th>Att. [dB]</th> <th>Delay [ns]</th> <th>47 dB<math>\mu</math>V</th> <th>54 dB<math>\mu</math>V</th> </tr> </thead> <tbody> <tr><td>12.0</td><td>0</td><td></td><td></td></tr> <tr><td>12.6</td><td>40</td><td></td><td></td></tr> <tr><td>13.7</td><td>50</td><td></td><td></td></tr> <tr><td>19.4</td><td>100</td><td></td><td></td></tr> <tr><td>25.0</td><td>150</td><td></td><td></td></tr> <tr><td>30.7</td><td>200</td><td></td><td></td></tr> <tr><td>36.3</td><td>250</td><td></td><td></td></tr> <tr><td>39.7</td><td>280</td><td></td><td></td></tr> <tr><td>42.0</td><td>300</td><td></td><td></td></tr> <tr><td>42.0</td><td>350</td><td></td><td></td></tr> </tbody> </table>				Echo / Mode, Level		16-QAM	64-QAM	Att. [dB]	Delay [ns]	47 dB $\mu$ V	43 dB $\mu$ V	6.0	0			6.6	40			7.7	50			13.4	100			19.0	150			24.7	200			30.3	250			33.7	280			36.0	300			36.0	350			Echo / Mode, Level		128-QAM	Att. [dB]	Delay [ns]	47 dB $\mu$ V	9.0	0		9.6	40		10.7	50		16.4	100		22.0	150		27.7	200		33.3	250		36.7	280		39.0	300		39.0	350		Echo / Mode, Level		256-QAM		Att. [dB]	Delay [ns]	47 dB $\mu$ V	54 dB $\mu$ V	12.0	0			12.6	40			13.7	50			19.4	100			25.0	150			30.7	200			36.3	250			39.7	280			42.0	300			42.0	350		
Echo / Mode, Level		16-QAM	64-QAM																																																																																																																																					
Att. [dB]	Delay [ns]	47 dB $\mu$ V	43 dB $\mu$ V																																																																																																																																					
6.0	0																																																																																																																																							
6.6	40																																																																																																																																							
7.7	50																																																																																																																																							
13.4	100																																																																																																																																							
19.0	150																																																																																																																																							
24.7	200																																																																																																																																							
30.3	250																																																																																																																																							
33.7	280																																																																																																																																							
36.0	300																																																																																																																																							
36.0	350																																																																																																																																							
Echo / Mode, Level		128-QAM																																																																																																																																						
Att. [dB]	Delay [ns]	47 dB $\mu$ V																																																																																																																																						
9.0	0																																																																																																																																							
9.6	40																																																																																																																																							
10.7	50																																																																																																																																							
16.4	100																																																																																																																																							
22.0	150																																																																																																																																							
27.7	200																																																																																																																																							
33.3	250																																																																																																																																							
36.7	280																																																																																																																																							
39.0	300																																																																																																																																							
39.0	350																																																																																																																																							
Echo / Mode, Level		256-QAM																																																																																																																																						
Att. [dB]	Delay [ns]	47 dB $\mu$ V	54 dB $\mu$ V																																																																																																																																					
12.0	0																																																																																																																																							
12.6	40																																																																																																																																							
13.7	50																																																																																																																																							
19.4	100																																																																																																																																							
25.0	150																																																																																																																																							
30.7	200																																																																																																																																							
36.3	250																																																																																																																																							
39.7	280																																																																																																																																							
42.0	300																																																																																																																																							
42.0	350																																																																																																																																							
<b>Conformity</b>	<input type="checkbox"/> <b>OK</b> <input type="checkbox"/> <b>Fault</b> <input type="checkbox"/> Major <input type="checkbox"/> Minor, define fail reason in comments																																																																																																																																							
<b>Comments</b>	If possible describe if fault can be fixed with software update: <input type="checkbox"/> <b>YES</b> <input type="checkbox"/> <b>NO</b> Describe more specific faults and/or other information																																																																																																																																							
<b>Date</b>			<b>Sign</b>																																																																																																																																					

<b>Test Case</b>	<b>Task 2:16 Performance Data: Noise figure</b>
<b>Section</b>	NorDig Unified 3.3.5.1
<b>Requirement</b>	The performance data below shall be satisfied: Noise figure: less than 8 dB.
<b>IRD profile(s)</b>	Basic, IRD, DVB-C



**Test procedure**

**Purpose of test:**

To verify the receiver noise figure performance.

**Equipment:**

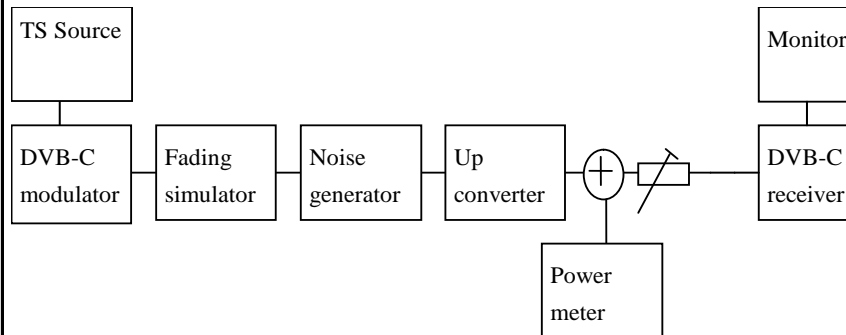

**Test procedure:**

1. Set up the test instruments
2. Use the following settings {256 QAM, SR=6.952 , roll-off 0.15}.
3. Use the channel K45 (666 MHz)
4. Measure the input level to the attenuator.
5. Determine the attenuation of the attenuator and the cables.
6. Calculate the receiver input signal level and set it to 59 dB $\mu$ V.
7. Do the channel search.
8. Increase the C/N from low value to higher value until the quality measurement procedure 2 fulfills.
9. Fill in the measured C/N value in dB in the measurement record.
10. Shutdown added noise.
11. Decrease the signal input level to such a level that receiver is not able to provide picture.
12. Increase the signal input level to receiver until the quality measurement procedure 2 fulfills.
13. Fill in the sensitivity P<sub>min</sub> value in dB $\mu$ V in measurement record.
14. Repeat the test for the rest of the frequencies defined in the measurement record.
15. Calculate the NF using formula: NF[dB] = P<sub>min</sub> - C/N - 3.8 dB $\mu$ V

**Expected result:**

Noise figure is lower than 8dB.

**Test result(s)**

Measurement record:

	f [MHz]						
	114	210	282	386	474	666	858
C/N [dB]							
P <sub>min</sub> [dB $\mu$ V]							
NF [dB]							

**Conformity**

OK Fault  Major  Minor, define fail reason in comments



<b>Comments</b>	If possible describe if fault can be fixed with software update: <input type="checkbox"/> YES <input type="checkbox"/> NO Describe more specific faults and/or other information
<b>Date</b>	<b>Sign</b>

<b>Task 2:17 RF Performance - Image Channel</b>																													
<b>Section</b>	NorDig Unified 3.3.5.5																												
<b>Requirement</b>																													
<b>IRD profile(s)</b>	Basic, IRD, DVB-C																												
<b>Test procedure</b>	<p><b>Purpose of test:</b> To verify that IRD can operate with required image channels</p> <p><b>Equipment:</b> IRD Under test and test signal generator environment</p> <pre> graph LR     A[Digital Video generator(s)] --- B[Multiplexer(s)]     B --- C[Digital TV test transmitter(s)]     C --- D[IRD Under test]     </pre> <p><b>Test procedure:</b></p> <ol style="list-style-type: none"> <li>1. Configure wanted signal to center frequency 666 MHz, 256 QAM, SR 6.952 at level 47 dB<math>\mu</math>V</li> <li>2. Configure interference signal to center frequency n-9 (594 MHz), 256 QAM, SR 6.952 Msym/s at level 57 dB<math>\mu</math>V</li> <li>3. Power on IRD</li> <li>4. Make a channel search at wanted signal and verify that IRD locks to carrier, finds all channels and decodes picture without any visible degradation.</li> <li>5. Apply Gaussian noise to the wanted signal.</li> <li>6. Increase the C/N from low value to higher value until the quality measurement procedure 2 (QMP2) fulfills.</li> <li>7. Fill in the measured C/N value in dB in the measurement record.</li> <li>8. Repeat the test procedure for all DVB-C modes in the measurement record for both interference signal frequencies (n-9 and n+9).</li> </ol> <p><b>Expected results:</b> The IRD locks to carrier and decodes picture without any visible degradation. The measured C/N shall be within required C/N + allowances.</p>																												
<b>Test result(s)</b>	<p>Measurement record:</p> <p>Image channel (n-9): 594 MHz</p> <table border="1" style="width: 100%; border-collapse: collapse;"> <thead> <tr> <th>Wanted signal [dB<math>\mu</math>V]</th> <th>Image channel (n-9) [dB<math>\mu</math>V]</th> <th>16 QAM</th> <th>128 QAM</th> <th>256 QAM</th> </tr> </thead> <tbody> <tr> <td>47</td> <td>47</td> <td></td> <td></td> <td></td> </tr> <tr> <td>77</td> <td>77</td> <td></td> <td></td> <td></td> </tr> <tr> <td>47</td> <td>57</td> <td></td> <td></td> <td></td> </tr> <tr> <td>72</td> <td>82</td> <td></td> <td></td> <td></td> </tr> </tbody> </table> <table border="1" style="width: 100%; border-collapse: collapse;"> <tr> <td>Wanted signal [dB<math>\mu</math>V]</td> <td>Image channel (n-9) [dB<math>\mu</math>V]</td> <td><input type="checkbox"/> 64 QAM</td> </tr> </table>	Wanted signal [dB $\mu$ V]	Image channel (n-9) [dB $\mu$ V]	16 QAM	128 QAM	256 QAM	47	47				77	77				47	57				72	82				Wanted signal [dB $\mu$ V]	Image channel (n-9) [dB $\mu$ V]	<input type="checkbox"/> 64 QAM
Wanted signal [dB $\mu$ V]	Image channel (n-9) [dB $\mu$ V]	16 QAM	128 QAM	256 QAM																									
47	47																												
77	77																												
47	57																												
72	82																												
Wanted signal [dB $\mu$ V]	Image channel (n-9) [dB $\mu$ V]	<input type="checkbox"/> 64 QAM																											

	43	43			
	73	73			
	43	53			
	72	82			
	Image channel (n+9): 738 MHz				
	Wanted signal [dBμV]	Image channel (n+9) [dBμV]	16 QAM	128 QAM	256 QAM
	47	47			
	77	77			
	47	57			
	72	82			
Wanted signal [dBμV]	Image channel (n+9) [dBμV]	64 QAM			
43	43				
73	73				
43	53				
72	82				
<b>Conformity</b>	<input type="checkbox"/> <b>OK</b> <input type="checkbox"/> <b>Fault</b> <input type="checkbox"/> Major <input type="checkbox"/> Minor, define fail reason in comments				
<b>Comments</b>	If possible describe if fault can be fixed with software update: <input type="checkbox"/> <b>YES</b> <input type="checkbox"/> <b>NO</b> Describe more specific faults and/or other information				
<b>Date</b>		<b>Sign</b>			

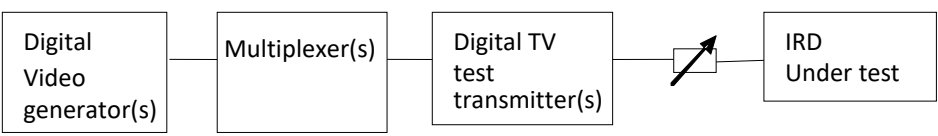
	<b>Task 2:18 RF Performance – Digital Adjacent Channel</b>
<b>Section</b>	NorDig Unified 3.3.5.6 and 3.3.5.7
<b>Requirement</b>	<p>The NorDig IRD shall perform as specified in section 3.3.5.3 with</p> <ul style="list-style-type: none"> <li>a) Digital signals at 0dBc in the adjacent channels.</li> <li>b) Analogue signals at +10dB in the adjacent channels</li> </ul> <p>The NorDig IRD shall perform as specified in section 3.3.5.3, plus an allowance of 0.2 dB with digital signals at +10dBc in adjacent channels.</p>
<b>IRD profile(s)</b>	Basic, IRD, DVB-C
<b>Test procedure</b>	<p><b>Purpose of test:</b> To verify that IRD can operate with required adjacent channels</p> <p><b>Equipment:</b> IRD Under test and test signal generator environment</p> <div style="text-align: center;">  <pre> graph LR     A[Digital Video generator(s)] --&gt; B[Multiplexer(s)]     B --&gt; C[Digital TV test transmitter(s)]     C --&gt; D[IRD Under test]           </pre> </div> <p><b>Test procedure:</b></p> <ol style="list-style-type: none"> <li>1. Configure wanted signal to center frequency 666 MHz, 256 QAM, SR 6.952 Msym/s at level 47 dBμV</li> <li>2. Configure interference signal to center frequencies n+1 (674 MHz) and n-1</li> </ol>

	<p>( 658 MHz), 256 QAM, SR 6.952 Msym/s at level 47 dBμV.</p> <ol style="list-style-type: none"> <li>3. Power on IRD</li> <li>4. Make a channel search at wanted signal and verify that IRD locks to carrier, finds all channels and decodes picture without any visible degradation</li> <li>5. Apply Gaussian noise to the wanted signal.</li> <li>6. Increase the C/N from low value to higher value until the quality measurement procedure 2 (QMP2) fulfills.</li> <li>7. Fill in the measured C/N value in dB in the measurement record.</li> <li>8. Repeat the test for the DVB-C modes and signal levels in the measurement record.</li> </ol> <p><b>Expected results:</b>            The IRD locks to carrier and decodes picture without any visible degradation.            The measured C/N shall be within required C/N + allowances.</p>																																											
<b>Test result(s)</b>	<table border="1" style="width: 100%; border-collapse: collapse; margin-bottom: 10px;"> <thead> <tr> <th style="width: 20%;">Wanted signal [dBμV]</th> <th style="width: 20%;">Adjacent channels (n-1, n+1) [dBμV]</th> <th style="width: 15%;">16 QAM</th> <th style="width: 15%;">128 QAM</th> <th style="width: 15%;">256 QAM</th> </tr> </thead> <tbody> <tr><td>47</td><td>47</td><td></td><td></td><td></td></tr> <tr><td>77</td><td>77</td><td></td><td></td><td></td></tr> <tr><td>47</td><td>57</td><td></td><td></td><td></td></tr> <tr><td>72</td><td>82</td><td></td><td></td><td></td></tr> </tbody> </table> <table border="1" style="width: 100%; border-collapse: collapse;"> <thead> <tr> <th style="width: 20%;">Wanted signal [dBμV]</th> <th style="width: 20%;">Adjacent channels (n-1, n+1) [dBμV]</th> <th style="width: 15%;">64 QAM</th> </tr> </thead> <tbody> <tr><td>43</td><td>43</td><td></td></tr> <tr><td>73</td><td>73</td><td></td></tr> <tr><td>43</td><td>53</td><td></td></tr> <tr><td>72</td><td>82</td><td></td></tr> </tbody> </table>				Wanted signal [dBμV]	Adjacent channels (n-1, n+1) [dBμV]	16 QAM	128 QAM	256 QAM	47	47				77	77				47	57				72	82				Wanted signal [dBμV]	Adjacent channels (n-1, n+1) [dBμV]	64 QAM	43	43		73	73		43	53		72	82	
Wanted signal [dBμV]	Adjacent channels (n-1, n+1) [dBμV]	16 QAM	128 QAM	256 QAM																																								
47	47																																											
77	77																																											
47	57																																											
72	82																																											
Wanted signal [dBμV]	Adjacent channels (n-1, n+1) [dBμV]	64 QAM																																										
43	43																																											
73	73																																											
43	53																																											
72	82																																											
<b>Conformity</b>	<input type="checkbox"/> <b>OK</b> <input type="checkbox"/> <b>Fault</b> <input type="checkbox"/> Major <input type="checkbox"/> Minor, define fail reason in comments																																											
<b>Comments</b>	If possible describe if fault can be fixed with software update: <input type="checkbox"/> <b>YES</b> <input type="checkbox"/> <b>NO</b> Describe more specific faults and/or other information																																											
<b>Date</b>			<b>Sign</b>																																									

	<b>Task 2:19 RF Performance – Analog Adjacent Channel</b>		
<b>Section</b>	NorDig Unified 3.3.5.6 and 3.3.5.7		
<b>Requirement</b>	<p>The NorDig IRD shall perform as specified in section 3.3.5.3 with</p> <ol style="list-style-type: none"> <li>c) Digital signals at 0dBc in the adjacent channels.</li> <li>d) Analogue signals at +10dB in the adjacent channels</li> </ol> <p>The NorDig IRD shall perform as specified in section 3.3.5.3, plus an allowance of 0.2 dB with digital signals at +10dBc in adjacent channels.</p>		
<b>IRD profile(s)</b>	Basic, IRD, DVB-C		

**Test procedure**

**Purpose of test:**

To verify that IRD can operate with required adjacent channels

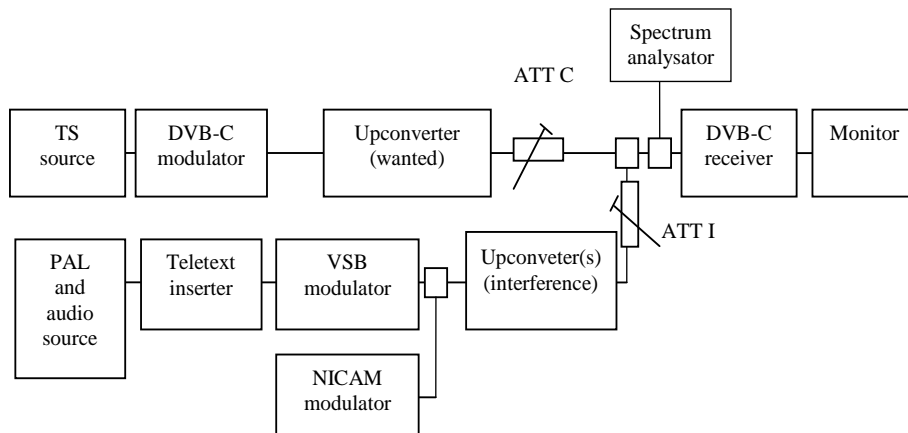

**Test procedure:**

1. Set up the test instruments
2. Use the following PAL signal: Colour bar 75%
3. Insert 12 lines of Teletext.
4. Modulate the FM sound carrier with 1kHz ton to deviation of 50 kHz.
5. Verify that the signal levels of the DVB-C signal and the analogue signal are correct e.g. by using the spectrum analyser.
6. Adjust the level of the FM carrier to -13 dB relative to the vision carrier
7. Adjust the level from NICAM modulator to -20 dB relative to the vision carrier.
8. Use the following DVB-C mode: { 256 QAM, SR=6.952 @ 77 dB $\mu$ V }.
9. Set the upconverter (wanted) for DVB-C carrier to 666.0MHz
10. Set the upconverters (interference) for analog TV carrier to frequency n-1 (658MHz) and n+1 (674 MHz)
11. Set the receiver input levels for the analog TV signals to 77 dB $\mu$ V.
12. Apply Gaussian noise to the wanted signal.
13. Increase the C/N from low value to higher value until the quality measurement procedure 2 (QMP2) fulfills.
14. Fill in the measured C/N value in dB in the measurement record.
15. Repeat the test for the DVB-C modes and signal levels in the measurement record.

**Expected result:**

The measured C/N shall be within required C/N + allowances.



<b>Test result(s)</b>	Wanted signal [dBμV]	Adjacent channels (n-1, n+1) [dBμV]	16 QAM	128 QAM	256 QAM
	47	47			
	77	77			
	47	57			
	72	82			
	Wanted signal [dBμV]	Adjacent channels (n-1, n+1) [dBμV]	64 QAM		
	43	43			
	73	73			
	43	53			
	72	82			
<b>Conformity</b>	<input type="checkbox"/> <b>OK</b> <input type="checkbox"/> <b>Fault</b> <input type="checkbox"/> Major <input type="checkbox"/> Minor, define fail reason in comments				
<b>Comments</b>	If possible describe if fault can be fixed with software update: <input type="checkbox"/> <b>YES</b> <input type="checkbox"/> <b>NO</b> Describe more specific faults and/or other information				
<b>Date</b>			<b>Sign</b>		

	<b>Task 2:20 LO leakage</b>				
<b>Section</b>	NorDig Unified 3.3.6.1				
<b>Requirement</b>	The LO leakage conducted emission (including LO and spurious) from the NorDig IRD, measured at the antenna input connector shall be ≤ 46dBμV over the range 65 to 862MHz				
<b>IRD profile(s)</b>	Basic, IRD, DVB-C				
<b>Test procedure</b>	<p><b>Purpose of test:</b> To verify that IRD fulfils the LO leakage requirements</p> <p><b>Equipment:</b> IRD Under test and spectrum analyzer</p> <p><b>Test procedure:</b> 1. Verify that LO leakage is within requirements</p> <p><b>Expected results:</b> The IRD fulfils the LO leakage requirements,</p>				
<b>Test result(s)</b>					
<b>Conformity</b>	<input type="checkbox"/> <b>OK</b> <input type="checkbox"/> <b>Fault</b> <input type="checkbox"/> Major <input type="checkbox"/> Minor, define fail reason in comments				
<b>Comments</b>	If possible describe if fault can be fixed with software update: <input type="checkbox"/> <b>YES</b> <input type="checkbox"/> <b>NO</b> Describe more specific faults and/or other information				
<b>Date</b>			<b>Sign</b>		

	<b>Task 2:21 Spurious emission</b>				
<b>Section</b>	NorDig Unified 3.3.6.2				



<b>Requirement</b>	<p>The spurious emission from the NorDig IRD to the network, as measured at the antenna input connector, shall be less than 34 dB<math>\mu</math>V over the range 5MHz to 65MHz and less than 30 dB <math>\mu</math>V over 65 to 862 MHz.</p> <p>Generally, spurious emission should not affect the sensitivity of the receiver.</p>	
<b>IRD profile(s)</b>	Basic, IRD, DVB-C	
<b>Test procedure</b>	<p><b>Purpose of test:</b> To verify that IRD fulfils the spurious emission requirements</p> <p><b>Equipment:</b> IRD Under test and spectrum analyzer</p> <p><b>Test procedure:</b></p> <ol style="list-style-type: none"> <li>1. Verify that spurious emission is within requirements or verify the values from manufactures statement.</li> </ol> <p><b>Expected results:</b> The IRD fulfils the speurious emission requirements,</p>	
<b>Test result(s)</b>		
<b>Conformity</b>	<input type="checkbox"/> <b>OK</b> <b>Fault</b> <input type="checkbox"/> Major <input type="checkbox"/> Minor, define fail reason in comments	
<b>Comments</b>	<p>If possible describe if fault can be fixed with software update: <input type="checkbox"/> <b>YES</b> <input type="checkbox"/> <b>NO</b></p> <p>Describe more specific faults and/or other information</p>	
<b>Date</b>		<b>Sign</b>

	<b>Task 2:22 Radiation</b>	
<b>Section</b>	NorDig Unified 3.3.6.3	
<b>Requirement</b>	The radiation from the NorDig IRD shall comply with EN 55013	
<b>IRD profile(s)</b>	Basic, IRD, DVB-C	
<b>Test procedure</b>	<p><b>Purpose of test:</b> To verify that IRD fulfils the radiation requirements</p> <p><b>Equipment:</b> IRD Under test</p> <p><b>Test procedure:</b> Statement from the manufacture shall be included.</p> <p><b>Expected results:</b> The IRD fulfils the radiation requirements,</p>	
<b>Test result(s)</b>		
<b>Conformity</b>	<input type="checkbox"/> <b>OK</b> <b>Fault</b> <input type="checkbox"/> Major <input type="checkbox"/> Minor, define fail reason in comments	
<b>Comments</b>	<p>If possible describe if fault can be fixed with software update: <input type="checkbox"/> <b>YES</b> <input type="checkbox"/> <b>NO</b></p> <p>Describe more specific faults and/or other information</p>	
<b>Date</b>		<b>Sign</b>

## 2.3 Task 3: Terrestrial Tuner and Demodulator

### 2.3.1 Test equipment summary

To configure the minimum test setups described in these test procedures the following functionalities are needed:

Video and audio source (MPEG-2)  
Re-multiplexers  
Broadband Fading simulator  
Noise generator  
DVB-T/T2 Exciter (DVB-T/T2 modulator and up-converter)  
Analog TV RF Exciter with PAL, NICAM and teletext generator.

DVB-T or DVB-T2 receiver with RF input  
Transport stream analyzers  
Power meter with thermo coupled 50ohm and 75ohm power sensor  
Video monitor

Note! The needed instruments may vary depending on the used system and can be purchased from many vendors in a compact all-in-one units. Different test setups are defined in every test case. However, most of the tests can be done using one general test setup.

### 2.3.2 QEF Quality Measurement Methods

The quality limit in this specification is defined as Quasi Error Free (QEF) reception, where QEF means less than one uncorrected error event per hour. The definition of QEF corresponds to BER of  $10^{-11}$  in the TS data at input of the MPEG-2 demultiplexer. In practice, it takes long time to measure such a low BER at TS data level. Therefore, the reception quality can be evaluated either indirectly by

- measuring the BER after Viterbi in DVB-T system, or measuring the BER after LDPC in DVB-T2 system, or
- subjectively inspecting the video screen for a certain period of time and looking for errors in the decoded video.

Direct measurements on the TS data packets are the preferred measurement method, but if this is not possible or acceptable for some reason, the indirect measurements can be used. The indirect measurement methods, which can be used, are objective BER measurements described above or subjective quality measurement.

In the indirect objective method in the DVB-T system, the BER of  $2 \cdot 10^{-4}$  after Viterbi decoder is considered to correspond to an approximation of QEF reception quality for Gaussian type of channels. But for channels interfered by impulse like interference i.e. PAL signals or internal interference, the average BER of  $2 \cdot 10^{-4}$  after Viterbi decoder is not valid due to the fact that the RS decoder is not able to correct the burst of erroneous bytes caused by impulse like interference. Therefore, for impulse like interfered channels, the quality measurements shall be done by using the BER of  $10^{-11}$  measurement method at the TS level at MPEG-2 demultiplexer input or by using the subjective measurement method.

In the indirect objective method in the DVB-T2 system the BER of  $10^{-7}$  after LDPC decoder is considered to correspond to an approximation of QEF reception quality for Gaussian type of channels.

In the indirect subjective measurement method the certain period of time of error free video decoding is considered to correspond to a good reception quality. The specified video test sequence can be any containing movement everywhere, in order to minimise the number of errors not being observed due to error concealment techniques in the receiver. Such a relevant video sequences are e.g. 'Mobile and calendar' and 'Zoneplate'.



The result of the indirect quality measurements may differ. Therefore, the method that shall be used is specified in every test case. However, the reception quality shall be verified by using the subjective measurement method for every test case. The measurement methods (procedures) are defined below.

#### Direct objective quality measurement procedure in DVB-T and DVB-T2 systems

The measurement is performed doing measurements at the transport stream data level. The measurement configuration parameters are chosen like that there is less than one uncorrected error event per hour. This requirement corresponds to BER value  $10^{-11}$  at the TS data level at the input of the MPEG-2 demultiplexer. In addition to the BER measurement, the reception quality shall be verified subjectively.

The performance in every test case can be evaluated by using the direct quality measurement procedure.

#### Indirect subjective quality measurement procedure 1 (QMP1) in DVB-T and DVB-T2 systems

The subjective measurement is performed during **15 seconds**. During this time the decoded video shall be error free. In a case of an error in decoded video, the change to the measurement configuration parameters shall be done. The change of the measurement configuration parameters shall result to an error free decoding of the video where the minimum time between consecutive subjective errors is **15 seconds**. Otherwise, the change of the measurement configuration parameters is repeated until an error free decoding of video is reached at least **15 seconds**.

#### Indirect objective or subjective quality measurement procedure 2 (QMP2) in DVB-T system

The measurement can be performed either by using

5. the embedded BER after Viterbi measurement provided by the receiver ,or
6. watching the decoded video for **60 seconds**.

If the BER after Viterbi measurement is chosen, the value for the approximation of the QEF reception is considered to correspond to the integrated BER after Viterbi decoder value  $2 \cdot 10^{-4}$ . The integrated BER after Viterbi measurement value  $2 \cdot 10^{-4}$  shall be verified that it corresponds an **error free video** decoding. In case of higher BER after Viterbi value than  $2 \cdot 10^{-4}$ , the change to the measurement configuration parameters shall be done. The change of the measurement configuration parameters shall result to a BER after Viterbi which is lower than or equal to  $2 \cdot 10^{-4}$ , Otherwise, the change of the measurement configuration parameters is repeated until a BER after Viterbi value lower than or equal to  $2 \cdot 10^{-4}$  is achieved.

If the **60 seconds** error free decoded video is chosen, during this time the decoded video shall be error free. In a case of an error in decoded video, the change to the measurement configuration parameters shall be done. The change of the measurement configuration parameters shall result to an error free decoding of the video where the minimum time between consecutive subjective errors is **60 seconds**. Otherwise, the change of the measurement configuration parameters is repeated until an error free decoding of video is achieved at least **60 seconds**.

The corresponding measurement value for profile and DVB-T mode shall be achieved from tables below.

Modulation	Code rate	C/N performance (dB)			
		Profile 1 : Gaussian		Profile 2 : 0 dB echo	
		“60 sec error free video”	BER 2E-4 after Viterbi	“60 sec error free video”	BER 2E-4 after Viterbi
QPSK	1/2	3.8	5.1	7.7	8.8
QPSK	2/3	5.6	6.9	11.9	13.7
QPSK	3/4	6.6	7.9	14.1	17.4
QPSK	5/6	7.6	8.9	-	-
QPSK	7/8	8.4	9.7	-	-
16-QAM	1/2	9.5	10.8	12.0	13.3
16-QAM	2/3	11.8	13.1	16.3	17.9
16-QAM	3/4	13.3	14.6	19.0	22.1
16-QAM	5/6	14.3	15.6	-	-
16-QAM	7/8	14.7	16.0	-	-
64-QAM	1/2	15.2	16.5	17.7	19.0
64-QAM	2/3	17.4	18.7	21.8	23.2
64-QAM	3/4	18.9	20.2	24.8	27.6
64-QAM	5/6	20.3	21.6	-	-
64-QAM	7/8	21.2	22.5	-	-

**Table 2.2 Maximum required C/N for “60 seconds error free video” and BER 2E-4 after Viterbi (with 1/4 guard interval and FFT size 8K) for profiles 1 and 2**

		Minimum input level (dBm)											
		Profile 1: Gaussian								Profile 2: 0 dB echo			
Frequency band		VHF Band III		VHF S Band I & II		VHF S Band I & II and UHF S Band III		UHF Band IV&V		VHF Band III		UHF Band IV&V	
		7 MHz signal		7 MHz signal		8 MHz signal		8 MHz signal		7 MHz signal		8 MHz signal	
Modulation	Code Rate	“60 sec error free video”	BER 2E-4 after Viterbi	“60 sec error free video”	BER 2E-4 after Viterbi	“60 sec error free video”	BER 2E-4 after Viterbi	“60 sec error free video”	BER 2E-4 after Viterbi	“60 sec error free video”	BER 2E-4 after Viterbi	“60 sec error free video”	BER 2E-4 after Viterbi”
QPSK	1/2	-94.9	-93.6	-91.9	-90.6	-91.4	-90.1	-94.4	-93.1	-91.1	-89.9	-90.6	-89.4
QPSK	2/3	-93.1	-91.8	-90.1	-88.8	-89.6	-88.3	-92.6	-91.3	-86.8	-85.0	-86.3	-84.5
QPSK	3/4	-92.1	-90.8	-89.1	-87.8	-88.6	-87.3	-91.6	-90.3	-84.6	-81.3	-84.1	-80.8
QPSK	5/6	-91.1	-89.8	-88.1	-86.8	-87.6	-86.3	-90.6	-89.3	-	-	-	-
QPSK	7/8	-90.3	-89.0	-87.3	-86.0	-86.8	-85.5	-89.8	-88.5	-	-	-	-
16-QAM	1/2	-89.2	-87.9	-86.2	-84.9	-85.7	-84.4	-88.7	-87.4	-86.6	-85.4	-86.1	-84.9
16-QAM	2/3	-86.9	-85.6	-83.9	-82.6	-83.4	-82.1	-86.4	-85.1	-82.4	-80.8	-81.9	-80.3
16-QAM	3/4	-85.4	-84.1	-82.4	-81.1	-81.9	-80.6	-84.9	-83.6	-79.7	-76.6	-79.2	-76.1
16-QAM	5/6	-84.4	-83.1	-81.4	-80.1	-80.9	-79.6	-83.9	-82.6	-	-	-	-
16-QAM	7/8	-84.0	-82.7	-81.0	-79.7	-80.5	-79.2	-83.5	-82.2	-	-	-	-
64-QAM	1/2	-83.5	-82.2	-80.5	-79.2	-80.0	-78.7	-83.0	-81.7	-80.9	-79.7	-80.4	-79.2
64-QAM	2/3	-81.3	-80.0	-78.3	-77.0	-77.8	-76.5	-80.8	-79.5	-76.9	-75.5	-76.4	-75.0
64-QAM	3/4	-79.8	-78.5	-76.8	-75.5	-76.3	-75.0	-79.3	-78.0	-73.9	-71.1	-73.4	-70.6
64-QAM	5/6	-78.4	-77.1	-75.4	-74.1	-74.9	-73.6	-77.9	-76.6	-	-	-	-
64-QAM	7/8	-77.5	-76.2	-74.5	-73.2	-74.0	-72.7	-77.0	-75.7	-	-	-	-

**Table 2.3 Minimum signal input levels (Pmin) for “60 seconds error free video” and BER 2E-4 after Viterbi (with 1/4 guard interval and FFT size 8K) for profiles 1 and 2.**

Indirect objective or subjective quality measurement procedure 2 (QMP2) in DVB-T2 system

The measurement can be performed either by using

3. the embedded BER after LDPC measurement provided by the receiver, or
4. watching the decoded video for **30 seconds**.

If the BER after LDPC measurement is chosen, the value for the approximation of the QEF reception is considered to correspond to the integrated BER after LDPC decoder value  $10^{-7}$ . In case of higher BER after LDPC value than  $10^{-7}$ , the change to the measurement configuration parameters shall be done. The change of the measurement configuration parameters shall result to a BER after LDPC which is lower than or equal to  $10^{-7}$ . Otherwise, the change of the measurement configuration parameters is repeated until the BER after LDPC value lower than or equal to  $10^{-7}$  is achieved. That reception shall be verified that it corresponds an **error free video** decoding.

If the **30 seconds** error free decoded video is chosen, during this time the decoded video shall be error free. In a case of an error in decoded video, the change to the measurement configuration parameters shall be done. The change of the measurement configuration parameters shall result to an error free decoding of the video where the minimum time between consecutive subjective errors is **30 seconds**. Otherwise, the change of the measurement configuration parameters is repeated until an error free decoding of video is achieved at least **30 seconds**.

Due to the nature of the DVB-T2 system forward error correction schemes the difference for the 30 seconds error free video and BER  $10^{-7}$  after LDPC is very low. For practical testing the performance values are equal for both quality levels.

The corresponding measurement value for profile and DVB-T2 mode shall be achieved from tables below.

Modulation	Code rate	C/N performance (dB) for PP2			
		Profile 1 : Gaussian		Profile 2 : 0 dB echo	
		“30 sec error free video”	BER 1E-7 after LDPC	“30 sec error free video”	BER 1E-7 after LDPC
QPSK	1/2	3.5	3.5	5.2	5.2
QPSK	3/5	4.7	4.7	6.8	6.8
QPSK	2/3	5.6	5.6	8.4	8.4
QPSK	3/4	6.6	6.6	9.8	9.8
QPSK	4/5	7.2	7.2	-	-
QPSK	5/6	7.7	7.7	-	-
16-QAM	1/2	8.7	8.7	10.9	10.9
16-QAM	3/5	10.1	10.1	12.7	12.7
16-QAM	2/3	11.4	11.4	14.3	14.3
16-QAM	3/4	12.5	12.5	16.3	16.3
16-QAM	4/5	13.3	13.3	-	-
16-QAM	5/6	13.8	13.8	-	-
64-QAM	1/2	13.0	13.0	16.0	16.0
64-QAM	3/5	14.8	14.8	18.0	18.0
64-QAM	2/3	16.2	16.2	19.7	19.7
64-QAM	3/4	17.7	17.7	22.0	22.0
64-QAM	4/5	18.7	18.7	-	-
64-QAM	5/6	19.4	19.4	-	-
256-QAM	1/2	17.0	17.0	20.6	20.6
256-QAM	3/5	19.4	19.4	23.1	23.1
256-QAM	2/3	20.8	20.8	25.1	25.1
256-QAM	3/4	22.9	22.9	27.9	27.9
256-QAM	4/5	24.3	24.3	-	-
256-QAM	5/6	25.1	25.1	-	-

**Table 2.4**Maximum required C/N for “30 seconds error free video” and BER 1E-7 after LDPC for PP2 and for any allowed combination of guard interval, signal bandwidth, FFT size and carrier mode.

Modulation	Code rate	C/N performance (dB) for PP4			
		Profile 1 : Gaussian		Profile 2 : 0 dB echo	
		“30 sec error free video”	BER 1E-7 after LDPC	“30 sec error free video”	BER 1E-7 after LDPC
QPSK	1/2	3.1	3.1	4.8	4.8
QPSK	3/5	4.3	4.3	6.4	6.4
QPSK	2/3	5.2	5.2	8.0	8.0
QPSK	3/4	6.2	6.2	9.4	9.4
QPSK	4/5	6.8	6.8	-	-
QPSK	5/6	7.3	7.3	-	-
16-QAM	1/2	8.3	8.3	10.5	10.5
16-QAM	3/5	9.7	9.7	12.3	12.3
16-QAM	2/3	11.0	11.0	13.9	13.9
16-QAM	3/4	12.1	12.1	15.8	15.8
16-QAM	4/5	12.9	12.9	-	-
16-QAM	5/6	13.4	13.4	-	-
64-QAM	1/2	12.6	12.6	15.5	15.5
64-QAM	3/5	14.4	14.4	17.6	17.6
64-QAM	2/3	15.7	15.7	19.2	19.2
64-QAM	3/4	17.3	17.3	21.5	21.5
64-QAM	4/5	18.3	18.3	-	-
64-QAM	5/6	18.9	18.9	-	-
256-QAM	1/2	16.5	16.5	20.2	20.2
256-QAM	3/5	18.9	18.9	22.6	22.6
256-QAM	2/3	20.4	20.4	24.6	24.6
256-QAM	3/4	22.4	22.4	27.4	27.4
256-QAM	4/5	23.8	23.8	-	-
256-QAM	5/6	24.6	24.6	-	-

**Table 2.5**Maximum required C/N for “30 seconds error free video” and BER 1E-7 after LDPC for PP4 and for any allowed combination of guard interval, signal bandwidth, FFT size and carrier mode.

Modulation	Code rate	C/N performance (dB) for PP6			
		Profile 1 : Gaussian		Profile 2 : 0 dB echo	
		“30 sec error free video”	BER 1E-7 after LDPC	“30 sec error free video”	BER 1E-7 after LDPC
QPSK	1/2	2.6	2.6	4.3	4.3
QPSK	3/5	3.8	3.8	5.9	5.9
QPSK	2/3	4.7	4.7	7.5	7.5
QPSK	3/4	5.7	5.7	8.9	8.9
QPSK	4/5	6.3	6.3	-	-
QPSK	5/6	6.8	6.8	-	-
16-QAM	1/2	7.8	7.8	10.0	10.0
16-QAM	3/5	9.2	9.2	11.8	11.8
16-QAM	2/3	10.5	10.5	13.4	13.4
16-QAM	3/4	11.6	11.6	15.4	15.4
16-QAM	4/5	12.4	12.4	-	-
16-QAM	5/6	12.9	12.9	-	-
64-QAM	1/2	12.1	12.1	15.0	15.0
64-QAM	3/5	13.9	13.9	17.1	17.1
64-QAM	2/3	15.3	15.3	18.7	18.7
64-QAM	3/4	16.8	16.8	21.0	21.0
64-QAM	4/5	17.8	17.8	-	-
64-QAM	5/6	18.4	18.4	-	-
256-QAM	1/2	16.1	16.1	19.7	19.7
256-QAM	3/5	18.4	18.4	22.1	22.1
256-QAM	2/3	19.9	19.9	24.1	24.1
256-QAM	3/4	21.9	21.9	26.8	26.8
256-QAM	4/5	23.3	23.3	-	-
256-QAM	5/6	24.1	24.1	-	-

**Table 2.6**Maximum required C/N for “30 seconds error free video” and BER 1E-7 after LDPC for PP6 and for any allowed combination of guard interval, signal bandwidth, FFT size and carrier mode.

Modulation	Code rate	C/N performance (dB) for PP7			
		Profile 1 : Gaussian		Profile 2 : 0 dB echo	
		“30 sec error free video”	BER 1E-7 after LDPC	“30 sec error free video”	BER 1E-7 after LDPC
QPSK	1/2	2.4	2.4	4.1	4.1
QPSK	3/5	3.6	3.6	5.7	5.7
QPSK	2/3	4.5	4.5	7.3	7.3
QPSK	3/4	5.5	5.5	8.7	8.7
QPSK	4/5	6.1	6.1	-	-
QPSK	5/6	6.6	6.6	-	-
16-QAM	1/2	7.6	7.6	9.9	9.9
16-QAM	3/5	9.0	9.0	11.7	11.7
16-QAM	2/3	10.4	10.4	13.3	13.3
16-QAM	3/4	11.5	11.5	15.2	15.2
16-QAM	4/5	12.3	12.3	-	-
16-QAM	5/6	12.8	12.8	-	-
64-QAM	1/2	12.0	12.0	14.9	14.9
64-QAM	3/5	13.8	13.8	16.9	16.9
64-QAM	2/3	15.1	15.1	18.6	18.6
64-QAM	3/4	16.6	16.6	-	-
64-QAM	4/5	17.7	17.7	-	-
64-QAM	5/6	18.3	18.3	24.3	24.3
256-QAM	1/2	15.9	15.9	19.5	19.5
256-QAM	3/5	18.3	18.3	22.0	22.0
256-QAM	2/3	19.7	19.7	23.9	23.9
256-QAM	3/4	21.7	21.7	26.6	26.6
256-QAM	4/5	23.2	23.2	-	-
256-QAM	5/6	23.9	23.9	-	-

**Table 2.7**Maximum required C/N for “30 seconds error free video” and BER 1E-7 after LDPC for PP7 and for any allowed combination of guard interval, signal bandwidth, FFT size and carrier mode.



		Minimum input level (dBm) for PP2															
		Profile 1: Gaussian										Profile 2: 0 dB echo					
Frequency band		VHF Band III				VHF S Band I & II		VHF S Band I & II and UHF S Band III		UHF Band IV&V		VHF Band III				UHF Band IV&V	
		1.7 MHz signal		7 MHz signal		7 MHz signal		8 MHz signal		8 MHz signal		1.7 MHz signal		7 MHz signal		8 MHz signal	
Modulation	Code Rate	“30 sec error free video”	BER 1E-7 after LDPC	“30 sec error free video”	BER 1E-7 after LDPC	“30 sec error free video”	BER 1E-7 after LDPC	“30 sec error free video”	BER 1E-7 after LDPC	“30 sec error free video”	BER 1E-7 after LDPC	“30 sec error free video”	BER 1E-7 after LDPC	“30 sec error free video”	BER 1E-7 after LDPC	“30 sec error free video”	BER 1E-7 after LDPC
QPSK	1/2	-101.6	-101.6	-96.2	-96.2	-92.2	-92.2	-91.6	-91.6	-95.6	-95.6	-99.9	-99.9	-94.5	-94.5	-93.9	-93.9
QPSK	3/5	-100.4	-100.4	-95.0	-95.0	-91.0	-91.0	-90.4	-90.4	-94.4	-94.4	-98.3	-98.3	-92.9	-92.9	-92.3	-92.3
QPSK	2/3	-99.5	-99.5	-94.1	-94.1	-90.1	-90.1	-89.5	-89.5	-93.5	-93.5	-96.7	-96.7	-91.3	-91.3	-90.7	-90.7
QPSK	3/4	-98.5	-98.5	-93.1	-93.1	-89.1	-89.1	-88.5	-88.5	-92.5	-92.5	-95.3	-95.3	-89.9	-89.9	-89.3	-89.3
QPSK	4/5	-97.9	-97.9	-92.5	-92.5	-88.5	-88.5	-87.9	-87.9	-91.9	-91.9	-94.2	-94.2	-88.8	-88.8	-88.2	-88.2
QPSK	5/6	-97.4	-97.4	-92.0	-92.0	-88.0	-88.0	-87.4	-87.4	-91.4	-91.4	-93.1	-93.1	-87.7	-87.7	-87.1	-87.1
16-QAM	1/2	-96.4	-96.4	-91.0	-91.0	-87.0	-87.0	-86.4	-86.4	-90.4	-90.4	-94.2	-94.2	-88.8	-88.8	-88.2	-88.2
16-QAM	3/5	-95.0	-95.0	-89.6	-89.6	-85.6	-85.6	-85.0	-85.0	-89.0	-89.0	-92.4	-92.4	-87.0	-87.0	-86.4	-86.4
16-QAM	2/3	-93.7	-93.7	-88.3	-88.3	-84.3	-84.3	-83.7	-83.7	-87.7	-87.7	-90.8	-90.8	-85.4	-85.4	-84.8	-84.8
16-QAM	3/4	-92.6	-92.6	-87.2	-87.2	-83.2	-83.2	-82.6	-82.6	-86.6	-86.6	-88.8	-88.8	-83.4	-83.4	-82.8	-82.8
16-QAM	4/5	-91.8	-91.8	-86.4	-86.4	-82.4	-82.4	-81.8	-81.8	-85.8	-85.8	-87.3	-87.3	-81.9	-81.9	-81.3	-81.3
16-QAM	5/6	-91.3	-91.3	-85.9	-85.9	-81.9	-81.9	-81.3	-81.3	-85.3	-85.3	-86.2	-86.2	-80.8	-80.8	-80.2	-80.2
64-QAM	1/2	-92.1	-92.1	-86.7	-86.7	-82.7	-82.7	-82.1	-82.1	-86.1	-86.1	-89.1	-89.1	-83.7	-83.7	-83.1	-83.1
64-QAM	3/5	-90.3	-90.3	-84.9	-84.9	-80.9	-80.9	-80.3	-80.3	-84.3	-84.3	-87.1	-87.1	-81.7	-81.7	-81.1	-81.1
64-QAM	2/3	-88.9	-88.9	-83.5	-83.5	-79.5	-79.5	-78.9	-78.9	-82.9	-82.9	-85.4	-85.4	-80.0	-80.0	-79.4	-79.4
64-QAM	3/4	-87.4	-87.4	-82.0	-82.0	-78.0	-78.0	-77.4	-77.4	-81.4	-81.4	-83.1	-83.1	-77.7	-77.7	-77.1	-77.1
64-QAM	4/5	-86.4	-86.4	-81.0	-81.0	-77.0	-77.0	-76.4	-76.4	-80.4	-80.4	-81.1	-81.1	-75.7	-75.7	-75.1	-75.1
64-QAM	5/6	-85.7	-85.7	-80.3	-80.3	-76.3	-76.3	-75.7	-75.7	-79.7	-79.7	-79.6	-79.6	-74.2	-74.2	-73.6	-73.6
256-QAM	1/2	-88.1	-88.1	-82.7	-82.7	-78.7	-78.7	-78.1	-78.1	-82.1	-82.1	-84.5	-84.5	-79.1	-79.1	-78.5	-78.5
256-QAM	3/5	-85.7	-85.7	-80.3	-80.3	-76.3	-76.3	-75.7	-75.7	-79.7	-79.7	-82.0	-82.0	-76.6	-76.6	-76.0	-76.0
256-QAM	2/3	-84.3	-84.3	-78.9	-78.9	-74.9	-74.9	-74.3	-74.3	-78.3	-78.3	-80.0	-80.0	-74.6	-74.6	-74.0	-74.0
256-QAM	3/4	-82.2	-82.2	-76.8	-76.8	-72.8	-72.8	-72.2	-72.2	-76.2	-76.2	-77.2	-77.2	-71.8	-71.8	-71.2	-71.2
256-QAM	4/5	-80.8	-80.8	-75.4	-75.4	-71.4	-71.4	-70.8	-70.8	-74.8	-74.8	-74.3	-74.3	-68.9	-68.9	-68.3	-68.3
256-QAM	5/6	-80.0	-80.0	-74.6	-74.6	-70.6	-70.6	-70.0	-70.0	-74.0	-74.0	-71.5	-71.5	-66.1	-66.1	-65.5	-65.5

Table 2.8 Minimum DVB-T2 signal input levels (Pmin) for “30 seconds error free video” and BER 1E-7 after LDPC for PP2 and for any allowed combination of guard interval, signal bandwidth, FFT size and extended carrier mode. Values are equal for normal carrier mode except for 8MHz signal BW where 0.1dB is subtracted. Before 1.1.2012 the values for non-S-band channels may be increased with 1 dB, excluding 1.7MHz bandwidth columns, due to a 1 dB relaxation in noise figure.

Frequency band		Minimum input level (dBm) for PP4															
		Profile 1: Gaussian										Profile 2: 0 dB echo					
		VHF Band III		VHF S Band I & II		VHF S Band I & II and UHF S Band III		UHF Band IV&V		VHF Band III		UHF Band IV&V					
Modulation	Code Rate	1.7 MHz signal		7 MHz signal		7 MHz signal		8 MHz signal		8 MHz signal		1.7 MHz signal		7 MHz signal		8 MHz signal	
		“30 sec error free video”	BER 1E-7 after LDPC	“30 sec error free video”	BER 1E-7 after LDPC	“30 sec error free video”	BER 1E-7 after LDPC	“30 sec error free video”	BER 1E-7 after LDPC	“30 sec error free video”	BER 1E-7 after LDPC	“30 sec error free video”	BER 1E-7 after LDPC	“30 sec error free video”	BER 1E-7 after LDPC	“30 sec error free video”	BER 1E-7 after LDPC
QPSK	1/2	-102.0	-102.0	-96.6	-96.6	-92.6	-92.6	-92.0	-92.0	-96.0	-96.0	-100.3	-100.3	-94.9	-94.9	-94.3	-94.3
QPSK	3/5	-100.8	-100.8	-95.4	-95.4	-91.4	-91.4	-90.8	-90.8	-94.8	-94.8	-98.7	-98.7	-93.3	-93.3	-92.7	-92.7
QPSK	2/3	-99.9	-99.9	-94.5	-94.5	-90.5	-90.5	-89.9	-89.9	-93.9	-93.9	-97.1	-97.1	-91.7	-91.7	-91.1	-91.1
QPSK	3/4	-98.9	-98.9	-93.5	-93.5	-89.5	-89.5	-88.9	-88.9	-92.9	-92.9	-95.7	-95.7	-90.3	-90.3	-89.7	-89.7
QPSK	4/5	-98.3	-98.3	-92.9	-92.9	-88.9	-88.9	-88.3	-88.3	-92.3	-92.3	-94.6	-94.6	-89.2	-89.2	-88.6	-88.6
QPSK	5/6	-97.8	-97.8	-92.4	-92.4	-88.4	-88.4	-87.8	-87.8	-91.8	-91.8	-93.5	-93.5	-88.1	-88.1	-87.5	-87.5
16-QAM	1/2	-96.8	-96.8	-91.4	-91.4	-87.4	-87.4	-86.8	-86.8	-90.8	-90.8	-94.6	-94.6	-89.2	-89.2	-88.6	-88.6
16-QAM	3/5	-95.4	-95.4	-90.0	-90.0	-86.0	-86.0	-85.4	-85.4	-89.4	-89.4	-92.8	-92.8	-87.4	-87.4	-86.8	-86.8
16-QAM	2/3	-94.1	-94.1	-88.7	-88.7	-84.7	-84.7	-84.1	-84.1	-88.1	-88.1	-91.2	-91.2	-85.8	-85.8	-85.2	-85.2
16-QAM	3/4	-93.0	-93.0	-87.6	-87.6	-83.6	-83.6	-83.0	-83.0	-87.0	-87.0	-89.3	-89.3	-83.9	-83.9	-83.3	-83.3
16-QAM	4/5	-92.2	-92.2	-86.8	-86.8	-82.8	-82.8	-82.2	-82.2	-86.2	-86.2	-87.7	-87.7	-82.3	-82.3	-81.7	-81.7
16-QAM	5/6	-91.7	-91.7	-86.3	-86.3	-82.3	-82.3	-81.7	-81.7	-85.7	-85.7	-86.6	-86.6	-81.2	-81.2	-80.6	-80.6
64-QAM	1/2	-92.5	-92.5	-87.1	-87.1	-83.1	-83.1	-82.5	-82.5	-86.5	-86.5	-89.6	-89.6	-84.2	-84.2	-83.6	-83.6
64-QAM	3/5	-90.7	-90.7	-85.3	-85.3	-81.3	-81.3	-80.7	-80.7	-84.7	-84.7	-87.5	-87.5	-82.1	-82.1	-81.5	-81.5
64-QAM	2/3	-89.4	-89.4	-84.0	-84.0	-80.0	-80.0	-79.4	-79.4	-83.4	-83.4	-85.9	-85.9	-80.5	-80.5	-79.9	-79.9
64-QAM	3/4	-87.8	-87.8	-82.4	-82.4	-78.4	-78.4	-77.8	-77.8	-81.8	-81.8	-83.6	-83.6	-78.2	-78.2	-77.6	-77.6
64-QAM	4/5	-86.8	-86.8	-81.4	-81.4	-77.4	-77.4	-76.8	-76.8	-80.8	-80.8	-81.6	-81.6	-76.2	-76.2	-75.6	-75.6
64-QAM	5/6	-86.2	-86.2	-80.8	-80.8	-76.8	-76.8	-76.2	-76.2	-80.2	-80.2	-80.1	-80.1	-74.7	-74.7	-74.1	-74.1
256-QAM	1/2	-88.6	-88.6	-83.2	-83.2	-79.2	-79.2	-78.6	-78.6	-82.6	-82.6	-84.9	-84.9	-79.5	-79.5	-78.9	-78.9
256-QAM	3/5	-86.2	-86.2	-80.8	-80.8	-76.8	-76.8	-76.2	-76.2	-80.2	-80.2	-82.5	-82.5	-77.1	-77.1	-76.5	-76.5
256-QAM	2/3	-84.7	-84.7	-79.3	-79.3	-75.3	-75.3	-74.7	-74.7	-78.7	-78.7	-80.5	-80.5	-75.1	-75.1	-74.5	-74.5
256-QAM	3/4	-82.7	-82.7	-77.3	-77.3	-73.3	-73.3	-72.7	-72.7	-76.7	-76.7	-77.7	-77.7	-72.3	-72.3	-71.7	-71.7
256-QAM	4/5	-81.3	-81.3	-75.9	-75.9	-71.9	-71.9	-71.3	-71.3	-75.3	-75.3	-74.9	-74.9	-69.5	-69.5	-68.9	-68.9
256-QAM	5/6	-80.5	-80.5	-75.1	-75.1	-71.1	-71.1	-70.5	-70.5	-74.5	-74.5	-72.4	-72.4	-67.0	-67.0	-66.4	-66.4

**Table 2.9** Minimum DVB-T2 signal input levels (Pmin) for “30 seconds error free video” and BER 1E-7 after LDPC for PP4 and for any allowed combination of guard interval, FFT size and extended carrier mode. Values are equal for normal carrier mode except for 8MHz signal BW where 0.1dB is subtracted. Before 1.1.2012 the values for non-S-band channels may be increased with 1 dB, excluding 1.7MHz bandwidth columns, due to a 1 dB relaxation in noise figure.

Frequency band		Minimum input level (dBm) for PP6															
		Profile 1: Gaussian										Profile 2: 0 dB echo					
		VHF Band III				VHF S Band I & II		VHF S Band I & II and UHF S Band III		UHF Band IV&V		VHF Band III			UHF Band IV&V		
Modulation	Code Rate	1.7 MHz signal		7 MHz signal		7 MHz signal		8 MHz signal		8 MHz signal		1.7 MHz signal		7 MHz signal		8 MHz signal	
		“30 sec error free video”	BER 1E-7 after LDPC	“30 sec error free video”	BER 1E-7 after LDPC	“30 sec error free video”	BER 1E-7 after LDPC	“30 sec error free video”	BER 1E-7 after LDPC	“30 sec error free video”	BER 1E-7 after LDPC	“30 sec error free video”	BER 1E-7 after LDPC	“30 sec error free video”	BER 1E-7 after LDPC	“30 sec error free video”	BER 1E-7 after LDPC
QPSK	1/2	-102.5	-102.5	-97.1	-97.1	-93.1	-93.1	-92.5	-92.5	-96.5	-96.5	-100.8	-100.8	-95.4	-95.4	-94.8	-94.8
QPSK	3/5	-101.3	-101.3	-95.9	-95.9	-91.9	-91.9	-91.3	-91.3	-95.3	-95.3	-99.2	-99.2	-93.8	-93.8	-93.2	-93.2
QPSK	2/3	-100.4	-100.4	-95.0	-95.0	-91.0	-91.0	-90.4	-90.4	-94.4	-94.4	-97.6	-97.6	-92.2	-92.2	-91.6	-91.6
QPSK	3/4	-99.4	-99.4	-94.0	-94.0	-90.0	-90.0	-89.4	-89.4	-93.4	-93.4	-96.2	-96.2	-90.8	-90.8	-90.2	-90.2
QPSK	4/5	-98.8	-98.8	-93.4	-93.4	-89.4	-89.4	-88.8	-88.8	-92.8	-92.8	-95.1	-95.1	-89.7	-89.7	-89.1	-89.1
QPSK	5/6	-98.3	-98.3	-92.9	-92.9	-88.9	-88.9	-88.3	-88.3	-92.3	-92.3	-94.0	-94.0	-88.6	-88.6	-88.0	-88.0
16-QAM	1/2	-97.3	-97.3	-91.9	-91.9	-87.9	-87.9	-87.3	-87.3	-91.3	-91.3	-95.1	-95.1	-89.7	-89.7	-89.1	-89.1
16-QAM	3/5	-95.9	-95.9	-90.5	-90.5	-86.5	-86.5	-85.9	-85.9	-89.9	-89.9	-93.3	-93.3	-87.9	-87.9	-87.3	-87.3
16-QAM	2/3	-94.6	-94.6	-89.2	-89.2	-85.2	-85.2	-84.6	-84.6	-88.6	-88.6	-91.7	-91.7	-86.3	-86.3	-85.7	-85.7
16-QAM	3/4	-93.5	-93.5	-88.1	-88.1	-84.1	-84.1	-83.5	-83.5	-87.5	-87.5	-89.7	-89.7	-84.3	-84.3	-83.7	-83.7
16-QAM	4/5	-92.7	-92.7	-87.3	-87.3	-83.3	-83.3	-82.7	-82.7	-86.7	-86.7	-88.2	-88.2	-82.8	-82.8	-82.2	-82.2
16-QAM	5/6	-92.2	-92.2	-86.8	-86.8	-82.8	-82.8	-82.2	-82.2	-86.2	-86.2	-87.1	-87.1	-81.7	-81.7	-81.1	-81.1
64-QAM	1/2	-93.0	-93.0	-87.6	-87.6	-83.6	-83.6	-83.0	-83.0	-87.0	-87.0	-90.1	-90.1	-84.7	-84.7	-84.1	-84.1
64-QAM	3/5	-91.2	-91.2	-85.8	-85.8	-81.8	-81.8	-81.2	-81.2	-85.2	-85.2	-88.0	-88.0	-82.6	-82.6	-82.0	-82.0
64-QAM	2/3	-89.8	-89.8	-84.4	-84.4	-80.4	-80.4	-79.8	-79.8	-83.8	-83.8	-86.4	-86.4	-81.0	-81.0	-80.4	-80.4
64-QAM	3/4	-88.3	-88.3	-82.9	-82.9	-78.9	-78.9	-78.3	-78.3	-82.3	-82.3	-84.1	-84.1	-78.7	-78.7	-78.1	-78.1
64-QAM	4/5	-87.3	-87.3	-81.9	-81.9	-77.9	-77.9	-77.3	-77.3	-81.3	-81.3	-82.1	-82.1	-76.7	-76.7	-76.1	-76.1
64-QAM	5/6	-86.7	-86.7	-81.3	-81.3	-77.3	-77.3	-76.7	-76.7	-80.7	-80.7	-80.7	-80.7	-75.3	-75.3	-74.7	-74.7
256-QAM	1/2	-89.0	-89.0	-83.6	-83.6	-79.6	-79.6	-79.0	-79.0	-83.0	-83.0	-85.4	-85.4	-80.0	-80.0	-79.4	-79.4
256-QAM	3/5	-86.7	-86.7	-81.3	-81.3	-77.3	-77.3	-76.7	-76.7	-80.7	-80.7	-83.0	-83.0	-77.6	-77.6	-77.0	-77.0
256-QAM	2/3	-85.2	-85.2	-79.8	-79.8	-75.8	-75.8	-75.2	-75.2	-79.2	-79.2	-81.0	-81.0	-75.6	-75.6	-75.0	-75.0
256-QAM	3/4	-83.2	-83.2	-77.8	-77.8	-73.8	-73.8	-73.2	-73.2	-77.2	-77.2	-78.3	-78.3	-72.9	-72.9	-72.3	-72.3
256-QAM	4/5	-81.8	-81.8	-76.4	-76.4	-72.4	-72.4	-71.8	-71.8	-75.8	-75.8	-75.6	-75.6	-70.2	-70.2	-69.6	-69.6
256-QAM	5/6	-81.0	-81.0	-75.6	-75.6	-71.6	-71.6	-71.0	-71.0	-75.0	-75.0	-73.3	-73.3	-67.9	-67.9	-67.3	-67.3

**Table 2.10** Minimum DVB-T2 signal input levels (Pmin) for “30 seconds error free video” and BER 1E-7 after LDPC for PP6 and for any allowed combination of guard interval, FFT size and extended carrier mode. Values are equal for normal carrier mode except for 8MHz signal BW where 0.1dB is subtracted. Before 1.1.2012 the values for non-S-band channels may be increased with 1 dB, excluding 1.7MHz bandwidth columns, due to a 1 dB relaxation in noise figure.

		Minimum input level (dBm) for PP7															
		Profile 1: Gaussian										Profile 2: 0 dB echo					
Frequency band		VHF Band III				VHF S Band I & II		VHF S Band I & II and UHF S Band III		UHF Band IV&V		VHF Band III				UHF Band IV&V	
		1.7 MHz signal		7 MHz signal		7 MHz signal		8 MHz signal		8 MHz signal		1.7 MHz signal		7 MHz signal		8 MHz signal	
Modulation	Code Rate	“30 sec error free video”	BER 1E-7 after LDPC	“30 sec error free video”	BER 1E-7 after LDPC	“30 sec error free video”	BER 1E-7 after LDPC	“30 sec error free video”	BER 1E-7 after LDPC	“30 sec error free video”	BER 1E-7 after LDPC	“30 sec error free video”	BER 1E-7 after LDPC	“30 sec error free video”	BER 1E-7 after LDPC	“30 sec error free video”	BER 1E-7 after LDPC
QPSK	1/2	-102.7	-102.7	-97.3	-97.3	-93.3	-93.3	-92.7	-92.7	-96.7	-96.7	-101.0	-101.0	-95.6	-95.6	-95.0	-95.0
QPSK	3/5	-101.5	-101.5	-96.1	-96.1	-92.1	-92.1	-91.5	-91.5	-95.5	-95.5	-99.4	-99.4	-94.0	-94.0	-93.4	-93.4
QPSK	2/3	-100.6	-100.6	-95.2	-95.2	-91.2	-91.2	-90.6	-90.6	-94.6	-94.6	-97.8	-97.8	-92.4	-92.4	-91.8	-91.8
QPSK	3/4	-99.6	-99.6	-94.2	-94.2	-90.2	-90.2	-89.6	-89.6	-93.6	-93.6	-96.4	-96.4	-91.0	-91.0	-90.4	-90.4
QPSK	4/5	-99.0	-99.0	-93.6	-93.6	-89.6	-89.6	-89.0	-89.0	-93.0	-93.0	-95.2	-95.2	-89.8	-89.8	-89.2	-89.2
QPSK	5/6	-98.5	-98.5	-93.1	-93.1	-89.1	-89.1	-88.5	-88.5	-92.5	-92.5	-94.1	-94.1	-88.7	-88.7	-88.1	-88.1
16-QAM	1/2	-97.5	-97.5	-92.1	-92.1	-88.1	-88.1	-87.5	-87.5	-91.5	-91.5	-95.2	-95.2	-89.8	-89.8	-89.2	-89.2
16-QAM	3/5	-96.1	-96.1	-90.7	-90.7	-86.7	-86.7	-86.1	-86.1	-90.1	-90.1	-93.4	-93.4	-88.0	-88.0	-87.4	-87.4
16-QAM	2/3	-94.7	-94.7	-89.3	-89.3	-85.3	-85.3	-84.7	-84.7	-88.7	-88.7	-91.8	-91.8	-86.4	-86.4	-85.8	-85.8
16-QAM	3/4	-93.6	-93.6	-88.2	-88.2	-84.2	-84.2	-83.6	-83.6	-87.6	-87.6	-89.9	-89.9	-84.5	-84.5	-83.9	-83.9
16-QAM	4/5	-92.8	-92.8	-87.4	-87.4	-83.4	-83.4	-82.8	-82.8	-86.8	-86.8	-88.4	-88.4	-83.0	-83.0	-82.4	-82.4
16-QAM	5/6	-92.3	-92.3	-86.9	-86.9	-82.9	-82.9	-82.3	-82.3	-86.3	-86.3	-87.2	-87.2	-81.8	-81.8	-81.2	-81.2
64-QAM	1/2	-93.1	-93.1	-87.7	-87.7	-83.7	-83.7	-83.1	-83.1	-87.1	-87.1	-90.2	-90.2	-84.8	-84.8	-84.2	-84.2
64-QAM	3/5	-91.3	-91.3	-85.9	-85.9	-81.9	-81.9	-81.3	-81.3	-85.3	-85.3	-88.2	-88.2	-82.8	-82.8	-82.2	-82.2
64-QAM	2/3	-90.0	-90.0	-84.6	-84.6	-80.6	-80.6	-80.0	-80.0	-84.0	-84.0	-86.5	-86.5	-81.1	-81.1	-80.5	-80.5
64-QAM	3/4	-88.5	-88.5	-83.1	-83.1	-79.1	-79.1	-78.5	-78.5	-82.5	-82.5	-84.2	-84.2	-78.8	-78.8	-78.2	-78.2
64-QAM	4/5	-87.4	-87.4	-82.0	-82.0	-78.0	-78.0	-77.4	-77.4	-81.4	-81.4	-82.3	-82.3	-76.9	-76.9	-76.3	-76.3
64-QAM	5/6	-86.8	-86.8	-81.4	-81.4	-77.4	-77.4	-76.8	-76.8	-80.8	-80.8	-80.8	-80.8	-75.4	-75.4	-74.8	-74.8
256-QAM	1/2	-89.2	-89.2	-83.8	-83.8	-79.8	-79.8	-79.2	-79.2	-83.2	-83.2	-85.6	-85.6	-80.2	-80.2	-79.6	-79.6
256-QAM	3/5	-86.8	-86.8	-81.4	-81.4	-77.4	-77.4	-76.8	-76.8	-80.8	-80.8	-83.1	-83.1	-77.7	-77.7	-77.1	-77.1
256-QAM	2/3	-85.4	-85.4	-80.0	-80.0	-76.0	-76.0	-75.4	-75.4	-79.4	-79.4	-81.2	-81.2	-75.8	-75.8	-75.2	-75.2
256-QAM	3/4	-83.4	-83.4	-78.0	-78.0	-74.0	-74.0	-73.4	-73.4	-77.4	-77.4	-78.5	-78.5	-73.1	-73.1	-72.5	-72.5
256-QAM	4/5	-81.9	-81.9	-76.5	-76.5	-72.5	-72.5	-71.9	-71.9	-75.9	-75.9	-75.8	-75.8	-70.4	-70.4	-69.8	-69.8
256-QAM	5/6	-81.2	-81.2	-75.8	-75.8	-71.8	-71.8	-71.2	-71.2	-75.2	-75.2	-73.5	-73.5	-68.1	-68.1	-67.5	-67.5

**Table 2.11** Minimum DVB-T2 signal input levels (Pmin) for “30 seconds error free video” and BER 1E-7 after LDPC for PP7 and for any allowed combination of guard interval, FFT size and extended carrier mode. Values are equal for normal carrier mode except for 8MHz signal BW where 0.1dB is subtracted. Before 1.1.2012 the values for non-S-band channels may be increased with 1 dB, excluding 1.7MHz bandwidth columns, due to a 1 dB relaxation in noise figure.

### 2.3.3 Bitrates

The different DVB-T/T2 modes define different bitrates for the transport stream. The following table defines the bitrates for the transport stream in Mbit/s. For DVB-T2 bit rate calculation combination highest time interleaving depth and highest number of symbols per frame resulting highest bit rate is used.

8MHz, 2k / 8k					
Modulation	FEC	Tg=1/32	Tg=1/16	Tg=1/8	Tg=1/4
QPSK	1/2	6.032086	5.854671	5.529412	4.976471
QPSK	2/3	8.042781	7.806228	7.372549	6.635294
QPSK	3/4	9.048128	8.782007	8.294118	7.464706
QPSK	5/6	10.053476	9.757785	9.215686	8.294118
QPSK	7/8	10.556150	10.245675	9.676471	8.708824
16QAM	1/2	12.064171	11.709343	11.058824	9.952941
16QAM	2/3	16.085561	15.612457	14.745098	13.270588
16QAM	3/4	18.096257	17.564014	16.588235	14.929412
16QAM	5/6	20.106952	19.515571	18.431373	16.588235
16QAM	7/8	21.112299	20.491349	19.352941	17.417647
64QAM	1/2	18.096257	17.564014	16.588235	14.929412
64QAM	2/3	24.128342	23.418685	22.117647	19.905882
64QAM	3/4	27.144385	26.346021	24.882353	22.394118
64QAM	5/6	30.160428	29.273356	27.647059	24.882353
64QAM	7/8	31.668449	30.737024	29.029412	26.126471

**Table 2.12 Bitrates for the transport stream in Mbit/s for 8MHz DVB-T signal bandwidth.**

7MHz, 2k / 8k					
Modulation	FEC	Tg=1/32	Tg=1/16	Tg=1/8	Tg=1/4
QPSK	1/2	5.278075	5.122837	4.838235	4.354412
QPSK	2/3	7.037433	6.830450	6.450980	5.805882
QPSK	3/4	7.917112	7.684256	7.257353	6.531618
QPSK	5/6	8.796791	8.538062	8.063725	7.257353
QPSK	7/8	9.236631	8.964965	8.466912	7.620221
16QAM	1/2	10.556150	10.245675	9.676471	8.708824
16QAM	2/3	14.074866	13.660900	12.901961	11.611765
16QAM	3/4	15.834225	15.368512	14.514706	13.063235
16QAM	5/6	17.593583	17.076125	16.127451	14.514706
16QAM	7/8	18.473262	17.929931	16.933824	15.240441
64QAM	1/2	15.834225	15.368512	14.514706	13.063235
64QAM	2/3	21.112299	20.491349	19.352941	17.417647
64QAM	3/4	23.751337	23.052768	21.772059	19.594853
64QAM	5/6	26.390374	25.614187	24.191176	21.772059
64QAM	7/8	27.709893	26.894896	25.400735	22.860662

**Table 2.13 Bitrates for the transport stream in Mbit/s for 7MHz DVB-T signal bandwidth.**

8MHz, 32k extended, L1-ACE & TR PAPR							
Modulation	FEC	PP	Tg=1/128	Tg=1/32	Tg=1/16	Tg=19/256	Tg=1/8
256QAM rotated	3/5	PP4	N/A	33.843523	32.849069	32.491052	N/A
		PP6	N/A	34.520394	N/A	N/A	N/A
256QAM rotated	2/3	PP4	N/A	37.658458	36.551906	-	N/A
		PP6	N/A	38.411627	N/A	N/A	N/A
		PP7	39.8164804	N/A	N/A	N/A	N/A
256QAM rotated	3/4	PP2	N/A	N/A	-	-	37.120437
		PP4	N/A	42.364012	41.119193	-	N/A
		PP7	44.7916868	N/A	N/A	N/A	N/A

**Table 2.14 Bitrates for the transport stream in Mbit/s for 8MHz DVB-T2 signal bandwidth.**

7MHz, 32k normal, L1-ACE & TR PAPR							
Modulation	FEC	PP	Tg=1/128	Tg=1/32	Tg=1/16	Tg=19/256	Tg=1/8
256QAM rotated	3/5	PP2	N/A	N/A	26.870949	-	25.386712
		PP4	N/A	28.975435	28.123999	-	N/A
		PP7	30.527312	N/A	N/A	N/A	N/A
256QAM rotated	2/3	PP2	N/A	N/A	29.899917	-	28.248373
		PP4	N/A	32.241626	31.294213	30.953132	N/A
		PP7	33.968435	N/A	N/A	N/A	N/A
256QAM rotated	3/4	PP2	N/A	N/A	33.636014	-	31.778104
		PP4	N/A	36.270328	35.204533	-	N/A
		PP7	38.212908	N/A	N/A	N/A	N/A

**Table 2.15 Bitrates for the transport stream in Mbit/s for 7MHz DVB-T2 signal bandwidth.**

1.7MHz, 8k normal, L1-ACE & TR PAPR						
Modulation	FEC	PP	Tg=1/128	Tg=1/32	Tg=1/16	Tg=1/8
256QAM rotated	2/3	PP2	N/A	N/A	N/A	6.324006

**Table 2.16 Bitrates for the transport stream in Mbit/s for 1.7MHz DVB-T2 signal bandwidth.**

The video and audio compression technique of the content within transport stream doesn't have any influence to RF performance test results. Therefore, following content compression with given bit rate applies for all tests excluding DVB-T2 receiver buffer model tests where requirement for lower transport stream bit rate is necessary in order to stress the receiver buffer correctly.

Normal test content conditions:

The used video is MPEG-2 elementary stream in resolution 720x576. The video bitrate within transport stream is 4.0 Mbit/s.

The used audio is MPEG-1 elementary stream in stereo mode. The audio bitrate is 128kbit/s per channel.

Test tasks Task 3:41, Task 3:42, Task 3:43 and Task 3:46:

A transport stream bit rate shall be equal or below 3.3 MBit/s. Video and audio content carried within transport stream shall be selected so that transport stream bit rate condition is met.

### 2.3.4 Receiver operability in SFN

The SFN synchronisation of the receiver depends on the echo delay and attenuation level in the SFN. The SFN synchronisation of the receiver may also depend of the state of the receiver. Therefore, it is important to evaluate if the receiver synchronises differently in the following situations:

1. When the receiver is restarted completely (AC cord disconnected).
2. When the receiver is powered on in standby mode. The last good SFN synchronisation parameters can be saved to memory for faster SFN synchronisation leading that the dynamical change of the delay during the receiver is in standby mode gives bad result on power up.
3. During the channel search.
4. Connecting and disconnecting the input RF signal (closing and opening of the RF switch as in test cases). Discontinued input RF signal tests the SFN synchronisation algorithm when the receiver is forced to an unlocked state, e.g. when transmission is discontinued.
5. Zapping between services on different frequencies. Different frequencies have different echo delays and attenuation levels. This corresponds the real reception.
6. During the over-the-air software upgrade. If the demodulator is not correctly controlled during the software download, the SFN synchronisation problems can lead that the software cannot be updated.

Evaluation of the SFN synchronisation can be done e.g. when an echo delay and amplitude level combination is founded to be difficult to synchronise. In that case methods above are tested. Decide which method can be used to evaluate the SFN synchronisation algorithm of the receiver. Check also that all the other methods work. Independently of the state of the receiver all the listed methods above shall work.

The receiver shall detect correct synchronization in SFN, maintain it and provide reception quality at required quality level independently if the received signal changes from bad conditions to good conditions or vice versa. E.g. when testing and finding the required C/N in test cases, the receiver must be able to detect correct synchronization in SFN, maintain it and provide reception quality at defined quality level when C/N value is changed from low (bad reception condition) value to higher (better reception condition) value.

### 2.3.5 0dB echo

The 0 degree channel center shall be used in fading simulator. In this context it means that the carriers from the direct and echo signal are cumulative. See figure below for 0dB 1.95 $\mu$ s echo.

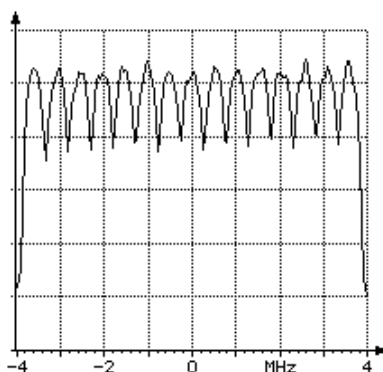

### 2.3.6 Conditions for analogue TV

The level of the analog TV signal is defined to be the power during the sync pulse of the vision carrier. The power of the sync pulse of the vision carrier shall be measured when the video input of the analogue TV modulator is connected to 75ohm load, in other words, there is no modulation in the vision carrier. 10% modulation depth is used for vision carrier.

The level of the FM sound relative to the vision carrier is -13 dB. The frequency of FM sound carrier is +5.5 MHz relative to vision carrier.

The level of the NICAM signal relative to the vision carrier is -20 dB. The frequency of the NICAM carrier is +5.85MHz relative to vision carrier.

It shall be verified that the analog TV signal doesn't have too high out-of-band emissions, which could cause interference to other frequencies.

The equipment used for generation of the analog TV shall be connected to same frequency reference signal as the digital TV equipment.

### **2.3.7 Summary of DVB-T2 modes in DVB-T2 test tasks**

Manufacture shall ensure the functionality of the receiver in all required DVB-T2 parameter settings specified in (1). Also, manufacture shall ensure the performance as required in (1) for the subset of the DVB-T2 modes although in test cases the amount of the DVB-T2 may have been reduced in order to minimise the test time.

Summary of mandatory parameters settings for single and multiple PLP DVB-T2 modes are listed in Table 2.16 and Table 2.17 used in DVB-T2 test tasks. In every test case any deviations to the common parameters are specified.





	NU_S1	NU_S2, NU_S3	NU_S4, NU_S5	NU_S6, NU_S7, NU_S8	NU_S9, NU_S10, NU_S11	NU_S12, NU_S13, NU_S14	NU_S15 ... NU_S26	NU_S27, NU_S28, NU_S29	NU_S30, NU_S31, NU_S32	NU_S33, NU_S34	NU_S35, NU_S36, NU_S37	NU_S38 ... N_S49
PAPR: Number of iterations	10	10	10	10	10	10	10	10	10	10	10	10
Input TS bit rate [MBit/s]	4.5	4.5	4.5	4.5	4.5	4.5	4.5	4.5	4.5	4.5	4.5	4.5
Number of PLPs	1	1	1	1	1	1	1	1	1	1	1	1
PLP id	*)	*)	*)	*)	*)	*)	*)	*)	*)	*)	*)	*)
Group id	*)	*)	*)	*)	*)	*)	*)	*)	*)	*)	*)	*)
PLP type	Data type 1	Data type 1	Data type 1	Data type 1	Data type 1	Data type 1	Data type 1	Data type 1	Data type 1	Data type 1	Data type 1	Data type 1
Constellation rotation	Yes	Yes	Yes	Yes	Yes	Yes	Yes	Yes	Yes	Yes	Yes	Yes
PLP FEC type	64k LDPC	64k LDPC	64k LDPC	64k LDPC	64k LDPC	64k LDPC	64k LDPC	64k LDPC	64k LDPC	64k LDPC	64k LDPC	64k LDPC
FEC Frame length	64800	64800	64800	64800	64800	64800	64800	64800	64800	64800	64800	64800
Baseband Mode	High efficiency mode (HEM)	High efficiency mode (HEM)	High efficiency mode (HEM)	High efficiency mode (HEM)	High efficiency mode (HEM)	High efficiency mode (HEM)	High efficiency mode (HEM)	High efficiency mode (HEM)	High efficiency mode (HEM)	High efficiency mode (HEM)	High efficiency mode (HEM)	High efficiency mode (HEM)
ISSY	Long	Long	Long	Long	Long	Long	Long	Long	Long	Long	Long	Long
In band signaling	Disabled	Disabled	Disabled	Disabled	Disabled	Disabled	Disabled	Disabled	Disabled	Disabled	Disabled	Disabled
Null packet deletion	Enabled	Enabled	Enabled	Disabled	Disabled	Disabled	Disabled	Disabled	Disabled	Disabled	Disabled	Disabled
Time interval blocks per frame	TBD	TBD	TBD	TBD	TBD	TBD	TBD	TBD	TBD	TBD	TBD	TBD
Time interleaver length	3	3	3	3	3	3	3	3	3	3	3	3
Frame interval	1	1	1	1	1	1	1	1	1	1	1	1
Time interleaver type	0	0	0	0	0	0	0	0	0	0	0	0
T2 frames / Interleaver frame	1	1	1	1	1	1	1	1	1	1	1	1
FEC Blocks / Interleaving Frame	36	65,132	68,132	66,133,169	68,132,176	62,132,183	16,34,48 (QPSK) 32,68,97 (16QAM) 48,97,146 (64QAM) 64,130,195 (256QAM)	67,135,185	63,135,200	135,200	64,135,200	16,34,50 (QPSK) 33,69,100 (16QAM) 49,99,150 (64QAM) 66,133,200 (256QAM)
Code rate	2/3	3/4	2/3	3/4	3/5,2/3,3/4	3/5,2/3,3/4	All	3/4	3/5	3/5, 2/3, 3/4	3/5,2/3,3/4	All
Modulation	256 QAM	256 QAM	256 QAM	256 QAM	256 QAM	256 QAM	25 6QAM	256 QAM	256 QAM	256 QAM	256 QAM	256 QAM
BUFS	TBD	TBD	TBD	TBD	TBD	TBD	TBD	TBD	TBD	TBD	TBD	TBD
Design Delay	TBD	TBD	TBD	TBD	TBD	TBD	TBD	TBD	TBD	TBD	TBD	TBD

**Table 2.17 DVB-T2 mode parameters in DVB-T2 Single PLP (mode A) test tasks.** \*) any allowed value



	NU_M1	NU_M2 (VV702-TDICC3)	NU_M3 (VV708-DJBCC2)	NU_M4 (VV710-TDICC1)
Bandwidth	8MHz	8MHz	8MHz	8MHz
FFT	32k	32k	32k	32k
Carrier mode	Extended	Extended	Extended	Extended
SISO/MISO	SISO	SISO	SISO	SISO
Guard Interval	1/16	1/128	1/128	1/128
Version	1.2.1	1.2.1	1.2.1	1.2.1
$L_f$	28 **)	28 **)	28 **)	28 **)
Pilot pattern	PP4	PP7	PP7	PP7
TFS	No	No	No	No
FEF	Not used	Not used	Not used	Used
Auxiliary streams	Not used	Not used	Not used	Not used
Cell ID	*)	*)	*)	*)
Network ID	*)	*)	*)	*)
T2 System ID	*)	*)	*)	*)
Subslices / T2 frame	135	1	108	108
Frames / Superframe	2	2	2	4
L1 FEC type	16k LDPC	16k LDPC	16k LDPC	16k LDPC
L1 repetition	0	0	0	0
L1 extension	No	No	No	No
L1 Modulation	64QAM	16QAM	16QAM	16QAM
L1_ACE_MAX	0	0	0	0
L1 bias balancing cells	No	No	No	No
PAPR	L1-ACE & TR	L1-ACE & TR	L1-ACE & TR	L1-ACE & TR
PAPR: $V_{clip}$	3.1V	Infinity	Infinity	Infinity
PAPR: Number of iterations	10	TBD	TBD	TBD
Input TS bit rate [MBit/s]	TBD	36.234886	38.030308	5955840/178801 = 33.309880

	NU_M1			NU_M2 (VV702-TDICC3)					NU_M3 (VV708-DJBCC2)					NU_M4 (VV710-TDICC1)				
Number of PLPs	3			5					5					5				
PLP id	0	1	2	0	1	2	3	4	0	1	2	3	4	0	1	2	3	4
Constellation rotation	Yes	Yes	Yes	Yes	Yes	Yes	Yes	Yes	Yes	Yes	Yes	Yes	Yes	Yes	Yes	Yes	Yes	Yes
PLP FEC type	16k LDPC	64k LDPC	64k LDPC	64k LDPC	64k LDPC	64k LDPC	64k LDPC	16k LDPC	64k LDPC	64k LDPC	64k LDPC	64k LDPC	16k LDPC	64k LDPC	64k LDPC	64k LDPC	64k LDPC	16k LDPC
FEC Frame length	16200	64800	64800	TBD	TBD	TBD	TBD	TBD	TBD	TBD	TBD	TBD	TBD	TBD	TBD	TBD	TBD	TBD
Baseband Mode	HEM	HEM	HEM	HEM	HEM	HEM	HEM	HEM	HEM	HEM	HEM	HEM	HEM	HEM	HEM	HEM	HEM	HEM
ISSY	Long	Long	Long	Long	Long	Long	Long	Long	Long	Long	Long	Long	Long	Long	Long	Long	Long	Long
In band signaling	Type A & B	Type A & B	Type A & B	Type A	Type A	Type A	Type A	Type A	Type A	Type A	Type A	Type A	Type A	Type A	Type A	Type A	Type A	Type A
Number of other PLPs in-band signalling	0	0	0	0	0	0	0	0	0	0	0	0	0	0	0	0	0	0
Null packet deletion	Enabled	Enabled	Enabled	Enabled	Enabled	Enabled	Enabled	Enabled	Enabled	Enabled	Enabled	Enabled	Enabled	Enabled	Enabled	Enabled	Enabled	Enabled
Time interval blocks per frame	TBD	TBD	TBD	1	1	1	1	1	1	1	1	1	1	1	1	1	1	1
Time interleaver length	1	1	1	1	1	1	1	1	1	1	1	1	1	1	1	1	1	1
Frame interval	1	1	1	1	1	1	1	1	1	1	1	1	1	1	1	1	1	1
Time interleaver type	0	0	0	0	0	0	0	0	0	0	0	0	0	0	0	0	0	0
T2 frames / Interleaver frame	1	1	1	1	1	1	1	1	1	1	1	1	1	1	1	1	1	1
First frame index	0	0	0	0	0	0	0	0	0	0	0	0	0	0	0	0	0	0
Group id	1	1	1	0	0	0	0	0	0	0	0	0	0	0	0	0	0	0
PLP type	Common	DT 2	DT 2	DT 1	DT 1	DT 1	DT 1	Common	DT 2	DT 2	DT 2	DT 2	Common	DT2	DT2	DT2	DT2	Common
FEC Blocks / Interleaving Frame	Non-dynamic 35	Non-dynamic 57	Non-dynamic 57	Dynamic max 57	Dynamic max 57	Dynamic max 22	Dynamic max 22	17	Dynamic max 57	Dynamic max 57	Dynamic max 57	Dynamic max 57	35	Dynamic max 57	Dynamic max 57	Dynamic max 57	Dynamic max 57	33
Total FEC blocks	TBD	TBD	TBD	85	85	85	85	17	82	82	82	82	35	81	81	81	81	33
Max cells / T2 frame	TBD	TBD	TBD	688500	688500	688500	688500	45900	TBD	TBD	TBD	TBD	TBD	656100	656100	656100	656100	89100
Code rate	2/3	2/3	2/3	2/3	2/3	2/3	2/3	2/3	2/3	2/3	2/3	2/3	2/3	2/3	2/3	2/3	2/3	2/3
Modulation	64 QAM	256 QAM	256 QAM	256 QAM	256 QAM	256 QAM	256 QAM	64 QAM	256 QAM	256 QAM	256 QAM	256 QAM	64QAM	256 QAM	256 QAM	256 QAM	256 QAM	64QAM
BUFS	483328	1613824	1613824	1613824	1613824	1613824	1613824	483328	1671168	1671168	1671168	1671168	425984	1662976	1662976	1662976	1662976	434176
Design delay	989615	989615	989615	939080	939080	939080	939080	939080	935798	935798	935798	935798	935798	939195	939195	939195	939195	939195

**Table 2.18 DVB-T2 mode parameters in DVB-T2 Multiple PLP (mode B) test tasks.** \*) any allowed value \*\*) maximum achieved value may depend on content in PLPs



**NorDig**

85 (457)

NorDig Unified Test plan, ver 2.6.0

Due to the deployment situation for DVB-T2 transmissions in networks is different, several alternatives for  $L_f$  and FEC blocks / interleaving frame are given.

Normally signal bandwidth of the DVB-T2 mode is specified for the on-air signals on VHF and UHF frequencies. For off-air signals in cable networks the signal bandwidth relation to frequency band is not obvious, e.g. when reception from on-air 8MHz signal bandwidth on UHF is downconverted to VHF off-air distribution.

### 2.3.8 Stream packet structure in Receiver Buffer Model (RBM) tests for DVB-T2

Test tasks Task 3:41, Task 3:42, Task 3:43 and Task 3:46 stress the receiver buffer model. TS contains a service with a real video and audio. Prerequisite is that the modulator shall support V&V packet generation architecture. Figure 2 shows Task 3:41 chapter 2 packet structure. Compilation of the TSs to PLPs and recompilation back to TSs are explained more detailed in [4]. Video and audio content carried within common PLP is used for test purposes in order to make it possible to test IRD subjectively. Most probably that is not a normal use of common PLP although common PLP allows contain video and audio content. To make sure broadcast network operator's use of common PLP, the broadcast network operator should be consulted.

Defined RBM test method can only test one PLP at a time, therefore the RBM tests have to be run with a separate stream for each PLP to be tested.

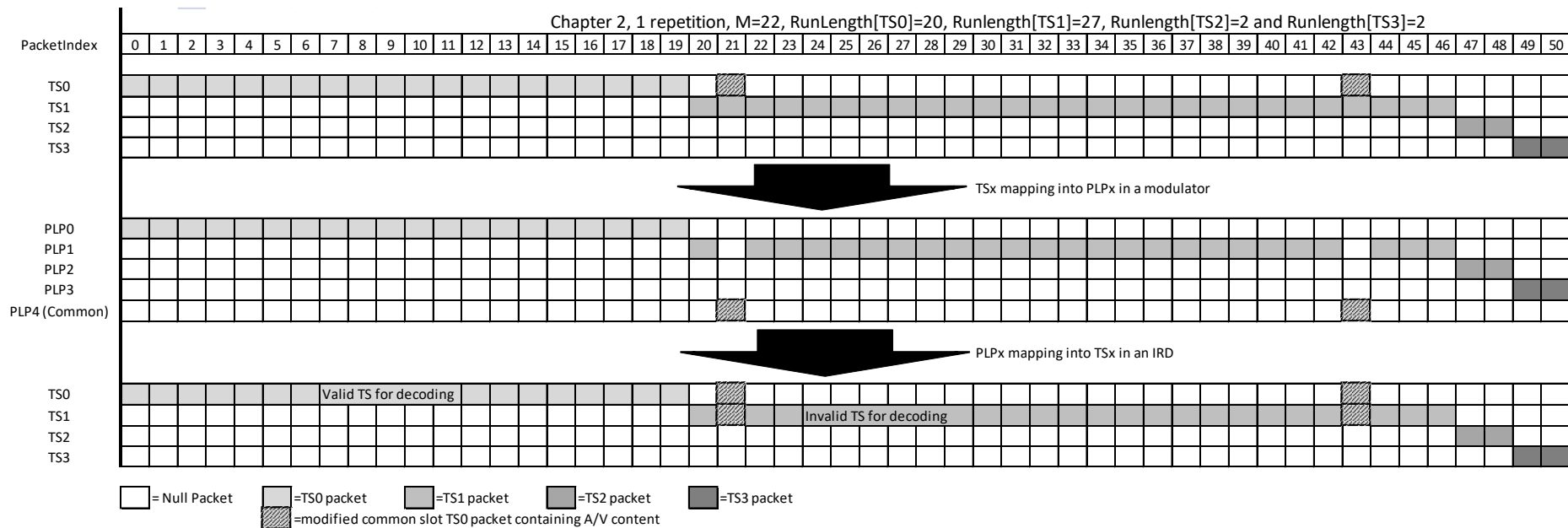

**Figure 2. Example of compilation of Task 3:41 TSs to PLPs and recompilation back to TSs. Figure shows only chapter 2 where repetition is 1 for a modulator supporting V&V stream compilation and IRD demodulating the received DVB-T2 signal. The recompiled TS0 results to a valid TS for decoding.**

### 2.3.9 Test cases

#### 2.3.9.1 Test cases – DVB-T IRD

<b>Test Case</b>	<b>Task 3:1 General</b>	
<b>Section</b>	NorDig Unified 3.4.1	
<b>Requirement</b>	The NorDig IRD shall include at least one tuner/demodulator for reception of signals from terrestrial transmitters, broadcasting in accordance with EN 300 744 [21] (DVB-T).	
<b>IRD profile(s)</b>	Basic, IRD, DVB-T	
<b>Test procedure</b>	<p><b>Purpose of test:</b> To verify the possibility of the reception of the DVB-T signal.</p> <p><b>Equipment:</b> An IRD.</p> <p><b>Test procedure:</b> Make sure that the IRD has one tuner/demodulator for reception of terrestrial signals.</p> <p><b>Expected result:</b> IRD has one tuner/demodulator for terrestrial reception.</p>	
<b>Test result(s)</b>		
<b>Conformity</b>	<input type="checkbox"/> <b>OK Fault</b> <input type="checkbox"/> Major <input type="checkbox"/> Minor, define fail reason in comments	
<b>Comments</b>	If possible describe if fault can be fixed with software update: <input type="checkbox"/> <b>YES</b> <input type="checkbox"/> <b>NO</b> Describe more specific faults and/or other information	
<b>Date</b>		<b>Sign</b>

<b>Test Case</b>	<b>Task 3:2 General</b>	
<b>Section</b>	NorDig Unified 3.1.2	
<b>IRD profile(s)</b>	Basic, IRD, DVB-T	
<b>Requirement</b>	The NorDig IRD shall be able to automatically scan through the whole frequency range available for each of the available Tuners/Demodulators and tune in to the correct DVB framing structure, channel coding and modulation to deliver the incoming transport stream to the next units. The tuning data shall be stored in a service list, in order to allow a quick tune in to the selected transport stream. For more detail see below.	
<b>Test procedure</b>	<p><b>Purpose of test:</b> To verify that IRD is able to scan through the whole frequency range.</p> <p><b>Test procedure:</b> This is common requirement and will be verified in the following tests.</p>	
<b>Test result(s)</b>	The manufacturer describes his specific setup for the test	
<b>Conformity</b>	<input type="checkbox"/> <b>OK Fault</b> <input type="checkbox"/> Major <input type="checkbox"/> Minor, define fail reason in comments	
<b>Comments</b>	If possible describe if fault can be fixed with software update: <input type="checkbox"/> <b>YES</b> <input type="checkbox"/> <b>NO</b> Describe more specific faults and/or other information	
<b>Date</b>		<b>Sign</b>



<b>Test Case</b>	<b>Task 3:3 Quality reception detector</b>	
<b>Section</b>	NorDig Unified 3.1.3	
<b>Requirement</b>	The NorDig Unified receiver shall be equipped with a reception quality detector.	
<b>IRD profile(s)</b>	Basic, IRD, DVB-T	
<b>Test procedure</b>	<p><b>Equipment:</b> IRD under test.</p> <p><b>Test procedure:</b> Check that the IRD is equipped with a reception quality detector</p> <p><b>Expected result:</b> It shall be possible to access some kind of a reception quality detector.</p>	
<b>Test result(s)</b>		
<b>Conformity</b>	<input type="checkbox"/> <b>OK Fault</b> <input type="checkbox"/> Major <input type="checkbox"/> Minor, define fail reason in comments	
<b>Comments</b>	If possible describe if fault can be fixed with software update: <input type="checkbox"/> <b>YES</b> <input type="checkbox"/> <b>NO</b> Describe more specific faults and/or other information	
<b>Date</b>		<b>Sign</b>

<b>Test Case</b>	<b>Task 3:4 Frequencies: Center frequencies</b>	
<b>Section</b>	NorDig Unified 3.4.2.1 and 3.4.2.2	
<b>Requirement</b>	<p>The NorDig IRD shall be able to receive channels in VHF band III and UHF bands IV, V and should be able to receive channels in VHF S band I, VHF S band II, UHF S Band III.</p> <p>The front-end shall for the supported frequency ranges be capable of tuning to the center frequency <math>f_c</math> of the incoming DVB-T RF signal, see below.</p> <p>8MHz raster: <math>f_c = 114 \text{ MHz} + K * 8 \text{ MHz}</math>, where <math>K = 0 \dots 93</math>          7MHz raster: <math>f_c = 107.5 \text{ MHz} + L * 7 \text{ MHz}</math>, where <math>L = 0 \dots 27</math></p>	
<b>IRD profile(s)</b>	Basic, IRD, DVB-T	
<b>Test procedure</b>	<p><b>Purpose of test:</b> To verify the reception over the supported frequency range.</p> <p><b>Equipment:</b></p> <pre> graph LR     A[MPEG-2 source] --- B[DVB-T modulator]     B --- C[Up-converter]     C --- D[DVB-T Receiver]     D --- E[Monitor]           </pre> <p><b>Test procedure:</b></p> <ol style="list-style-type: none"> <li>1. Set up the test instruments</li> <li>2. Use the following mode 8k 64QAM, HP Code rate=2/3, Guard interval <math>T_U/8</math></li> <li>3. Use input level of -60 dBm</li> <li>4. Start with frequency 177,5MHz (K5)</li> <li>5. Use the quality measurement procedures 1 (QMP1).</li> <li>6. Fill the result in the measurement record: <b>OK</b> or <b>NOK</b>.</li> <li>7. Repeat the test for all channels in the table 1 in the measurement record.</li> </ol>	



8. If the receiver supports optional frequency ranges, test all remaining channels in table 2 and 3 in the measurement record.

**Expected result:**

The result of the test shall be OK for all channels in table 1.

For the optionally supported frequency ranges, the tests shall be OK for the channels in the tables 2 and 3.



Test result(s)

Band	Channel	Frequency [MHz]	BW [MHz]	Result OK or NOK	
VHF III	K5	177.5	7		
	K6	184.5	7		
	K7	191.5	7		
	K8	198.5	7		
	K9	205.5	7		
	K10	212.5	7		
	K11	219.5	7		
	K12	226.5	7		
	UHF IV/V	K21	474	8	
		K22	482	8	
		K23	490	8	
		K24	498	8	
K25		506	8		
K26		514	8		
K27		522	8		
K28		530	8		
K29		538	8		
K30		546	8		
K31		554	8		
K32		562	8		
K33		570	8		
K34		578	8		
K35		586	8		
K36		594	8		
K37		602	8		
K38		610	8		
K39		618	8		
K40		626	8		
K41		634	8		
K42		642	8		
K43		650	8		
K44		658	8		
K45		666	8		
K46		674	8		
K47		682	8		
K48		690	8		
K49		698	8		
K50		706	8		
K51		714	8		
K52		722	8		
K53		730	8		
K54		738	8		
K55		746	8		
K56		754	8		
K57		762	8		
K58		770	8		
K59		778	8		
K60		786	8		
K61		794	8		
K62		802	8		
K63		810	8		
K64		818	8		
K65		826	8		
K66		834	8		
K67		842	8		
K68		850	8		
K69		858	8		

Table 1. Mandatory center frequencies and signal bandwidths to receive



Test result(s)

Band	Channel	Frequency [MHz]	BW [MHz]	Result 7MHz OK or NOK	BW [MHz]	Result 8MHz OK or NOK
VHF S I	D1	114.0	7		8	
	S2	114.5	7		8	
	S3	121.5	7		8	
	D2	122.0	7		8	
	S4	128.5	7		8	
	D3	130.0	7		8	
	S5	135.5	7		8	
	D4	138.0	7		8	
	S6	142.5	7		8	
	D5	146.0	7		8	
	S7	149.5	7		8	
	D6	154.0	7		8	
	S8	156.5	7		8	
	D7	162.0	7		8	
S9	163.5	7		8		
D8	170.0	7		8		
S10	170.5	7		8		
VHF III	K5	177.5	7		8	
	D9	178.0	7		8	
	K6	184.5	7		8	
	D10	186.0	7		8	
	K7	191.5	7		8	
	D11	194.0	7		8	
	K8	198.5	7		8	
	D12	202.0	7		8	
	K9	205.5	7		8	
	D13	210.0	7		8	
	K10	212.5	7		8	
	D14	218.0	7		8	
	K11	219.5	7		8	
	D15	226.0	7		8	
K12	226.5	7		8		
VHF S II	S11	233.5	7		8	
	D16	234.0	7		8	
	S12	240.5	7		8	
	D17	242.0	7		8	
	S13	247.5	7		8	
	D18	250.0	7		8	
	S14	254.5	7		8	
	D19	258.0	7		8	
	S15	261.5	7		8	
	D20	266.0	7		8	
	S16	268.5	7		8	
	D21	274.0	7		8	
	S17	275.5	7		8	
	D22	282.0	7		8	
S18	282.5	7		8		
S19	289.5	7		8		
D23	290.0	7		8		
S20	296.5	7		8		
D24	298.0	7		8		

Table 2 Optional VHF center frequencies and signal bandwidths to receive.

<b>Test results(s)</b>	<table border="1"> <thead> <tr> <th>Band</th> <th>Channel</th> <th>Frequency [MHz]</th> <th>BW [MHz]</th> <th>Result OK or NOK</th> </tr> </thead> <tbody> <tr><td rowspan="21">UHF S III</td><td>S21</td><td>306.0</td><td>8</td><td></td></tr> <tr><td>S22</td><td>314.0</td><td>8</td><td></td></tr> <tr><td>S23</td><td>322.0</td><td>8</td><td></td></tr> <tr><td>S24</td><td>330.0</td><td>8</td><td></td></tr> <tr><td>S25</td><td>338.0</td><td>8</td><td></td></tr> <tr><td>S26</td><td>346.0</td><td>8</td><td></td></tr> <tr><td>S27</td><td>354.0</td><td>8</td><td></td></tr> <tr><td>S28</td><td>362.0</td><td>8</td><td></td></tr> <tr><td>S29</td><td>370.0</td><td>8</td><td></td></tr> <tr><td>S30</td><td>378.0</td><td>8</td><td></td></tr> <tr><td>S31</td><td>386.0</td><td>8</td><td></td></tr> <tr><td>S32</td><td>394.0</td><td>8</td><td></td></tr> <tr><td>S33</td><td>402.0</td><td>8</td><td></td></tr> <tr><td>S34</td><td>410.0</td><td>8</td><td></td></tr> <tr><td>S35</td><td>418.0</td><td>8</td><td></td></tr> <tr><td>S36</td><td>426.0</td><td>8</td><td></td></tr> <tr><td>S37</td><td>434.0</td><td>8</td><td></td></tr> <tr><td>S38</td><td>442.0</td><td>8</td><td></td></tr> <tr><td>S39</td><td>450.0</td><td>8</td><td></td></tr> <tr><td>S40</td><td>458.0</td><td>8</td><td></td></tr> <tr><td>S41</td><td>466.0</td><td>8</td><td></td></tr> </tbody> </table>				Band	Channel	Frequency [MHz]	BW [MHz]	Result OK or NOK	UHF S III	S21	306.0	8		S22	314.0	8		S23	322.0	8		S24	330.0	8		S25	338.0	8		S26	346.0	8		S27	354.0	8		S28	362.0	8		S29	370.0	8		S30	378.0	8		S31	386.0	8		S32	394.0	8		S33	402.0	8		S34	410.0	8		S35	418.0	8		S36	426.0	8		S37	434.0	8		S38	442.0	8		S39	450.0	8		S40	458.0	8		S41	466.0	8	
	Band	Channel	Frequency [MHz]	BW [MHz]	Result OK or NOK																																																																																									
	UHF S III	S21	306.0	8																																																																																										
		S22	314.0	8																																																																																										
		S23	322.0	8																																																																																										
		S24	330.0	8																																																																																										
		S25	338.0	8																																																																																										
		S26	346.0	8																																																																																										
		S27	354.0	8																																																																																										
		S28	362.0	8																																																																																										
		S29	370.0	8																																																																																										
		S30	378.0	8																																																																																										
		S31	386.0	8																																																																																										
		S32	394.0	8																																																																																										
		S33	402.0	8																																																																																										
		S34	410.0	8																																																																																										
		S35	418.0	8																																																																																										
		S36	426.0	8																																																																																										
		S37	434.0	8																																																																																										
		S38	442.0	8																																																																																										
		S39	450.0	8																																																																																										
S40		458.0	8																																																																																											
S41		466.0	8																																																																																											
Table 3 Optional UHF center frequencies and signal bandwidth to receive.																																																																																														
<b>Conformity</b>	<input type="checkbox"/> <b>OK Fault</b> <input type="checkbox"/> Major <input type="checkbox"/> Minor, define fail reason in comments																																																																																													
<b>Comments</b>	If possible describe if fault can be fixed with software update: <input type="checkbox"/> <b>YES</b> <input type="checkbox"/> <b>NO</b> Describe more specific faults and/or other information																																																																																													
<b>Date</b>		<b>Sign</b>																																																																																												

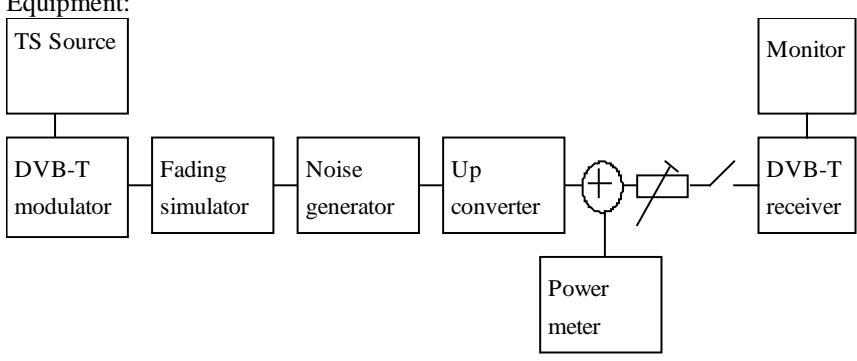
<b>Test Case</b>	<b>Task 3:5 Frequencies: Frequency offset</b>
<b>Section</b>	NorDig Unified 3.4.2.3
<b>Requirement</b>	The NorDig IRD shall be able to receive signals with an offset of up to 50kHz from the nominal frequency.
<b>IRD profile(s)</b>	Basic, IRD, DVB-T
<b>Test procedure</b>	<p><b>Purpose of test:</b> To verify that the reception is possible in specified frequency offset from nominal frequency.</p> <p>Equipment:</p>  <pre> graph LR     TS[TS Source] --&gt; Mod[DVB-T modulator]     Mod --&gt; Fading[Fading simulator]     Fading --&gt; Noise[Noise generator]     Noise --&gt; Up[Up converter]     Up --&gt; Sum((+))     PM[Power meter] --- Sum     Sum --&gt; Receiver[DVB-T receiver]     Receiver --&gt; Monitor[Monitor] </pre> <p><b>Test procedure:</b></p> <ol style="list-style-type: none"> <li>1. Set up the test instruments</li> <li>2. Use the following mode: 8k, 64QAM, Code rate=2/3, Guard interval <math>T_U/8</math></li> </ol>

	<ol style="list-style-type: none"> <li>3. Use input level of -60 dBm</li> <li>4. Set the center frequency to 177.5 MHz and frequency offset to 0 kHz. Use signal bandwidth 7MHz.</li> <li>5. Connect receiver and do the channel search if needed.</li> <li>6. Test with the specified frequency offset values in the measurement record. Before changing the frequency offset, disconnect the receiver from the received RF signal.</li> <li>7. Do the change of frequency offset,</li> <li>8. Connect the received RF signal back to the receiver.</li> <li>9. Use the quality measurement procedure 1 (QMP1)</li> <li>10. Fill the result in the measurement record: <b>OK</b> or <b>NOK</b>.</li> <li>11. Test the remaining frequency offset values on specified center frequencies and signal bandwidths in the measurement record.</li> </ol> <p><b>Expected result:</b> The test shall be OK for all frequency offset values on specified center frequencies and signal bandwidths.</p>
--	-----------------------------------------------------------------------------------------------------------------------------------------------------------------------------------------------------------------------------------------------------------------------------------------------------------------------------------------------------------------------------------------------------------------------------------------------------------------------------------------------------------------------------------------------------------------------------------------------------------------------------------------------------------------------------------------------------------------------------------------------------------------------------------------------------------------------------------------------------------------------------------------------------------------------------------------------------------------------------------------------------

<i>Test result(s)</i>	<table border="1" style="margin-left: auto; margin-right: auto;"> <thead> <tr> <th>Channel</th> <th>Signal BW [MHz]</th> <th>Frequency [MHz]</th> <th>Offset [kHz]</th> <th>Result OK or NOK</th> </tr> </thead> <tbody> <tr> <td rowspan="3">K5</td> <td>7</td> <td>177.5</td> <td>-50</td> <td></td> </tr> <tr> <td>7</td> <td>177.5</td> <td>0</td> <td></td> </tr> <tr> <td>7</td> <td>177.5</td> <td>+50</td> <td></td> </tr> <tr> <td rowspan="3">K12</td> <td>7</td> <td>226.5</td> <td>-50</td> <td></td> </tr> <tr> <td>7</td> <td>226.5</td> <td>0</td> <td></td> </tr> <tr> <td>7</td> <td>226.5</td> <td>+50</td> <td></td> </tr> <tr> <td rowspan="3">K21</td> <td>8</td> <td>474.0</td> <td>-50</td> <td></td> </tr> <tr> <td>8</td> <td>474.0</td> <td>0</td> <td></td> </tr> <tr> <td>8</td> <td>474.0</td> <td>+50</td> <td></td> </tr> <tr> <td rowspan="3">K69</td> <td>8</td> <td>858.0</td> <td>-50</td> <td></td> </tr> <tr> <td>8</td> <td>858.0</td> <td>0</td> <td></td> </tr> <tr> <td>8</td> <td>858.0</td> <td>+50</td> <td></td> </tr> </tbody> </table>	Channel	Signal BW [MHz]	Frequency [MHz]	Offset [kHz]	Result OK or NOK	K5	7	177.5	-50		7	177.5	0		7	177.5	+50		K12	7	226.5	-50		7	226.5	0		7	226.5	+50		K21	8	474.0	-50		8	474.0	0		8	474.0	+50		K69	8	858.0	-50		8	858.0	0		8	858.0	+50	
Channel	Signal BW [MHz]	Frequency [MHz]	Offset [kHz]	Result OK or NOK																																																						
K5	7	177.5	-50																																																							
	7	177.5	0																																																							
	7	177.5	+50																																																							
K12	7	226.5	-50																																																							
	7	226.5	0																																																							
	7	226.5	+50																																																							
K21	8	474.0	-50																																																							
	8	474.0	0																																																							
	8	474.0	+50																																																							
K69	8	858.0	-50																																																							
	8	858.0	0																																																							
	8	858.0	+50																																																							

<i>Conformity</i>	<input type="checkbox"/> <b>OK</b> <input type="checkbox"/> <b>Fault</b> <input type="checkbox"/> Major <input type="checkbox"/> Minor, define fail reason in comments
-------------------	------------------------------------------------------------------------------------------------------------------------------------------------------------------------

<i>Comments</i>	If possible describe if fault can be fixed with software update: <input type="checkbox"/> <b>YES</b> <input type="checkbox"/> <b>NO</b> Describe more specific faults and/or other information
-----------------	---------------------------------------------------------------------------------------------------------------------------------------------------------------------------------------------------

<i>Date</i>		<i>Sign</i>	
-------------	--	-------------	--

<i>Test Case</i>	<b>Task 3:6 Frequencies: Signal bandwidths</b>
<i>Section</i>	NorDig Unified 3.4.2.4
<i>Requirement</i>	<p>VHF Bands: The NorDig IRD shall for the supported frequency ranges be able to receive 7 MHz and should be able to receive 8 MHz DVB-T signals. If 8 MHz bandwidth is supported it shall automatically detect which DVB-T signal bandwidth is being used, and it shall be possible to receive the 8 MHz DVB-T signals on the 7 MHz channel frequency raster.</p> <p>UHF Bands: The NorDig IRD shall for the supported frequency ranges be able to receive 8 MHz DVB-T signals.</p> <p>(For a DVB-T signal, an 8 MHz DVB-T signal corresponds to a signal bandwidth of</p>

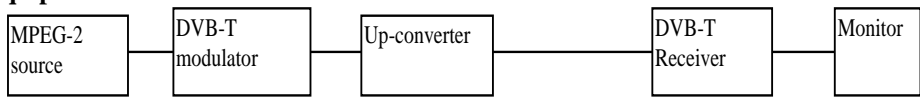
	7.61 MHz and a 7 MHz DVB-T signal corresponds to a signal bandwidth of 6.66 MHz.)																				
<b>IRD profile(s)</b>	Basic, IRD, DVB-T																				
<b>Test procedure</b>	<p><b>Purpose of test:</b> To verify that the receiver is able to automatically detect the transmitted signal bandwidth and do the required adaptations for QEF reception.</p> <p>(The reception of the different signal bandwidths on supported frequency ranges are tested in previous test).</p> <p><b>Equipment:</b></p>  <pre> graph LR     A[MPEG-2 source] --&gt; B[DVB-T modulator]     B --&gt; C[Up-converter]     C --&gt; D[DVB-T Receiver]     D --&gt; E[Monitor]   </pre> <p><b>Test procedure:</b></p> <ol style="list-style-type: none"> <li>1. Set up the test instruments.</li> <li>2. Use the transmission frequency UHF IV/V 666 MHz (K45) and an input level of -60 dBm to the receiver.</li> <li>3. Use the DVB-T mode 8k 64QAM FEC R=2/3 Δ/Tu=1/8 and signal bandwidth 8MHz.</li> <li>4. Connect the receiver and perform an automatic or manual channel search. The signal bandwidth initialization shall not be required by the user.</li> <li>5. Use the quality measurement procedure 1.</li> <li>6. Fill the result in the measurement record: <b>OK</b> or <b>NOK</b>.</li> <li>7. Change the transmission frequency to VHF III channel 198.5 MHz (K8) and signal bandwidth to 7 MHz.</li> <li>8. Verify that the channel list does not have any services installed by performing initialization to factory defaults or in such way.</li> <li>9. Do an automatic or manual channel search. The signal bandwidth initialization shall not be required by the user.</li> <li>10. Use the quality measurement procedure 1 (QMP1).</li> <li>11. Fill the result in the measurement record: <b>OK</b> or <b>NOK</b>.</li> </ol> <p><b>Expected result:</b> The test results shall be OK for all tests in the table 1 in the measurement record and user does not have to initialize the signal bandwidth for the succesfull channel search and QEF reception.</p> <p>If 8MHz signal bandwidth in VHF is supported the test result shall be OK for the test in the table 2 in the measurement record. If the 8MHz signal bandwidth in VHF is not supported, this test result can be NOK.</p>																				
<b>Test result(s)</b>	<p>Measurement record:</p> <table border="1" data-bbox="488 1653 1241 1783"> <thead> <tr> <th>Channel</th> <th>Frequency [MHz]</th> <th>Signal bandwidth [MHz]</th> <th>Result OK or NOK</th> </tr> </thead> <tbody> <tr> <td>K8</td> <td>198.5</td> <td>7</td> <td></td> </tr> <tr> <td>K45</td> <td>666.0</td> <td>8</td> <td></td> </tr> </tbody> </table> <p>Table 1 Mandatory signal bandwidths to receive</p> <table border="1" data-bbox="488 1843 1241 1937"> <thead> <tr> <th>Channel</th> <th>Frequency [MHz]</th> <th>Signal bandwidth [MHz]</th> <th>Result OK or NOK</th> </tr> </thead> <tbody> <tr> <td>K8</td> <td>198.5</td> <td>8</td> <td></td> </tr> </tbody> </table> <p>Table 2 Optional signal bandwidth to receive.</p>	Channel	Frequency [MHz]	Signal bandwidth [MHz]	Result OK or NOK	K8	198.5	7		K45	666.0	8		Channel	Frequency [MHz]	Signal bandwidth [MHz]	Result OK or NOK	K8	198.5	8	
Channel	Frequency [MHz]	Signal bandwidth [MHz]	Result OK or NOK																		
K8	198.5	7																			
K45	666.0	8																			
Channel	Frequency [MHz]	Signal bandwidth [MHz]	Result OK or NOK																		
K8	198.5	8																			
<b>Conformity</b>	<input type="checkbox"/> <b>OK</b> <input type="checkbox"/> <b>Fault</b> <input type="checkbox"/> <b>Major</b> <input type="checkbox"/> <b>Minor</b> , define fail reason in comments																				



<b>Comments</b>	If possible describe if fault can be fixed with software update: <input type="checkbox"/> YES <input type="checkbox"/> NO Describe more specific faults and/or other information		
<b>Date</b>		<b>Sign</b>	

<b>Test Case</b>	<b>Task 3:7 Modes</b>																																																																
<b>Section</b>	NorDig Unified 3.4.3																																																																
<b>Requirement</b>	<p>The NorDig IRD terrestrial front end shall be capable of correctly demodulating all non-hierarchical modes specified in EN 300 744.</p> <p>The front end shall therefore be able to work with any combination of constellation (QPSK, 16-QAM or 64-QAM), code rate (1/2, 2/3, 3/4, 5/6 or 7/8), guard interval (<math>T_u/4</math>, <math>T_u/8</math>, <math>T_u/16</math> or <math>T_u/32</math>) and transmission mode (2K or 8K).</p> <p>The IRD shall automatically detect which mode is being used.</p> <p>The NorDig IRD should be able to receiver the hierarchical modes in the DVB-T specification.</p>																																																																
<b>IRD profile(s)</b>	Basic, IRD, DVB-T																																																																
<b>Test procedure</b>	<p><b>Purpose of test:</b> To verify the reception of all non-hierarchical DVB-T modes.</p> <p><b>Equipment:</b></p> <pre> graph LR     A[MPEG-2 source] --- B[DVB-T modulator]     B --- C[Up-converter]     C --- D[DVB-T Receiver]     D --- E[Monitor]     </pre> <p><b>Test procedure:</b></p> <ol style="list-style-type: none"> <li>Set up the test instruments.</li> <li>Use channel 45 and an input level of -60 dBm.</li> <li>Start with the mode 8k QPSK FEC R=1/2 <math>\Delta/T_u=1/32</math> and signal bandwidth 8 MHz.</li> <li>Use the quality measurement procedure 1 (QMP1).</li> <li>Fill the result in the measurement record: <b>OK</b> or <b>NOK</b>.</li> <li>Perform the same test for the remaining 119 8k and 2k modes.</li> </ol> <p><b>Expected result:</b> The test shall be OK for all modes.</p>																																																																
<b>Test result(s)</b>	<p>Measurement record:</p> <table border="1"> <thead> <tr> <th>8K</th> <th>FEC</th> <th>Tg=1/32</th> <th>Tg=1/16</th> <th>Tg=1/8</th> <th>Tg=1/4</th> </tr> </thead> <tbody> <tr><td>QPSK</td><td>1/2</td><td></td><td></td><td></td><td></td></tr> <tr><td>QPSK</td><td>2/3</td><td></td><td></td><td></td><td></td></tr> <tr><td>QPSK</td><td>3/4</td><td></td><td></td><td></td><td></td></tr> <tr><td>QPSK</td><td>5/6</td><td></td><td></td><td></td><td></td></tr> <tr><td>QPSK</td><td>7/8</td><td></td><td></td><td></td><td></td></tr> <tr><td>16QAM</td><td>1/2</td><td></td><td></td><td></td><td></td></tr> <tr><td>16QAM</td><td>2/3</td><td></td><td></td><td></td><td></td></tr> <tr><td>16QAM</td><td>3/4</td><td></td><td></td><td></td><td></td></tr> <tr><td>16QAM</td><td>5/6</td><td></td><td></td><td></td><td></td></tr> </tbody> </table>					8K	FEC	Tg=1/32	Tg=1/16	Tg=1/8	Tg=1/4	QPSK	1/2					QPSK	2/3					QPSK	3/4					QPSK	5/6					QPSK	7/8					16QAM	1/2					16QAM	2/3					16QAM	3/4					16QAM	5/6				
8K	FEC	Tg=1/32	Tg=1/16	Tg=1/8	Tg=1/4																																																												
QPSK	1/2																																																																
QPSK	2/3																																																																
QPSK	3/4																																																																
QPSK	5/6																																																																
QPSK	7/8																																																																
16QAM	1/2																																																																
16QAM	2/3																																																																
16QAM	3/4																																																																
16QAM	5/6																																																																

	16QAM	7/8				
	64QAM	1/2				
	64QAM	2/3				
	64QAM	3/4				
	64QAM	5/6				
	64QAM	7/8				
	2K	FEC	Tg=1/32	Tg=1/16	Tg=1/8	Tg=1/4
	QPSK	1/2				
	QPSK	2/3				
	QPSK	3/4				
	QPSK	5/6				
	QPSK	7/8				
	16QAM	1/2				
	16QAM	2/3				
	16QAM	3/4				
	16QAM	5/6				
	16QAM	7/8				
	64QAM	1/2				
	64QAM	2/3				
	64QAM	3/4				
64QAM	5/6					
64QAM	7/8					
<b>Conformity</b>	<input type="checkbox"/> <b>OK Fault</b> <input type="checkbox"/> Major <input type="checkbox"/> Minor, define fail reason in comments					
<b>Comments</b>	If possible describe if fault can be fixed with software update: <input type="checkbox"/> <b>YES</b> <input type="checkbox"/> <b>NO</b> Describe more specific faults and/or other information					
<b>Date</b>					<b>Sign</b>	

<b>Test Case</b>	<b>Task 3:8 Tuning/Scanning Procedure: General</b>					
<b>Section</b>	NorDig Unified 3.4.4.1					
<b>Requirement</b>	The IRD shall be able to provide a scanning procedure over the whole frequency range.  It shall also be able to receive and react on tuning parameters found in PSI/SI (e.g. NIT information).?					
<b>IRD profile(s)</b>	Basic, IRD, DVB-T					
<b>Test procedure</b>	<p><b>Purpose of test:</b> To verify that IRD is able to scan through the whole frequency range.</p> <p><b>Test procedure:</b> This is common requirement and will be verified in the following tests.</p>					
<b>Test result(s)</b>						
<b>Conformity</b>	<input type="checkbox"/> <b>OK Fault</b> <input type="checkbox"/> Major <input type="checkbox"/> Minor, define fail reason in comments					
<b>Comments</b>	If possible describe if fault can be fixed with software update: <input type="checkbox"/> <b>YES</b> <input type="checkbox"/> <b>NO</b> Describe more specific faults and/or other information					
<b>Date</b>					<b>Sign</b>	

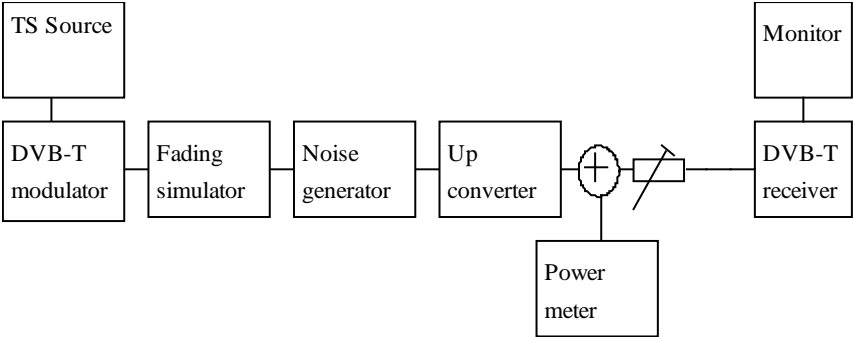

<b>Test Case</b>	<b>Task 3:9 Tuning/Scanning Procedures: Basic status check</b>			
<b>Section</b>	NorDig Unified 3.4.4.2			
<b>Requirement</b>	<p>The IRD shall provide at least a basic status check function (accessible through the Navigator) that presents reception quality information for a selected service (currently viewed by the user).</p> <p>The basic status check should be presented on the OSD and shall include:  channel id and center frequency  signal strength indicator and  reception quality indicator</p>			
<b>IRD profile(s)</b>	Basic, IRD, DVB-T			
<b>Test procedure</b>	<p><b>Purpose of test:</b> To verify that all the specified status information is displayed.</p> <p><b>Equipment:</b></p>  <pre> graph LR     TS[TS Source] --&gt; DVB_T[DVB-T modulator]     DVB_T --&gt; Fading[Fading simulator]     Fading --&gt; Noise[Noise generator]     Noise --&gt; Up[Up converter]     Up --&gt; Sum((+))     Sum --&gt; Att[Attenuator]     Att --&gt; DVB_T_R[DVB-T receiver]     DVB_T_R --&gt; Monitor[Monitor]     Sum --- PM[Power meter]     </pre> <p><b>Test procedure:</b></p> <ol style="list-style-type: none"> <li>Use DVB-T mode 8k 64QAM R=3/4 <math>\Delta/T_u=1/4</math>.</li> <li>Tune the IRD to an arbitrary service.</li> <li>Locate the status check function in the navigator and initiate it.</li> <li>Check that the channel number, signal strength and the reception quality indicators are displayed.</li> <li>Use gaussian channel configuration in fading simulator.</li> <li>Try several input signal levels from such a low input level (no picture at all) to a high input level by changing the attenuation in the attenuator.</li> <li>Decide if the indicated values of the signal strength indicator are reasonable.</li> <li>After each change of input signal level check that the signal strength indicator is updated.</li> <li>Configure 0dB 105<math>\mu</math>s echo in fading simulator and variate the C/N.</li> <li>Evaluate if the reception quality corresponds the real reception quality by changing the C/N from a low value to a high value. After each change of C/N check that the reception quality indicator is updated.</li> <li>Fill in the test protocol.</li> </ol> <p><b>Expected result:</b> All test results are OK.</p>			
<b>Test result(s)</b>	<p>Measurement record</p> <table border="1" data-bbox="437 2011 1294 2038"> <tr> <td><b>Requirement</b></td> <td><b>NOK or OK</b></td> </tr> </table>		<b>Requirement</b>	<b>NOK or OK</b>
<b>Requirement</b>	<b>NOK or OK</b>			

	Navigator has status check function.	
	The function shows the channel id and center frequency.	
	The function shows signal strength indicator.	
	.	
	Signal strength indicator is updated continuously.	
	The function has reception quality indicator.	
	Signal quality indicator is updated continuously.	
<b>Conformity</b>	<input type="checkbox"/> OK Fault <input type="checkbox"/> Major <input type="checkbox"/> Minor, define fail reason in comments	
<b>Comments</b>	If possible describe if fault can be fixed with software update: <input type="checkbox"/> YES <input type="checkbox"/> NO Describe more specific faults and/or other information	
<b>Date</b>		<b>Sign</b>

<b>Test Case</b>	<b>Task 3:10 Tuning/Scanning Procedures: Automatic channel search for the same service bouquet</b>
<b>Section</b>	NorDig Unified 3.4.4.4
<b>Requirement</b>	<p>The terrestrial NorDig IRD shall provide an automatic search that finds all of the multiplexes and services in the whole (supported) frequency range, see NorDig specification. The logic of the automatic search function shall be as follows:</p> <ul style="list-style-type: none"> <li>If any services are detected during the automatic search the current service list shall be replaced by the new service list.</li> <li>If no services are detected during the automatic search the current service list shall be kept or deleted.</li> </ul> <p>The IRD shall only display a service once in the service list (i.e. avoiding duplicate of the same services), even if the same service (same triplet original_network_id, transport_stream_id and service_id) is received from multiple transmitters. If the same service can be received from several transmitters, the one with best reception quality shall be selected. The criteria for selection of the best received service (i.e. best reception quality) shall be based on the combination of the signal strength and signal quality according to NorDig specification.</p>
<b>IRD profile(s)</b>	Basic, IRD, DVB-T
<b>Test procedure</b>	<p><b>Purpose of test:</b> To verify the best service selection in automatic channel search when the content of the transport stream is the same on several transmitters.</p> <p><b>Equipment:</b></p>

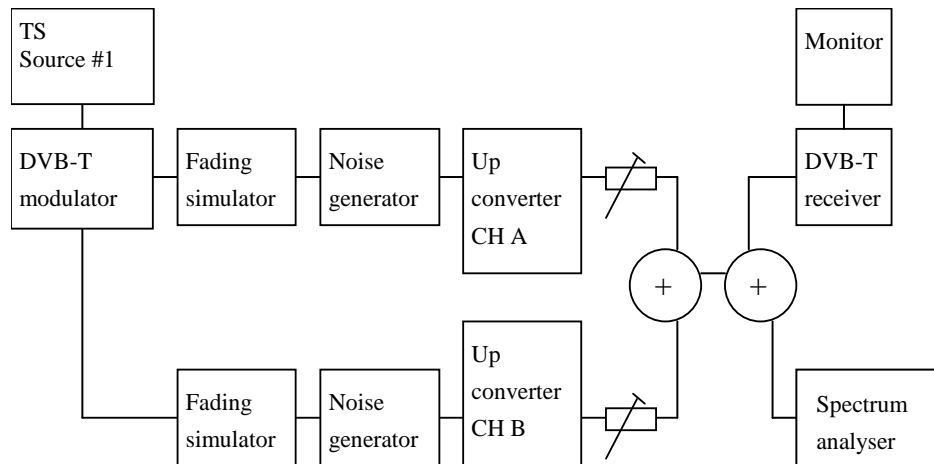

**Channels A and B**

**TS source #1**

**ONID=8945**

**Network ID=1000**

**Network Name=Net1**

**TSID=100**

**Services**

Name	SID	Logic Ch No
S1	1	1
S2	2	2
S3	3	3
S4	4	4

There is a possibility to receive broadcasts from several transmitters simultaneously in DVB-T network. These transmitters can have exactly the same content, but are transmitted on different channels (frequencies). Therefore, it is important that the receiver can choose by an automatic channel search the services with the best reception quality.

Test to verify broadcast where equal services are broadcasted simultaneously over DVB-T and DVB-T2 networks is not required.

Reception quality can be divided into two different parameters:

- Signal strength
- Signal quality

Signal quality can be divided into two main parameters:

- Signal-to-noise ratio (C/N)
- Bit error rate before Reed Solomon (BER before RS in DVB-T system)

Channels A and B shall not be equal.

Relative signal levels can be observed on spectrum analyser.

$\Delta S$  refers to difference in SSI according to [1] Annex D.

$\Delta Q$  refers to difference in SQI according to [1] Annex D.

AWGN refers to Additive White Gaussian Noise.

Test points 10-13 in table 20 below require the BER in each channel to be set in a specific way. Different signal generators provide different methods to degrade the signal. For example carriers can be disabled, or I/Q quadrature error introduced to achieve a specific BER.

As a pre-requisite to perform this test, IRD shall correctly pass the following tasks:

- Task 3:13 Verification of Signal Strength Indicator (SSI)
- Task 3:14 Verification of Signal Quality Indicator (SQI)

Measurement record 2 shows the minimum tests that shall be performed. Signal levels and signal quality (i.e added AWGN or additional BER impairments) can be adjusted from the initial values shown to ensure the required  $\Delta S$  and  $\Delta Q$  conditions are met.

**Test procedure:**

1. Configure the transport stream and setup the instruments. Use the DVB-T mode 8k 64QAM R=2/3  $\Delta/Tu=1/8$ .
2. Set the signal level of the both carriers CH A and CH B to the same level. The signal level shall correspond good reception quality (no errors in decoded video).
3. Perform automatic channel search. The logic of the automatic search function shall be as follows:
  - If any services are detected during the automatic search the current service list shall be replaced by the new service list.
  - If no services are detected during the automatic search the current service list shall be kept or deleted.
4. Check that the channel list has services configured in the transport stream.
5. Check that the services on the channel list is listed once and not duplicated. Check which channel is received by trying to attenuate the signal level. The services from received channel are frozen when the signal level is too low. [Restore the attenuations to the level before it was changed.](#)
6. Fill in OK or NOK in the measurement record 1 depending if the services were deleted.
7. Fill in OK or NOK in the measurement record 2 depending if the services were installed from expected channel.
8. Repeat the test for the rest of the test points in the measurement record 2.

**Expected result:**

All the test results are OK.

**Test result(s)**

Measurement record 1:

Requirement	Result OK or NOK
The logic of the automatic search function shall be as follows: If any services are detected during the automatic search the current service list shall be replaced by the new service list. If no services are detected during the automatic search the current service list shall be kept or deleted.	
After automatic channel search the	



NorDig

	channel lists do not contain duplicated services.	
	Measurement record 2 is found on next page.	
<b>Conformity</b>	<input type="checkbox"/> <b>OK Fault</b> <input type="checkbox"/> Major <input type="checkbox"/> Minor, define fail reason in comments	
<b>Comments</b>	If possible describe if fault can be fixed with software update: <input type="checkbox"/> <b>YES</b> <input type="checkbox"/> <b>NO</b> Describe more specific faults and/or other information	
<b>Date</b>		<b>Sign</b>

Test point	Channel A, f = 474 MHz			Channel B, f = 690 MHz			Required $\Delta S$ [%]	Required $\Delta Q$ [%]	Receiver channel choice	Expected channel choice	Result OK/NOK	Reference conditions in flowchart [1] Annex D
	Initial signal level [dBm]	Initial CNR [dB]	Additional BER Impairment	Initial signal level [dBm]	Initial CNR [dB]	Additional BER Impairment						
1	-60	no AWGN	None	-60	no AWGN	None	<10	<10		A or B		1,2,3,5,6 or 7
2	-50	no AWGN	None	-65	no AWGN	None	>10	<20		A		1 or 8
3	-65	no AWGN	None	-50	no AWGN	None	>10	<20		B		4 or 5
4	-61	CNR@QMP2+1dB	None	-60	CNR@QMP2+0.5dB	None	<10	<20		A		3
5	-60	CNR@QMP2+0.5dB	None	-61	CNR@QMP2+1dB	None	<10	<20		B		7
6	-61	no AWGN	None	-60	CNR@QMP2+1dB	None	<10	>20		A		2
7	-60	CNR@QMP2+1dB	None	-61	no AWGN	None	<10	>20		B		6
8	-50	no AWGN	None	-65	CNR@QMP2+1dB	None	>10	>20		A		1
9	-65	CNR@QMP2+1dB	None	-50	no AWGN	None	>10	>20		B		5
10	-50	no AWGN	A BER>B BER	-65	no AWGN	A BER>B BER	>10	<20		A		8
11	-65	no AWGN	A BER<B BER	-50	no AWGN	A BER<B BER	>10	<20		B		4
12	-60	no AWGN	A BER<B BER	-60	no AWGN	A BER<B BER	<10	>20		A		1 or 2
13	-60	no AWGN	A BER>B BER	-60	no AWGN	A BER>B BER	<10	>20		B		5 or 6

Table 19 Measurement record 2 for test Task 3:10.

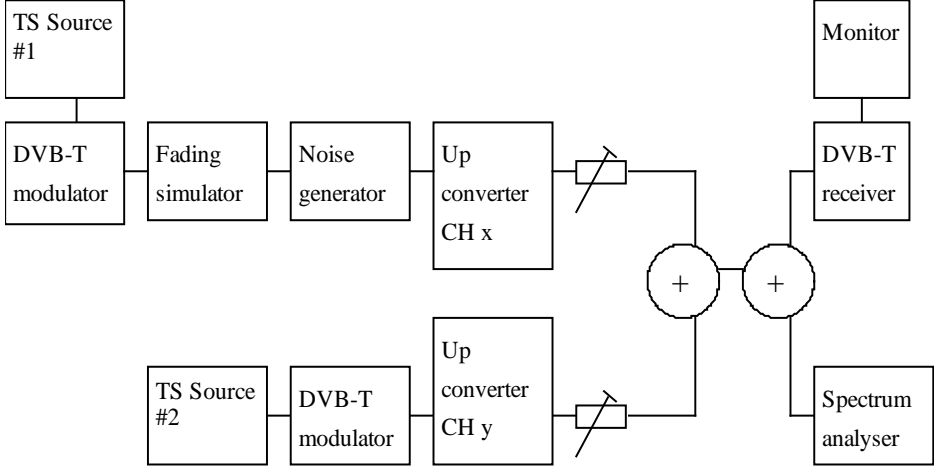
<b>Test Case</b>	<b>Task 3:11 Tuning/Scanning: Automatic channel search for different service bouquets</b>																			
<b>Section</b>	NorDig Unified 3.4.4.4																			
<b>Requirement</b>	<p>The IRD shall provide an automatic search that finds all of the multiplexes and services in the whole (supported) frequency range, see NorDig specification. The logic of the automatic search function shall be as follows:</p> <p style="padding-left: 40px;">If any services are detected during the automatic search the current service list shall be replaced by the new service list.</p> <p style="padding-left: 40px;">If no services are detected during the automatic search the current service list shall be kept or deleted.</p> <p>The IRD shall only display a service once in the service list (i.e. avoiding duplicate of the same services), even if the same service (same triplet original_network_id, transport_stream_id and service_id) is received from multiple transmitters. If the same service can be received from several transmitters, the one with best reception quality shall be selected. The criteria for selection of the best received service (i.e. best reception quality) shall be based on the combination of the signal strength and signal quality according to NorDig Specification.</p>																			
<b>IRD profile(s)</b>	Basic, IRD, DVB-T																			
<b>Test procedure</b>	<p><b>Purpose of test:</b> To verify the best service selection in automatic channel search when the content of the transport streams are different on several transmitters.</p> <p><b>Equipment:</b></p>  <table border="1" data-bbox="395 1713 1332 2038"> <tr> <td data-bbox="395 1713 861 2038"> <p><b>Channel X</b>  <b>TS source #1</b>  <b>ONID=8945</b>  <b>Network ID=<u>1000</u></b>  <b>Network Name=Net1</b>  <b>TSID=100</b>  <b>Services</b>  <table border="1"> <thead> <tr> <th>Name</th> <th>SID</th> <th>Logic</th> <th>Ch No</th> </tr> </thead> <tbody> <tr> <td>S1</td> <td>1</td> <td>1</td> <td></td> </tr> </tbody> </table> </p> </td> <td data-bbox="861 1713 1332 2038"> <p><b>Channel Y</b>  <b>TS source #2</b>  <b>ONID=8945</b>  <b>Network ID=<u>2000</u></b>  <b>Network Name=Net2</b>  <b>TSID=100</b>  <b>Services</b>  <table border="1"> <thead> <tr> <th>Name</th> <th>SID</th> <th>Logic</th> <th>Ch No</th> </tr> </thead> <tbody> <tr> <td>S1</td> <td>1</td> <td>1</td> <td></td> </tr> </tbody> </table> </p> </td> </tr> </table>		<p><b>Channel X</b>  <b>TS source #1</b>  <b>ONID=8945</b>  <b>Network ID=<u>1000</u></b>  <b>Network Name=Net1</b>  <b>TSID=100</b>  <b>Services</b>  <table border="1"> <thead> <tr> <th>Name</th> <th>SID</th> <th>Logic</th> <th>Ch No</th> </tr> </thead> <tbody> <tr> <td>S1</td> <td>1</td> <td>1</td> <td></td> </tr> </tbody> </table> </p>	Name	SID	Logic	Ch No	S1	1	1		<p><b>Channel Y</b>  <b>TS source #2</b>  <b>ONID=8945</b>  <b>Network ID=<u>2000</u></b>  <b>Network Name=Net2</b>  <b>TSID=100</b>  <b>Services</b>  <table border="1"> <thead> <tr> <th>Name</th> <th>SID</th> <th>Logic</th> <th>Ch No</th> </tr> </thead> <tbody> <tr> <td>S1</td> <td>1</td> <td>1</td> <td></td> </tr> </tbody> </table> </p>	Name	SID	Logic	Ch No	S1	1	1	
<p><b>Channel X</b>  <b>TS source #1</b>  <b>ONID=8945</b>  <b>Network ID=<u>1000</u></b>  <b>Network Name=Net1</b>  <b>TSID=100</b>  <b>Services</b>  <table border="1"> <thead> <tr> <th>Name</th> <th>SID</th> <th>Logic</th> <th>Ch No</th> </tr> </thead> <tbody> <tr> <td>S1</td> <td>1</td> <td>1</td> <td></td> </tr> </tbody> </table> </p>	Name	SID	Logic	Ch No	S1	1	1		<p><b>Channel Y</b>  <b>TS source #2</b>  <b>ONID=8945</b>  <b>Network ID=<u>2000</u></b>  <b>Network Name=Net2</b>  <b>TSID=100</b>  <b>Services</b>  <table border="1"> <thead> <tr> <th>Name</th> <th>SID</th> <th>Logic</th> <th>Ch No</th> </tr> </thead> <tbody> <tr> <td>S1</td> <td>1</td> <td>1</td> <td></td> </tr> </tbody> </table> </p>	Name	SID	Logic	Ch No	S1	1	1				
Name	SID	Logic	Ch No																	
S1	1	1																		
Name	SID	Logic	Ch No																	
S1	1	1																		

<b>S2</b>	<b>2</b>	<b>2</b>	<b>S5</b>	<b>5</b>	<b>2</b>
<b>S3</b>	<b>3</b>	<b>3</b>	<b>S6</b>	<b>6</b>	<b>6</b>
<b>S4</b>	<b>4</b>	<b>4</b>			

The TS configuration idea in this test is that on terrestrial network there is possibility to receive several transmitters simultaneously. These transmitters can have partially same content (nationwide services) and partially different content (regionwide services). It is the ON\_id, TS\_id and Service\_id which define a service unique. The Network\_id can be analysed to distinguish the differenciens in the TS. Therefore, it is important that the receiver can in automatic channel search choose the services which have the best reception quality and even find the regionwide services.

Channels x and y shall not be equal.

**Test procedure:**

This test procedure tests combination of the signal level and reception quality.

1. Configure transport streams and setup the instruments. Use DVB-T mode 8k 64QAM R=2/3 Δ/Tu=1/8.
2. Set the signal level of the carrier CH x to a signal level which is about 5dB **higher** than the signal level of the carrier CH y. Both signal levels shall correspond good reception quality (no errors in decoded video).
3. Add noise on carrier CH x to a level that the QMP1 is fulfilled.
4. Perform automatic channel search. The logic of the automatic search function shall be as follows:
  - If any services are detected during the automatic search the current service list shall be replaced by the new service list.
  - If no services are detected during the automatic search the current service list shall be kept or deleted.
5. Check that channel list has services configured in transport streams.

After performing the test the channel list shall be as below:

Position	Service	Channel
1	S1	Y
2	S5/S2 *	Y/X
3	S3	X
4	S4	X
6	S6	Y
7	S2/S5 *	X/Y

\*) Note that order of the services S2 and S5 on the channel list can be chosen by the manufacture. It's highly recommended that the S5 (service without visible errors) is stored in position 2 and the S2 (service with visible errors) is stored in position 7. And generally it is recommended that service detected by the receiver as "better" service is stored in that position which is signalled in Logic Channel No and the other services with same Logic Ch No stored later in the list).

**Expected result:**

All the tests are OK.

**Test result(s)**

Measurement record:

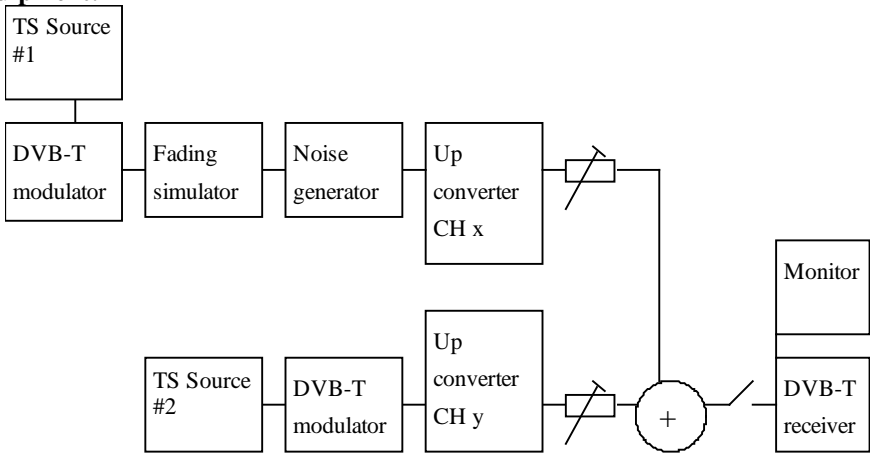

	Requirement	Result OK or NOK
	After automatic channel search the channel lists does not contain duplicated services.	
	The channel list is as defined in test procedure.	
<b>Conformity</b>	<input type="checkbox"/> OK Fault <input type="checkbox"/> Major <input type="checkbox"/> Minor, define fail reason in comments	
<b>Comments</b>	If possible describe if fault can be fixed with software update: <input type="checkbox"/> YES <input type="checkbox"/> NO Describe more specific faults and/or other information	
<b>Date</b>		<b>Sign</b>

<b>Test Case</b>	<b>Task 3:12 Tuning/Scanning Procedures: Manual Channel Search</b>																	
<b>Section</b>	NorDig Unified 3.4.4.5																	
<b>Requirement</b>	In addition to the automatic search, it shall be possible to perform a manual search where the channel id(or frequency) is entered by the end user. The IRD shall tune to this channel, search all available DVB-Tmodes, add all new services and replace existing equal services2 (same triplet original_network_id,transport_stream_id and service_id) in the service list (without considering any quality criteria).																	
<b>IRD profile(s)</b>	Basic, IRD, DVB-T																	
<b>Test procedure</b>	<p><b>Purpose of test:</b> To verify the functionality of the manual channel search.</p> <p><b>Equipment:</b></p> 																	
	<p><b>Channel X</b>  <b>TS source #1</b>  <b>ONID=8945</b>  <b>Network ID=<u>1000</u></b>  <b>Network Name=Net1</b>  <b>TSID=100</b>  <b>Services</b></p> <table border="1"> <thead> <tr> <th>Name</th> <th>SID</th> <th>Logic</th> <th>Ch No</th> </tr> </thead> <tbody> <tr> <td>S1</td> <td>1</td> <td></td> <td>1</td> </tr> </tbody> </table>	Name	SID	Logic	Ch No	S1	1		1	<p><b>Channel Y</b>  <b>TS source #2</b>  <b>ONID=8945</b>  <b>Network ID=<u>2000</u></b>  <b>Network Name=Net2</b>  <b>TSID=100</b>  <b>Services</b></p> <table border="1"> <thead> <tr> <th>Name</th> <th>SID</th> <th>Logic</th> <th>Ch No</th> </tr> </thead> <tbody> <tr> <td>S1</td> <td>1</td> <td></td> <td>1</td> </tr> </tbody> </table>	Name	SID	Logic	Ch No	S1	1		1
Name	SID	Logic	Ch No															
S1	1		1															
Name	SID	Logic	Ch No															
S1	1		1															

<b>S2</b>	<b>2</b>	<b>2</b>	<b>S5</b>	<b>5</b>	<b>2</b>
<b>S3</b>	<b>3</b>	<b>3</b>	<b>S6</b>	<b>6</b>	<b>6</b>
<b>S4</b>	<b>4</b>	<b>4</b>			

The TS configuration idea in this test is that on terrestrial network there is possibility to receive several transmitters simultaneously. These transmitters can have partially same content (nationwide services) and partially different content (regionwide services). It is the ON\_id, TS\_id and Service\_id which define a service unique. The Network\_id can be analysed to distinguish the differences in the TS. Furthermore, regional services may have same LCN which results to a conflict. Finally, it is important that user can force the receiver to search all services within TS by selecting the channel number and install services from that TS on channel list without any quality criteria.

**Test procedure:**

1. Configure transport streams and setup the instruments.
2. Check that channel list is empty. If it is not empty delete all services.
3. Attenuate the carrier on CH x to a signal level that it is not possible to receive.
4. Perform automatic channel search.
5. Check that the services S1, S5 and S6 on channel list are from carrier on CH y by attenuating the carrier on CH y. If the received channel is correct the services S1, S5 and S6 shall be frozen when the signal level is too low. Restore the attenuation level back to same level it was before you started to change it.
6. Decrease the attenuation of the carrier on CH x to a signal level that the carrier is possible to be received. Add noise on carrier CH x to a level that QMP1 is fulfilled.
7. Perform manual channel search. Check that the carrier, which is wanted to be searched, is given in channel number format.
8. Fill in the measurement record.
9. Check that services S1, S2, S3 and S4 on channel list are from carrier on CH x by attenuating the carrier on CH x. If the received channel is correct the services S1, S2, S3 and S4 shall be frozen when the signal level is too low. Restore the attenuation level back to same level it was before you started to change it.
10. Check that service S1 is not listed twice on channel list.

The channel list shall look like this after performing this procedure:

Position	Service	Channel
1	S1	X
2	S2/S5 *	X/Y
3	S3	X
4	S4	X
6	S6	Y
7	S5/S2 *	Y/X

\*) Note that order of the services S2 and S5 can be chosen by the manufacturer. It is highly recommended that the services found in the last manual channel search are stored in the service list according to their signalling.

In terrestrial networks in a case where received services have equal ON\_id, TS\_id and LCN, but Network\_id and Service\_id differ most probably means regional variations of the same service. In that case it is highly recommended to move already stored service to an other position in the channel list and store the service found in the last manual channel search to position signalled in the LCN.

**Expected result:**

All test results shall be OK.

**Test result(s)**

Measurement record:

	<b>Requirement</b>	<b>Result OK or NOK</b>
	Manual channel search can be performed successfully by only entering channel number	
	The channel list is as defined in test procedure	
	Service S1 in only listed once on the channel list	
<b>Conformity</b>	<input type="checkbox"/> OK Fault <input type="checkbox"/> Major <input type="checkbox"/> Minor, define fail reason in comments	
<b>Comments</b>	If possible describe if fault can be fixed with software update: <input type="checkbox"/> YES <input type="checkbox"/> NO Describe more specific faults and/or other information	
<b>Date</b>		<b>Sign</b>

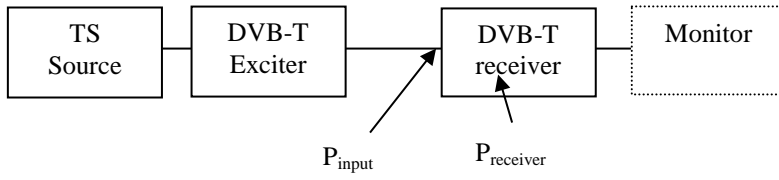
<b>Test Case</b>	<b>Task 3:13 Verification of Signal Strength Indicator (SSI)</b>
<b>Section</b>	NorDig Unified 3.4.4.6
<b>Requirement</b>	<p>The NorDig IRD shall be provided with a signal strength indicator (SSI). The value for the SSI shall be referred to the IRD RF signal input.</p> <p>The NorDig IRD shall be able to determine signal strength within a range starting from 15 dB lower than the reference signal level defined in NorDig Specification and up to 35dB above that value or maximum signal input level defined in NorDig Specification.</p> <p>The absolute accuracy shall be <math>\pm 5</math> dB at RF signal input levels -80 dBm to -60 dBm and <math>\pm 7</math> dB for RF signal input levels higher than -60 dBm.</p> <p>The relative accuracy should be <math>\pm 3</math> dB between center frequencies within one frequency band, e.g. VHF Band III or UHF Band IV/V, supported by the receiver.</p> <p>Signal strength indicator shall have a relative numerical value within a range from 0% to 100% and with a resolution of 1%.</p> <p>The signal strength indicator shall be updated regularly once per second.</p>
<b>IRD profile(s)</b>	Basic, IRD, DVB-T
<b>Test procedure</b>	<p><b>Purpose of test:</b> To verify the correct functionality of the signal strength indicator.</p> <p><b>Equipment:</b></p>  <pre> graph LR     TS[TS Source] --&gt; Exciter[DVB-T Exciter]     Exciter --&gt; Receiver[DVB-T receiver]     Receiver --&gt; Monitor[Monitor]     </pre> <p>Gaussian channel profile used i.e. no need for fading simulator.</p> <p>In this test, the signal input level <math>P_{input\ level}</math> at the RF input must be known.</p>

The test procedure assumes that the  $P_{\text{receiver}}$  is not displayed by the receiver. If the  $P_{\text{receiver}}$  is displayed by the receiver this test procedure can be simplified.

**Test procedure:**

Verify SSI values:

1. Set-up the test system
2. Determine the attenuation of the test system so that the signal input level at the receiver input is known in the measured frequencies.
3. Use the following DVB-T mode {8K, 64QAM, R=2/3,  $\Delta/T_U=1/8$ } and signal bandwidth of 8MHz.
4. Set the up-converter to frequency 474MHz (K21).
5. Set the signal level into the receiver according to measurement record 1.
6. Do the channel search.
7. Fill in the SSI value displayed by the receiver in the measurement record 1.
8.  $SSI_{\text{min}}$  and  $SSI_{\text{max}}$  defines the allowed range of the displayed value.
9. Fill in the measurement record 1 OK or NOK depending of the displayed SSI value.
10. Measure rest of the frequencies and DVB-T modes.
11. Fill in the measurement record 1.

Verify the relative error:

1. Convert the displayed SSI values to  $P_{\text{receiver}}$  [dBm] values. Select the correct formula for calculating  $P_{\text{receiver}}$  according to the displayed SSI value as shown below:

$$P_{\text{receiver}} = (3/2) * (SSI - 90) + 20 + P_{\text{reference}} \quad \text{if } 90 \leq SSI < 100$$

$$P_{\text{receiver}} = (1/4) * (SSI - 10) + P_{\text{reference}} \quad \text{if } 10 \leq SSI < 90$$

$$P_{\text{receiver}} = (3/2) * SSI - 15 + P_{\text{reference}} \quad \text{if } 0 \leq SSI < 10$$

2. Fill in the dBm values in the measurement record 2 for corresponding signal input level.
3. Calculate the average value of the  $P_{\text{receiver}}$  values in three frequencies within a frequency band.
4. Verify the calculated  $P_{\text{receiver}}$  [dBm] values are within  $\pm 3$  dB from the average value.
5. Fill in the measurement record 2 OK or NOK

**Expected result:**

All the measurements shall be OK.

The signal strength indicator value is updated regularly once per second.

**Test result(s)**

Measurement record 1:

8k 64QAM R2/3 G1/8 8MHz, $P_{\text{reference}}=-80\text{dBm}$ , $f=666\text{MHz}$				
$P_{\text{input level}}$ [dBm]	SSI [%]	$SSI_{\text{min}}$ [%]	$SSI_{\text{max}}$ [%]	NOK or OK
-40		99	100	
-50		92	100	
-60		70	93	
-70		30	70	
-80		7	30	
-95		0	5	

8k 64QAM R2/3 G1/8 8MHz, $P_{\text{reference}}=-80\text{dBm}$ , $f=474\text{MHz}$				
$P_{\text{input level}}$ [dBm]	SSI [%]	$SSI_{\text{min}}$ [%]	$SSI_{\text{max}}$ [%]	NOK or OK
-40		99	100	
-50		92	100	
-60		70	93	
-70		30	70	
-80		7	30	
-95		0	5	

8k 64QAM R2/3 G1/8 8MHz, $P_{\text{reference}}=-80\text{dBm}$ , $f=786\text{MHz}$				
$P_{\text{input level}}$ [dBm]	SSI [%]	$SSI_{\text{min}}$ [%]	$SSI_{\text{max}}$ [%]	NOK or OK
-40		99	100	
-50		92	100	
-60		70	93	
-70		30	70	
-80		7	30	
-95		0	5	

8k 64QAM R2/3 G1/8 7MHz, $P_{\text{reference}}=-80\text{dBm}$ , $f=177.5\text{MHz}$				
$P_{\text{input level}}$ [dBm]	SSI [%]	$SSI_{\text{min}}$ [%]	$SSI_{\text{max}}$ [%]	NOK or OK
-40		99	100	
-50		92	100	
-60		70	93	
-70		30	70	
-80		7	30	
-95		0	5	

8k 64QAM R2/3 G1/8 7MHz, $P_{\text{reference}}=-80\text{dBm}$ , $f=198.5\text{MHz}$				
$P_{\text{input level}}$ [dBm]	SSI [%]	$SSI_{\text{min}}$ [%]	$SSI_{\text{max}}$ [%]	NOK or OK
-40		99	100	
-50		92	100	
-60		70	93	
-70		30	70	
-80		7	30	
-95		0	5	

8k 64QAM R2/3 G1/8 7MHz, $P_{\text{reference}}=-80\text{dBm}$ , $f=226.5\text{MHz}$				
$P_{\text{input level}}$ [dBm]	SSI [%]	$SSI_{\text{min}}$ [%]	$SSI_{\text{max}}$ [%]	NOK or OK
-40		99	100	
-50		92	100	
-60		70	93	
-70		30	70	
-80		7	30	
-95		0	5	

8k 64QAM R3/4 G1/4 8MHz, $P_{\text{reference}}=-78\text{dBm}$ , $f=666\text{MHz}$				
$P_{\text{input level}}$ [dBm]	SSI [%]	$SSI_{\text{min}}$ [%]	$SSI_{\text{max}}$ [%]	NOK or OK
-40		97	100	
-50		91	100	
-60		62	92	
-70		22	62	
-80		5	22	
-95		0	3	

Measurement record 2:

P <sub>input level</sub> [dBm]	P <sub>receiver</sub> [dBm] @474MHz	P <sub>receiver</sub> [dBm] @666MHz	P <sub>receiver</sub> [dBm] @786MHz	Average	NOK or OK
-40					
-50					
-60					
-70					
-80					
-95					

P <sub>input level</sub> [dBm]	P <sub>receiver</sub> [dBm] @177.5MHz	P <sub>receiver</sub> [dBm] @198.5MHz	P <sub>receiver</sub> [dBm] @226.5MHz	Average	NOK or OK
-40					
-50					
-60					
-70					
-80					
-95					

**Conformity**  OK Fault  Major  Minor, define fail reason in comments

**Comments** If possible describe if fault can be fixed with software update:  YES  NO  
Describe more specific faults and/or other information

**Date** \_\_\_\_\_ **Sign** \_\_\_\_\_

<b>Test Case</b>	<b>Task 3:14 Verification of Signal Quality Indicator (SQI)</b>
<b>Section</b>	NorDig Unified 3.4.4.7
<b>Requirement</b>	<p>The NorDig IRD shall (1) be provided with a signal quality indicator (SQI). The value for the SQI shall be referred to the IRD RF signal input.</p> <p>The absolute accuracy of the C/N value shall be of ±1dB for C/N values of 17 dB to 27 dB at the IRD RF signal input.</p> <p>The signal quality indicator shall have a relative numerical value within a range from 0% to 100% and with a resolution of 1%.</p> <p>The signal quality indicator shall be updated regularly once per second.</p>
<b>IRD profile(s)</b>	Basic, IRD, DVB-T
<b>Test procedure</b>	<p><b>Purpose of test:</b> To verify the correct functionality of the signal quality indicator.</p> <p><b>Equipment:</b></p>

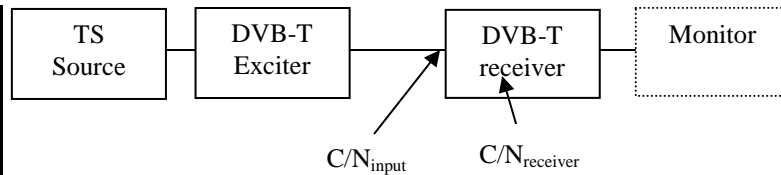

Gaussian channel profile used i.e. no need for fading simulator.

$C/N_{input}$  refers to generated DVB-T signal  $C/N$  at receiver input.

$C/N_{receiver}$  refers to  $C/N$  determined by the receiver under test.

$$C/N_{rel} = C/N_{input} - C/N_{NorDigP1}$$

$C/N_{NorDigP1}$  refers to table 3.10 at [1].

First we need to define the required  $C/N_{input}$  for the QMP2. After that we know what is the expected rescale of BER before RS. The slope of the curve for BER before RS as a function of the required  $C/N_{input}$  should be equal independently of the receiver. Using that knowledge  $SQI_{min}$  and  $SQI_{max}$  can be calculated.

#### Test procedure:

1. Set up the test instruments
2. Use the following DVB-T mode {8K, 64QAM, R=2/3,  $\Delta/T_U=1/8$ } and signal bandwidth 8MHz.
3. Set the up-converter to frequency 666MHz (K45).
4. Do the channel search.
5. Determine the lowest required  $C/N$  by adjusting the  $C/N_{input}$  until the quality measurement procedure 2 error free video is fulfilled.
6. Fill in the measurement record 1 the  $C/N_{input}$  value defined as  $C/N_{receiver}$ . Later in this test procedure the value  $C/N_{receiver}$  is used for rescaling of the  $BER\_SQI_{min}$  and  $BER\_SQI_{max}$  values.
7. Decrease the  $C/N_{input}$  in 1dB step starting from highest value in measurement record 2.
8. Fill in the displayed SQI in the measurement record 2.
9. Repeat the test for the DVB-T mode {8K, 64QAM, R=3/4,  $\Delta/T_U=1/4$ } and signal bandwidth 8MHz.
10. Do the calculations in the rest of the test procedure.

Calculation for minimum SQI value:

11. Calculate  $C/N_{rel\_error\_min}$  for all  $C/N_{input}$  values using formula  

$$C/N_{rel\_error\_min} = C/N_{rel} - 1$$
12. Calculate  $CNR\_SQI_{min}$  for all  $C/N_{input}$  values using formula  

$$CNR\_SQI_{min} = 0, \quad \text{if } C/N_{rel\_error\_min} < -7 \text{ dB}$$

$$CNR\_SQI_{min} = [(C/N_{rel\_error\_min} - 3)/10] + 1, \quad \text{if } -7 \text{ dB} \leq C/N_{rel\_error\_min} < 3 \text{ dB}$$

$$CNR\_SQI_{min} = 1, \quad \text{if } C/N_{rel\_error\_min} \geq 3 \text{ dB}$$
13. Calculate  $BER\_SQI_{min}$  for all  $C/N_{input}$  values using formula  

$$BER\_SQI_{min} = 19.0 * [C/N_{rel\_error\_min} - (C/N_{receiver} - X) + 3.6],$$

where  $X = 16.2$  (64QAM R2/3)  
 $X = 17.4$  (64QAM R3/4)

if resulted  $BER\_SQI_{min} < 20$  then set  $BER\_SQI_{min} = 0$   
 if resulted  $BER\_SQI_{min} > 100$  then set  $BER\_SQI_{min} = 100$ .

14. Calculate  $SQI_{min}$  using formula  
 $SQI_{min} = CNR\_SQI_{min} * BER\_SQI_{min}$
15. Fill in the  $SQI_{min}$  values in the measurement procedure 2.

Calculation for maximum SQI value:

16. Calculate  $C/N_{rel\_error\_max}$  for all  $C/N_{input}$  values using formula  
 $C/N_{rel\_error\_max} = C/N_{rel} + 1$
17. Calculate  $CNR\_SQI_{max}$  for all  $C/N_{input}$  values using formula  
 $CNR\_SQI_{max} = 0$ , if  $C/N_{rel\_error\_max} < -7$  dB  
 $CNR\_SQI_{max} = [(C/N_{rel\_error\_max} - 3)/10] + 1$ , if  $-7$  dB  $\leq C/N_{rel\_error\_max} < 3$  dB  
 $CNR\_SQI_{max} = 1$ , if  $C/N_{rel\_error\_max} \geq 3$  dB
18. Calculate  $BER\_SQI_{max}$  for all  $C/N_{input}$  values using formula  
 $BER\_SQI_{max} = 19.0 * [C/N_{rel\_error\_max} - (C/N_{receiver} - X) + 3.6]$ ,  
 where  $X = 16.2$  (64QAM R2/3)  
 $X = 17.4$  (64QAM R3/4)  
 if resulted  $BER\_SQI_{max} < 20$  then set  $BER\_SQI_{max} = 0$   
 if resulted  $BER\_SQI_{max} > 100$  then set  $BER\_SQI_{max} = 100$ .
19. Calculate  $SQI_{max}$  using formula  
 $SQI_{max} = CNR\_SQI_{max} * BER\_SQI_{max}$
20. Fill in the  $SQI_{max}$  values in the measurement procedure 2.

**Expected result:**

All the test result are OK.  
 The signal quality indicator is updated regularly once per second.

**Test result(s)**

Measurement record 1:

DVB-T mode	Required $C/N_{receiver}$ [dB] (60 sec error free video)
8k 64QAM R2/3 G1/8 8MHz	
8k 64QAM R3/4 G1/4 8MHz	

Measurement record 2:

8k 64QAM R2/3 G1/8 8MHz, $C/N_{NorDigP1} = 18.7$ dB				
$C/N_{input}$	SQI[%]	$SQI_{min}$ [%]	$SQI_{max}$ [%]	NOK or OK
27				
26				
25				
24				
23				
22				
21				
20				
19				
18				
17				

8k 64QAM R3/4 G1/4 8MHz, $C/N_{NorDigP1} = 20.2$ dB				
$C/N_{input}$	SQI[%]	$SQI_{min}$ [%]	$SQI_{max}$ [%]	NOK or OK
27				



26				
25				
24				
23				
22				
21				
20				
19				
18				
17				

Example for calculating  $SQI_{min}$  and  $SQI_{max}$  values for 64QAM R2/3 when  $C/N_{receiver} = 15.0dB$  at QMP2 resulting to  $C/N_{receiver} - X = -1.2dB$  where  $X = 16.2$ :

CNReceiver @QMP2=   
 (C/Nreceiver-16.2) @QMP2= -1.2  
 64QAM R2/3 C/NNorDigP1= 18,7

C/N input	C/Nrel	C/N error Min	C/Nrel error Min	CNR_SQI Min	BER_SQI Min	C/N error Max	C/Nrel error Max	CNR_SQI Max	BER_SQI Max	SQI Min	SQI Max	SQI measured 64QAM R2/3	OK or NOK
15	-3,7	-1	-4,7	0,23	0	1	-2,7	0,43	40	0	18		
16	-2,7	-1	-3,7	0,33	21	1	-1,7	0,53	59	6	32		
16,2	-2,5	-1	-3,5	0,35	25	1	-1,5	0,55	63	8	35		
17	-1,7	-1	-2,7	0,43	40	1	-0,7	0,63	78	17	50		
18	-0,7	-1	-1,7	0,53	59	1	0,3	0,73	97	31	71		
19	0,3	-1	-0,7	0,63	78	1	1,3	0,83	100	49	83		
20	1,3	-1	0,3	0,73	97	1	2,3	0,93	100	70	93		
21	2,3	-1	1,3	0,83	100	1	3,3	1,00	100	83	100		
22	3,3	-1	2,3	0,93	100	1	4,3	1,00	100	93	100		
23	4,3	-1	3,3	1,00	100	1	5,3	1,00	100	100	100		
24	5,3	-1	4,3	1,00	100	1	6,3	1,00	100	100	100		
25	6,3	-1	5,3	1,00	100	1	7,3	1,00	100	100	100		
26	7,3	-1	6,3	1,00	100	1	8,3	1,00	100	100	100		
27	8,3	-1	7,3	1,00	100	1	9,3	1,00	100	100	100		

**Conformity**  OK Fault  Major  Minor, define fail reason in comments

**Comments** If possible describe if fault can be fixed with software update:  YES  NO  
 Describe more specific faults and/or other information

**Date** \_\_\_\_\_ **Sign** \_\_\_\_\_

<b>Test Case</b>	<b>Task 3:15 Changes In Modulation Parameters</b>
<b>Section</b>	NorDig Unified 3.4.5
<b>Requirement</b>	The terrestrial NorDig IRD should recover from changes in modulation parameters at the end of a superframe without a break in the received DVB-T signal and output an error free TS. This should take less than one second for any change. The Nordig IRD should be able to detect a change of modulation parameters signalled in the TPS data of the DVB-T signal, in order to reduce the recovery time.  The terrestrial NorDig IRD should recover from changes in modulation parameters occurring at any time followed by a break in the received DVB-T signal and output an error free TS. This should take less than four seconds for any change.
<b>IRD profile(s)</b>	Basic, IRD, DVB-T
<b>Test procedure</b>	<b>Purpose of test:</b> To verify that receiver can recover from changes in modulation parameter occurring at any time followed by a break in the received DVB-T signal and output an error free TS.

**Equipment:**

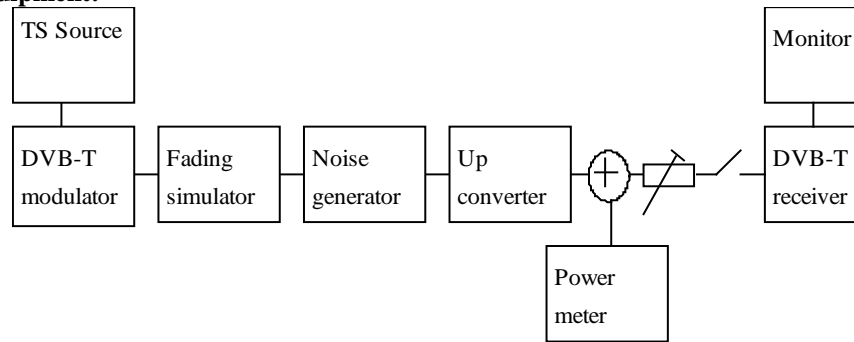

The DVB-T modulator shall have a bitrate adaptation to test this test, or, alternatively the TS source shall have capability to change the output transport stream bitrate to correspond the DVB-T mode. See bitrates in chapter 2.3.3.

**Test procedure:**

1. Set up the instruments.
2. Use frequency 666 MHz (K45).
3. Set the RF input level to receiver to  $-50\text{dBm}$ .
4. Set up DVB-T mode 8k 64QAM R3/4 G1/4 and signal bandwidth 8 MHz in DVB-T modulator.
5. Verify that the switch is closed.
6. Check picture quality using the quality measurement procedure 1 (QMP1).
7. Open the switch to break the received RF signal
8. Change DVB-T mode to the next mode in the measurement record
9. Wait for the DVB-T modulator output to become valid and stable with this new mode (this time is modulator specific)
10. Close the switch to enable the RF signal to the receiver and record the time taken to achieve QMP1
11. Fill in the measurement record.
12. Repeat steps 7-11 for the rest of the DVB-T modes defined in the measurement record.

**Expected result:**

The receiver can recover from changes in modulation parameter occurring at any time followed by a break in the received DVB-T signal and output an error free TS within 4 seconds (excluding modulator stabilization time) without requiring a channel scan.

**Test result(s)**

Measurement record:

Mode	NOK or OK
8k 64QAM R3/4 G1/4	
8k 64QAM R2/3 G1/4	
8k 64QAM R2/3 G1/8	
8k 16QAM R2/3 G1/8	
8k QPSK R1/2 G1/8	
2k QPSK R1/2 G1/16	
2k 16QAM R2/3 G1/32	

**Conformity**

OK Fault  Major  Minor, define fail reason in comments

**Comments**

If possible describe if fault can be fixed with software update:  YES  NO  
Describe more specific faults and/or other information

<i>Date</i>		<i>Sign</i>

<i>Test Case</i>	<b>Task 3:16 RF input connector</b>
<i>Section</i>	NorDig Unified 3.4.6
<i>Requirement</i>	The NorDig IRD shall have one input tuner connector, type: IEC female in accordance with IEC 61169-2, part 2 [28]. The input impedance shall be 75 ohm.
<i>IRD profile(s)</i>	Basic, IRD, DVB-T
<i>Test procedure</i>	<p><b>Purpose of test:</b> To verify that the receiver has a correct input connector for the reception of the DVB-T signals.</p> <p><b>Equipment:</b> No special equipment is required.</p> <p><b>Test procedure:</b> Verify that the RF input connector is accordance the specification IEC 61169-2. (With other words the connector is similar as RF input connector used in TV sets RF input). Verify in the manufacturer's technical specification that the input impedance of the RF input is 75 ohm.</p> <p><b>Expected result:</b> RF input connector is as defined in specification IEC 61169-2 and the input impedance is 75ohm.</p>
<i>Test result(s)</i>	The manufacturer describes his specific setup for the test
<i>Conformity</i>	<input type="checkbox"/> OK Fault <input type="checkbox"/> Major <input type="checkbox"/> Minor, define fail reason in comments
<i>Comments</i>	If possible describe if fault can be fixed with software update: <input type="checkbox"/> YES <input type="checkbox"/> NO Describe more specific faults and/or other information
<i>Date</i>	<i>Sign</i>

<i>Test Case</i>	<b>Task 3:17 RF output connector</b>
<i>Section</i>	NorDig Unified 3.4.7
<i>Requirement</i>	<p>For a NorDig IRDs equipped with a RF bypass (RF<sub>in</sub> - RF<sub>out</sub>), the connector shall be of type: IEC male in accordance with IEC 61169, part 2 [28]. The frequency range for the RF bypass should be from 47 MHz to 862 MHz and the RF bypass gain should be from -1 dB to +3 dB.</p> <p>The RF signals should be bypassed from RF<sub>in</sub> to RF<sub>out</sub> independently from the status of the NorDig IRD (operational or stand by), so that connected equipment (e.g. TV set) can</p>

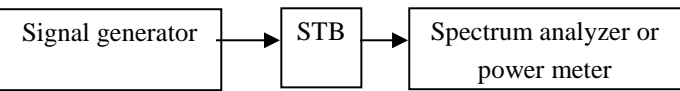
	operate even if the NorDig IRD is in stand by.
<b>IRD profile(s)</b>	Basic, IRD, DVB-T
<b>Test procedure</b>	<p><b>Purpose of test:</b> To check that the receiver has a correct output connector for the loop through of the RF signals. To test the attenuation/gain of the RF loop through for standby and operational modes.</p> <p><b>Equipment:</b></p> <div style="text-align: center;">  <pre> graph LR     A[Signal generator] --&gt; B[STB]     B --&gt; C[Spectrum analyzer or power meter]           </pre> </div> <p><b>Test procedure:</b></p> <ol style="list-style-type: none"> <li>1. Connect signal generator to receiver RF input and spectrum analyser to RF output (may need DC block).</li> <li>2. Set the input level to the receiver -50dBm. Use CW.</li> <li>3. Sweep the frequency of the signal generator from 47 MHz to 869 MHz.</li> <li>4. Measure the attenuation of the loop through over the frequency range.</li> <li>5. Repeat the test for the standby mode.</li> </ol> <p>Verify that the RF output connector is accordance the specification IEC 61169-2.</p> <p><b>Expected result:</b></p> <p>RF output connector is as defined in specification IEC 61169, the attenuation of the loop through shall not be too low or high and the loopthrough works in operational and standby mode.</p>
<b>Test result(s)</b>	
<b>Conformity</b>	<input type="checkbox"/> OK Fault <input type="checkbox"/> Major <input type="checkbox"/> Minor, define fail reason in comments
<b>Comments</b>	If possible describe if fault can be fixed with software update: <input type="checkbox"/> YES <input type="checkbox"/> NO Describe more specific faults and/or other information
<b>Date</b>	<b>Sign</b>

<b>Test Case</b>	<b>Task 3:18 Performance: BER vs C/N verification</b>
<b>Section</b>	NorDig Unified 3.4.10.2
<b>Requirement</b>	Verify the internal BER measurement of the NorDig IRD for objective measurements (QMP3).
<b>IRD profile(s)</b>	Basic, IRD, DVB-T

**Test procedure**

**Purpose of test:**

To check that the internal BER value measured by the receiver to reference BER value in a function of C/N on Gaussian channel is correct.

**Equipment:**

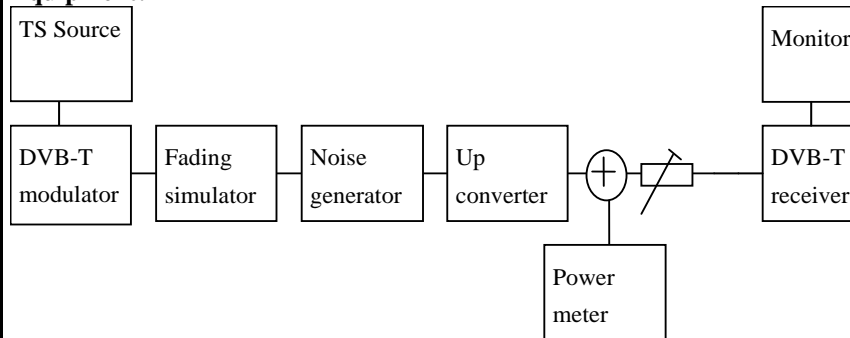

Reference BER in a function of the C/N on Gaussian channel.

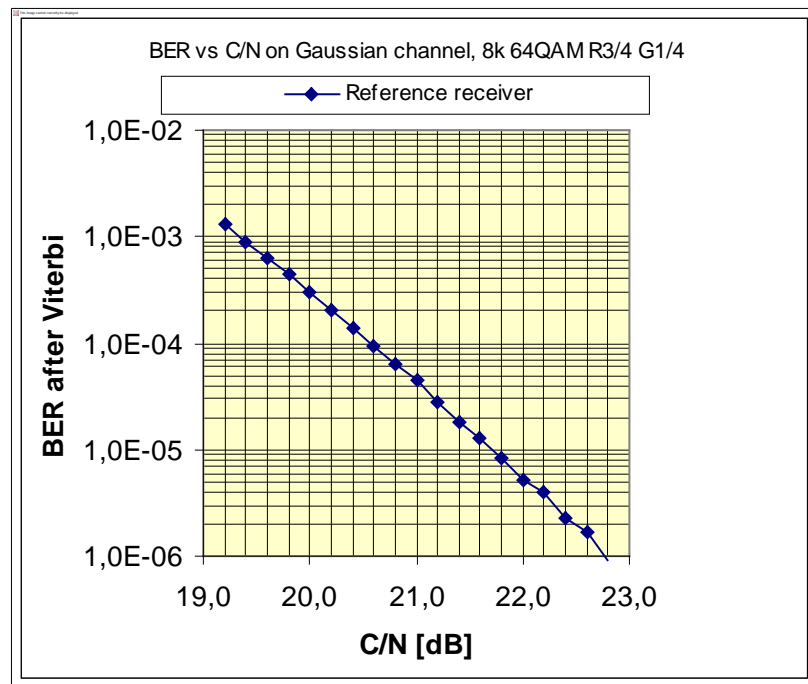

**Test procedure:**

1. Setup the instruments.
2. Use channel 45 and DVB-T mode 8k 64QAM R3/4 G1/4. Set the RF input level to  $-50\text{dBm}$ .
3. Use the quality measurement procedure 2.
4. Compare the BER measured by the receiver to reference BER in a function of the C/N measurement on Gaussian channel.
5. Fill in the BER value in measurement record.
6. Adjust the required C/N that it corresponds BER  $2\text{E-}4$  after viterbi.
7. Decrease the required C/N by 1dB. Check that it corresponds approximately BER  $2\text{E-}3$  after viterbi and QMP1.

**Expected result:**

The measured BER in a function of required C/N shall have the same slope as with the reference BER in a function of required C/N.

	The decrease of the required C/N corresponding BER 2E-4 after Viterbi by 1dB shall result approximately to BER 2E-3 after Viterbi corresponding QMP1.																																																				
<i>Test result(s)</i>	Measurement record: <table border="1" data-bbox="651 405 1078 981" style="margin-left: auto; margin-right: auto;"> <thead> <tr> <th>C/N</th> <th>Reference BER</th> <th>Measured BER</th> </tr> </thead> <tbody> <tr><td>18.0</td><td>-</td><td></td></tr> <tr><td>18.2</td><td>-</td><td></td></tr> <tr><td>18.4</td><td>-</td><td></td></tr> <tr><td>18.6</td><td>-</td><td></td></tr> <tr><td>18.8</td><td>-</td><td></td></tr> <tr><td>19.0</td><td>-</td><td></td></tr> <tr><td>19.2</td><td>-</td><td></td></tr> <tr><td>19.4</td><td>-</td><td></td></tr> <tr><td>19.6</td><td>6.3E-4</td><td></td></tr> <tr><td>20.0</td><td>3.0E-4</td><td></td></tr> <tr><td>20.2</td><td>2.0E-4</td><td></td></tr> <tr><td>20.6</td><td>9.3E-5</td><td></td></tr> <tr><td>21.0</td><td>6.2E-5</td><td></td></tr> <tr><td>21.6</td><td>1.3E-5</td><td></td></tr> <tr><td>22.0</td><td>5.1E-6</td><td></td></tr> <tr><td>22.6</td><td>1.7E-6</td><td></td></tr> </tbody> </table>		C/N	Reference BER	Measured BER	18.0	-		18.2	-		18.4	-		18.6	-		18.8	-		19.0	-		19.2	-		19.4	-		19.6	6.3E-4		20.0	3.0E-4		20.2	2.0E-4		20.6	9.3E-5		21.0	6.2E-5		21.6	1.3E-5		22.0	5.1E-6		22.6	1.7E-6	
C/N	Reference BER	Measured BER																																																			
18.0	-																																																				
18.2	-																																																				
18.4	-																																																				
18.6	-																																																				
18.8	-																																																				
19.0	-																																																				
19.2	-																																																				
19.4	-																																																				
19.6	6.3E-4																																																				
20.0	3.0E-4																																																				
20.2	2.0E-4																																																				
20.6	9.3E-5																																																				
21.0	6.2E-5																																																				
21.6	1.3E-5																																																				
22.0	5.1E-6																																																				
22.6	1.7E-6																																																				
<i>Conformity</i>	<input type="checkbox"/> <b>OK Fault</b> <input type="checkbox"/> Major <input type="checkbox"/> Minor, define fail reason in comments																																																				
<i>Comments</i>	If possible describe if fault can be fixed with software update: <input type="checkbox"/> <b>YES</b> <input type="checkbox"/> <b>NO</b> Describe more specific faults and/or other information																																																				
<i>Date</i>		<i>Sign</i>																																																			

<i>Test Case</i>	<b>Task 3:19 Performance: C/N performance on Gaussian channel</b>
<i>Section</i>	NorDig Unified 3.4.10.3
<i>Requirement</i>	The NorDig IRD shall have a QEF performance for the C/N ratios given in Table 3.9, or better performance.
<i>IRD profile(s)</i>	Basic, IRD, DVB-T
<i>Test procedure</i>	<b>Purpose of test:</b> To test the required C/N for quasi error free reception in Gaussian channel.  <b>Equipment:</b>

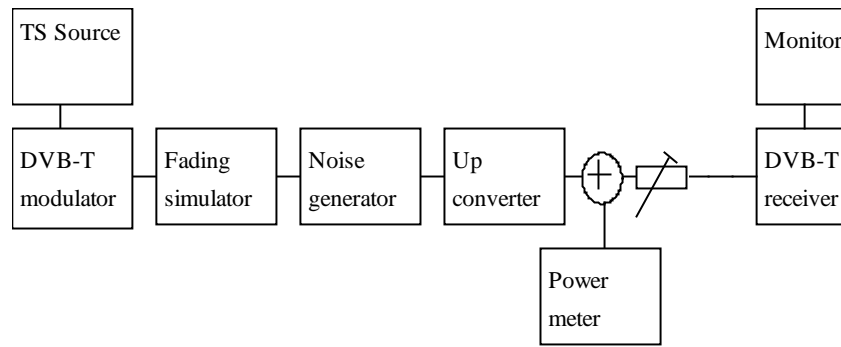

**Test procedure for Gaussian channel:**

16. Set up the test instruments
17. Use the following mode {8K, 64QAM, R=2/3,  $\Delta/T_U=1/8$ }
18. Set the up-converter to channel 21
19. Measure the input level to the attenuator.
20. Determine the attenuation of the attenuator and the cables.
21. Calculate the receiver input signal level and set it to  $-50\text{dBm}$ .
22. Use the value for the required C/N specified for the DVB-T mode in table 3.9.
23. Do the channel search.
24. Increase the C/N from low value to higher value until the quality measurement procedure 2 (QMP2) fulfils.
25. Fill in the measured value in dB in the measurement record.
26. Repeat the test for the rest of the frequencies, signal bandwidths and DVB-T modes defined in the measurement record.

**Expected result:**

The required C/N for quasi error free reception in gaussian channel is less than specified in table 3.9.

<b>Test result(s)</b>	Measurement record: See tables below.
<b>Conformity</b>	<input type="checkbox"/> OK Fault <input type="checkbox"/> Major <input type="checkbox"/> Minor, define fail reason in comments
<b>Comments</b>	If possible describe if fault can be fixed with software update: <input type="checkbox"/> YES <input type="checkbox"/> NO Describe more specific faults and/or other information
<b>Date</b>	<b>Sign</b>



Measurement record:

Signal bandwidth	7 MHz			8 MHz								
Centerfrequency [MHz]	177.5	198.5	226.5	474.0	522.0	570.0	618.0	666.0	714.0	762.0	810.0	858.0
DVB-T mode / Channel Id	K5	K8	K12	K21	K27	K33	K39	K45	K51	K57	K63	K69
8k QPSK R1/2 G1/4												
8k QPSK R2/3 G1/4												
8k QPSK R3/4 G1/4												
8k QPSK R5/6 G1/4												
8k QPSK R7/8 G1/4												
8k 16QAM R1/2 G1/4												
8k 16QAM R2/3 G1/4												
8k 16QAM R3/4 G1/4												
8k 16QAM R5/6 G1/4												
8k 16QAM R7/8 G1/4												
8k 64QAM R1/2 G1/4												
8k 64QAM R2/3 G1/4												
8k 64QAM R2/3 G1/8												
8k 64QAM R3/4 G1/4												
8k 64QAM R5/6 G1/4												
8k 64QAM R7/8 G1/4												

Table 1. Mandatory frequencies and signal bandwidths to support.

Signal bandwidth	8 MHz														
Center frequency [MHz]	114.0	114.5	170.0	170.5	177.5	178.0	226.0	226.5	233.5	234.0	296.5	298.0	306.0	386.0	466.0
DVB-T mode / Channel Id	D1	S2	D8	S10	K5	D9	D15	K12	S11	D16	S20	D24	S21	S31	S41
8k 64QAM R2/3 G1/8															
8k 64QAM R3/4 G1/4															

Table 2. Optional frequencies and signal bandwidths to support.

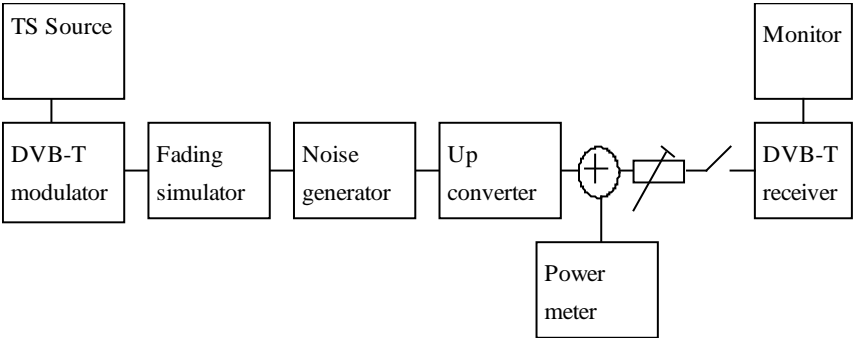

<b>Test Case</b>	<b>Task 3:20 Performance: C/N performance on 0dB echo channel</b>
<b>Section</b>	NorDig Unified 3.4.10.3
<b>Requirement</b>	The NorDig IRD shall have a QEF performance for the C/N ratios given in Table 3.9, or better performance.
<b>IRD profile(s)</b>	Basic, IRD, DVB-T
<b>Test procedure</b>	<p><b>Purpose of test:</b> To test the required C/N for quasi error free reception in 0 dB echo channel.</p> <p><b>Equipment:</b></p>  <p>The 0 degree channel center shall be used in fading simulator (see 2.3.5 0dB echo).</p> <p><b>Test procedure for 0 dB echo channel:</b></p> <p>Check the different SFN synchronization issues from 2.3.4 Receiver operability in SFN.</p> <ol style="list-style-type: none"> <li>1. Set up the test instruments</li> <li>2. Use the following mode {8K, 64QAM, R=2/3, <math>\Delta/T_U=1/8</math>} and signal bandwidth 8MHz.</li> <li>3. Set the up-converter to frequency 666MHz (K45)</li> <li>4. Set the fading simulator to 0dB echo profile. (Delay 1.95us, 0 degree phase at channel center and attenuation 0dB for the second path.)</li> <li>5. Measure the input level to the attenuator.</li> <li>6. Determine the attenuation of the attenuator and the cables.</li> <li>7. Calculate the receiver input signal level and set it to -50dBm.</li> <li>8. Increase the C/N from low value to higher value until the quality measurement procedure 2 (QMP2) is fulfilled.</li> <li>9. Fill in the measured value in dB in the measurement record.</li> <li>10. Verify also that the channel search finds the services at the measured C/N.</li> <li>11. Repeat the test for the mode {8K, 64QAM, R=3/4, <math>\Delta/T_U=1/4</math>} and signal bandwidth 8MHz.</li> <li>12. Repeat the test for rest of the DVB-T modes combinations with 8MHz signal bandwidth in measurement record.</li> <li>13. Set the up-converter to frequency 198.5MHz (K8).</li> <li>14. Use the following mode {8K, 64QAM, R=2/3, <math>\Delta/T_U=1/8</math>} and signal bandwidth 7MHz.</li> <li>15. Repeat the test for rest of the DVB-T mode combinations with 7MHz signal bandwidth in measurement record.</li> </ol> <p>(Measurement can be done by changing the modulation/code rate first and after that echo delay depending of the measurement equipment).</p>

	<p><b>Expected result:</b> The required C/N for quasi error free reception in 0 dB echo channel is less than specified in table 3.9</p>																																																
<b>Test result(s)</b>	<p>Measurement record:</p> <table border="1" data-bbox="635 405 1091 819"> <thead> <tr> <th colspan="2">8MHz signal bandwidth at f=666MHz</th> </tr> <tr> <th>DVB-T mode</th> <th>Required C/N (0dB 1.95µs)</th> </tr> </thead> <tbody> <tr><td>8k QPSK R1/2 G1/4</td><td></td></tr> <tr><td>8k QPSK R2/3 G1/4</td><td></td></tr> <tr><td>8k QPSK R3/4 G1/4</td><td></td></tr> <tr><td>8k 16QAM R1/2 G1/4</td><td></td></tr> <tr><td>8k 16QAM R2/3 G1/4</td><td></td></tr> <tr><td>8k 16QAM R3/4 G1/4</td><td></td></tr> <tr><td>8k 64QAM R1/2 G1/4</td><td></td></tr> <tr><td>8k 64QAM R2/3 G1/8</td><td></td></tr> <tr><td>8k 64QAM R2/3 G1/4</td><td></td></tr> <tr><td>8k 64QAM R3/4 G1/4</td><td></td></tr> </tbody> </table> <p>Table 1. Required C/N for 0dB 1.95µs echo in signal bandwidth 8MHz.</p> <table border="1" data-bbox="635 880 1091 1294"> <thead> <tr> <th colspan="2">7MHz signal bandwidth at f=198.5MHz</th> </tr> <tr> <th>DVB-T mode</th> <th>Required C/N (0dB 1.95µs)</th> </tr> </thead> <tbody> <tr><td>8k QPSK R1/2 G1/4</td><td></td></tr> <tr><td>8k QPSK R2/3 G1/4</td><td></td></tr> <tr><td>8k QPSK R3/4 G1/4</td><td></td></tr> <tr><td>8k 16QAM R1/2 G1/4</td><td></td></tr> <tr><td>8k 16QAM R2/3 G1/4</td><td></td></tr> <tr><td>8k 16QAM R3/4 G1/4</td><td></td></tr> <tr><td>8k 64QAM R1/2 G1/4</td><td></td></tr> <tr><td>8k 64QAM R2/3 G1/8</td><td></td></tr> <tr><td>8k 64QAM R2/3 G1/4</td><td></td></tr> <tr><td>8k 64QAM R3/4 G1/4</td><td></td></tr> </tbody> </table> <p>Table 2. Required C/N for 0dB 1.95µs echo in signal bandwidth 7MHz.</p>	8MHz signal bandwidth at f=666MHz		DVB-T mode	Required C/N (0dB 1.95µs)	8k QPSK R1/2 G1/4		8k QPSK R2/3 G1/4		8k QPSK R3/4 G1/4		8k 16QAM R1/2 G1/4		8k 16QAM R2/3 G1/4		8k 16QAM R3/4 G1/4		8k 64QAM R1/2 G1/4		8k 64QAM R2/3 G1/8		8k 64QAM R2/3 G1/4		8k 64QAM R3/4 G1/4		7MHz signal bandwidth at f=198.5MHz		DVB-T mode	Required C/N (0dB 1.95µs)	8k QPSK R1/2 G1/4		8k QPSK R2/3 G1/4		8k QPSK R3/4 G1/4		8k 16QAM R1/2 G1/4		8k 16QAM R2/3 G1/4		8k 16QAM R3/4 G1/4		8k 64QAM R1/2 G1/4		8k 64QAM R2/3 G1/8		8k 64QAM R2/3 G1/4		8k 64QAM R3/4 G1/4	
8MHz signal bandwidth at f=666MHz																																																	
DVB-T mode	Required C/N (0dB 1.95µs)																																																
8k QPSK R1/2 G1/4																																																	
8k QPSK R2/3 G1/4																																																	
8k QPSK R3/4 G1/4																																																	
8k 16QAM R1/2 G1/4																																																	
8k 16QAM R2/3 G1/4																																																	
8k 16QAM R3/4 G1/4																																																	
8k 64QAM R1/2 G1/4																																																	
8k 64QAM R2/3 G1/8																																																	
8k 64QAM R2/3 G1/4																																																	
8k 64QAM R3/4 G1/4																																																	
7MHz signal bandwidth at f=198.5MHz																																																	
DVB-T mode	Required C/N (0dB 1.95µs)																																																
8k QPSK R1/2 G1/4																																																	
8k QPSK R2/3 G1/4																																																	
8k QPSK R3/4 G1/4																																																	
8k 16QAM R1/2 G1/4																																																	
8k 16QAM R2/3 G1/4																																																	
8k 16QAM R3/4 G1/4																																																	
8k 64QAM R1/2 G1/4																																																	
8k 64QAM R2/3 G1/8																																																	
8k 64QAM R2/3 G1/4																																																	
8k 64QAM R3/4 G1/4																																																	
<b>Conformity</b>	<input type="checkbox"/> <b>OK Fault</b> <input type="checkbox"/> Major <input type="checkbox"/> Minor, define fail reason in comments																																																
<b>Comments</b>	<p>If possible describe if fault can be fixed with software update: <input type="checkbox"/> <b>YES</b> <input type="checkbox"/> <b>NO</b> Describe more specific faults and/or other information</p>																																																
<b>Date</b>	<table border="1" style="width: 100%;"> <tr> <td style="width: 50%;"></td> <td style="width: 50%; text-align: center;"><i>Sign</i></td> </tr> </table>		<i>Sign</i>																																														
	<i>Sign</i>																																																

<b>Test Case</b>	<b>Task 3:21 Performance: Minimum receiver signal input levels on Gaussian channel</b>
<b>Section</b>	NorDig Unified 3.4.10.4
<b>Requirement</b>	The NorDig IRD shall have at least the performance for the signal input levels for the supported frequency range and should have a performance which is one dB better than specified in Table 3.13
<b>IRD profile(s)</b>	Basic, IRD, DVB-T
<b>Test procedure</b>	<b>Purpose of test:</b> To verify the sensitivity of the receiver on Gaussian channel over the supported frequency range.

**Equipment:**

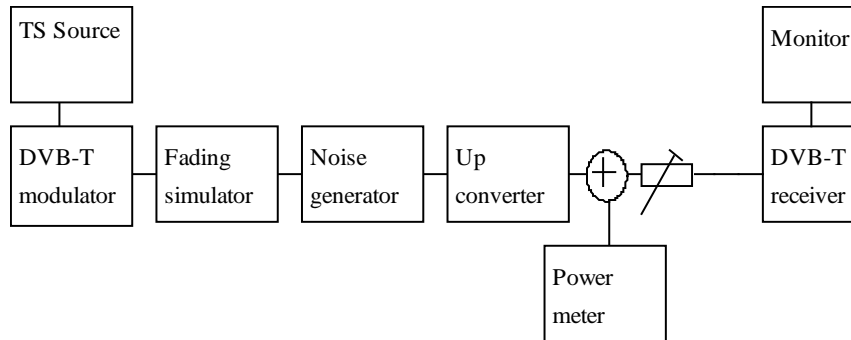

Be careful in impedance matching of cables, adapters and etc.

**Test procedure for the sensitivity on the gaussian channel:**

1. Set up the test instruments
2. Use the following DVB-T mode {8K, 64QAM, R=2/3,  $\Delta/T_U=1/8$ } and signal bandwidth 8MHz.
3. Set the up-converter to frequency 474MHz (K21).
4. Measure the input level to the attenuator.
5. Determine the attenuation of the attenuator and the cables.
6. Calculate the receiver input signal.
7. Do the channel search.
8. Increase the received input level from low value to higher value until the quality measurement procedure 2 (QMP2) is fulfilled.
9. Fill in the measured value in the measurement record.
10. Repeat the test for the rest of the frequencies, DVB-T modes and signal bandwidths on measurement record.

**Expected result:**

Sensitivity shall be equal or better for all measured frequencies (channels) and for all DVB-T modes and signal bandwidths as specified in Table 3.13.

<b>Test result(s)</b>	Measurement record: See following page.	
<b>Conformity</b>	<input type="checkbox"/> OK Fault <input type="checkbox"/> Major <input type="checkbox"/> Minor, define fail reason in comments	
<b>Comments</b>	If possible describe if fault can be fixed with software update: <input type="checkbox"/> YES <input type="checkbox"/> NO Describe more specific faults and/or other information	
<b>Date</b>		<b>Sign</b>

Measurement records:

Signal bandwidth	7 MHz			8 MHz								
Center frequency [MHz]	177.5	198.5	226.5	474.0	522.0	570.0	618.0	666.0	714.0	762.0	810.0	858.0
DVB-T mode / Channel Id	K5	K8	K12	K21	K27	K33	K39	K45	K51	K57	K63	K69
8k QPSK R1/2 G1/4												
8k QPSK R2/3 G1/4												
8k QPSK R3/4 G1/4												
8k QPSK R5/6 G1/4												
8k QPSK R7/8 G1/4												
8k 16QAM R1/2 G1/4												
8k 16QAM R2/3 G1/4												
8k 16QAM R3/4 G1/4												
8k 16QAM R5/6 G1/4												
8k 16QAM R7/8 G1/4												
8k 64QAM R1/2 G1/4												
8k 64QAM R2/3 G1/4												
8k 64QAM R2/3 G1/8												
8k 64QAM R3/4 G1/4												
8k 64QAM R5/6 G1/4												
8k 64QAM R7/8 G1/4												

Table 1. Mandatory frequencies and signal bandwidths to support.

Signal bandwidth	8 MHz														
Center frequency [MHz]	114.0	114.5	170.0	170.5	177.5	178.0	226.0	226.5	233.5	234.0	296.5	298.0	306.0	386.0	466.0
DVB-T mode / Channel Id	D1	S2	D8	S10	K5	D9	D15	K12	S11	D16	S20	D24	S21	S31	S41
8k 64QAM R2/3 G1/8															
8k 64QAM R3/4 G1/4															

Table 2. Optional frequencies and signal bandwidths to support.

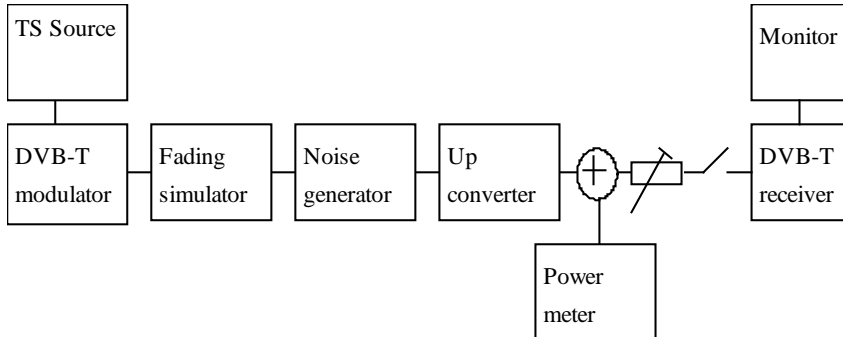
<b>Test Case</b>	<b>Task 3:22 Performance: Minimum IRD Signal Input Levels on 0dB echo channel</b>
<b>Section</b>	NorDig Unified 3.4.10.4
<b>Requirement</b>	The NorDig IRD shall have at least the performance for the signal input level for the supported frequency range and should have a performance which is 1dB better than specified in Table 3.13.
<b>IRD profile(s)</b>	Basic, IRD, DVB-T
<b>Test procedure</b>	<p><b>Purpose of test:</b> To verify the sensitivity of the receiver on frequency selective channel.</p> <p><b>Equipment:</b></p> 





	8k 64QAM R1/2 G1/4											
	8k 64QAM R2/3 G1/4											
	8k 64QAM R2/3 G1/8											
	8k 64QAM R3/4 G1/4											
<b>Conformity</b>	<input type="checkbox"/> OK Fault <input type="checkbox"/> Major <input type="checkbox"/> Minor, define fail reason in comments											
<b>Comments</b>	If possible describe if fault can be fixed with software update: <input type="checkbox"/> YES <input type="checkbox"/> NO Describe more specific faults and/or other information											
<b>Date</b>							<b>Sign</b>					

<b>Test Case</b>	<b>Task 3:23 Performance: Noise figure on Gaussian channel</b>
<b>Section</b>	NorDig Unified 3.4.10.4
<b>Requirement</b>	The NorDig IRD shall have a noise figure (NF) for supported frequency ranges equal or better than the values specified in Table 3.12.
<b>IRD profile(s)</b>	Basic, IRD, DVB-T
<b>Test procedure</b>	<p><b>Purpose of test:</b> To calculate the noise figure of the receiver for gaussian channel.</p> <p><b>Equipment:</b> No equipment needed.</p> <p><b>Test procedure for evaluation of the noise figure:</b></p> <p>Determine the minimum carrier levels <math>C_{min}</math> for the gaussian channel measured in last test Task 3:21 (Performance - Minimum IRD Signal Input Levels on Gaussian channel).</p> <p>Determine the required <math>C/N_{min}</math> for the gaussian channel measured in last test Task 3:19 (Performance - C/N performance on Gaussian channel).</p> <p>Calculate the noise figure NF[dB] for the supported frequencies using the formulas</p> <p>For 8MHz DVB-T signal: <math>NF[dB] = N + 105.2dBm = C_{min} - C/N_{min} + 105.2dBm</math>  For 7MHz DVB-T signal: <math>NF[dB] = N + 105.7dBm = C_{min} - C/N_{min} + 105.7dBm</math></p> <p><b>Expected result:</b> The noise figure is less than or equal to table 3.11.</p>

<b>Test result(s)</b>	<p>Measurement record:</p> <table border="1" style="width: 100%; border-collapse: collapse;"> <tr><td>Frequency</td><td>177.5</td><td>198.5</td><td>226.5</td></tr> <tr><td>Channel id</td><td>K5</td><td>K8</td><td>K12</td></tr> <tr><td>Signal bandwidth</td><td colspan="3">7MHz</td></tr> <tr><td>Mode</td><td colspan="3">NF [dB]</td></tr> <tr><td>8k 64QAM R2/3</td><td></td><td></td><td></td></tr> <tr><td>8k 64QAM R3/4</td><td></td><td></td><td></td></tr> </table> <table border="1" style="width: 100%; border-collapse: collapse;"> <tr><td>Frequency</td><td>474.0</td><td>522.0</td><td>570.0</td><td>618.0</td><td>666.0</td><td>714.0</td><td>762.0</td><td>810.0</td><td>858.0</td></tr> <tr><td>Channel id</td><td>K21</td><td>K27</td><td>K33</td><td>K39</td><td>K45</td><td>K51</td><td>K57</td><td>K63</td><td>K69</td></tr> <tr><td>Signal bandwidth</td><td colspan="9">8MHz</td></tr> <tr><td>Mode</td><td colspan="9">NF [dB]</td></tr> <tr><td>8k 64QAM R2/3</td><td></td><td></td><td></td><td></td><td></td><td></td><td></td><td></td><td></td></tr> <tr><td>8k 64QAM R3/4</td><td></td><td></td><td></td><td></td><td></td><td></td><td></td><td></td><td></td></tr> </table> <p>Table 1. Mandatory frequencies and signal bandwidths to support.</p> <table border="1" style="width: 100%; border-collapse: collapse;"> <tr><td>Frequency</td><td>114.0</td><td>114.5</td><td>170.0</td><td>170.5</td><td>177.5</td><td>178.0</td><td>226.0</td><td>226.5</td></tr> <tr><td>Channel id</td><td>D1</td><td>S2</td><td>D8</td><td>S10</td><td>K5</td><td>D9</td><td>D15</td><td>K12</td></tr> <tr><td>Signal bandwidth</td><td colspan="8">8MHz</td></tr> <tr><td>Mode</td><td colspan="8">NF [dB]</td></tr> <tr><td>8k 64QAM R2/3</td><td></td><td></td><td></td><td></td><td></td><td></td><td></td><td></td></tr> <tr><td>8k 64QAM R3/4</td><td></td><td></td><td></td><td></td><td></td><td></td><td></td><td></td></tr> </table> <table border="1" style="width: 100%; border-collapse: collapse;"> <tr><td>Frequency</td><td>233.5</td><td>234.0</td><td>296.5</td><td>298.0</td><td>306.0</td><td>386.0</td><td>466.0</td></tr> <tr><td>Channel id</td><td>S11</td><td>D16</td><td>S20</td><td>D24</td><td>S21</td><td>S31</td><td>S41</td></tr> <tr><td>Signal bandwidth</td><td colspan="7">8MHz</td></tr> <tr><td>Mode</td><td colspan="7">NF [dB]</td></tr> <tr><td>8k 64QAM R2/3</td><td></td><td></td><td></td><td></td><td></td><td></td><td></td></tr> <tr><td>8k 64QAM R3/4</td><td></td><td></td><td></td><td></td><td></td><td></td><td></td></tr> </table> <p>Table 2. Optional frequencies and signal bandwidths to support.</p>	Frequency	177.5	198.5	226.5	Channel id	K5	K8	K12	Signal bandwidth	7MHz			Mode	NF [dB]			8k 64QAM R2/3				8k 64QAM R3/4				Frequency	474.0	522.0	570.0	618.0	666.0	714.0	762.0	810.0	858.0	Channel id	K21	K27	K33	K39	K45	K51	K57	K63	K69	Signal bandwidth	8MHz									Mode	NF [dB]									8k 64QAM R2/3										8k 64QAM R3/4										Frequency	114.0	114.5	170.0	170.5	177.5	178.0	226.0	226.5	Channel id	D1	S2	D8	S10	K5	D9	D15	K12	Signal bandwidth	8MHz								Mode	NF [dB]								8k 64QAM R2/3									8k 64QAM R3/4									Frequency	233.5	234.0	296.5	298.0	306.0	386.0	466.0	Channel id	S11	D16	S20	D24	S21	S31	S41	Signal bandwidth	8MHz							Mode	NF [dB]							8k 64QAM R2/3								8k 64QAM R3/4							
Frequency	177.5	198.5	226.5																																																																																																																																																																																								
Channel id	K5	K8	K12																																																																																																																																																																																								
Signal bandwidth	7MHz																																																																																																																																																																																										
Mode	NF [dB]																																																																																																																																																																																										
8k 64QAM R2/3																																																																																																																																																																																											
8k 64QAM R3/4																																																																																																																																																																																											
Frequency	474.0	522.0	570.0	618.0	666.0	714.0	762.0	810.0	858.0																																																																																																																																																																																		
Channel id	K21	K27	K33	K39	K45	K51	K57	K63	K69																																																																																																																																																																																		
Signal bandwidth	8MHz																																																																																																																																																																																										
Mode	NF [dB]																																																																																																																																																																																										
8k 64QAM R2/3																																																																																																																																																																																											
8k 64QAM R3/4																																																																																																																																																																																											
Frequency	114.0	114.5	170.0	170.5	177.5	178.0	226.0	226.5																																																																																																																																																																																			
Channel id	D1	S2	D8	S10	K5	D9	D15	K12																																																																																																																																																																																			
Signal bandwidth	8MHz																																																																																																																																																																																										
Mode	NF [dB]																																																																																																																																																																																										
8k 64QAM R2/3																																																																																																																																																																																											
8k 64QAM R3/4																																																																																																																																																																																											
Frequency	233.5	234.0	296.5	298.0	306.0	386.0	466.0																																																																																																																																																																																				
Channel id	S11	D16	S20	D24	S21	S31	S41																																																																																																																																																																																				
Signal bandwidth	8MHz																																																																																																																																																																																										
Mode	NF [dB]																																																																																																																																																																																										
8k 64QAM R2/3																																																																																																																																																																																											
8k 64QAM R3/4																																																																																																																																																																																											
<b>Conformity</b>	<input type="checkbox"/> <b>OK Fault</b> <input type="checkbox"/> Major <input type="checkbox"/> Minor, define fail reason in comments																																																																																																																																																																																										
<b>Comments</b>	If possible describe if fault can be fixed with software update: <input type="checkbox"/> <b>YES</b> <input type="checkbox"/> <b>NO</b> Describe more specific faults and/or other information																																																																																																																																																																																										
<b>Date</b>	<table border="1" style="width: 100%; border-collapse: collapse;"> <tr> <td style="width: 50%;"></td> <td style="width: 50%; text-align: center;"><i>Sign</i></td> </tr> </table>		<i>Sign</i>																																																																																																																																																																																								
	<i>Sign</i>																																																																																																																																																																																										

<b>Test Case</b>	<b>Task 3:24 Performance: Maximum Receiver Signal Input Levels</b>
<b>Section</b>	NorDig Unified 3.4.10.5 and 3.4.10.6
<b>Requirement</b>	The receiver shall provide QEF reception for DVB-T signals up to a level of -35dBm.

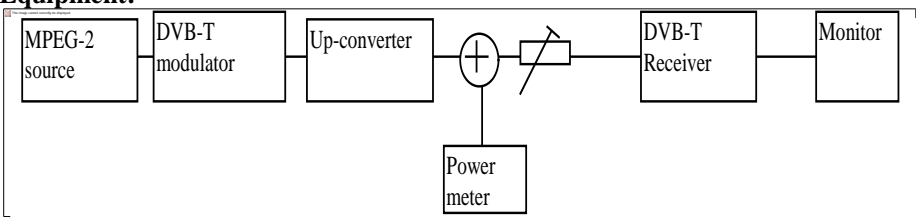

	<p>The maximum analogue TV signal level is restricted to <math>-20</math> dBm defined as the r.m.s (root mean square) value of the vision carrier at peaks of the modulated envelope.</p> <p>The DVB-T signal level is valid for the modes {8K, 64-QAM, <math>R=2/3</math>, <math>\Delta/T_u=1/8</math>}, {8K, 64-QAM, <math>R=2/3</math>, <math>\Delta/T_u=1/4</math>} and {8K, 64-QAM, <math>R=3/4</math>, <math>\Delta/T_u=1/4</math>}.</p>												
<p><b>IRD profile(s)</b></p>	<p>Basic, IRD, DVB-T</p>												
<p><b>Test procedure</b></p>	<p><b>Purpose of test:</b></p> <p>To test that the receiver is able to handle RF signals with high value.</p> <p><b>Equipment:</b></p>  <p><b>Test procedure</b></p> <ol style="list-style-type: none"> <li>1. Set up the test instruments.</li> <li>2. Determine the attenuation of the attenuator.</li> <li>3. Use the following mode {8K, 64-QAM, <math>R=2/3</math>, <math>\Delta/T_u=1/8</math>}.</li> <li>4. Set the up-converter to channel 45.</li> <li>5. Determine the attenuation of the attenuator and the cables.</li> <li>6. Turn on the receiver.</li> <li>7. Check that the picture is decoded correctly.</li> <li>8. Calculate the receiver input signal level as a function of attenuation in attenuator.</li> <li>9. Increase the receiver input signal level. until the quality measurement procedure 1 (QMP1) is fulfilled.</li> <li>10. Fill in the result in the measurement record.</li> <li>11. Repeat the test for the modes {8K, 64-QAM, <math>R=2/3</math>, <math>\Delta/T_u=1/4</math>} and {8K, 64-QAM, <math>R=3/4</math>, <math>\Delta/T_u=1/4</math>}.</li> </ol> <p><b>Expected result:</b></p> <p>The reception shall be QEF for input level higher than or equal to <math>-35</math>dBm for defined DVB-T modes.</p>												
<p><b>Test result(s)</b></p>	<p>Measurement record:</p> <table border="1" data-bbox="391 1883 1270 2018"> <thead> <tr> <th>Mode</th> <th>Requirement dBm</th> <th>Result</th> </tr> </thead> <tbody> <tr> <td>8K, 64-QAM, <math>R=2/3</math>, <math>\Delta/T_u=1/8</math></td> <td>-35</td> <td></td> </tr> <tr> <td>8K, 64-QAM, <math>R=2/3</math>, <math>\Delta/T_u=1/4</math></td> <td>-35</td> <td></td> </tr> <tr> <td>8K, 64-QAM, <math>R=3/4</math>, <math>\Delta/T_u=1/4</math></td> <td>-35</td> <td></td> </tr> </tbody> </table>	Mode	Requirement dBm	Result	8K, 64-QAM, $R=2/3$ , $\Delta/T_u=1/8$	-35		8K, 64-QAM, $R=2/3$ , $\Delta/T_u=1/4$	-35		8K, 64-QAM, $R=3/4$ , $\Delta/T_u=1/4$	-35	
Mode	Requirement dBm	Result											
8K, 64-QAM, $R=2/3$ , $\Delta/T_u=1/8$	-35												
8K, 64-QAM, $R=2/3$ , $\Delta/T_u=1/4$	-35												
8K, 64-QAM, $R=3/4$ , $\Delta/T_u=1/4$	-35												

<b>Conformity</b>	<input type="checkbox"/> OK Fault <input type="checkbox"/> Major <input type="checkbox"/> Minor, define fail reason in comments	
<b>Comments</b>	If possible describe if fault can be fixed with software update: <input type="checkbox"/> YES <input type="checkbox"/> NO Describe more specific faults and/or other information	
<b>Date</b>		<b>Sign</b>

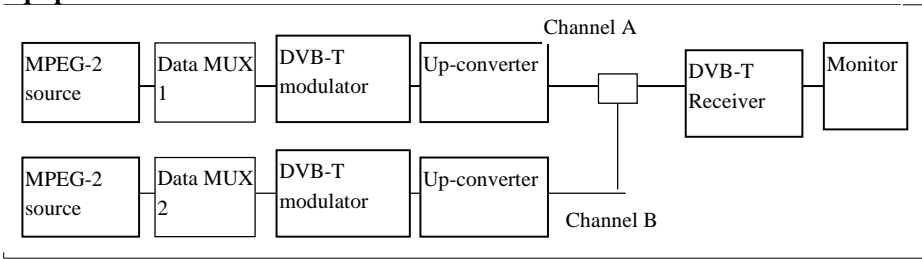
<b>Test Case</b>	<b>Task 3:25 Performance: Immunity to “digital” signals in Other Channels</b>
<b>Section</b>	NorDig Unified 3.4.10.7.1
<b>Requirement</b>	<p>The NorDig IRD shall, for the supported frequency ranges, permit an interfering DVB-T signal with a minimum interference to signal level ratio (I/C) as stated in table 3.16 while maintaining QEF reception.</p> <p>The requirements in this paragraph refer to the modes {8K, 64-QAM, R=2/3, Δ/Tu =1/8} and {8K, 64-QAM, R=2/3, Δ/Tu =1/4} and {8K, 64-QAM, R=3/4, Δ/Tu =1/4}</p>
<b>IRD profile(s)</b>	Basic, IRD, DVB-T
<b>Test procedure</b>	<p><b>Purpose of test:</b> To verify the QEF reception when there is interference from DVB-T signal on adjacent or other channels.</p> <p><b>Equipment:</b></p>  <p>Verify that the digital TV signal on the adjacent or the other channels don't have too high shoulders, which could cause out-of-band emissions in the reception of the wanted digital TV signal.</p> <p><b>Test procedure:</b></p> <ol style="list-style-type: none"> <li>1. Set up the test instruments</li> <li>2. Use the following DVB-T mode {8K, 64-QAM, R=2/3, Δ/T<sub>U</sub>=1/8} and signal bandwidth 8MHz.</li> <li>3. Set the channel A up-converter to 666.0MHz (K45).</li> <li>4. Set the channel B up-converter to 674.0MHz (K46).</li> <li>5. Set the receiver input level for the DVB-T signal in channel B to -30 dBm.</li> <li>6. Decrease the DVB-T signal level in channel A to a signal level when the quality measurement procedure 2 (QMP2) is still fulfilled.</li> <li>7. Fill in the measured signal level difference between channel A and channel B signals in dB in measurement record.</li> <li>8. Repeat the test when the channel B up-converter is set to frequencies 658.0 MHz (K44), 650.0 MHz (K43), 682.0 MHz (K47).</li> <li>9. Repeat the test according to procedure above for the image channel<sup>1)</sup>. Set the receiver input level for the DVB-T signal in channel B to -30dBm.</li> <li>10. Repeat the test for the DVB-T modes {8K, 64-QAM, R=2/3, Δ/T<sub>U</sub>=1/4} and</li> </ol>

- {8K, 64-QAM, R=3/4,  $\Delta/T_U=1/4$ } using signal bandwidth 8MHz,
11. Change the signal bandwidth to 7MHz.
  12. Set the channel A up-converter to frequency 198.5 MHz (K8).
  13. Set the channel B up-converter to frequency 205.5 MHz (K9).
  14. Set the receiver input level of the DVB-T signal in channel B to -30dBm.
  15. Decrease the DVB-T signal level in channel A to a signal level when the quality measurement procedure 2 is fulfilled.
  16. Fill in the measured signal level difference between channel A and channel B signals in dB in measurement record.
  17. Repeat the test when the channel B up-converter is set to frequencies 191.5 MHz (K7), 184.5 MHz (K6) and 212.5 MHz (K10).
  18. Repeat the test for the DVB-T modes {8K, 64-QAM, R=2/3,  $\Delta/T_U=1/4$ } and {8K, 64-QAM, R=3/4,  $\Delta/T_U=1/4$ } using signal bandwidth 7MHz,

<sup>1)</sup> Example: if intermediate frequency IF is 36.15MHz, the image channel is calculated for channel 45 as  $666\text{MHz} + 2 * 36.15\text{MHz} = 738.3\text{MHz}$  which is close to channel 54.

**Expected result:**

The protection ratios shall be fulfilled for received signal at the requested quality level for specified DVB-T modes, signal bandwidths and supported frequencies.

**Test result(s)**

Measurement record:

	7 MHz signal bandwidth			
Interferer center frequency [MHz]	184.5	191.5	205.5	212.5
DVB-T mode / Channel id	K6	K7	K9	K10
8K, 64-QAM, R=2/3, $\Delta/T_U=1/8$				
8K, 64-QAM, R=2/3, $\Delta/T_U=1/4$				
8K, 64-QAM, R=3/4, $\Delta/T_U=1/4$				

Table 1. Mandatory VHF Band III frequencies and signal bandwidth to support

	8 MHz signal bandwidth				
Interferer center frequency [MHz]	650.0	658.0	674.0	682.0	738.0
DVB-T mode / Channel id	K43	K44	K46	K47	K54
8K, 64-QAM, R=2/3, $\Delta/T_U=1/8$					
8K, 64-QAM, R=2/3, $\Delta/T_U=1/4$					
8K, 64-QAM, R=3/4, $\Delta/T_U=1/4$					

Table 2. Mandatory UHF Band IV/V frequencies and signal bandwidth to support

	7 MHz signal bandwidth			
Center frequency [MHz]	128.5	135.5	149.5	156.5
DVB-T mode / Channel id	S4	S5	S7	S8
8K, 64-QAM, R=2/3, $\Delta/T_U=1/8$				
8K, 64-QAM, R=2/3, $\Delta/T_U=1/4$				
8K, 64-QAM, R=3/4, $\Delta/T_U=1/4$				

Table 3. Optional VHF S Band I frequencies and signal bandwidth to support

	8 MHz signal bandwidth			
Center frequency [MHz]	122.0	130.0	146.0	154.0
DVB-T mode / Channel id	D2	D3	D5	D6
8K, 64-QAM, R=2/3, $\Delta/T_U=1/8$				
8K, 64-QAM, R=2/3, $\Delta/T_U=1/4$				

8K, 64-QAM, R=3/4, $\Delta/T_U = 1/4$				
---------------------------------------	--	--	--	--

Table 4. Optional VHF S Band I frequencies and signal bandwidth to support

	8 MHz signal bandwidth			
Center frequency [MHz]	186.0	194.0	210.0	218.0
DVB-T mode / Channel id	D10	D11	D13	D14
8K, 64-QAM, R=2/3, $\Delta/T_U = 1/8$				
8K, 64-QAM, R=2/3, $\Delta/T_U = 1/4$				
8K, 64-QAM, R=3/4, $\Delta/T_U = 1/4$				

Table 5. Optional VHF Band III frequencies and signal bandwidth to support

	7 MHz signal bandwidth			
Center frequency [MHz]	247.5	254.5	268.5	275.5
DVB-T mode / Channel id	S13	S14	S16	S17
8K, 64-QAM, R=2/3, $\Delta/T_U = 1/8$				
8K, 64-QAM, R=2/3, $\Delta/T_U = 1/4$				
8K, 64-QAM, R=3/4, $\Delta/T_U = 1/4$				

Table 6. Optional VHF S Band II frequencies and signal bandwidth to support

	8 MHz signal bandwidth			
Center frequency [MHz]	250.0	258.0	274.0	282.0
DVB-T mode / Channel id	D18	D19	D21	D22
8K, 64-QAM, R=2/3, $\Delta/T_U = 1/8$				
8K, 64-QAM, R=2/3, $\Delta/T_U = 1/4$				
8K, 64-QAM, R=3/4, $\Delta/T_U = 1/4$				

Table 7. Optional VHF S Band II frequencies and signal bandwidth to support

	8 MHz signal bandwidth			
Center frequency [MHz]	370.0	378.0	394.0	402.0
DVB-T mode / Channel id	S29	S30	S32	S33
8K, 64-QAM, R=2/3, $\Delta/T_U = 1/8$				
8K, 64-QAM, R=2/3, $\Delta/T_U = 1/4$				
8K, 64-QAM, R=3/4, $\Delta/T_U = 1/4$				

Table 8. Optional UHF S Band III frequencies and signal bandwidth to support

<b>Conformity</b>	<input type="checkbox"/> OK <input type="checkbox"/> Fault <input type="checkbox"/> Major <input type="checkbox"/> Minor, define fail reason in comments	
<b>Comments</b>	If possible describe if fault can be fixed with software update: <input type="checkbox"/> YES <input type="checkbox"/> NO Describe more specific faults and/or other information	
<b>Date</b>		<b>Sign</b>

<b>Test Case</b>	<b>Task 3:26 Performance: Immunity to “LTE 700 MHz” signals in Other Channels</b>
<b>Section</b>	NorDig Unified 3.4.10.7.2
<b>Requirement</b>	The terrestrial NorDig IRD and IRD-T2 shall, for the supported frequency ranges, permit an interfering 4G (LTE) “700MHz” signal with a minimum interference to signal level ratio (I/C) as stated in the Table 3.xx (1) while maintaining QEF reception.  The power of the interfering LTE signal, both BS and UE, varies with a traffic load and traffic type. The signal power of the LTE signal is defined as the power during the active part of the time varying LTE signal, referred to as the licensed power level (I).

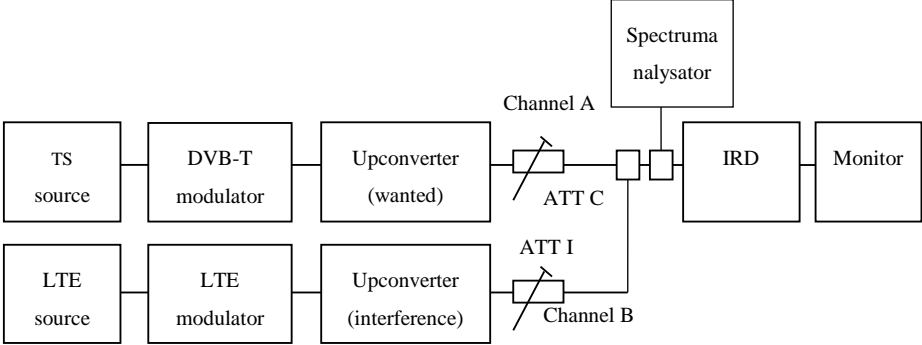
	<p>The I/C values shall (1) be fulfilled for LTE signals with traffic loads from 0% to 100 % (BS) and for traffic loads from low bit rate to high bit rate (UE). Low traffic loads can be the most demanding ones. The minimum I/C requirement shall be fulfilled for -25 dBm in case of UE signals and -15dBm in case of BS signals defined as licensed power of interfering signal, at the input of the IRD.</p> <p>The requirements in this paragraph refer, for DVB-T, to following modes {FFT size, modulation, code rate, guard interval, bandwidth}; {8K, 64-QAM, R=2/3, <math>\Delta/T_u = 1/8</math>, 8MHz} and {8K, 64-QAM, R=2/3, <math>\Delta/T_u = 1/4</math>, 8MHz} and {8K, 64-QAM, R=3/4, <math>\Delta/T_u = 1/4</math>, 8MHz} and and for DVB-T2 to the modes {FFT size, modulation, pilot pattern, code rate, guard interval, bandwidth} {32KE, 256-QAM R, PP4, R=2/3, <math>\Delta/T_u = 1/16</math>, 8MHz} {32KE, 256-QAM R, PP4, R=3/5, <math>\Delta/T_u = 19/256</math>, 8MHz} {32KN, 256-QAM R, PP4, R=2/3, <math>\Delta/T_u = 19/256</math>, 7MHz} and</p>
<p><b>IRD Profile(s)</b></p>	<p>Basic, IRD, DVB-T</p>
<p><b>Test procedure</b></p>	<p><b>Purpose of test:</b> To verify the QEF reception for LTE 700 MHz signal interference on adjacent or other channels.</p> <p><b>Equipment:</b></p>  <p>Verify that the interfering LTE signal on the adjacent or the other channels don't have too high shoulders, which could cause out-of-band emissions in the reception of the wanted digital TV signal.</p> <p>From IRD point of view most demanding LTE signal might be that with low traffic load.</p> <p>The LTE transmission is generated by using following LTE signal characteristics: BS 0% traffic load (LTE_BS-idle_V3_synth.wv) UE Video stream traffic (short_UE-Video-Stream_V2.wv)</p> <p>Files in I/Q file format specified above are available on NorDig homepage.</p> <p><b>Test procedure:</b></p> <ol style="list-style-type: none"> <li>1. Set up the test instruments</li> <li>2. Use the following DVB-T mode {8K, 64-QAM, R=2/3, <math>\Delta/T_u = 1/8</math>, 8MHz }</li> <li>3. Set the channel A up-converter to 690.0MHz (K48).</li> <li>4. Set the channel B up-converter to 708.0MHz .</li> <li>5. Set the LTE interfere to UE Video traffic mode.</li> <li>6. Set the receiver input level for the LTE signal in channel B to -25 dBm.</li> </ol>

	<ol style="list-style-type: none"> <li>7. Decrease the wanted signal level in channel A to a signal level when the quality measurement procedure 2 is still fulfilled.</li> <li>8. Fill in the measured signal level difference between channel A and channel B signals in dB in measurement record.</li> <li>9. Repeat the test when the channel B up-converter is set to frequencies 718.0 MHz, 728.0 MHz.</li> <li>10. Set the channel B up-converter to 763.0MHz.</li> <li>11. Set the LTE interfere to BS 0% traffic load mode.</li> <li>12. Set the receiver input level for the LTE signal in channel B to -15 dBm.</li> <li>13. Decrease the wanted signal level in channel A to a signal level when the quality measurement procedure 2 is still fulfilled.</li> <li>14. Fill in the measured signal level difference between channel A and channel B signals in dB in measurement record.</li> <li>15. Repeat the test when the channel B up-converter is set to frequencies 773.0 MHz, 783.0 MHz.</li> <li>16. Repeat the test for the DVB-T mode {8K,64-QAM,R=3/4,<math>\Delta/Tu = 1/4</math>,8MHz}.</li> </ol> <p><b>Expected result:</b></p> <p>The wanted DVB-T signal shall be QEF for the interference signal levels as specified.</p>																														
<b>Test result(s)</b>	<p>Measurement record:</p> <table border="1" data-bbox="411 958 1321 1093"> <thead> <tr> <th rowspan="2">Interferer centre frequency [MHz]</th> <th colspan="3">I/C [dB]</th> </tr> <tr> <th>708.0</th> <th>718.0</th> <th>728.0</th> </tr> </thead> <tbody> <tr> <td>8K, 64-QAM, R=2/3, <math>\Delta/Tu = 1/8</math>, 8MHz</td> <td></td> <td></td> <td></td> </tr> <tr> <td>8K, 64-QAM, R=3/4, <math>\Delta/Tu = 1/4</math>, 8MHz</td> <td></td> <td></td> <td></td> </tr> </tbody> </table> <p>Table 1. UE Video stream traffic interferer</p> <table border="1" data-bbox="411 1149 1321 1283"> <thead> <tr> <th rowspan="2">Interferer centre frequency [MHz]</th> <th colspan="3">I/C [dB]</th> </tr> <tr> <th>763.0</th> <th>773.0</th> <th>783.0</th> </tr> </thead> <tbody> <tr> <td>8K, 64-QAM, R=2/3, <math>\Delta/Tu = 1/8</math>, 8MHz</td> <td></td> <td></td> <td></td> </tr> <tr> <td>8K, 64-QAM, R=3/4, <math>\Delta/Tu = 1/4</math>, 8MHz</td> <td></td> <td></td> <td></td> </tr> </tbody> </table> <p>Table 2. BS 0% traffic load interferer</p>	Interferer centre frequency [MHz]	I/C [dB]			708.0	718.0	728.0	8K, 64-QAM, R=2/3, $\Delta/Tu = 1/8$ , 8MHz				8K, 64-QAM, R=3/4, $\Delta/Tu = 1/4$ , 8MHz				Interferer centre frequency [MHz]	I/C [dB]			763.0	773.0	783.0	8K, 64-QAM, R=2/3, $\Delta/Tu = 1/8$ , 8MHz				8K, 64-QAM, R=3/4, $\Delta/Tu = 1/4$ , 8MHz			
Interferer centre frequency [MHz]	I/C [dB]																														
	708.0	718.0	728.0																												
8K, 64-QAM, R=2/3, $\Delta/Tu = 1/8$ , 8MHz																															
8K, 64-QAM, R=3/4, $\Delta/Tu = 1/4$ , 8MHz																															
Interferer centre frequency [MHz]	I/C [dB]																														
	763.0	773.0	783.0																												
8K, 64-QAM, R=2/3, $\Delta/Tu = 1/8$ , 8MHz																															
8K, 64-QAM, R=3/4, $\Delta/Tu = 1/4$ , 8MHz																															
<b>Conformity</b>	<input type="checkbox"/> <b>OK</b> <input type="checkbox"/> <b>Fault</b> <input type="checkbox"/> Major <input type="checkbox"/> Minor, define fail reason in comments																														
<b>Comments</b>	<p>If possible describe if fault can be fixed with software update: <input type="checkbox"/> <b>YES</b> <input type="checkbox"/> <b>NO</b></p> <p>Describe more specific faults and/or other information</p>																														
<b>Date</b>	<table border="1" style="width: 100%;"> <tr> <td style="width: 50%;"></td> <td style="width: 20%; text-align: center;"><b>Sign</b></td> <td style="width: 30%;"></td> </tr> </table>		<b>Sign</b>																												
	<b>Sign</b>																														

<b>Test Case</b>	<b>Task 3:27 Performance: Immunity to “LTE 800 MHz” signals in Other Channels</b>
<b>Section</b>	NorDig Unified 3.4.10.7.1
<b>Requirement</b>	<p>The DVB-T and DVB-T2 IRD shall, for the supported frequency ranges, permit an interfering LTE signal with a minimum interference to signal level ratio (I/C) as stated in the table below while maintaining QEF reception.</p> <p>The power of the LTE signal, both BS and UE, varies with a traffic load. The signal power of the LTE signal is defined as the power during the active part of the time varying LTE signal. The I/C values shall be fulfilled for traffic loads 0% to 100 % (BS) and for traffic loads from low bit rate to high bit rate (UE). Low traffic loads can be the most demanding ones. The minimum I/C requirement shall be fulfilled for -15dBm</p>

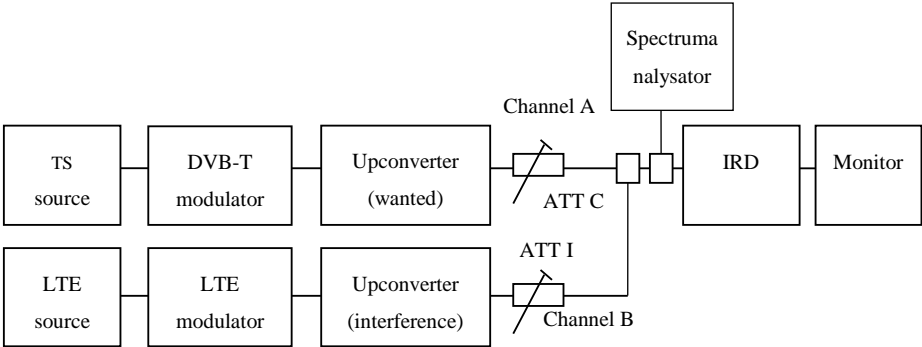
	<p>defined as licensed power of interfering signal, at the input of the IRD.</p> <p>The requirements in this paragraph refer, for DVB-T, to the modes {8K, 64-QAM, R=2/3, <math>\Delta/Tu = 1/8</math>, 8MHz} and {8K, 64-QAM, R=2/3, <math>\Delta/Tu = 1/4</math>, 8MHz} and {8K, 64-QAM, R=3/4, <math>\Delta/Tu = 1/4</math>, 8MHz} and for DVB-T2 to the modes {32KE, 256-QAM R, PP4, R=2/3, <math>\Delta/Tu = 1/16</math>, 8MHz} {32KE, 256-QAM R, PP4, R=3/5, <math>\Delta/Tu = 19/256</math>, 8MHz} {32KN, 256-QAM R, PP4, R=2/3, <math>\Delta/Tu = 19/256</math>, 7MHz} and</p>
<p><b>IRD Profile(s)</b></p>	<p>Basic, IRD, DVB-T</p>
<p><b>Test procedure</b></p>	<p><b>Purpose of test:</b> To verify the QEF reception for LTE signal interference on adjacent or other channels.</p> <p><b>Equipment:</b></p>  <p>Verify that the interfering LTE signal on the adjacent or the other channels don't have too high shoulders, which could cause out-of-band emissions in the reception of the wanted digital TV signal.</p> <p>From IRD point of view most demanding LTE signal might be that with low traffic load.</p> <p>The LTE transmission is generated by using following LTE signal characteristics:          LTE_BS-idle_V2.wv (BS 0% traffic load)          LTE_UE_1Mbs_V2.wv (UE 1 MBit/s traffic load)          Files in I/Q file format are available on NorDig homepage.</p> <p>Use Mode A (Single PLP) and <math>L_f</math> parameter settings defined by Teracom for the modes.</p> <p><b>Test procedure:</b></p> <ol style="list-style-type: none"> <li>1. Set up the test instruments</li> <li>2. Use the following DVB-T mode {8K, 64-QAM, R=2/3, <math>\Delta/Tu = 1/8</math>, 8MHz}</li> <li>3. Set the channel A up-converter to 786.0MHz (K60).</li> <li>4. Set the channel B up-converter to 796.0MHz .</li> <li>5. Set the LTE interfere to BS 0% traffic load mode.</li> <li>6. Set the receiver input level for the LTE signal in channel B to -15 dBm.</li> <li>7. Decrease the wanted signal level in channel A to a signal level when the quality measurement procedure 2 is still fulfilled.</li> <li>8. Fill in the measured signal level difference between channel A and channel B signals in dB in measurement record.</li> <li>9. Repeat the test when the channel B up-converter is set to frequencies 806.0 MHz, 816.0 MHz.</li> </ol>

	<p>10. Set the channel B up-converter to 837.0MHz.          11. Set the LTE interferer to UE 1 MBit/s traffic load mode.          12. Set the receiver input level for the LTE signal in channel B to -15 dBm.          13. Decrease the wanted signal level in channel A to a signal level when the quality measurement procedure 2 is still fulfilled.          14. Fill in the measured signal level difference between channel A and channel B signals in dB in measurement record.          15. Repeat the test when the channel B up-converter is set to frequencies 847.0 MHz, 857.0 MHz.          16. Repeat the test for the DVB-T mode {8K, 64-QAM, R=2/3, <math>\Delta/T_u = 1/4</math>, 8MHz}.          17. Repeat the test for the DVB-T mode {8K, 64-QAM, R=3/4, <math>\Delta/T_u = 1/4</math>, 8MHz}.</p> <p><b>Expected result:</b></p> <p>The wanted DVB-T signal shall be QEF for the interference signal levels as specified.</p>																																								
<b>Test result(s)</b>	<p>Measurement record:</p> <table border="1" style="margin-left: 40px;"> <thead> <tr> <th></th> <th colspan="3">I/C [dB]</th> </tr> </thead> <tbody> <tr> <td>Interferer centre frequency [MHz]</td> <td>796.0</td> <td>806.0</td> <td>816.0</td> </tr> <tr> <td>8K, 64-QAM, R=2/3, <math>\Delta/T_u = 1/8</math>, 8MHz</td> <td></td> <td></td> <td></td> </tr> <tr> <td>8K, 64-QAM, R=2/3, <math>\Delta/T_u = 1/4</math>, 8MHz</td> <td></td> <td></td> <td></td> </tr> <tr> <td>8K, 64-QAM, R=3/4, <math>\Delta/T_u = 1/4</math>, 8MHz</td> <td></td> <td></td> <td></td> </tr> </tbody> </table> <p>Table 1. BS 0% interferer</p> <table border="1" style="margin-left: 40px;"> <thead> <tr> <th></th> <th colspan="3">I/C [dB]</th> </tr> </thead> <tbody> <tr> <td>Interferer centre frequency [MHz]</td> <td>837.0</td> <td>847.0</td> <td>857.0</td> </tr> <tr> <td>8K, 64-QAM, R=2/3, <math>\Delta/T_u = 1/8</math>, 8MHz</td> <td></td> <td></td> <td></td> </tr> <tr> <td>8K, 64-QAM, R=2/3, <math>\Delta/T_u = 1/4</math>, 8MHz</td> <td></td> <td></td> <td></td> </tr> <tr> <td>8K, 64-QAM, R=3/4, <math>\Delta/T_u = 1/4</math>, 8MHz</td> <td></td> <td></td> <td></td> </tr> </tbody> </table> <p>Table 2. UE 1 Mbit/s interferer</p>		I/C [dB]			Interferer centre frequency [MHz]	796.0	806.0	816.0	8K, 64-QAM, R=2/3, $\Delta/T_u = 1/8$ , 8MHz				8K, 64-QAM, R=2/3, $\Delta/T_u = 1/4$ , 8MHz				8K, 64-QAM, R=3/4, $\Delta/T_u = 1/4$ , 8MHz					I/C [dB]			Interferer centre frequency [MHz]	837.0	847.0	857.0	8K, 64-QAM, R=2/3, $\Delta/T_u = 1/8$ , 8MHz				8K, 64-QAM, R=2/3, $\Delta/T_u = 1/4$ , 8MHz				8K, 64-QAM, R=3/4, $\Delta/T_u = 1/4$ , 8MHz			
	I/C [dB]																																								
Interferer centre frequency [MHz]	796.0	806.0	816.0																																						
8K, 64-QAM, R=2/3, $\Delta/T_u = 1/8$ , 8MHz																																									
8K, 64-QAM, R=2/3, $\Delta/T_u = 1/4$ , 8MHz																																									
8K, 64-QAM, R=3/4, $\Delta/T_u = 1/4$ , 8MHz																																									
	I/C [dB]																																								
Interferer centre frequency [MHz]	837.0	847.0	857.0																																						
8K, 64-QAM, R=2/3, $\Delta/T_u = 1/8$ , 8MHz																																									
8K, 64-QAM, R=2/3, $\Delta/T_u = 1/4$ , 8MHz																																									
8K, 64-QAM, R=3/4, $\Delta/T_u = 1/4$ , 8MHz																																									
<b>Conformity</b>	<input type="checkbox"/> <b>OK</b> <input type="checkbox"/> <b>Fault</b> <input type="checkbox"/> Major <input type="checkbox"/> Minor, define fail reason in comments																																								
<b>Comments</b>	<p>If possible describe if fault can be fixed with software update: <input type="checkbox"/> <b>YES</b> <input type="checkbox"/> <b>NO</b>          Describe more specific faults and/or other information</p>																																								
<b>Date</b>	<b>Sign</b>																																								

<b>Test Case</b>	<b>Task 3:28 Performance: Performance in Time-Varying Channels</b>
<b>Section</b>	NorDig Unified 3.4.10.9
<b>Requirement</b>	<p>The NorDig IRD shall be able to operate with all signal time variations that naturally exist in connection with fixed roof-top reception (e.g. mast sway, antenna sway) and in-house portable reception (e.g. people walking around the receiving antenna). None of the above mentioned performance parameters should be significantly negatively affected when such channel time variations exist.</p> <p>The increase in required C/N for QEF reception shall be less than 3 dB for a 0 dB echo with frequency separation equal to 20 Hz and a delay of 20 <math>\mu</math>s, corresponding to a Doppler shift of +/- 10 Hz (after AFC), compared to a 0 dB echo with frequency separation equal to 1 Hz and a delay of 20 <math>\mu</math>s, corresponding to a Doppler shift of +/- 0.5 Hz (after AFC). The requirements in this paragraph refer to the modes {8K, 64-</p>

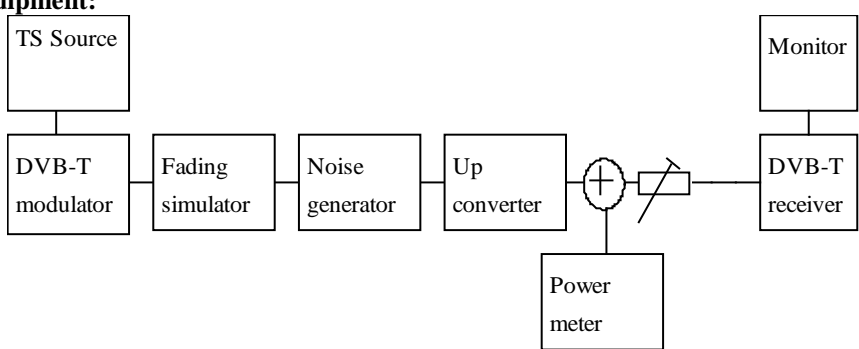

	<p>QAM, <math>R=2/3</math>, <math>\Delta/T_U=1/8</math>} and {8K, 64-QAM, <math>R=2/3</math>, <math>\Delta/T_U=1/4</math>}.</p> <p>The increase in required C/N for QEF reception shall be less than 3 dB for a 0 dB echo with frequency separation equal to 10 Hz and a delay of 20 <math>\mu</math>s, corresponding to a Doppler shift of <math>\pm 5</math> Hz (after AFC), compared to a 0 dB echo with frequency separation equal to 1 Hz and a delay of 20 <math>\mu</math>s, corresponding to a Doppler shift of <math>\pm 0.5</math> Hz (after AFC). The requirement in this paragraph refer to the mode {8K, 64-QAM, <math>R=3/4</math>, <math>\Delta/T_U=1/4</math>}.</p>
<p><b>IRD profile(s)</b></p>	<p>Basic, IRD, DVB-T</p>
<p><b>Test procedure</b></p>	<p><b>Purpose of test:</b> To verify the reception on a channel where time variations exists.</p> <p><b>Equipment:</b></p>  <p>The 0 degree channel center shall be used in fading simulator . This is valid for 0Hz doppler shift.</p> <p><b>Test procedure:</b></p> <ol style="list-style-type: none"> <li>1. Set up the test instruments.</li> <li>2. Use the following mode: {8K, 64-QAM, <math>R=2/3</math>, <math>\Delta/T_U=1/8</math>}.</li> <li>3. Use channel 45.</li> <li>4. Configure path 1 to type of static, attenuation 0dB, delay 0<math>\mu</math>s.</li> <li>5. Configure path 2 to type of pure Doppler, attenuation 0dB, delay 20<math>\mu</math>s and frequency separation to 0Hz.</li> <li>6. Set the receiver input level to -50 dBm.</li> <li>7. Increase the C/N from low value to higher value until the quality measurement procedure 2 (QMP2) is fulfilled.</li> <li>8. Fill in the measured value in dB in the measurement record.</li> <li>9. Repeat the test for the rest of the frequency separation values in the measurement record. Be careful of value which is configured in fading simulator. It can be speed, Doppler or frequency separation.</li> <li>10. Fill the C/N result in the measurement record.</li> <li>11. Repeat the test for the DVB-T modes {8K, 64-QAM, <math>R=2/3</math>, <math>\Delta/T_U=1/4</math>} and {8K, 64-QAM, <math>R=3/4</math>, <math>\Delta/T_U=1/4</math>}.</li> </ol> <p><b>Expected result:</b> For the DVB-T modes {8K, 64-QAM, <math>R=2/3</math>, <math>\Delta/T_U=1/8</math>} and {8k, 64QAM, <math>R=2/3</math>, <math>\Delta/T_U=1/4</math>} the increase in the required C/N shall be less than 3dB for 0dB 20<math>\mu</math>s echo from frequency separation 1Hz to 20Hz. For the mode {8K, 64-QAM, <math>R=3/4</math>, <math>\Delta/T_U=1/4</math>} the increase in the required C/N shall be less than 3dB for 0dB 20<math>\mu</math>s echo from frequency separation 1Hz to 10Hz.</p>
<p><b>Test result(s)</b></p>	<p>Measurement record:</p>

Mode	0dB echo delay [ $\mu$ s]	Frequency separation [Hz]	C/N [dB]
{8K, 64-QAM, R=2/3, $\Delta/T_U=1/8$ }	20 $\mu$ s	0Hz	
{8K, 64-QAM, R=2/3, $\Delta/T_U=1/8$ }	20 $\mu$ s	1Hz	
{8K, 64-QAM, R=2/3, $\Delta/T_U=1/8$ }	20 $\mu$ s	5Hz	
{8K, 64-QAM, R=2/3, $\Delta/T_U=1/8$ }	20 $\mu$ s	10Hz	
{8K, 64-QAM, R=2/3, $\Delta/T_U=1/8$ }	20 $\mu$ s	15Hz	
{8K, 64-QAM, R=2/3, $\Delta/T_U=1/8$ }	20 $\mu$ s	20Hz	
{8K, 64-QAM, R=2/3, $\Delta/T_U=1/4$ }	20 $\mu$ s	0Hz	
{8K, 64-QAM, R=2/3, $\Delta/T_U=1/4$ }	20 $\mu$ s	1Hz	
{8K, 64-QAM, R=2/3, $\Delta/T_U=1/4$ }	20 $\mu$ s	5Hz	
{8K, 64-QAM, R=2/3, $\Delta/T_U=1/4$ }	20 $\mu$ s	10Hz	
{8K, 64-QAM, R=2/3, $\Delta/T_U=1/4$ }	20 $\mu$ s	15Hz	
{8K, 64-QAM, R=2/3, $\Delta/T_U=1/4$ }	20 $\mu$ s	20Hz	
{8K, 64-QAM, R=3/4, $\Delta/T_U=1/4$ }	20 $\mu$ s	0Hz	
{8K, 64-QAM, R=3/4, $\Delta/T_U=1/4$ }	20 $\mu$ s	1Hz	
{8K, 64-QAM, R=3/4, $\Delta/T_U=1/4$ }	20 $\mu$ s	5Hz	
{8K, 64-QAM, R=3/4, $\Delta/T_U=1/4$ }	20 $\mu$ s	10Hz	

<b>Conformity</b>	<input type="checkbox"/> OK Fault <input type="checkbox"/> Major <input type="checkbox"/> Minor, define fail reason in comments		
<b>Comments</b>	If possible describe if fault can be fixed with software update: <input type="checkbox"/> YES <input type="checkbox"/> NO Describe more specific faults and/or other information		
<b>Date</b>		<b>Sign</b>	

<b>Test Case</b>	<b>Task 3:29 Performance: Synchronisation for varying echo power levels in SFN</b>
<b>Section</b>	NorDig Unified 3.4.10.10
<b>Requirement</b>	For the modes {8K, 64-QAM, R=2/3, $\Delta/T_U=1/8$ }, {8K, 64-QAM, R=2/3, $\Delta/T_U=1/4$ } and {8K, 64-QAM, R=3/4, $\Delta/T_U=1/4$ }, the required C/N value for subjective error free reception shall be obtained when the channel contains two paths with relative delay from 1.95 $\mu$ s up to 0.95 times guard interval length and the relative power levels of the two paths are dynamically varying including 0dB echo level crossing. The C/N value is defined at 0 dB level crossing.
<b>IRD profile(s)</b>	Basic, IRD, DVB-T
<b>Test procedure</b>	<b>Purpose of test:</b> To verify the SFN synchronisation when the amplitude of the echo compared to the amplitude of the direct signal varies in a function of time.  <b>Equipment:</b>

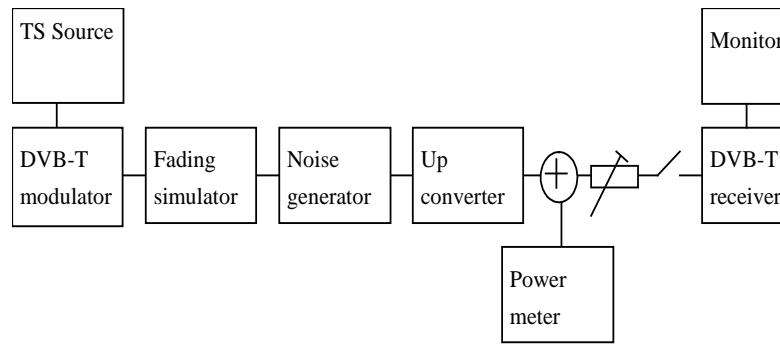

The 0 degree channel center shall be used in fading simulator (see2.3.5).

**Test procedure for variations of the echo attenuation in a function of time:**

Check the different SFN synchronisation issues from 2.3.4 Receiver operability in SFN.

1. Set up the test instruments.
2. Use the following mode {8K, 64-QAM, R=3/4,  $\Delta/T_U=1/4$ }.
3. Open the switch.
4. Configure the first path signal (direct) with following parameters: 0dB attenuation and 0 $\mu$ s delay.
5. Configure the second path signal (1<sup>st</sup> echo) with following parameters: 0dB attenuation and first delay value from the measurement record. .
6. Set the receiver input level to -50 dBm.
7. Configure the third path signal (2nd echo) with following parameters: 1dB attenuation and delay same as for the second path and 0.1Hz frequency separation.
8. Close the switch.
9. Increase the C/N from low value to higher value until the quality measurement procedure 2 (QMP2) is fulfilled.
10. Fill in the measured required C/N value in dB in the measurement record.
11. Repeat the test for the rest of the echo delay values in the measurement record following the procedure above. Between change of the echo delay, RF input signal to the receiver shall be disconnect.
12. Repeat the test for the DVB-T modes {8K, 64-QAM, R=2/3,  $\Delta/T_U=1/8$ } and {8K, 64-QAM, R=2/3,  $\Delta/T_U=1/4$ }.

**Expected result:**

The IRD shall maintain the SFN synchronisation when the amplitude of the echo signal varies in a function of time. The required C/N shall not exceed the specified value in table 3.18.

**Test result(s)**

Measurement record:

F = 666.0 MHz (K45) and signal bandwidth 8 MHz.							
Mode	10 $\mu$ s	56 $\mu$ s	105 $\mu$ s	112.1 $\mu$ s	130 $\mu$ s	170 $\mu$ s	212 $\mu$ s
8k 64QAM R2/3 G1/8							
8k 64QAM R3/4 G1/4							
8k 64QAM R2/3 G1/4							

**Conformity**

OK Fault  Major  Minor, define fail reason in comments

**Comments**

If possible describe if fault can be fixed with software update:  YES  NO  
Describe more specific faults and/or other information

<i>Date</i>		<i>Sign</i>	
-------------	--	-------------	--

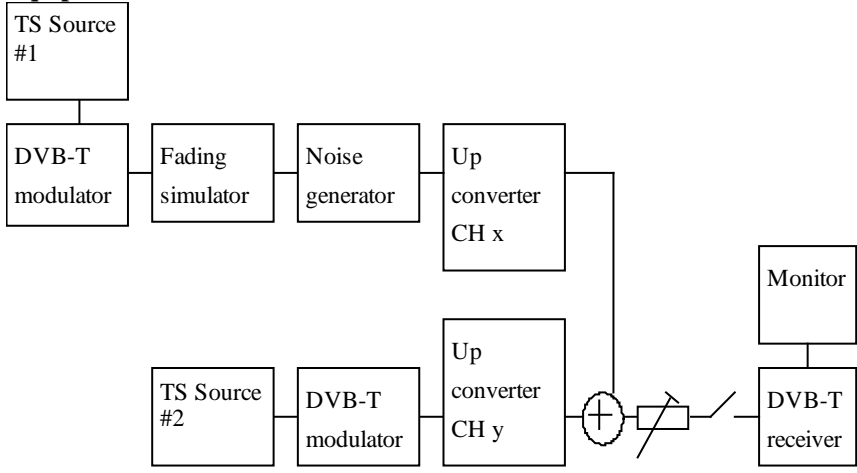
<i>Test Case</i>	<b>Task 3:30 Performance: C/(N+I) Performance in SFN for more than one echo</b>
<i>Section</i>	NorDig Unified 3.4.10.11
<i>Requirement</i>	<p>If there exists one or more FFT window positions for the time synchronisation that will give an aggregate available C/(N+I) larger than or equal to the required EPT (Effective Protection Target), the NorDig IRD shall be able to find one of these positions, independently of echo profile. The NorDig IRD shall also be able to correctly equalise the signal for echoes up to <math>7T_U/24</math> (260 <math>\mu</math>s) (Interval of correct equalisation), independently of the echo profile.</p> <p><sup>1)</sup> EPT = Effective Protection Target</p>
<i>IRD profile(s)</i>	Basic, IRD, DVB-T
<i>Test procedure</i>	<p><b>Purpose of test:</b></p> <p>To verify the SFN synchronization of the receiver when two echo signals are present.</p> <p><b>Equipment:</b></p>  <p>The 0 degree at channel center shall be used in fading simulator (see 2.3.5).</p> <p><b>Test procedure:</b></p> <p>Check the different SFN synchronisation issues from 2.3.4 Receiver operability in SFN.</p> <ol style="list-style-type: none"> <li>1. Set up the test instruments.</li> <li>2. Use the following DVB-T mode {8K, 64-QAM, R=3/4, <math>\Delta/T_U=1/4</math>} and signal bandwidth 8MHz.</li> <li>3. Open the switch.</li> <li>4. Configure one path of the channel simulator to have a 0dB attenuation, 0<math>\mu</math>s delay and 0 degree phase.</li> <li>5. Configure the second path of the channel simulator to have relative delay difference -100.1<math>\mu</math>s and attenuation 21dB (pre echo) and 0 degree phase.</li> <li>6. Configure the third path of the channel simulator to have relative delay difference +100.0<math>\mu</math>s and attenuation 15 dB (post echo) and 0 degree phase.</li> <li>7. Set the receiver input level to -50 dBm.</li> <li>8. Close the switch.</li> <li>9. Increase the required C/N value from low value to higher value until the quality</li> </ol>

- measurement procedure 2 (QMP2) is fulfilled.
10. Fill in the required C/N value in dB in the measurement record.
  11. Measure the rest of the required C/N values starting at the bottom of the table and upward.
  12. Fill in the results in the measurement record. During the change of the delay and the attenuation, the input RF signal to receiver shall be disconnected.
  13. Repeat the test for the DVB-T mode {8K, 64-QAM, R=2/3,  $\Delta/T_U = 1/8$ }.
  14. Repeat the test for the DVB-T mode {8K, 64-QAM, R=2/3,  $\Delta/T_U = 1/4$ }.

**Expected result:**

The IRD shall synchronize in all combinations defined in measurement record and the required C/N value shall not exceed the required C/N defined for profile 2: 0dB echo in table 3.9.

*Test result(s)*

Measurement record:

8k 64QAM R=3/4 $\Delta/T_U=1/4$ , 8MHz						
Main path		Pre echo		Post echo		C/N [dB]
Att [dB]	Delay [us]	Att [dB]	Delay [us]	Att [dB]	Delay [us]	
0	0	0	-100.1	0	100	
0	0	3	-100.1	3	100	
0	0	6	-100.1	6	100	
0	0	9	-100.1	9	100	
0	0	12	-100.1	12	100	
0	0	15	-100.1	15	100	
0	0	18	-100.1	18	100	
0	0	21	-100.1	21	100	
0	0	15	-100.1	0	100	
0	0	15	-100.1	3	100	
0	0	15	-100.1	6	100	
0	0	15	-100.1	9	100	
0	0	15	-100.1	12	100	
0	0	15	-100.1	18	100	
0	0	15	-100.1	21	100	
0	0	0	-100.1	15	100	
0	0	3	-100.1	15	100	
0	0	6	-100.1	15	100	
0	0	9	-100.1	15	100	
0	0	12	-100.1	15	100	
0	0	18	-100.1	15	100	
0	0	21	-100.1	15	100	

8k 64QAM R=2/3 $\Delta/T_U=1/8$ , 8MHz						
Main path		Pre echo		Post echo		C/N [dB]
Att [dB]	Delay [us]	Att [dB]	Delay [us]	Att [dB]	Delay [us]	
0	0	0	-50.1	0	50	
0	0	3	-50.1	3	50	
0	0	6	-50.1	6	50	
0	0	9	-50.1	9	50	
0	0	12	-50.1	12	50	

0	0	15	-50.1	15	50	
0	0	18	-50.1	18	50	
0	0	21	-50.1	21	50	
0	0	15	-50.1	0	50	
0	0	15	-50.1	3	50	
0	0	15	-50.1	6	50	
0	0	15	-50.1	9	50	
0	0	15	-50.1	12	50	
0	0	15	-50.1	18	50	
0	0	15	-50.1	21	50	
0	0	0	-50.1	15	50	
0	0	3	-50.1	15	50	
0	0	6	-50.1	15	50	
0	0	9	-50.1	15	50	
0	0	12	-50.1	15	50	
0	0	15	-50.1	15	50	
0	0	18	-50.1	15	50	
0	0	21	-50.1	15	50	

8k 64QAM R=2/3 Δ/T <sub>1</sub> =1/4, 8MHz						
Main path		Pre echo		Post echo		C/N [dB]
Att [dB]	Delay [us]	Att [dB]	Delay [us]	Att [dB]	Delay [us]	
0	0	0	-100.1	0	100	
0	0	3	-100.1	3	100	
0	0	6	-100.1	6	100	
0	0	9	-100.1	9	100	
0	0	12	-100.1	12	100	
0	0	15	-100.1	15	100	
0	0	18	-100.1	18	100	
0	0	21	-100.1	21	100	
0	0	15	-100.1	0	100	
0	0	15	-100.1	3	100	
0	0	15	-100.1	6	100	
0	0	15	-100.1	9	100	
0	0	15	-100.1	12	100	
0	0	15	-100.1	18	100	
0	0	15	-100.1	21	100	
0	0	0	-100.1	15	100	
0	0	3	-100.1	15	100	
0	0	6	-100.1	15	100	
0	0	9	-100.1	15	100	
0	0	12	-100.1	15	100	
0	0	18	-100.1	15	100	
0	0	21	-100.1	15	100	

<b>Conformity</b>	<input type="checkbox"/> OK Fault <input type="checkbox"/> Major <input type="checkbox"/> Minor, define fail reason in comments
<b>Comments</b>	If possible describe if fault can be fixed with software update: <input type="checkbox"/> YES <input type="checkbox"/> NO Describe more specific faults and/or other information

<i>Date</i>		<i>Sign</i>	

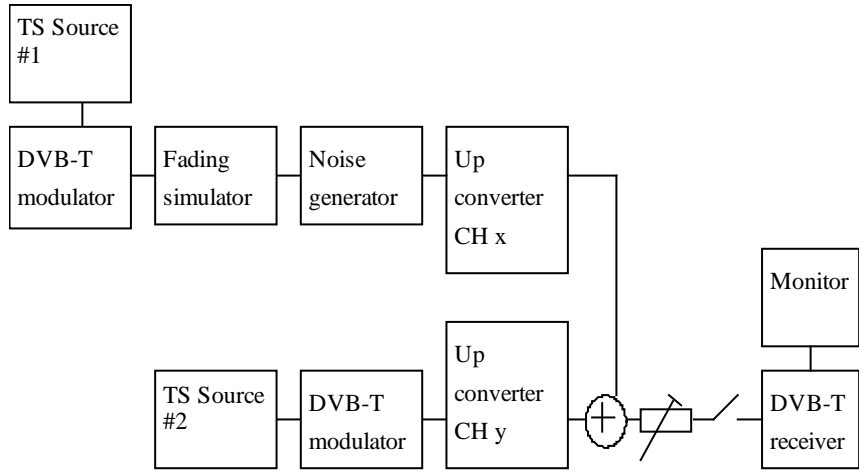
<b>Test Case</b>	<b>Task 3:31 Performance: C/(N+I) Performance in SFN inside the guard interval</b>
<b>Section</b>	NorDig Unified 3.4.10.11
<b>Requirement</b>	<p>For the modes {8K, 64-QAM, R=2/3, <math>\Delta/T_u=1/8</math>}, {8K, 64-QAM, R=2/3, <math>\Delta/T_u=1/4</math>} and {8K, 64-QAM, R=3/4, <math>\Delta/T_u=1/4</math>}, the required C/N value for profile 2 (specified in Table 3.10) for QEF reception shall be obtained when the channel contains two static paths with relative delay from 1.95 <math>\mu</math>s up to 0.95 times guard interval length, independently of the relative amplitudes and phases of the two paths.</p> <p>For specific echo attenuation, the required C/N shall not be more than 1 dB higher compared to the median value when calculated for the required C/N values over the echo delays from 1.95 <math>\mu</math>s up to 0.95 times guard interval length.</p>
<b>IRD profile(s)</b>	Basic, IRD, DVB-T
<b>Test procedure</b>	<p><b>Purpose of test:</b> To verify the required C/N for echoes in SFN inside the guard interval.</p> <p><b>Equipment:</b></p>  <p>The 0 degree channel center shall be used in fading simulator (see 2.3.5).</p> <p><b>Test procedure for required C/N in SFN for echoes inside guard interval:</b></p> <p>Check the different SFN synchronisation issues from 2.3.4 Receiver operability in SFN.</p> <ol style="list-style-type: none"> <li>1. Set up the test instruments.</li> <li>2. Use the following DVB-T mode {8K, 64-QAM, R=3/4, <math>\Delta/T_u=1/4</math>} and signal bandwidth 8MHz.</li> <li>3. Set the up-converter to center frequency 666MHz (K45).</li> <li>4. Open the switch.</li> <li>5. Set the receiver input level to -50 dBm for the wanted signal.</li> <li>6. Set the channel simulator relative delay difference to 1.95 <math>\mu</math>s for the echo signal.</li> <li>7. Set the channel simulator relative attenuation level to 0 dB for the echo signal.</li> </ol>













10											
11											
12											
13											
14											
15											
16											
17											
18											
19											
20											
21											
dB /us	-1.95	-10	-28	-64	-90	-128.1	-150	-170	-190	-243	-252
0											
1											
2											
3											
4											
5											
6											
7											
8											
9											
10											
11											
12											
13											
14											
15											
16											
17											
18											
19											
20											
21											
<b>Conformity</b>	<input type="checkbox"/> OK <input type="checkbox"/> Fault <input type="checkbox"/> Major <input type="checkbox"/> Minor, define fail reason in comments										
<b>Comments</b>	If possible describe if fault can be fixed with software update: <input type="checkbox"/> YES <input type="checkbox"/> NO Describe more specific faults and/or other information										
<b>Date</b>							<b>Sign</b>				

<b>Test Case</b>	<b>Task 3:32 Performance: C/(N+I) Performance in SFN outside the guard interval</b>
<b>Section</b>	NorDig Unified 3.4.10.11
<b>Requirement</b>	For echoes outside the guard interval, for 8MHz DVB-T signal, QEF reception shall be possible with echo levels up the values defined in Table 3.22  For echoes outside the guard interval, for 7MHz DVB-T signal, QEF reception shall be possible with echo levels up the values defined in Table 3.23.
<b>IRD profile(s)</b>	Basic, IRD, DVB-T
<b>Test procedure</b>	<b>Purpose of test:</b> To verify the SFN synchronisation in SFN for echoes outside guard interval.  <b>Equipment:</b>

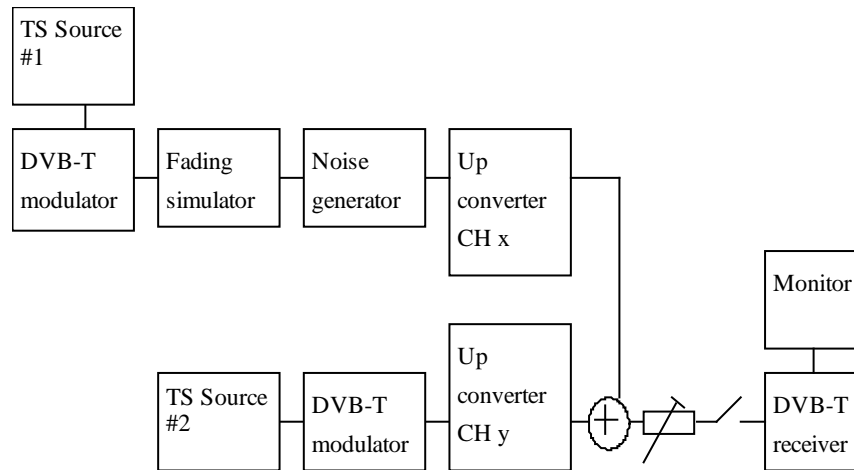

**Test procedure for evaluation of synchronization for echoes outside the guard interval:**

Check the different SFN synchronisation issues from 2.3.4 Receiver operability in SFN.

1. Set up the test instruments.
2. Use the following mode {8K, 64-QAM, R=3/4,  $\Delta/T_U=1/4$ } and signal bandwidth 8MHz.
3. Open the switch.
4. Set the receiver input level to -50 dBm for the wanted signal.
5. Set the channel simulator relative delay difference to 230us for the echo signal.
6. Close the switch.
7. Increase the echo attenuation from low value to higher value until quality measurement procedure 2 (QMP2) is fulfilled.
8. Fill in echo attenuation result in dB in the measurement record.
9. Repeat the test the rest of the combinations of the relative delays and attenuation levels defined in measurement record.. Open the switch before changing the delay and attenuation level.
10. Repeat the test for the DVB-T modes {8K, 64-QAM, R=2/3,  $\Delta/T_U=1/8$ } and {8K, 64-QAM, R=2/3,  $\Delta/T_U=1/4$ }.
11. Set the up-converter to center frequency 198.5MHz (K8).
12. Follow the test procedure and repeat the test for the 7 MHz signal bandwidth and DVB-T modes defined in the measurement record according to procedure above.

**Expected result:**

All the echo attenuation values shall be equal or lower compared to NorDig Unified values in tables 3.20 and 3.21.

*Test result(s)*

Measurement record:

7 MHz signal bandwidth							
DVB-T mode	Echo delay [µs]						
	-298	-266	-256	-215	-165	-135	-128
8k 64QAM R2/3 G1/8							
8k 64QAM R2/3 G1/4							
8k 64QAM R3/4 G1/4							
Echo delay [µs]							
	298	266	256	215	165	135	128
8k 64QAM R2/3 G1/8							
8k 64QAM R2/3 G1/4							

	<table border="1" style="margin-left: auto; margin-right: auto;"> <tr> <td style="width: 150px;">8k 64QAM R3/4 G1/4</td> <td style="width: 40px;"></td> <td style="width: 40px;"></td> <td style="width: 40px;"></td> <td style="width: 40px;"></td> <td style="width: 40px;"></td> <td style="width: 40px;"></td> <td style="width: 40px;"></td> </tr> </table>	8k 64QAM R3/4 G1/4																																																																
8k 64QAM R3/4 G1/4																																																																		
	<table border="1" style="margin-left: auto; margin-right: auto;"> <thead> <tr> <th colspan="6">8 MHz signal bandwidth</th> </tr> <tr> <th rowspan="2">DVB-T mode</th> <th colspan="5">Echo delay [<math>\mu</math>s]</th> </tr> <tr> <th>-260</th> <th>-230</th> <th>-200</th> <th>-150</th> <th>-120</th> </tr> </thead> <tbody> <tr> <td>8k 64QAM R2/3 G1/8</td> <td></td> <td></td> <td></td> <td></td> <td></td> </tr> <tr> <td>8k 64QAM R2/3 G1/4</td> <td></td> <td></td> <td style="background-color: #cccccc;"></td> <td style="background-color: #cccccc;"></td> <td style="background-color: #cccccc;"></td> </tr> <tr> <td>8k 64QAM R3/4 G1/4</td> <td></td> <td></td> <td style="background-color: #cccccc;"></td> <td style="background-color: #cccccc;"></td> <td style="background-color: #cccccc;"></td> </tr> <tr> <th></th> <th colspan="5">Echo delay [<math>\mu</math>s]</th> </tr> <tr> <th></th> <th>260</th> <th>230</th> <th>200</th> <th>150</th> <th>120</th> </tr> <tr> <td>8k 64QAM R2/3 G1/8</td> <td></td> <td></td> <td></td> <td></td> <td></td> </tr> <tr> <td>8k 64QAM R2/3 G1/4</td> <td></td> <td></td> <td style="background-color: #cccccc;"></td> <td style="background-color: #cccccc;"></td> <td style="background-color: #cccccc;"></td> </tr> <tr> <td>8k 64QAM R3/4 G1/4</td> <td></td> <td></td> <td style="background-color: #cccccc;"></td> <td style="background-color: #cccccc;"></td> <td style="background-color: #cccccc;"></td> </tr> </tbody> </table>	8 MHz signal bandwidth						DVB-T mode	Echo delay [ $\mu$ s]					-260	-230	-200	-150	-120	8k 64QAM R2/3 G1/8						8k 64QAM R2/3 G1/4						8k 64QAM R3/4 G1/4							Echo delay [ $\mu$ s]						260	230	200	150	120	8k 64QAM R2/3 G1/8						8k 64QAM R2/3 G1/4						8k 64QAM R3/4 G1/4					
8 MHz signal bandwidth																																																																		
DVB-T mode	Echo delay [ $\mu$ s]																																																																	
	-260	-230	-200	-150	-120																																																													
8k 64QAM R2/3 G1/8																																																																		
8k 64QAM R2/3 G1/4																																																																		
8k 64QAM R3/4 G1/4																																																																		
	Echo delay [ $\mu$ s]																																																																	
	260	230	200	150	120																																																													
8k 64QAM R2/3 G1/8																																																																		
8k 64QAM R2/3 G1/4																																																																		
8k 64QAM R3/4 G1/4																																																																		
<b>Conformity</b>	<input type="checkbox"/> <b>OK Fault</b> <input type="checkbox"/> Major <input type="checkbox"/> Minor, define fail reason in comments																																																																	
<b>Comments</b>	If possible describe if fault can be fixed with software update: <input type="checkbox"/> <b>YES</b> <input type="checkbox"/> <b>NO</b> Describe more specific faults and/or other information																																																																	
<b>Date</b>	<table border="1" style="margin-left: auto; margin-right: auto;"> <tr> <td style="width: 150px;"></td> <td style="width: 80px; text-align: center;"><i>Sign</i></td> </tr> </table>		<i>Sign</i>																																																															
	<i>Sign</i>																																																																	

**2.3.9.2 Test cases – DVB-T2**

<b>Test Case</b>	<b>Task 3:33 DVB-T2: Frequencies: Center frequencies</b>					
<b>Section</b>	NorDig Unified 3.4.2.2					
<b>Requirement</b>	<p>The front-end shall for the supported frequency ranges be capable of tuning to the center frequency <math>f_c</math> of the incoming DVB-T/T2 RF signal, see below and NorDig Specification :</p> <p><u>8 MHz raster:</u>  <math>f_c = 114 \text{ MHz} + K * 8 \text{ MHz}</math>, where K is an integer number, running from 0 to 93.</p> <p><u>7 MHz raster:</u>  <math>f_c = 107.5 \text{ MHz} + L * 7 \text{ MHz}</math>, where L is an integer number, running from 0 to 27.</p> <p><u>1,7 MHz raster (DVB-T2):</u>  <math>f_c</math> shall be as specified in Annex B2.</p>					
<b>IRD Profile(s)</b>	Basic, IRD, DVB-T2					
<b>Test procedure</b>	<p><b>Purpose of test:</b>            To verify the reception over the supported frequency range.</p> <p><b>Equipment:</b></p> <div style="text-align: center;"> <table border="1" style="margin-left: auto; margin-right: auto;"> <tr> <td style="width: 100px; text-align: center;">TS source</td> <td style="width: 20px; text-align: center;">—</td> <td style="width: 100px; text-align: center;">DVB-T2 exciter</td> <td style="width: 20px; text-align: center;">—</td> <td style="width: 100px; text-align: center;">DVB-T2 receiver</td> </tr> </table> </div> <p>Use following DVB-T2 modes:</p> <ul style="list-style-type: none"> <li>VHF III 1.7 MHz signal bandwidth: 8k normal bandwidth, 64QAM rotated, G1/8, PP2, R3/4, L1-ACE &amp; TR PAPR</li> </ul>	TS source	—	DVB-T2 exciter	—	DVB-T2 receiver
TS source	—	DVB-T2 exciter	—	DVB-T2 receiver		

- VHF III 7 MHz signal bandwidth: 32k normal bandwidth, 256QAM rotated, GI1/8, PP2, R3/4, L1-ACE & TR PAPR
- VHF S I and S II, III and UHF S III 8 MHz signal bandwidth: 32k extended bandwidth, 256QAM rotated, GI1/16, PP4, R2/3, L1-ACE & TR PAPR
- UHF IV/V 8 MHz signal bandwidth: 32k extended bandwidth, 256QAM rotated, GI1/16, PP4, R2/3, L1-ACE & TR PAPR

**Test procedure:**

1. Set up the test instruments
2. Use the corresponding DVB-T2 mode from list above.
3. Use input level of -50 dBm
4. Start with frequency 177.5 MHz (K5)
5. Use the quality measurement procedures 1 (QMP1)
6. Fill the result in the measurement record: **OK** or **NOK**.
7. Repeat the test for all channels in the table 1 and table 2 in the measurement record.
8. If the receiver supports optional frequency ranges, test all remaining channels in table 3 and 4 in the measurement record.

**Expected result:**

The result of the test shall be OK for all channels in table 1 in test results.

*Test result(s)*

Band	Channel	Frequency [MHz]	BW [MHz]	Result OK or NOK	
VHF III	K5	177.5	7		
	K6	184.5	7		
	K7	191.5	7		
	K8	198.5	7		
	K9	205.5	7		
	K10	212.5	7		
	K11	219.5	7		
	K12	226.5	7		
	UHF IV/V	K21	474	8	
		K22	482	8	
		K23	490	8	
		K24	498	8	
K25		506	8		
K26		514	8		
K27		522	8		
K28		530	8		
K29		538	8		
K30		546	8		
K31		554	8		
K32		562	8		
K33		570	8		
K34		578	8		
K35		586	8		
K36		594	8		
K37		602	8		
K38		610	8		
K39		618	8		
K40		626	8		
K41		634	8		
K42		642	8		
K43		650	8		
K44		658	8		
K45		666	8		
K46		674	8		
K47		682	8		
K48		690	8		



K49	698	8	
K50	706	8	
K51	714	8	
K52	722	8	
K53	730	8	
K54	738	8	
K55	746	8	
K56	754	8	
K57	762	8	
K58	770	8	
K59	778	8	
K60	786	8	
K61	794	8	
K62	802	8	
K63	810	8	
K64	818	8	
K65	826	8	
K66	834	8	
K67	842	8	
K68	850	8	
K69	858	8	

Table 1. Mandatory center frequencies and signal bandwidths to receive

Band	Channel	Frequency [MHz]	BW [MHz]	Result OK or NOK
VHF III	5A	174.928	1.7	
	5B	176.640	1.7	
	5C	178.352	1.7	
	5D	180.064	1.7	
	6A	181.936	1.7	
	6B	183.648	1.7	
	6C	185.360	1.7	
	6D	187.072	1.7	
	7A	188.928	1.7	
	7B	190.640	1.7	
	7C	192.352	1.7	
	7D	194.064	1.7	
	8A	195.936	1.7	
	8B	197.648	1.7	
	8C	199.360	1.7	
	8D	201.072	1.7	
	9A	202.928	1.7	
	9B	204.640	1.7	
	9C	206.352	1.7	
	9D	208.064	1.7	
	10A	209.936	1.7	
	10B	211.648	1.7	
	10C	213.360	1.7	
	10D	215.072	1.7	
	11A	216.928	1.7	
	11B	218.640	1.7	
	11C	220.352	1.7	
	11D	222.064	1.7	
	12A	223.936	1.7	
	12B	225.648	1.7	
12C	227.360	1.7		
12D	229.072	1.7		
13A	230.784	1.7		
13B	232.496	1.7		
13C	234.208	1.7		
13D	235.776	1.7		
13E	237.488	1.7		
13F	239.200	1.7		

Table 2. Optional center frequencies and 1.7MHz signal bandwidths to receive

Band	Channel	Frequency [MHz]	BW [MHz]	Result 7MHz OK or NOK	BW [MHz]	Result 8MHz OK or NOK
VHF S I	D1	114.0	7		8	
	S2	114.5	7		8	
	S3	121.5	7		8	
	D2	122.0	7		8	
	S4	128.5	7		8	
	D3	130.0	7		8	
	S5	135.5	7		8	
	D4	138.0	7		8	
	S6	142.5	7		8	
	D5	146.0	7		8	
S7	149.5	7		8		
D6	154.0	7		8		
S8	156.5	7		8		
D7	162.0	7		8		
S9	163.5	7		8		
D8	170.0	7		8		
S10	170.5	7		8		
VHF III	K5	177.5	7		8	
	D9	178.0	7		8	
	K6	184.5	7		8	
	D10	186.0	7		8	
	K7	191.5	7		8	
	D11	194.0	7		8	
	K8	198.5	7		8	
	D12	202.0	7		8	
	K9	205.5	7		8	
	D13	210.0	7		8	
K10	212.5	7		8		
D14	218.0	7		8		
K11	219.5	7		8		
D15	226.0	7		8		
K12	226.5	7		8		
VHF S II	S11	233.5	7		8	
	D16	234.0	7		8	
	S12	240.5	7		8	
	D17	242.0	7		8	
	S13	247.5	7		8	
	D18	250.0	7		8	
	S14	254.5	7		8	
	D19	258.0	7		8	
	S15	261.5	7		8	
	D20	266.0	7		8	
	S16	268.5	7		8	
	D21	274.0	7		8	
	S17	275.5	7		8	
	D22	282.0	7		8	
S18	282.5	7		8		
S19	289.5	7		8		
D23	290.0	7		8		
S20	296.5	7		8		
D24	298.0	7		8		

Table 3 Optional VHF center frequencies and signal bandwidths to receive.

Band	Channel	Frequency [MHz]	BW [MHz]	Result OK or NOK
UHF S III	S21	306.0	8	
	S22	314.0	8	
	S23	322.0	8	
	S24	330.0	8	
	S25	338.0	8	
	S26	346.0	8	
	S27	354.0	8	
	S28	362.0	8	
	S29	370.0	8	
	S30	378.0	8	
	S31	386.0	8	

	S32	394.0	8	
	S33	402.0	8	
	S34	410.0	8	
	S35	418.0	8	
	S36	426.0	8	
	S37	434.0	8	
	S38	442.0	8	
	S39	450.0	8	
	S40	458.0	8	
	S41	466.0	8	

Table 4 Optional UHF center frequencies and signal bandwidth to receive.

<b>Conformity</b>	<input type="checkbox"/> OK Fault <input type="checkbox"/> Major <input type="checkbox"/> Minor, define fail reason in comments		
<b>Comments</b>	If possible describe if fault can be fixed with software update: <input type="checkbox"/> YES <input type="checkbox"/> NO Describe more specific faults and/or other information		
<b>Date</b>		<b>Sign</b>	

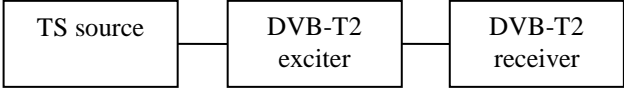
<b>Test Case</b>	<b>Task 3:34 DVB-T2: Frequencies: Frequency offset</b>
<b>Section</b>	NorDig Unified 3.4.2.3
<b>Requirement</b>	The NorDig IRD shall be able to receive signals with an offset of up to 50kHz from the nominal frequency.
<b>IRD Profile(s)</b>	Basic, IRD, DVB-T2
<b>Test procedure</b>	<p><b>Purpose of test:</b> To verify that the reception is possible in specified frequency offset from nominal frequency.</p> <p>Equipment:</p> <div style="text-align: center;">  <pre> graph LR     A[TS source] --- B[DVB-T2 exciter]     B --- C[DVB-T2 receiver]             </pre> </div> <p>Use following DVB-T2 modes:</p> <ul style="list-style-type: none"> <li>VHF III 1.7 MHz signal bandwidth: 8k normal bandwidth, 64QAM rotated, G1/8, PP2, R2/3, L1-ACE &amp; TR PAPR</li> <li>VHF III 7 MHz signal bandwidth: 32k normal bandwidth, 256QAM rotated, G1/8, PP2, R3/4, L1-ACE &amp; TR PAPR</li> <li>UHF IV/V 8 MHz signal bandwidth: 32k extended bandwidth, 256QAM rotated, G1/16, PP4, R2/3, L1-ACE &amp; TR PAPR</li> </ul> <p><b>Test procedure:</b></p> <ol style="list-style-type: none"> <li>Set up the test instruments</li> <li>Set the center frequency to 177.5 MHz and frequency offset to 0 kHz. Use signal bandwidth 7MHz.</li> <li>Use the corresponding DVB-T2 mode from the list above.</li> <li>Use input level of -50 dBm</li> <li>Connect receiver and do the channel search if needed.</li> <li>Test with the specified frequency offset values in the measurement record. Before changing the frequency offset, disconnect the receiver from the received RF signal.</li> </ol>

	<ol style="list-style-type: none"> <li>7. Do the change of frequency offset,</li> <li>8. Connect the received RF signal back to the receiver.</li> <li>9. Use the quality measurement procedure 1 (QMP1)</li> <li>10. Fill the result in the measurement record: <b>OK</b> or <b>NOK</b>.</li> <li>11. Test the remaining frequency offset values on specified center frequencies and signal bandwidths in the measurement record.</li> </ol> <p><b>Expected result:</b> The test shall be OK for all frequency offset values on specified center frequencies and signal bandwidths in table 1 in test results.</p>																																																																																								
<i>Test result(s)</i>	<table border="1" style="width: 100%; border-collapse: collapse; margin-bottom: 10px;"> <thead> <tr> <th>Channel</th> <th>Signal BW [MHz]</th> <th>Frequency [MHz]</th> <th>Offset [kHz]</th> <th>Result OK or NOK</th> </tr> </thead> <tbody> <tr> <td rowspan="3" style="text-align: center;">K5</td> <td style="text-align: center;">7</td> <td style="text-align: center;">177.5</td> <td style="text-align: center;">-50</td> <td></td> </tr> <tr> <td style="text-align: center;">7</td> <td style="text-align: center;">177.5</td> <td style="text-align: center;">0</td> <td></td> </tr> <tr> <td style="text-align: center;">7</td> <td style="text-align: center;">177.5</td> <td style="text-align: center;">+50</td> <td></td> </tr> <tr> <td rowspan="3" style="text-align: center;">K12</td> <td style="text-align: center;">7</td> <td style="text-align: center;">226.5</td> <td style="text-align: center;">-50</td> <td></td> </tr> <tr> <td style="text-align: center;">7</td> <td style="text-align: center;">226.5</td> <td style="text-align: center;">0</td> <td></td> </tr> <tr> <td style="text-align: center;">7</td> <td style="text-align: center;">226.5</td> <td style="text-align: center;">+50</td> <td></td> </tr> <tr> <td rowspan="3" style="text-align: center;">K21</td> <td style="text-align: center;">8</td> <td style="text-align: center;">474.0</td> <td style="text-align: center;">-50</td> <td></td> </tr> <tr> <td style="text-align: center;">8</td> <td style="text-align: center;">474.0</td> <td style="text-align: center;">0</td> <td></td> </tr> <tr> <td style="text-align: center;">8</td> <td style="text-align: center;">474.0</td> <td style="text-align: center;">+50</td> <td></td> </tr> <tr> <td rowspan="3" style="text-align: center;">K69</td> <td style="text-align: center;">8</td> <td style="text-align: center;">858.0</td> <td style="text-align: center;">-50</td> <td></td> </tr> <tr> <td style="text-align: center;">8</td> <td style="text-align: center;">858.0</td> <td style="text-align: center;">0</td> <td></td> </tr> <tr> <td style="text-align: center;">8</td> <td style="text-align: center;">858.0</td> <td style="text-align: center;">+50</td> <td></td> </tr> </tbody> </table> <p>Table 1. Mandatory center frequency offsets to receive.</p> <table border="1" style="width: 100%; border-collapse: collapse; margin-bottom: 10px;"> <thead> <tr> <th>Channel</th> <th>Signal BW [MHz]</th> <th>Frequency [MHz]</th> <th>Offset [kHz]</th> <th>Result OK or NOK</th> </tr> </thead> <tbody> <tr> <td rowspan="3" style="text-align: center;">5A</td> <td style="text-align: center;">1.7</td> <td style="text-align: center;">174.928</td> <td style="text-align: center;">-50</td> <td></td> </tr> <tr> <td style="text-align: center;">1.7</td> <td style="text-align: center;">174.928</td> <td style="text-align: center;">0</td> <td></td> </tr> <tr> <td style="text-align: center;">1.7</td> <td style="text-align: center;">174.928</td> <td style="text-align: center;">+50</td> <td></td> </tr> <tr> <td rowspan="3" style="text-align: center;">13F</td> <td style="text-align: center;">1.7</td> <td style="text-align: center;">239.200</td> <td style="text-align: center;">-50</td> <td></td> </tr> <tr> <td style="text-align: center;">1.7</td> <td style="text-align: center;">239.200</td> <td style="text-align: center;">0</td> <td></td> </tr> <tr> <td style="text-align: center;">1.7</td> <td style="text-align: center;">239.200</td> <td style="text-align: center;">+50</td> <td></td> </tr> </tbody> </table> <p>Table 2. Optional center frequency offsets to receive.</p>	Channel	Signal BW [MHz]	Frequency [MHz]	Offset [kHz]	Result OK or NOK	K5	7	177.5	-50		7	177.5	0		7	177.5	+50		K12	7	226.5	-50		7	226.5	0		7	226.5	+50		K21	8	474.0	-50		8	474.0	0		8	474.0	+50		K69	8	858.0	-50		8	858.0	0		8	858.0	+50		Channel	Signal BW [MHz]	Frequency [MHz]	Offset [kHz]	Result OK or NOK	5A	1.7	174.928	-50		1.7	174.928	0		1.7	174.928	+50		13F	1.7	239.200	-50		1.7	239.200	0		1.7	239.200	+50	
Channel	Signal BW [MHz]	Frequency [MHz]	Offset [kHz]	Result OK or NOK																																																																																					
K5	7	177.5	-50																																																																																						
	7	177.5	0																																																																																						
	7	177.5	+50																																																																																						
K12	7	226.5	-50																																																																																						
	7	226.5	0																																																																																						
	7	226.5	+50																																																																																						
K21	8	474.0	-50																																																																																						
	8	474.0	0																																																																																						
	8	474.0	+50																																																																																						
K69	8	858.0	-50																																																																																						
	8	858.0	0																																																																																						
	8	858.0	+50																																																																																						
Channel	Signal BW [MHz]	Frequency [MHz]	Offset [kHz]	Result OK or NOK																																																																																					
5A	1.7	174.928	-50																																																																																						
	1.7	174.928	0																																																																																						
	1.7	174.928	+50																																																																																						
13F	1.7	239.200	-50																																																																																						
	1.7	239.200	0																																																																																						
	1.7	239.200	+50																																																																																						
<i>Conformity</i>	<input type="checkbox"/> <b>OK</b> <input type="checkbox"/> <b>Fault</b> <input type="checkbox"/> Major <input type="checkbox"/> Minor, define fail reason in comments																																																																																								
<i>Comments</i>	If possible describe if fault can be fixed with software update: <input type="checkbox"/> <b>YES</b> <input type="checkbox"/> <b>NO</b> Describe more specific faults and/or other information																																																																																								
<i>Date</i>	<i>Sign</i>																																																																																								

<i>Test Case</i>	<b>Task 3:35 DVB-T2: Frequencies: Signal bandwidths</b>
<i>Section</i>	NorDig Unified 3.4.2.4
<i>Requirement</i>	<p>The NorDig IRD for DVB-T2 shall support both the normal and extended carrier modes.</p> <p>The NorDig IRD for DVB-T2 shall follow network parameter change from normal to extended carrier mode and vice versa automatically without any need for user action.</p>

	<p>VHF Bands: The NorDig IRD shall (1) for the supported frequency ranges be able to receive 7 MHz and should be able to receive 8 MHz DVB-T/T2 signals. If 8 MHz bandwidth is supported it shall automatically detect which DVB-T/T2 signal bandwidth is being used, and it shall be possible to receive the 8 MHz DVB-T/T2 signals on the 7 MHz channel frequency raster. If 1.7 MHz bandwidth is supported the NorDig IRD-T2 shall automatically detect which DVB-T/T2 signal bandwidth is being used.</p> <p>UHF Bands: The NorDig IRD shall for the supported frequency ranges be able to receive 8 MHz DVB-T/T2 signals.</p>
<b>IRD Profile(s)</b>	Basic, IRD, DVB-T2
<b>Test procedure</b>	<p><b>Purpose of test:</b> To verify that the receiver is able to automatically detect the transmitted signal bandwidth and do the required adaptations for QEF reception.</p> <p><b>Equipment:</b></p> <div data-bbox="405 907 1029 996" style="border: 1px solid black; padding: 5px; margin: 10px 0;"> <pre> graph LR     A[TS source] --- B[DVB-T2 exciter] --- C[DVB-T2 receiver]             </pre> </div> <p>Use following DVB-T2 modes in single PLP mode:</p> <ul style="list-style-type: none"> <li>• VHF III 1.7 MHz signal bandwidth: 8k normal bandwidth, 64QAM rotated, G1/8, PP2, R2/3, L1-ACE &amp; TR PAPR</li> <li>• VHF III 7 MHz signal bandwidth: 32k normal or extended bandwidth, 256QAM rotated, GI19/256, PP2, R2/3, L1-ACE &amp; TR PAPR</li> <li>• VHF III 8 MHz signal bandwidth: 32k extended bandwidth, 256QAM rotated, GI19/256, PP2, R3/5, L1-ACE &amp; TR PAPR</li> <li>• UHF IV/V 8 MHz signal bandwidth: 32k normal or extended bandwidth, 256QAM rotated, GI1/16, PP4, R2/3, L1-ACE &amp; TR PAPR</li> </ul> <p><b>Test procedure:</b></p> <ol style="list-style-type: none"> <li>1. Set up the test instruments.</li> <li>2. Use the transmission frequency UHF IV/V 666 MHz (K45) and an input level of -50 dBm to the receiver. Select corresponding DVB-T2 mode from list above.</li> <li>3. Connect the receiver and perform an automatic or manual channel search. The signal bandwidth initialization shall not be required by the user.</li> <li>4. Use the quality measurement procedure 1 (QMP1).</li> <li>5. Fill the result in the measurement record: <b>OK</b> or <b>NOK</b>.</li> <li>6. Change the transmission frequency to VHF III channel 198.5 MHz (K8) and signal bandwidth to 7 MHz. Select corresponding DVB-T2 mode from list above.</li> <li>7. Verify that the channel list does not have any services installed by performing initialization to factory defaults or in such way.</li> <li>8. Do an automatic or manual channel search. The signal bandwidth initialization shall not be required by the user.</li> <li>9. Use the quality measurement procedure 1 (QMP1).</li> <li>10. Fill the result in the measurement record: <b>OK</b> or <b>NOK</b>.</li> <li>11. If receiver supports 1.7MHz signal bandwidth in VHF III, change the transmission frequency to VHF III channel 209.936 MHz (10A) and signal bandwidth to 1.7 MHz. Select corresponding DVB-T2 mode from list above.</li> </ol>

12. Verify that the channel list does not have any services installed by performing initialization to factory defaults or in such way.
13. Do an automatic or manual channel search. The signal bandwidth initialization shall not be required by the user.
14. Use the quality measurement procedure 1 (QMP1).
15. If receiver supports 8MHz signal bandwidth in VHF III, change the transmission frequency to VHF III channel 198.5 MHz (K8) and signal bandwidth to 8 MHz. Select corresponding DVB-T2 mode from list above.

**Expected result:**

The test results shall be OK for all tests in the table 1 and table 2 in the measurement record and user does not have to initialize the signal bandwidth for the successful channel search and QEF reception.

If 1.7MHz signal bandwidth in VHF is supported the test result shall be OK for the test in the table 3 in the test results.

If 8MHz signal bandwidth in VHF is supported the test result shall be OK for the test in the table 3 in the test results.

**Test result(s)**

Measurement record:

Channel	Frequency [MHz]	Signal bandwidth [MHz]	Result OK or NOK
K8	198.5	7	
K45	666.0	8	

Table 1 Mandatory signal bandwidths to receive for normal carrier mode.

Channel	Frequency [MHz]	Signal bandwidth [MHz]	Result OK or NOK
K8	198.5	7	
K45	666.0	8	

Table 2 Mandatory signal bandwidths to receive for extended carrier mode

Channel	Frequency [MHz]	Signal bandwidth [MHz]	Result OK or NOK
10A	209.936	1.7	

Table 3 Optional signal bandwidth to receive for normal carrier mode.

Channel	Frequency [MHz]	Signal bandwidth [MHz]	Result OK or NOK
K8	198.5	8	

Table 4 Optional signal bandwidths to receive for extended carrier mode

**Conformity**

OK Fault  Major  Minor, define fail reason in comments

**Comments**

If possible describe if fault can be fixed with software update:  YES  NO  
Describe more specific faults and/or other information

**Date**

**Sign**

**Test Case**

**Task 3:36 DVB-T2: Modes**

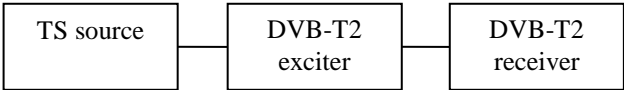
<b>Section</b>	NorDig Unified 3.4.3				
<b>Requirement</b>	<p>The NorDig IRD-T2 shall be capable of correctly demodulating all allowed configurations, or “DVB-T2 modes”, as specified in EN 302 755, with the following exceptions:</p> <ul style="list-style-type: none"> <li>• Support for 1.7 MHz bandwidth is optional</li> <li>• Support for Time Frequency Slicing (TFS) is optional.</li> <li>• Support for 10 MHz bandwidth is not required</li> <li>• Support for PLPs carrying GS/GSE is not required</li> <li>• Support for Transmission modes 16K and 32K, when 1.7 MHz RF bandwidth is supported, is not required</li> </ul> <p>The existence of transmissions using configurations that the NorDig IRD-T2 is not required to support shall not cause the NorDig IRD-T2 to malfunction.</p> <p>When TFS is supported the following shall apply: For 8MHz DVB-T2 signals with modulation parameters {32K, 256-QAM, CR=3/5, GI=1/16} on all data PLPs the NorDig IRD-T2 shall support reception of variable-bit rate PLPs in TFS with a TS peak data rate of up to 15 Mbps using up to six RF frequencies. Each TS is split into one data PLP and a common PLP.</p> <p>The NorDig IRD shall automatically detect which mode is being used.</p>				
<b>IRD Profile(s)</b>	Basic, IRD, DVB-T2				
<b>Test procedure</b>	<p><b>Purpose of test:</b> To verify the reception of subset of all possible DVB-T2 modes.</p> <p>TFS support is not tested.</p> <p>MISO support is not tested.</p> <p>FEC frame length 16200 is not tested.</p> <p>Input Mode B is not tested.</p> <p>Normal mode (NM) is not tested.</p> <p>Extended and normal carrier modes are tested in test Task 3:36 DVB-T2 Frequencies: Bandwidth</p> <p><b>Equipment:</b></p> <div style="text-align: center;">  <pre> graph LR     A[TS source] --- B[DVB-T2 exciter]     B --- C[DVB-T2 receiver]             </pre> </div> <p>Use Mode A (Single PLP) and following deviations to parameter settings defined in 2.3.7 Summary of DVB-T2 modes in DVB-T2 test tasks:</p> <table border="1" data-bbox="464 1765 1118 1839"> <tr> <td>Carrier mode</td> <td>Normal</td> </tr> <tr> <td>Signal bandwidth</td> <td>8MHz</td> </tr> </table> <p><b>Test procedure:</b></p> <ol style="list-style-type: none"> <li>1. Set up the test instruments.</li> <li>2. Use channel K45 (666MHz) and an input level of -50 dBm.</li> </ol>	Carrier mode	Normal	Signal bandwidth	8MHz
Carrier mode	Normal				
Signal bandwidth	8MHz				

3. Test all the DVB-T2 parameter combinations listed in tables in test results using the quality measurement procedure 1 (QMP1).
4. Fill the result in the measurement record: **OK** or **NOK**.

**Expected result:**

The test shall be OK for all tested DVB-T2 mode parameter listed in test result tables.

**Test result(s)**

Measurement record:

	FFT	NOK or OK
64QAM rotated, GI1/8, PP2, R2/3, L1-ACE & TR PAPR, $L_f=90$	1k	
64QAM rotated, GI1/8, PP2, R2/3, L1-ACE & TR PAPR, $L_f=90$	2k	
64QAM rotated, GI1/8, PP2, R2/3, L1-ACE & TR PAPR, $L_f=90$	4k	
64QAM rotated, GI1/8, PP2, R2/3, L1-ACE & TR PAPR, $L_f=90$	8k	
64QAM rotated, GI1/8, PP2, R2/3, L1-ACE & TR PAPR, $L_f=90$	8k ext	
256QAM rotated, GI1/8, PP2, R2/3, L1-ACE & TR PAPR, $L_f=90$	16k	
256QAM rotated, GI1/8, PP2, R2/3, L1-ACE & TR PAPR, $L_f=90$	16k ext	
256QAM rotated, GI1/8, PP2, R3/4, L1-ACE & TR PAPR, $L_f=60$	32k	
256QAM rotated, GI1/8, PP2, R3/4, L1-ACE & TR PAPR, $L_f=60$	32k ext	

Table 1 FFT sizes

	Rotation	NOK or OK
32k, 256QAM GI1/16, PP4, R2/3, L1-ACE & TR PAPR, $L_f=62$	Rotated	
	Non-rotated	

Table 2 Constellation rotation

	Pilot pattern	NOK or OK
16k,256QAM rotated,GI1/4,R2/3,L1-ACE & TR PAPR, $L_f=90$	PP1	
32k,256QAM rotated,GI1/8,R3/4,L1-ACE & TR PAPR, $L_f=60$	PP2	
16k,256QAM rotated,GI1/8,R2/3,L1-ACE & TR PAPR, $L_f=90$	PP3	
32k,256QAM rotated,GI1/16,R2/3,L1-ACE & TR PAPR, $L_f=62$	PP4	
16k,256QAM rotated,G1/16,R2/3,L1-ACE & TR PAPR, $L_f=90$	PP5	
32k,256QAM rotated,GI1/32,R3/5,L1-ACE & TR PAPR, $L_f=62$	PP6	
32k,256QAM rotated,GI1/128,R2/3,L1-ACE & TR PAPR, $L_f=60$	PP7	
32k,256QAM rotated,GI1/16,R3/4,L1-ACE & TR PAPR, $L_f=62$	PP8	



Table 3 Pilot patterns

		<b>NOK or OK</b>						
		L1-ACE & TR PAPR, rotated constellation						
		32K, PP7, L <sub>f</sub> = 60	32K, PP4, L <sub>f</sub> = 60	32K, PP2, L <sub>f</sub> = 60	32K, PP2, L <sub>f</sub> = 60	32K, PP2, L <sub>f</sub> = 60	32K, PP2, L <sub>f</sub> = 60	8K, PP1 L <sub>f</sub> = 60
Modulation	FEC	1/128	1/32	1/16	19/256	1/8	19/128	1/4
QPSK	1/2							
QPSK	3/5							
QPSK	2/3							
QPSK	3/4							
QPSK	4/5							
QPSK	5/6							
16-QAM	1/2							
16-QAM	3/5							
16-QAM	2/3							
16-QAM	3/4							
16-QAM	4/5							
16-QAM	5/6							
64-QAM	1/2							
64-QAM	3/5							
64-QAM	2/3							
64-QAM	3/4							
64-QAM	4/5							
64-QAM	5/6							
256-QAM	1/2							
256-QAM	3/5							
256-QAM	2/3							
256-QAM	3/4							
256-QAM	4/5							
256-QAM	5/6							

Table 4 Guard intervals, constellations and code rates for allowed combinations of FFT sizes, pilot patterns and L1-ACE & TR PAPR.

	<b>PAPR</b>	<b>L1_ACE_MAX</b>	<b>NOK or OK</b>
32k normal, 256QAM non-rotated GI1/8, PP2, R3/4	L1-ACE and P2-TR	0	
	L1-ACE and ACE only	0	
	L1-ACE and TR only	0	
	L1-ACE, ACE and TR	0	
	Not used	N/A	

Table 5 Peak-to-average power ratio (PAPR)

<b>Conformity</b>	<input type="checkbox"/> <b>OK Fault</b> <input type="checkbox"/> Major <input type="checkbox"/> Minor, define fail reason in comments
<b>Comments</b>	If possible describe if fault can be fixed with software update: <input type="checkbox"/> <b>YES</b> <input type="checkbox"/> <b>NO</b> Describe more specific faults and/or other information
<b>Date</b>	<b>Sign</b>

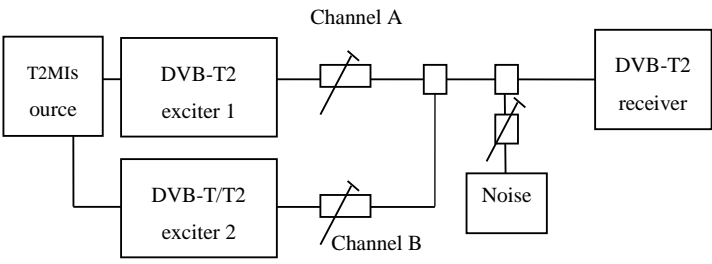
<b>Test Case</b>	<b>Task 3:37 DVB-T2: MISO</b>		
<b>Section</b>	NorDig Unified 3.4.3		
<b>Requirement</b>	<p>Within the NorDig IRD specification the concept of “DVB-T2 mode” includes e.g. (the list is not exhaustive):</p> <ul style="list-style-type: none"> <li>• SISO/MISO</li> </ul>		
<b>IRD Profile(s)</b>	Basic, IRD, DVB-T2		
<b>Test procedure</b>	<p><b>Purpose of test:</b> To verify that the receiver fully supports the expected advantages of MISO transmissions modes in SFN.</p> <p><b>Equipment:</b></p>  <p>T2MI source shall have a TS containing at least one service.</p> <p>Use Mode A (Single PLP) and following deviations to parameter settings defined in 2.3.7 Summary of DVB-T2 modes in DVB-T2 test tasks:</p> <table border="1" data-bbox="464 1151 1267 1189"> <tr> <td>SISO/MISO</td> <td>MISO</td> </tr> </table> <p>Both DVB-T2 exciters must be locked to same reference signals as well as run in the SFN mode.</p> <p><b>Test procedure:</b></p> <p>First verify reception in Gaussian like channel when exciters are in MISO modes with different group settings.</p> <ol style="list-style-type: none"> <li>1. Set up the test instruments</li> <li>2. Set the channel A to 666.0MHz (K45).</li> <li>3. Set the channel B to 666.0MHz (K45).</li> <li>4. Set the DVB-T2 exciter in channel A to MISO group 1 mode with parameters 8 MHz signal bandwidth, 32k extended, 256QAM rotated, GI1/16, PP2, R2/3, L1-ACE &amp; TR PAPR, <math>L_r=62</math>.</li> <li>5. Set the DVB-T2 exciter in channel B to MISO group 2 mode with parameters 8MHz signal bandwidth, 32k extended, 256QAM rotated, GI1/16, PP2, R2/3, L1-ACE &amp; TR PAPR, <math>L_r=62</math>.</li> <li>6. Set the receiver input level for the DVB-T2 signal in channel A to -50 dBm. Attenuate the input signal from channel B so that it is not able to be received.</li> <li>7. Adjust the noise power to a level corresponding 30dB signal-to-noise ratio.</li> <li>8. Verify the service carried on channel A is able to be received and decoded correctly using quality measurement procedure 1(QMP1).</li> <li>9. Fill in <b>NOK</b> or <b>OK</b> in measurement record.</li> <li>10. Increase the attenuation for the channel A so that it is not any more able to be received.</li> <li>11. Decrease the attenuation for the channel B. Adjust the receiver input level to -50dBm.</li> </ol>	SISO/MISO	MISO
SISO/MISO	MISO		

12. Verify the service carried on channel Bis able to be received and decoded correctly using quality measurement procedure 1 (QMP1).
13. Fill in **NOK** or **OK** in measurement record.

Secondly verify reception in SFN like channels in MISO modes with different group settings.

14. Set the DVB-T2 exciter in channel A to MISO group 1 mode with parameters 8 MHz signal bandwidth, 32k extended, 256QAM rotated, GI1/16, PP2, R2/3, L1-ACE & TR PAPR,  $L_r=62$ .
15. Set relative delay of the exciters to 10 $\mu$ s, adjust output levels to 0dB echo difference and verify the total output power level is -50dBm as well as noise power to a level corresponding 30dB signal-to-noise ratio.
16. Verify the service carried on channel A is able to be received and decoded correctly using quality measurement procedure 1 (QMP1).
17. Fill in **NOK** or **OK** in measurement record.
18. Set the relativedelay of the exciters to 170 $\mu$ s and output power level difference to 0dB.
19. Verify the service carried on channel A is able to be received and decoded correctly using quality measurement procedure 1 (QMP1).
20. Fill in **NOK** or **OK** in measurement record.

Thirdly verify reception in SFN like channels in MISO modes with equal group settings.

21. Set the DVB-T2 exciters in channel A and B to MISO group 2 <sup>1)</sup> mode with parameters 8 MHz signal bandwidth, 32k extended, 256QAM rotated, GI1/16, PP2, R2/3, L1-ACE & TR PAPR,  $L_r=62$ .
22. Set relative delay of the exciters to 10 $\mu$ s, adjust output levels to 0dB echo difference and verify the total output power level is -50dBm as well as noise power to a level corresponding 30dB signal-to-noise ratio.
23. Verify the service carried on is able to be received and decoded correctly using quality measurement procedure 1 (QMP1).
24. Fill in **NOK** or **OK** in measurement record.
25. Set the relative delay of the exciters to 170 $\mu$ s and output power level difference to 0dB.
26. Verify the service carried on is able to be received and decoded correctly using quality measurement procedure 1 (QMP1).
27. Fill in **NOK** or **OK** in measurement record.

<sup>1)</sup>Consider reception in SFN consisting three or more transmitters. Because of group settings in exciters, reception from exciters within same group or different groups may occur.

**Expected result:**

The IRD is able to decode services correctly and all the test results are OK.

**Test result(s)**

Measurement record

Exciter 1	Exciter 2	Channel profile	NOK or OK
MISO group 1	-	Gaussian	
-	MISO group 2	Gaussian	
MISO group 1	MISO group 2	10 $\mu$ s 0dB echo	
MISO group 1	MISO group 2	170 $\mu$ s 0dB echo	
MISO group 2	MISO group 2	10 $\mu$ s 0dB echo	
MISO group 2	MISO group 2	170 $\mu$ s 0dB echo	

<b>Conformity</b>	<input type="checkbox"/> <b>OK Fault</b> <input type="checkbox"/> Major <input type="checkbox"/> Minor, define fail reason in comments	
<b>Comments</b>	If possible describe if fault can be fixed with software update: <input type="checkbox"/> <b>YES</b> <input type="checkbox"/> <b>NO</b> Describe more specific faults and/or other information	
<b>Date</b>		<b>Sign</b>

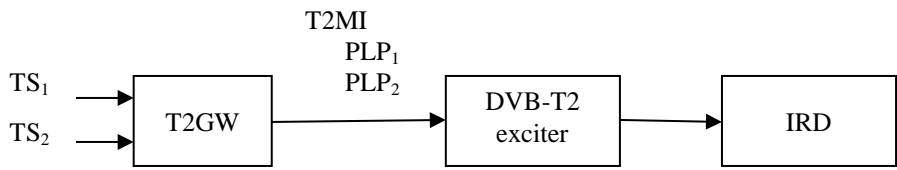
<b>Test Case</b>	<b>Task 3:38 DVB-T2: Input Mode B (multiple PLPs)</b>	
<b>Section</b>	NorDig Unified 3.4.3	
<b>Requirement</b>	Within the NorDig IRD specification the concept of “DVB-T2 mode” includes e.g. (the list is not exhaustive): <ul style="list-style-type: none"> <li>• Input Mode A (single PLP) or Input Mode B (Multiple PLPs – Common PLP, Type 1 and 2 up to the maximum allowed figure 255)</li> </ul>	
<b>IRD Profile(s)</b>	Basic, IRD, DVB-T2	
<b>Test procedure</b>	<p><b>Purpose of test:</b> To verify that receiver supports input mode B with multiple PLPs without common PLP.</p> <p><b>Equipment:</b></p>  <pre> graph LR     TS1 --&gt; T2GW     TS2 --&gt; T2GW     T2GW -- "T2MI PLP1 PLP2" --&gt; Exciter[DVB-T2 exciter]     Exciter --&gt; IRD   </pre> <p>Use Mode B (Multiple PLP) parameter settings defined in 2.3.7 Summary of DVB-T2 modes in DVB-T2 test tasks.</p> <p>The DVB-T2 exciter is configured with parameters 8 MHz signal bandwidth, 32k extended, 256QAM rotated, GI1/16, PP4, R2/3, L1-ACE &amp; TR PAPR, <math>L_f=62</math>.</p> <p>In figure above a T2GW is producing the T2MI signal with multiple PLPs. Another equipment can be used as well supporting multiple PLPs.</p> <p>TS<sub>1</sub> is broadcasted as PLP<sub>1</sub>. TS<sub>2</sub> is broadcasted as PLP<sub>2</sub>.</p> <p>Both TSs carry services able to be decoded in IRD.</p> <p><b>Test procedure:</b></p> <ol style="list-style-type: none"> <li>1. Configure the system</li> <li>2. Make automatic channel search in the IRD</li> <li>3. Verify the service carried with TSs are decoded in the IRD</li> </ol> <p><b>Expected result:</b></p> <p>IRD is able to decode services carried within TS<sub>1</sub> and TS<sub>2</sub> correctly.</p>	
<b>Test result(s)</b>		
<b>Conformity</b>	<input type="checkbox"/> <b>OK Fault</b> <input type="checkbox"/> Major <input type="checkbox"/> Minor, define fail reason in comments	

<b>Comments</b>	If possible describe if fault can be fixed with software update: <input type="checkbox"/> YES <input type="checkbox"/> NO Describe more specific faults and/or other information		
<b>Date</b>		<b>Sign</b>	

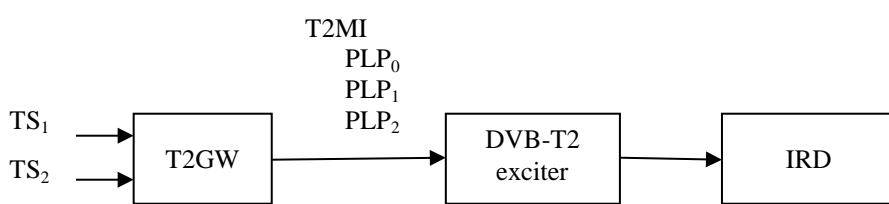
<b>Test Case</b>	<b>Task 3:39 DVB-T2: Input Mode B (multiple PLPs and common PLP)</b>
<b>Section</b>	NorDig Unified 3.4.3
<b>Requirement</b>	Within the NorDig IRD specification the concept of “DVB-T2 mode” includes e.g. (the list is not exhaustive): Input Mode A (single PLP) or Input Mode B (Multiple PLPs – Common PLP, Type 1 and 2 up to the maximum allowed figure 255)
<b>IRD Profile(s)</b>	Basic, IRD, DVB-T2
<b>Test procedure</b>	<p><b>Purpose of test:</b> To verify that receiver supports input mode B with multiple PLPs and common PLP.</p> <p><b>Equipment:</b></p>  <pre> graph LR     TS1 --&gt; T2GW     TS2 --&gt; T2GW     T2GW -- "T2MI PLP0 PLP1 PLP2" --&gt; Exciter[DVB-T2 exciter]     Exciter --&gt; IRD   </pre> <p>Use Mode B (Multiple PLP) parameter settings defined in 2.3.7 Summary of DVB-T2 modes in DVB-T2 test tasks.</p> <p>The DVB-T2 exciter is configured with parameters 8 MHz signal bandwidth, 32k extended, 256QAM rotated, GI1/16, PP4, R2/3, L1-ACE &amp; TR PAPR, <math>L_f=62</math>.</p> <p>In figure above a T2GW is producing the T2MI signal with multiple PLPs. Another equipment can be used as well supporting multiple PLPs.</p> <p>The PLP<sub>0</sub> corresponds common PLP and carries information equipment supports. In this test the common information is EIT which content can be verified in IRD.</p> <p>PLP<sub>0</sub> carries the PSI/SI TS<sub>1</sub> is broadcasted as PLP<sub>1</sub>. TS<sub>2</sub> is broadcasted as PLP<sub>2</sub>.</p> <p>Both TSs carries services and EIT able to be decoded in IRD.</p> <p><b>Test procedure:</b></p> <ol style="list-style-type: none"> <li>1. Configure the system</li> <li>2. Make automatic channel search in the IRD</li> <li>3. Verify the service carried with TSs are decoded in the IRD</li> </ol> <p><b>Expected result:</b> IRD is able to decode services carried within TS<sub>1</sub> and TS<sub>2</sub> correctly and present EIT information correctly.</p>



<b>Test result(s)</b>	
<b>Conformity</b>	<input type="checkbox"/> OK Fault <input type="checkbox"/> Major <input type="checkbox"/> Minor, define fail reason in comments
<b>Comments</b>	If possible describe if fault can be fixed with software update: <input type="checkbox"/> YES <input type="checkbox"/> NO Describe more specific faults and/or other information
<b>Date</b>	<b>Sign</b>

<b>Test Case</b>	<b>Task 3:40 DVB-T2: Input Mode B (RBM for TDI)</b>						
<b>Section</b>	NorDig Unified 3.4.3						
<b>Requirement</b>	<p>Within the NorDig IRD specification the concept of “DVB-T2 mode” includes e.g. (the list is not exhaustive):</p> <ul style="list-style-type: none"> <li>Input Mode A (single PLP) or Input Mode B (Multiple PLPs – Common PLP, Type 1 and 2 up to the maximum allowed figure 255)</li> </ul> <p>DVB-T2 signal introduces a receiver buffer model (RBM) which is fundamental when it comes to receive signals where carried transport stream doesn't have constant bit rate as it is case for MPLPs.</p>						
<b>IRD Profile(s)</b>	Basic, IRD, DVB-T2						
<b>Test procedure</b>	<p><b>Purpose of test:</b> To verify that received DVB-T2 signal can stress the receiver RBM regarding time deinterleaver buffer based on DVB V&amp;V tests.</p> <p><b>Equipment:</b></p> <pre> graph LR     TS[TS Source] --&gt; Mod[DVB-T2 modulator]     Mod --&gt; Fading[Fading simulator]     Fading --&gt; Noise[Noise generator]     Noise --&gt; Up[Up converter]     Up --&gt; Circ((+))     Circ --&gt; PM[Power meter]     Circ --&gt; Rec[DVB-T2 receiver]     Rec --&gt; Mon[Monitor]     </pre> <p>Use Mode B (multiple PLP) and parameter settings defined in 2.3.7 Summary of DVB-T2 modes for NU_M2.</p> <p>T2 frames within <math>PLP_{id}=0</math> and 1 shall carry a valid TS. TS bit rate is restricted to maximum of 3.3 MBit/s.</p> <p>The content within TS is maximized to bit rate the TS can carry, with other words, minimize the NULL packets in TS.</p> <p>TS contains one service.</p> <p>The DVB-T2 signal generation shall support DVB V&amp;V dynamic multiple PLP models. The configuration files are available for download on NorDig homepages.</p> <table border="1"> <thead> <tr> <th>Parameter</th> <th>Description</th> <th>Value</th> </tr> </thead> <tbody> <tr> <td>M</td> <td>Interval in packets between common PLP</td> <td>22</td> </tr> </tbody> </table>	Parameter	Description	Value	M	Interval in packets between common PLP	22
Parameter	Description	Value					
M	Interval in packets between common PLP	22					

	slots	
L	Number of separate chapters	4
NumReps	Repeats of repeating unit	15, 1, 15, 1
RunLength (TS0)	Run length for TS0 in each repeating unit in a chapter	92, 20, 44, 27
RunLength (TS1)	Run length for TS1 in each repeating unit in a chapter	44, 27, 92, 20
RunLength (TS2)	Run length for TS2 in each repeating unit in a chapter	8, 2, 8, 2
RunLength (TS3)	Run length for TS3 in each repeating unit in a chapter	8, 2, 8, 2
<b>Test procedure:</b>		
<ol style="list-style-type: none"> <li>1. Set up the test instruments.</li> <li>2. Use the following DVB-T2 mode {32K extended, 256QAM, PP7, <math>\Delta/T_U=1/128</math>} and signal bandwidth 8MHz in exciter.</li> <li>3. Use Gaussian channel without additional noise or interference.</li> <li>4. Set the receiver input level to -50 dBm.</li> <li>5. Verify valid TS is mapped into the <math>PLP_{id}=0</math>.</li> <li>6. Perform channel search and make sure the receiver has deleted any possible old service on the channel list.</li> <li>7. Verify the received signal carrying service using quality measurement procedure 2 (QMP2).</li> <li>8. Repeat the test for a valid TS mapped into the <math>PLP_{id}=1</math>.</li> </ol>		
<b>Expected result:</b>		
Broadcasting of DVB-T2 signal according to signal description which stresses the RBM is demodulated correctly and service carried within TS is decoded error free.		
<b>Test result(s)</b>		
<b>Conformity</b>	<input type="checkbox"/> OK <input type="checkbox"/> Fault <input type="checkbox"/> Major <input type="checkbox"/> Minor, define fail reason in comments	
<b>Comments</b>	If possible describe if fault can be fixed with software update: <input type="checkbox"/> YES <input type="checkbox"/> NO Describe more specific faults and/or other information	
<b>Date</b>		<b>Sign</b>

<b>Test Case</b>	<b>Task 3:41 DVB-T2: Input Mode B (RBM for DJB)</b>
<b>Section</b>	NorDig Unified 3.4.3
<b>Requirement</b>	<p>Within the NorDig IRD specification the concept of "DVB-T2 mode" includes e.g. (the list is not exhaustive):</p> <ul style="list-style-type: none"> <li>• Input Mode A (single PLP) or Input Mode B (Multiple PLPs – Common PLP, Type 1 and 2 up to the maximum allowed figure 255)</li> </ul> <p>DVB-T2 signal introduces a receiver buffer model (RBM) which is fundamental when it comes to receive signals where carried transport stream doesn't have constant bit rate as it is case for MPLPs.</p>
<b>IRD Profile(s)</b>	Basic, IRD, DVB-T2
<b>Test procedure</b>	<p><b>Purpose of test:</b> To verify that received DVB-T2 signal can stress the receiver RBM regarding de-jitter</p>

buffer based on DVB V&V tests.

**Equipment:**

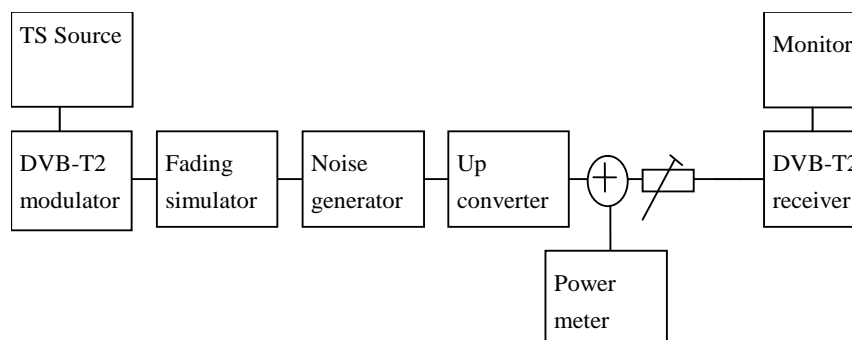

Use Mode B (multiple PLP) and parameter settings defined in 2.3.7 Summary of DVB-T2 modes for NU\_M3.

T2 frames within  $PLP_{id}=0$  and 2 shall carry a valid TS. TS bit rate is restricted to maximum of 3.3 MBit/s.

The content within TS is maximized to bit rate the TS can carry, with other words, minimize the NULL packets in TS.

TS contains one service.

The DVB-T2 signal generation shall support DVB V&V dynamic multiple PLP models. The configuration files are available for download on NorDig homepages.

Parameter	Description	Value
M	Interval in packets between common PLP slots	11
L	Number of separate chapters	8
NumReps	Repeats of repeating unit	15, 1, 15, 1, 15, 1, 15, 1, 15, 1
RunLength (TS0)	Run length for TS0 in each repeating unit in a chapter	102, 95, 102, 95, 102, 95, 102, 95
RunLength (TS1)	Run length for TS1 in each repeating unit in a chapter	15, 29, 15, 29, 15, 29, 15, 29
RunLength (TS2)	Run length for TS2 in each repeating unit in a chapter	14, 15, 14, 15, 14, 15, 14, 15
RunLength (TS3)	Run length for TS3 in each repeating unit in a chapter	14, 16, 14, 16, 14, 16, 14, 16

**Test procedure:**

1. Set up the test instruments.
2. Use the following DVB-T2 mode {32K extended, 256QAM, PP7,  $\Delta/T_U=1/128$ } and signal bandwidth 8MHz in exciter.
3. Use Gaussian channel without additional noise or interference.
4. Set the receiver input level to -50 dBm.
5. Verify valid TS is mapped into the  $PLP_{id}=0$ .
6. Perform channel search and make sure the receiver has deleted any possible old service on the channel list.
7. Verify the received signal carrying service using quality measurement procedure 2

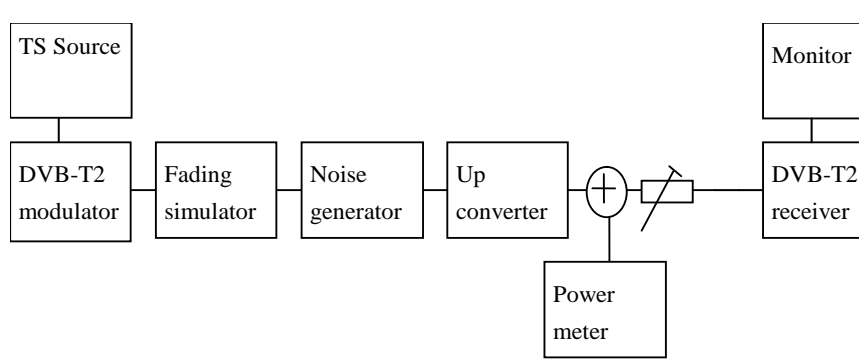

	(QMP2). 8. Repeat the test for TS mapped into the $PLP_{id=2}$ .  <b>Expected result:</b>  Broadcasting of DVB-T2 signal according to signal description which stresses the RBM is demodulated correctly and service carried within TS is decoded error free.
<b>Test result(s)</b>	
<b>Conformity</b>	<input type="checkbox"/> <b>OK Fault</b> <input type="checkbox"/> Major <input type="checkbox"/> Minor, define fail reason in comments
<b>Comments</b>	If possible describe if fault can be fixed with software update: <input type="checkbox"/> <b>YES</b> <input type="checkbox"/> <b>NO</b> Describe more specific faults and/or other information
<b>Date</b>	<b>Sign</b>

<b>Test Case</b>	<b>Task 3:42 DVB-T2: Input Mode B (RBM when FEF present)</b>
<b>Section</b>	NorDig Unified 3.4.3
<b>Requirement</b>	<p>Within the NorDig IRD specification the concept of “DVB-T2 mode” includes e.g. (the list is not exhaustive):</p> <ul style="list-style-type: none"> <li>• Input Mode A (single PLP) or Input Mode B (Multiple PLPs – Common PLP, Type 1 and 2 up to the maximum allowed figure 255)</li> </ul> <p>DVB-T2 signal introduces a receiver buffer model (RBM) which is fundamental when it comes to receive signals where carried transport stream doesn’t have constant bit rate as it is case for MPLPs and FEF.</p>
<b>IRD Profile(s)</b>	Basic, IRD, DVB-T2
<b>Test procedure</b>	<p><b>Purpose of test:</b> To verify that received DVB-T2 signal can stress the receiver RBM regarding time deinterleaver buffer based on DVB V&amp;V tests.</p> <p><b>Equipment:</b></p>  <pre> graph LR     TS_Src[TS Source] --&gt; Mod[DVB-T2 modulator]     Mod --&gt; Fading[Fading simulator]     Fading --&gt; Noise[Noise generator]     Noise --&gt; Up[Up converter]     Up --&gt; Circ((⊕))     Circ --&gt; PM[Power meter]     Circ --&gt; Recv[DVB-T2 receiver]     Recv --&gt; Monitor[Monitor]   </pre> <p>Use Mode B (multiple PLP) and parameter settings defined in 2.3.7 Summary of DVB-T2 modes for NU_M4.</p> <p>The DVB-T2 signal shall contain a FEF with PRBS content and with a FEF interval of 4 T2 frames.</p> <p>The size of the PRBS FEF is 380000 samples and T2 frame size <math>L_f=28</math> symbols.</p>

	<p>T2 frames within <math>PLP_{id}=0</math> and 3 shall carry a valid TS. TS bit rate is restricted to maximum of 3.3MBit/s.</p> <p>The content within TS is maximized to bit rate the TS can carry, with other words, minimize the NULL packets in TS.</p> <p>TS contains one service.</p> <p>The DVB-T2 signal generation shall support DVB V&amp;V dynamic multiple PLP models. The configuration files are available for download on NorDig homepages.</p> <table border="1"> <thead> <tr> <th>Parameter</th> <th>Description</th> <th>Value</th> </tr> </thead> <tbody> <tr> <td>M</td> <td>Interval in packets between common PLP slots</td> <td>11</td> </tr> <tr> <td>L</td> <td>Number of separate chapters</td> <td>10</td> </tr> <tr> <td>NumReps</td> <td>Repeats of repeating unit</td> <td>15, 1, 15, 1, 15, 1, 15, 1, 15, 1</td> </tr> <tr> <td>RunLength (TS0)</td> <td>Run length for TS0 in each repeating unit in a chapter</td> <td>102, 95, 102, 95, 0, 0, 66, 3, 102, 95</td> </tr> <tr> <td>RunLength (TS1)</td> <td>Run length for TS1 in each repeating unit in a chapter</td> <td>13, 11, 13, 11, 19, 13, 8, 17, 13, 11</td> </tr> <tr> <td>RunLength (TS2)</td> <td>Run length for TS2 in each repeating unit in a chapter</td> <td>13, 15, 13, 15, 19, 13, 8, 15, 13, 15</td> </tr> <tr> <td>RunLength (TS3)</td> <td>Run length for TS3 in each repeating unit in a chapter</td> <td>13, 14, 13, 14, 18, 11, 7, 3, 13, 14</td> </tr> </tbody> </table> <p><b>Test procedure:</b></p> <ol style="list-style-type: none"> <li>1. Set up the test instruments.</li> <li>2. Use the following DVB-T2 mode {32K extended, 256QAM, PP7, <math>\Delta/T_U=1/128</math>} and signal bandwidth 8MHz in exciter.</li> <li>3. Use Gaussian channel without additional noise or interference.</li> <li>4. Set the receiver input level to -50 dBm.</li> <li>5. Verify valid TS is mapped into the <math>PLP_{id}=0</math>.</li> <li>6. Perform channel search and make sure the receiver has deleted any possible old service on the channel list.</li> <li>7. Verify the received signal carrying service using quality measurement procedure 2 (QMP2).</li> <li>8. Repeat the test for a valid TS mapped into the <math>PLP_{id}=3</math>.</li> </ol> <p><b>Expected result:</b></p> <p>Broadcasting of DVB-T2 signal according to signal description which stresses the RBM is demodulated correctly and service carried within TS is decoded error free.</p>	Parameter	Description	Value	M	Interval in packets between common PLP slots	11	L	Number of separate chapters	10	NumReps	Repeats of repeating unit	15, 1, 15, 1, 15, 1, 15, 1, 15, 1	RunLength (TS0)	Run length for TS0 in each repeating unit in a chapter	102, 95, 102, 95, 0, 0, 66, 3, 102, 95	RunLength (TS1)	Run length for TS1 in each repeating unit in a chapter	13, 11, 13, 11, 19, 13, 8, 17, 13, 11	RunLength (TS2)	Run length for TS2 in each repeating unit in a chapter	13, 15, 13, 15, 19, 13, 8, 15, 13, 15	RunLength (TS3)	Run length for TS3 in each repeating unit in a chapter	13, 14, 13, 14, 18, 11, 7, 3, 13, 14
Parameter	Description	Value																							
M	Interval in packets between common PLP slots	11																							
L	Number of separate chapters	10																							
NumReps	Repeats of repeating unit	15, 1, 15, 1, 15, 1, 15, 1, 15, 1																							
RunLength (TS0)	Run length for TS0 in each repeating unit in a chapter	102, 95, 102, 95, 0, 0, 66, 3, 102, 95																							
RunLength (TS1)	Run length for TS1 in each repeating unit in a chapter	13, 11, 13, 11, 19, 13, 8, 17, 13, 11																							
RunLength (TS2)	Run length for TS2 in each repeating unit in a chapter	13, 15, 13, 15, 19, 13, 8, 15, 13, 15																							
RunLength (TS3)	Run length for TS3 in each repeating unit in a chapter	13, 14, 13, 14, 18, 11, 7, 3, 13, 14																							
<b>Test result(s)</b>																									
<b>Conformity</b>	<input type="checkbox"/> OK Fault <input type="checkbox"/> Major <input type="checkbox"/> Minor, define fail reason in comments																								
<b>Comments</b>	<p>If possible describe if fault can be fixed with software update: <input type="checkbox"/> YES <input type="checkbox"/> NO</p> <p>Describe more specific faults and/or other information</p>																								

<i>Date</i>	<i>Sign</i>
-------------	-------------

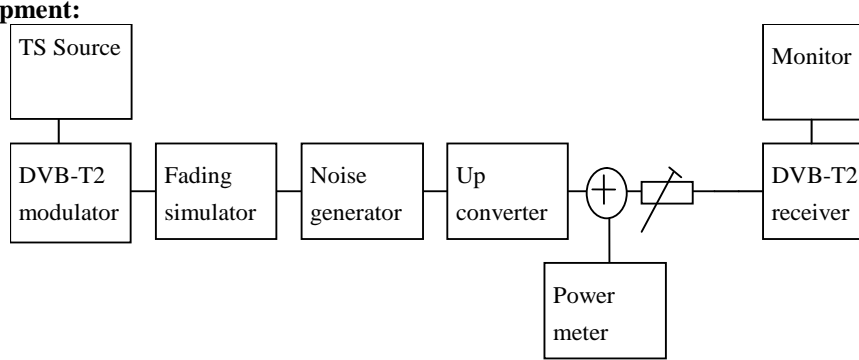
<i>Test Case</i>	<b>Task 3:43 DVB-T2: Normal mode (NM)</b>				
<i>Section</i>	NorDig Unified 3.4.3				
<i>Requirement</i>					
<i>IRD Profile(s)</i>	Basic, IRD, DVB-T2				
<i>Test procedure</i>	<p><b>Purpose of test:</b> To verify that receiver supports normal mode (NM).</p> <p><b>Equipment:</b></p>  <p>Use Mode A (Single PLP) and following deviations to parameter settings defined in 2.3.7 Summary of DVB-T2 modes in DVB-T2 test tasks:</p> <table border="1" data-bbox="446 1164 1260 1321"> <thead> <tr> <th>Mode</th> <th>NM (normal mode)</th> </tr> </thead> <tbody> <tr> <td>ISSY</td> <td>Short</td> </tr> </tbody> </table> <p>The DVB-T2 modulator is configured with parameters 8 MHz signal bandwidth, 32k extended, 256QAM rotated, GI1/16, PP4, R2/3, L1-ACE &amp; TR PAPR, <math>L_f=62</math>.</p> <p><b>Test procedure:</b></p> <ol style="list-style-type: none"> <li>1. Configure the system</li> <li>2. Make automatic channel search in the IRD</li> <li>3. Verify the services carried with TS are decoded correctly in the IRD</li> </ol> <p><b>Expected result:</b> IRD is able to decode services carried within TS correctly.</p>	Mode	NM (normal mode)	ISSY	Short
Mode	NM (normal mode)				
ISSY	Short				
<i>Test result(s)</i>					
<i>Conformity</i>	<input type="checkbox"/> OK <input type="checkbox"/> Fault <input type="checkbox"/> Major <input type="checkbox"/> Minor, define fail reason in comments				
<i>Comments</i>	If possible describe if fault can be fixed with software update: <input type="checkbox"/> YES <input type="checkbox"/> NO Describe more specific faults and/or other information				
<i>Date</i>	<i>Sign</i>				

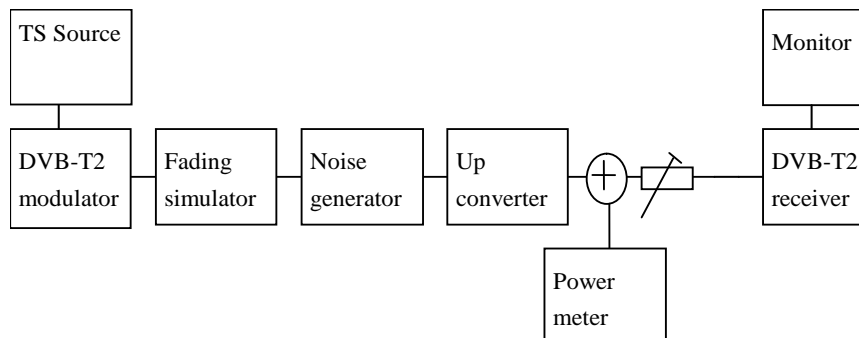
<b>Test Case</b>	<b>Task 3:44 DVB-T2: Input Mode A (zero power FEF present)</b>																		
<b>Section</b>	NorDig Unified 3.4.3																		
<b>Requirement</b>																			
<b>IRD Profile(s)</b>	Basic, IRD, DVB-T2																		
<b>Test procedure</b>	<p><b>Purpose of test:</b> To verify that broadcasting of FEF doesn't cause any harm for the receiver.</p> <p><b>Equipment:</b></p>  <p>Use Mode A (Single PLP) and following deviations to parameter settings defined in 2.3.7 Summary of DVB-T2 modes in DVB-T2 test tasks:</p> <table border="1" data-bbox="459 1052 1268 1384"> <tr> <td>ISSY</td> <td>Enabled</td> </tr> <tr> <td>FEF</td> <td>Yes</td> </tr> <tr> <td>Auxiliary streams</td> <td>Not used</td> </tr> <tr> <td>Frames per superframe (<math>N_{T2}</math>)</td> <td>6</td> </tr> <tr> <td>FEF P1: S1 Value</td> <td>2</td> </tr> <tr> <td>FEF P1: S2 Value</td> <td>1</td> </tr> <tr> <td>T2 P1:S2 Value</td> <td>1</td> </tr> <tr> <td>FEF size</td> <td>520000 samples</td> </tr> <tr> <td>Design delay</td> <td>719248 samples</td> </tr> </table> <p>The DVB-T2 signal shall contain empty FEF with a FEF interval of 6 T2 frames.</p> <p>The size of the empty FEF is 520000 samples (56.875ms) and T2 frame size <math>L_f=62</math> symbols (236.320ms). By empty FEF means FEF without content resulting to a lower RF output power during the FEF compared to T2 frame.</p> <p>T2 frames shall carry a TS. TS bitrate is maximized to the capacity the T2 frame size can deliver, with other words, the number of T2 dummy cells are minimized.</p> <p>The content within TS is maximized to bit rate the TS can carry, with other words, minimize the NULL packets in TS.</p> <p>TS contains at least one service.</p> <p>Using DVB-T2 mode specified (<math>L_f=62</math> symbols) below allows total bit rate of 36.55190642Mbit/s. Using FEF and T2 frame size relation above, the TS bit rate is 35.14229377 Mbit/s.</p> <p><b>Test procedure:</b></p>	ISSY	Enabled	FEF	Yes	Auxiliary streams	Not used	Frames per superframe ( $N_{T2}$ )	6	FEF P1: S1 Value	2	FEF P1: S2 Value	1	T2 P1:S2 Value	1	FEF size	520000 samples	Design delay	719248 samples
ISSY	Enabled																		
FEF	Yes																		
Auxiliary streams	Not used																		
Frames per superframe ( $N_{T2}$ )	6																		
FEF P1: S1 Value	2																		
FEF P1: S2 Value	1																		
T2 P1:S2 Value	1																		
FEF size	520000 samples																		
Design delay	719248 samples																		

	<ol style="list-style-type: none"> <li>1. Set up the test instruments.</li> <li>2. Use the following DVB-T2 mode {32K extended, 256QAM, PP4, R=2/3, <math>\Delta/T_U=1/16</math>} and signal bandwidth 8MHz in exciter.</li> <li>3. Use Gaussian channel without additional noise or interference.</li> <li>4. Set the receiver input level to -50 dBm.</li> <li>5. Verify the received signal carrying services using quality measurement procedure 2 (QMP2).</li> <li>6. Disable FEF from broadcast.</li> <li>7. After possible short interruption on the received service just when FEF is disabled, the receiver shall recover by itself and continue decoding of the service.</li> <li>8. Verify the received signal carrying services using quality measurement procedure 2 (QMP2).</li> <li>9. Enable FEF in broadcast.</li> <li>10. After possible short interruption on the received service just when FEF is enabled, the receiver shall recover by itself and continue decoding of the service.</li> <li>11. Verify the received signal carrying services using quality measurement procedure 2 (QMP2).</li> </ol> <p><b>Expected result:</b></p> <p>Broadcasting of FEF doesn't cause any harm to receiver and services carried within TS are decoded correctly.</p> <p>Receiver doesn't need any actions from end user to maintain reception when FEF is disabled and enabled.</p>
<i>Test result(s)</i>	
<i>Conformity</i>	<input type="checkbox"/> OK Fault <input type="checkbox"/> Major <input type="checkbox"/> Minor, define fail reason in comments
<i>Comments</i>	If possible describe if fault can be fixed with software update: <input type="checkbox"/> YES <input type="checkbox"/> NO Describe more specific faults and/or other information
<i>Date</i>	<i>Sign</i>

<i>Test Case</i>	<b>Task 3:45 DVB-T2: Input Mode A (RBM when FEF present)</b>
<i>Section</i>	NorDig Unified 3.4.3
<i>Requirement</i>	<p>Within the NorDig IRD specification the concept of "DVB-T2 mode" includes e.g. (the list is not exhaustive):</p> <ul style="list-style-type: none"> <li>• Input Mode A (single PLP) or Input Mode B (Multiple PLPs – Common PLP, Type 1 and 2 up to the maximum allowed figure 255)</li> </ul> <p>DVB-T2 signal introduces a receiver buffer model (RBM) which is fundamental when it comes to receive signals where carried transport stream doesn't have constant bit rate as it is case when FEF is present.</p>
<i>IRD Profile(s)</i>	Basic, IRD, DVB-T2
<i>Test procedure</i>	<p><b>Purpose of test:</b> To verify that received DVB-T2 signal can stress the receiver RBM based on DVB V&amp;V tests.</p> <p><b>Equipment:</b></p>

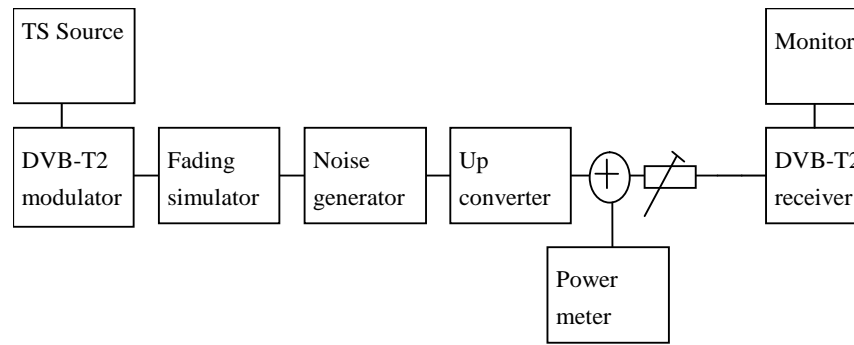

Use Mode A (Single PLP) and following deviations to parameter settings defined in 2.3.7 Summary of DVB-T2 modes for NU\_S34:

PLP Code rate	3/5
PAPR	TR & L1-ACE
PAPR $V_{clip}$	3.55V
L1_ ACE_MAX	0.1
ISSY	Enabled
FEF	Yes
Auxiliary streams	Not used
Frames per superframe ( $N_{T2}$ )	6
FEF P1: S1 Value	2
FEF P1: S2 Value	1
T2 P1:S2 Value	1
FEF size	595420 samples
Design delay	719388 samples
BUFS	2097152

The DVB-T2 signal shall contain a FEF with PRBS content and with a FEF interval of 6 T2 frames.

The size of the PRBS FEF is 595420 samples and T2 frame size  $L_f=62$  symbols.

T2 frames shall carry a TS. TS bitrate is restricted to maximum of 4.5MBit/s.

The content of the TS is maximed to TS bit rate.

TS contains at least one service.

The configuration files are available for download on NorDig homepages.

Using DVB-T2 mode specified ( $L_f=62$  symbols) below allows total bit rate of 32.849069 Mbit/s. Using FEF and T2 frame size relation above, the TS bit rate is 31.406587 Mbit/s.

#### Test procedure:

1. Set up the test instruments.
2. Use the following DVB-T2 mode {32K extended, 256QAM, PP4,  $R=3/5$ ,  $\Delta/T_U=1/16$ } and signal bandwidth 8MHz in exciter according to description above of the DVB-T2 signal.
3. Use Gaussian channel without additional noise or interference.
4. Set the receiver input level to -50 dBm.

	<p>5. Perform channel search and make sure the receiver has deleted any possible old service on the channel list.</p> <p>6. Verify the received signal carrying services using quality measurement procedure 2 (QMP2).</p> <p><b>Expected result:</b></p> <p>Broadcasting of DVB-T2 signal according to signal description which stresses the RBM is demodulated correctly and services carried within TS are decoded correctly.</p>
<i>Test result(s)</i>	
<i>Conformity</i>	<input type="checkbox"/> <b>OK Fault</b> <input type="checkbox"/> Major <input type="checkbox"/> Minor, define fail reason in comments
<i>Comments</i>	If possible describe if fault can be fixed with software update: <input type="checkbox"/> <b>YES</b> <input type="checkbox"/> <b>NO</b> Describe more specific faults and/or other information
<i>Date</i>	<i>Sign</i>

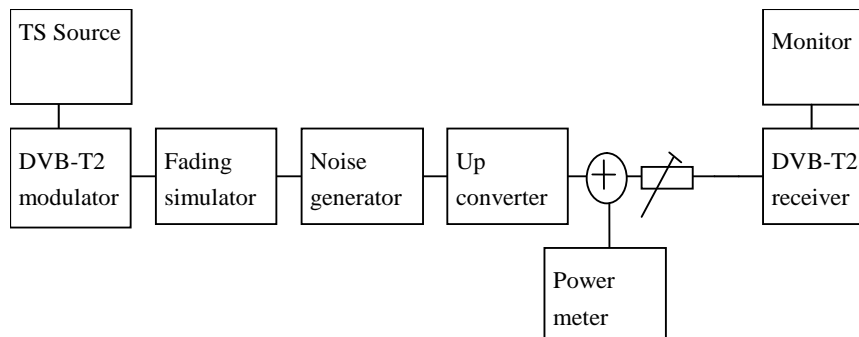
<i>Test Case</i>	<b>Task 3:46 DVB-T2: Auxiliary streams</b>		
<i>Section</i>	NorDig Unified 3.4.3		
<i>Requirement</i>	The NorDig terrestrial IRD is not required to demodulate or decode the content of FEF parts and auxiliary streams, but the existence of FEFs and/or auxiliary streams shall not cause receiver to malfunction.		
<i>IRD Profile(s)</i>	Basic, IRD, DVB-T2		
<i>Test procedure</i>	<p><b>Purpose of test:</b> To verify that broadcasting of AUX doesn't cause any harm for the receiver.</p> <p><b>Equipment:</b></p>  <p>Use Mode A (Single PLP) and following deviations to parameter settings defined in 2.3.7 Summary of DVB-T2 modes in DVB-T2 test tasks:</p> <table border="1" style="margin-left: auto; margin-right: auto;"> <tr> <td>Auxiliary streams</td> <td>Yes</td> </tr> </table> <p>The DVB-T2 signal shall contain auxiliary stream in T2 dummy cells with T2 frame size of Lf=62 symbols. The DVB-T2 signal with specified mode parameters contains 221 dummy cells.</p> <p>Auxiliary stream content is T2-TX-SIG according to specification ETSI TS 102 992. Tested receiver is not required to interpret content in the T2-TX-SIG. The T2-TX-SIG information is carried within 193 dummy cells out the available 221 dummy cells.</p>	Auxiliary streams	Yes
Auxiliary streams	Yes		

	<p>Configuration of T2-TX-SIG signaling is following:  M=15 (maximum number of transmitters signaled)  N=8 (number of cells per symbols and frame)  L= 15 (repetition rate for T2 frames)</p> <p>T2 frames shall carry a TS. TS bitrate should be maximized to the capacity the T2 frame size can deliver.</p> <p>The content within TS is maximized to bit rate the TS can carry, with other words, minimize the NULL packets in TS.</p> <p>TS contains at least one service.</p> <p><b>Test procedure:</b></p> <ol style="list-style-type: none"> <li>1. Set up the test instruments.</li> <li>2. Use the following DVB-T2 mode {32K extended, 256QAM, PP4, R=2/3, Δ/T<sub>U</sub>=1/16} and signal bandwidth 8MHz in exciter.</li> <li>3. Use Gaussian channel without additional noise or interference.</li> <li>4. Set the receiver input level to -50 dBm.</li> <li>5. Verify the received signal carrying services using quality measurement procedure 2 (QMP2).</li> </ol> <p><b>Expected result:</b>  Broadcasting of auxiliary stream doesn't cause any harm to receiver and services carried within TS are decoded correctly.</p>
<b>Test result(s)</b>	
<b>Conformity</b>	<input type="checkbox"/> <b>OK Fault</b> <input type="checkbox"/> Major <input type="checkbox"/> Minor, define fail reason in comments
<b>Comments</b>	If possible describe if fault can be fixed with software update: <input type="checkbox"/> <b>YES</b> <input type="checkbox"/> <b>NO</b> Describe more specific faults and/or other information
<b>Date</b>	<b>Sign</b>

<b>Test Case</b>	<b>Task 3:47 DVB-T2: Reception of version 1.1.1</b>
<b>Section</b>	Nordig Unified 3.4.3
<b>Requirement</b>	Receiver shall be able to receive version v1.1.1 of the DVB-T2 system when ISSY is enabled.
<b>IRD profile(s)</b>	Basic, IRD, DVB-T2
<b>Test procedure</b>	<p><b>Purpose of test:</b>  To verify receiver is able to receive DVB-T2 version 1.1.1 when ISSY is enabled.</p> <p><b>Equipment:</b></p>

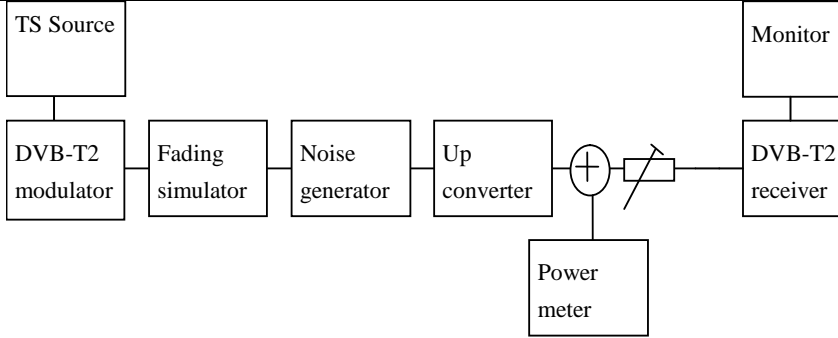

	<div style="text-align: center;">  </div> <p>Use Mode A (Single PLP) and following deviations to parameter settings defined in 2.3.7 Summary of DVB-T2 modes in DVB-T2 test tasks:</p> <table border="1" style="margin-left: auto; margin-right: auto;"> <tr> <td>Version</td> <td>1.1.1</td> </tr> <tr> <td>ISSY</td> <td>Enabled or disabled</td> </tr> </table> <p>The DVB-T2 modulator is configured with parameters 8 MHz signal bandwidth, 32k extended, 256QAM rotated, GI1/16, PP4, R2/3, L1-ACE &amp; TR PAPR, <math>L_f=62</math>.</p> <p><b>Test procedure:</b></p> <ol style="list-style-type: none"> <li>1. Tune receiver to signal with configuration according to measurement result.</li> <li>2. Verify the services are decoded correctly.</li> </ol> <p><b>Expected result:</b> Receiver is able to decode services correctly for DVB-T2 system v1.1.1 when ISSY is enabled or disabled.</p>	Version	1.1.1	ISSY	Enabled or disabled					
Version	1.1.1									
ISSY	Enabled or disabled									
<p><b>Test result(s)</b></p>	<p>Measurement result:</p> <table border="1" style="margin-left: auto; margin-right: auto;"> <thead> <tr> <th>Mode</th> <th>ISSY</th> <th>NOK or OK</th> </tr> </thead> <tbody> <tr> <td>32k extended, 256QAM rotated, GI1/16, PP4, R2/3, L1-ACE &amp; TR PAPR, <math>L_f=62</math></td> <td>Disabled</td> <td></td> </tr> <tr> <td>32k extended, 256QAM rotated, GI1/16, PP4, R2/3, L1-ACE &amp; TR PAPR, <math>L_f=62</math></td> <td>Enabled</td> <td></td> </tr> </tbody> </table>	Mode	ISSY	NOK or OK	32k extended, 256QAM rotated, GI1/16, PP4, R2/3, L1-ACE & TR PAPR, $L_f=62$	Disabled		32k extended, 256QAM rotated, GI1/16, PP4, R2/3, L1-ACE & TR PAPR, $L_f=62$	Enabled	
Mode	ISSY	NOK or OK								
32k extended, 256QAM rotated, GI1/16, PP4, R2/3, L1-ACE & TR PAPR, $L_f=62$	Disabled									
32k extended, 256QAM rotated, GI1/16, PP4, R2/3, L1-ACE & TR PAPR, $L_f=62$	Enabled									
<p><b>Conformity</b></p>	<p><input type="checkbox"/> OK Fault <input type="checkbox"/> Major <input type="checkbox"/> Minor, define fail reason in comments</p>									
<p><b>Comments</b></p>	<p>If possible describe if fault can be fixed with software update: <input type="checkbox"/> YES <input type="checkbox"/> NO Describe more specific faults and/or other information</p>									
<p><b>Date</b></p>	<p style="text-align: right;"><b>Sign</b></p>									
<p><b>Test Case</b></p>	<p><b>Task 3:48 DVB-T2: Tuning/Scanning Procedures: Automatic channel search for the same service bouquet</b></p>									
<p><b>Section</b></p>	<p>NorDig Unified 3.4.4.4</p>									
<p><b>Requirement</b></p>	<p>The IRD shall provide an automatic search that finds all of the multiplexes and services in the whole (supported) frequency range, see NorDig specification. The logic of the automatic search function shall be as follows: If any services are detected during the automatic search the current service list shall be replaced by the new service list.</p>									

If no services are detected during the automatic search the current service list shall be kept or deleted.

The IRD shall only display a service once in the service list (i.e. avoiding duplicate of the same services), even if the same service (same triplet original\_network\_id, transport\_stream\_id and service\_id) is received from multiple transmitters. If the same service can be received from several transmitters, the one with best reception quality shall be selected. The criteria for selection of the best received service (i.e. best reception quality) shall be based on the combination of the signal strength and signal quality according to NorDig specification.

**IRD profile(s)** Basic, IRD, DVB-T2

**Test procedure**

**Purpose of test:**

To verify the best service selection in automatic channel search when the content of the transport stream is the same on several transmitters.

**Equipment:**

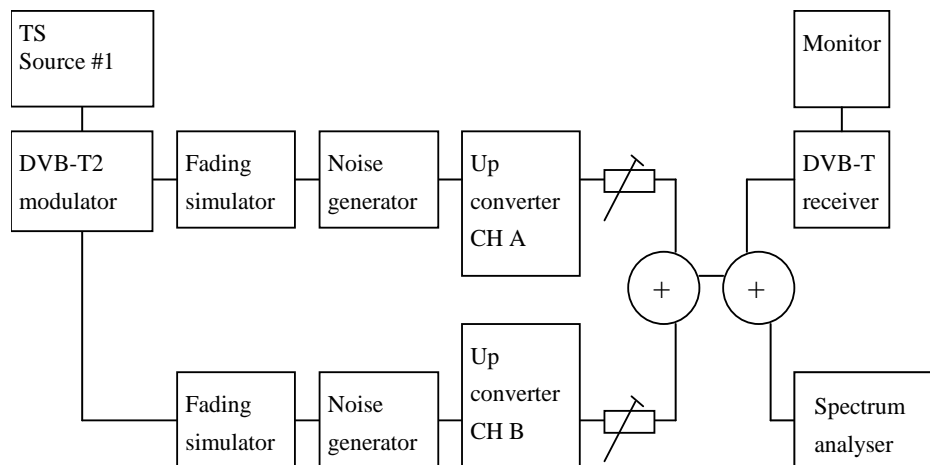

**Channels A and B**

**TS source #1**

**ONID=8945**

**Network ID=1000**

**Network Name=Net1**

**TSID=100**

**Services**

Name	SID	Logic Ch No
S1	1	1
S2	2	2
S3	3	3
S4	4	4

**S1 1 1**

**S2 2 2**

**S3 3 3**

**S4 4 4**

There is a possibility to receive broadcasts from several transmitters simultaneously in DVB-T2 networks. These transmitters can have exactly the same content, but are transmitted on different channels (frequencies). Therefore, it is important that the receiver can choose by an automatic channel search the services with the best reception quality.

Test to verify broadcast where equal services are broadcasted simultaneously over DVB-T and DVB-T2 networks is not required.

	<p>Reception quality can be divided into two different parameters:</p> <ul style="list-style-type: none"> <li>• Signal strength</li> <li>• Signal quality</li> </ul> <p>Signal quality can be divided into two main parameters:</p> <ul style="list-style-type: none"> <li>• Signal-to-noise ratio (C/N)</li> <li>• Bit error rate before BCH (BER before BCH in DVB-T2 system)</li> </ul> <p>Channels A and B shall not be equal.</p> <p>Relative signal levels can be observed on spectrum analyser.</p> <p><math>\Delta S</math> refers to difference in SSI according to [1] Annex D.</p> <p><math>\Delta Q</math> refers to difference in SQI according to [1] Annex D.</p> <p>AWGN refers to Additive White Gaussian Noise.</p> <p>As a pre-requisite to perform this test, IRD shall correctly pass the following tasks:</p> <ul style="list-style-type: none"> <li>• Task 3:51 Verification of Signal Strength Indicator (SSI)</li> <li>• Task 3:52 Verification of Signal Quality Indicator (SQI)</li> </ul> <p>Measurement record2 shows the minimum tests that shall be performed. Signal levels and signal quality (i.e added AWGN) can be adjusted from the initial values shown to ensure the required <math>\Delta S</math> and <math>\Delta Q</math> conditions are met.</p> <p><b>Test procedure:</b></p> <ol style="list-style-type: none"> <li>1. Configure the transport stream and setup the instruments. Use the DVB-T2 mode 32k extended bandwidth, 256QAM rotated, GI1/16, PP4, R2/3, L1-ACE &amp; TR PAPR.</li> <li>2. Set the signal level of the both carriers CH A and CH B to the same level. The signal level shall correspond good reception quality (no errors in decoded video).</li> <li>3. Perform automatic channel search. The logic of the automatic search function shall be as follows: <ul style="list-style-type: none"> <li>If any services are detected during the automatic search the current service list shall be replaced by the new service list.</li> <li>If no services are detected during the automatic search the current service list shall be kept or deleted.</li> </ul> </li> <li>4. Check that the channel list has services configured in the transport stream.</li> <li>5. Check that the services on the channel list is listed once and not duplicated. Check which channel is received by trying to attenuate the signal level. The services from received channel are frozen when the signal level is too low. Restore the attenuations to a level before it was changed.</li> <li>6. Fill in OK or NOK in the measurement record depending if the services were deleted.</li> <li>7. Fill in OK or NOK in the measurement record 2 depending if the services were installed from expected channel.</li> </ol> <p>Repeat the test for the rest of the test points in the measurement record 2.</p> <p><b>Expected result:</b> All the test results are OK.</p>
<b>Test result(s)</b>	Measurement record 1:



	<b>Requirement</b>	<b>Result OK or NOK</b>
	<p>The logic of the automatic search function shall be as follows:</p> <p style="padding-left: 40px;">If any services are detected during the automatic search the current service list shall be replaced by the new service list.</p> <p style="padding-left: 40px;">If no services are detected during the automatic search the current service list shall be kept or deleted.</p>	
	<p>After automatic channel search the channel lists do not contain duplicated services.</p>	
	<p>Measurement record 2 is found on next page.</p>	
<b>Conformity</b>	<input type="checkbox"/> <b>OK Fault</b> <input type="checkbox"/> Major <input type="checkbox"/> Minor, define fail reason in comments	
<b>Comments</b>	<p>If possible describe if fault can be fixed with software update: <input type="checkbox"/> <b>YES</b> <input type="checkbox"/> <b>NO</b></p> <p>Describe more specific faults and/or other information</p>	
<b>Date</b>	<b>Sign</b>	

Test point	Channel A, f = 474 MHz			Channel B, f = 690 MHz			Required $\Delta S$ [%]	Required $\Delta Q$ [%]	Receiver channel choice	Expected channel choice	Result OK/ NOK	Reference conditions in flowchart [1] Annex D
	Initial signal level [dBm]	Initial CNR [dB]	Additional BER Impairment	Initial signal level [dBm]	Initial CNR [dB]	Additional BER Impairment						
1	-60	no AWGN	None	-60	no AWGN	None	<10	<10		A or B		1,2,3,5,6 or 7
2	-50	no AWGN	None	-65	no AWGN	None	>10	<20		A		1 or 8
3	-65	no AWGN	None	-50	no AWGN	None	>10	<20		B		4 or 5
4	-61	CNR@QMP2+1dB	None	-60	CNR@QMP2+0.5dB	None	<10	<20		A		3
5	-60	CNR@QMP2+0.5dB	None	-61	CNR@QMP2+1dB	None	<10	<20		B		7
6	-61	no AWGN	None	-60	CNR@QMP2+1dB	None	<10	>20		A		2
7	-60	CNR@QMP2+1dB	None	-61	no AWGN	None	<10	>20		B		6
8	-50	no AWGN	None	-65	CNR@QMP2+1dB	None	>10	>20		A		1
9	-65	CNR@QMP2+1dB	None	-50	no AWGN	None	>10	>20		B		5

Table 20 Measurement record 2 for test Task 3:48.

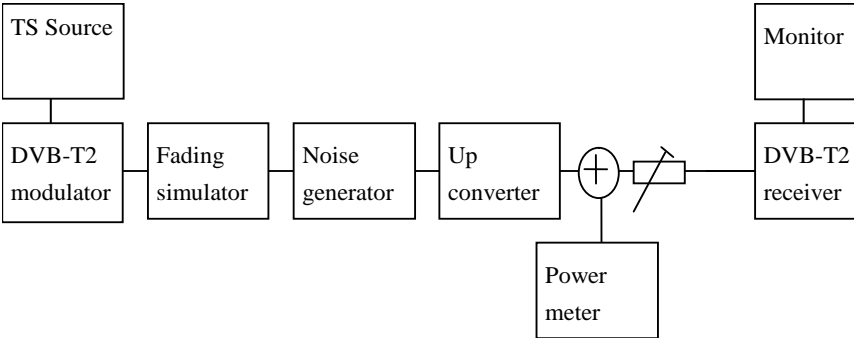
<b>Test Case</b>	<b>Task 3:49 DVB-T2: Tuning/Scanning Procedures: Basic status check</b>										
<b>Section</b>	NorDig Unified 3.4.4.2										
<b>Requirement</b>	<p>The IRD shall provide at least a basic status check function (accessible through the Navigator) that presents reception quality information for a selected frequency (currently viewed by the user).          The basic status check shall include:</p> <ul style="list-style-type: none"> <li>• channel id</li> <li>• center frequency</li> <li>• Signal Strength Indicator, SSI (%)</li> <li>• Signal Quality Indicator, SQI (%)</li> </ul>										
<b>IRD Profile(s)</b>	Basic, IRD, DVB-T2										
<b>Test procedure</b>	<p><b>Purpose of test:</b> To verify that specified status information is displayed correctly.</p> <p><b>Equipment:</b></p>  <pre> graph LR     TS[TS Source] --- M1(( )) --- M1 --- DVB-T2[DVB-T2 modulator]     DVB-T2 --- F[Fading simulator]     F --- N[Noise generator]     N --- U[Up converter]     U --- P((+))     P --- PM[Power meter]     P --- S(( ))     S --- DVB-T2R[DVB-T2 receiver]     DVB-T2R --- M2(( )) --- M2 --- MON[Monitor]     style M1 fill:none,stroke:none     style M2 fill:none,stroke:none     style S fill:none,stroke:none     </pre> <p><b>Test procedure:</b></p> <ol style="list-style-type: none"> <li>1. Configure the test setup</li> <li>2. Tune IRD to received frequency</li> <li>3. Verify the basic status check functionality</li> <li>4. Write in the results in the measurement record</li> </ol> <p><b>Expected result:</b> All test results in measurement record are OK.</p>										
<b>Test result(s)</b>	<p>Measurement record</p> <table border="1" data-bbox="437 1525 1289 1688"> <thead> <tr> <th>Requirement</th> <th>NOK or OK</th> </tr> </thead> <tbody> <tr> <td>Navigator has status check function.</td> <td></td> </tr> <tr> <td>The function shows the channel id and center frequency.</td> <td></td> </tr> <tr> <td>The function shows signal strength indicator SSI in %.</td> <td></td> </tr> <tr> <td>The function has reception quality indicator SQI in %.</td> <td></td> </tr> </tbody> </table>	Requirement	NOK or OK	Navigator has status check function.		The function shows the channel id and center frequency.		The function shows signal strength indicator SSI in %.		The function has reception quality indicator SQI in %.	
Requirement	NOK or OK										
Navigator has status check function.											
The function shows the channel id and center frequency.											
The function shows signal strength indicator SSI in %.											
The function has reception quality indicator SQI in %.											
<b>Conformity</b>	<input type="checkbox"/> OK Fault <input type="checkbox"/> Major <input type="checkbox"/> Minor, define fail reason in comments										
<b>Comments</b>	<p>If possible describe if fault can be fixed with software update: <input type="checkbox"/> YES <input type="checkbox"/> NO          Describe more specific faults and/or other information</p>										
<b>Date</b>	<b>Sign</b>										

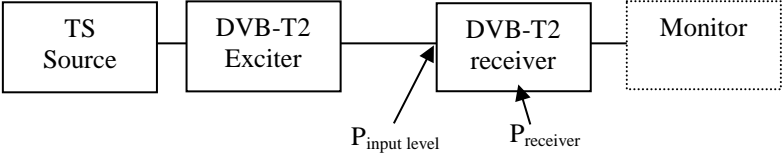
<b>Test Case</b>	<b>Task 3:50 DVB-T2: Verification of Signal Strength Indicator (SSI)</b>
<b>Section</b>	NorDig Unified 3.4.4.6
<b>Requirement</b>	<p>The NorDig IRD shall be provided with a signal strength indicator (SSI). The value for the SSI shall be referred to the IRD RF signal input.</p> <p>The NorDig IRD shall be able to determine signal strength within a range starting from 15 dB lower than the reference signal level defined in (1) and up to 35dB above that value or maximum signal input level defined in section (1)</p> <p>The absolute accuracy shall be <math>\pm 5</math> dB at RF signal input levels -80 dBm to -60 dBm and <math>\pm 7</math> dB for RF signal input levels higher than -60 dBm.</p> <p>The relative accuracy should be <math>\pm 3</math> dB between center frequencies within one frequency band, e.g. VHF Band III or UHF Band IV/V, supported by the receiver.</p> <p>Signal strength indicator shall have a relative value within a range from 0% to 100% and with a resolution of 1%.</p> <p>The signal strength indicator shall be updated regularly once per second.</p>
<b>IRD Profile(s)</b>	Basic, IRD, DVB-T2
<b>Test procedure</b>	<p><b>Purpose of test:</b> To verify the correct functionality of the signal strength indicator.</p> <p><b>Equipment:</b></p>  <pre> graph LR     TS[TS Source] --&gt; Exc[DVB-T2 Exciter]     Exc --&gt; Rec[DVB-T2 receiver]     Rec -.-&gt; Mon[Monitor]     </pre> <p>Gaussian channel profile used i.e. no need for fading simulator.</p> <p>In this test, the signal input level <math>P_{input\ level}</math> at the RF input must be known.</p> <p>The test procedure assumes that the <math>P_{receiver}</math> is not displayed by the receiver. If the <math>P_{receiver}</math> is displayed by the receiver this test procedure can be simplified.</p> <p><b>Test procedure:</b></p> <p>Verify the SSI value:</p> <ol style="list-style-type: none"> <li>1. Set-up the test system</li> <li>2. Determine the attenuation of the test system so that the signal input level at the receiver input is known in the measured frequencies.</li> <li>3. Use the following DVB-T2 mode {32K extended, 256QAM, PP4, <math>R=2/3, \Delta/T_0=1/16</math>} and signal bandwidth of 8MHz.</li> <li>4. Set the up-converter to frequency 474MHz (K21).</li> <li>5. Set the signal level into the receiver according to measurement record 1.</li> <li>6. Do the channel search.</li> <li>7. Fill in the SSI value displayed by the receiver in the measurement record 1.</li> <li>8. <math>SSI_{min}</math> and <math>SSI_{max}</math> defines the allowed range of the displayed value.</li> <li>9. Fill in the measurement record 1 OK or NOK depending of the displayed SSI value.</li> </ol>

10. Measure rest of the frequencies and DVB-T2 modes.
11. Fill in the measurement record 1.

Verify the relative error:

1. Convert the displayed SSI values to  $P_{\text{receiver}}$  [dBm]. Select the correct formula for calculating  $P_{\text{receiver}}$  according to the displayed SSI value as shown below:

$$\begin{aligned}
 P_{\text{receiver}} &= (3/2) * (\text{SSI} - 90) + 20 + P_{\text{reference}} && \text{if } 90 \leq \text{SSI} < 100 \\
 P_{\text{receiver}} &= (1/4) * (\text{SSI} - 10) + P_{\text{reference}} && \text{if } 10 \leq \text{SSI} < 90 \\
 P_{\text{receiver}} &= (3/2) * \text{SSI} - 15 + P_{\text{reference}} && \text{if } 0 \leq \text{SSI} < 10
 \end{aligned}$$

2. Fill in the dBm values in the measurement record 2 for corresponding signal input level.
3. Calculate the average value of the  $P_{\text{receiver}}$  values in three frequencies within a frequency band.
4. Verify the calculated  $P_{\text{receiver}}$  [dBm] values are within  $\pm 3$  dB from the average value.
5. Fill in the measurement record 2 OK or NOK.

**Expected result:**

All the measurements shall be OK.

Displayed SSI shall be displayed in [%] and updated once per second.

**Test result(s)**

Measurement record 1:

32KE,256QAMR,PP4,R2/3,G1/16,8MHz, $P_{\text{reference}}=-78\text{dBm}$ , $f=666\text{MHz}$				
$P_{\text{input level}}$ [dBm]	SSI [%]	$SSI_{\text{min}}$ [%]	$SSI_{\text{max}}$ [%]	NOK or OK
-40		97	100	
-50		91	100	
-60		62	92	
-70		22	62	
-80		5	22	
-95		0	3	

32KE,256QAMR,PP4,R2/3,G1/16,8MHz, $P_{\text{reference}}=-78\text{dBm}$ , $f=474\text{MHz}$				
$P_{\text{input level}}$ [dBm]	SSI [%]	$SSI_{\text{min}}$ [%]	$SSI_{\text{max}}$ [%]	NOK or OK
-40		97	100	
-50		91	100	
-60		62	92	
-70		22	62	
-80		5	22	
-95		0	3	

32KE,256QAMR,PP4,R2/3,G1/16,8MHz, $P_{\text{reference}}=-78\text{dBm}$ , $f=786\text{MHz}$				
$P_{\text{input level}}$ [dBm]	SSI [%]	$SSI_{\text{min}}$ [%]	$SSI_{\text{max}}$ [%]	NOK or OK
-40		97	100	
-50		91	100	
-60		62	92	
-70		22	62	
-80		5	22	
-95		0	3	



32KN,256QAMR,PP4,R2/3,G19/256,7MHz, P <sub>reference</sub> =-78dBm, f=177.5MHz				
P <sub>input level</sub> [dBm]	SSI [%]	SSI <sub>min</sub> [%]	SSI <sub>max</sub> [%]	NOK or OK
-40		97	100	
-50		91	100	
-60		62	92	
-70		22	62	
-80		5	22	
-95		0	3	

32KN,256QAMR,PP4,R2/3,G19/256,7MHz, P <sub>reference</sub> =-78dBm, f=198.5MHz				
P <sub>input level</sub> [dBm]	SSI [%]	SSI <sub>min</sub> [%]	SSI <sub>max</sub> [%]	NOK or OK
-40		97	100	
-50		91	100	
-60		62	92	
-70		22	62	
-80		5	22	
-95		0	3	

32KN,256QAMR,PP4,R2/3,G19/256,7MHz, P <sub>reference</sub> =-78dBm, f=226.5MHz				
P <sub>input level</sub> [dBm]	SSI [%]	SSI <sub>min</sub> [%]	SSI <sub>max</sub> [%]	NOK or OK
-40		97	100	
-50		91	100	
-60		62	92	
-70		22	62	
-80		5	22	
-95		0	3	

32KE,256QAMR,PP4,R3/5,G19/256,8MHz, P <sub>reference</sub> =-80dBm, f=666MHz				
P <sub>input level</sub> [dBm]	SSI [%]	SSI <sub>min</sub> [%]	SSI <sub>max</sub> [%]	NOK or OK
-40		99	100	
-50		92	100	
-60		70	93	
-70		30	70	
-80		5	38	
-95		0	5	

32KE,256QAMR,PP2,R3/4,G1/8,8MHz, P <sub>reference</sub> =-76dBm, f=666MHz				
P <sub>input level</sub> [dBm]	SSI [%]	SSI <sub>min</sub> [%]	SSI <sub>max</sub> [%]	NOK or OK
-40		96	100	
-50		86	100	
-60		54	93	
-70		14	70	
-80		3	38	
-95		0	5	

Measurement record 2:

P <sub>input level</sub> [dBm]	P <sub>receiver</sub> [dBm] @474MHz	P <sub>receiver</sub> [dBm] @666MHz	P <sub>receiver</sub> [dBm] @786MHz	Average	NOK or OK

	-40					
	-50					
	-60					
	-70					
	-80					
	-95					
	P <sub>input level</sub> [dBm]	P <sub>receiver</sub> [dBm] @177.5MHz	P <sub>receiver</sub> [dBm] @198.5MHz	P <sub>receiver</sub> [dBm] @226.5MHz	Average	NOK or OK
	-40					
	-50					
	-60					
	-70					
	-80					
-95						
<b>Conformity</b>	<input type="checkbox"/> <b>OK Fault</b> <input type="checkbox"/> Major <input type="checkbox"/> Minor, define fail reason in comments					
<b>Comments</b>	If possible describe if fault can be fixed with software update: <input type="checkbox"/> <b>YES</b> <input type="checkbox"/> <b>NO</b> Describe more specific faults and/or other information					
<b>Date</b>				<b>Sign</b>		

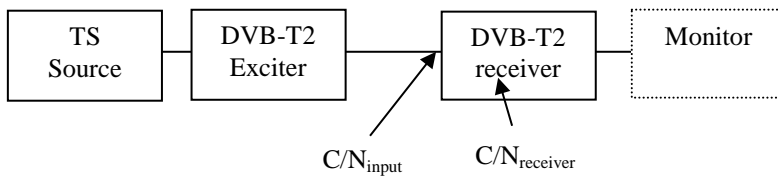
<b>Test Case</b>	<b>Task 3:51 DVB-T2: Verification of Signal Quality Indicator (SQI)</b>
<b>Section</b>	NorDig Unified 3.4.4.7.2
<b>Requirement</b>	<p>The NorDig IRD for DVB-T2 shall be provided with a signal quality indicator (SQI). The value for the SQI shall be referred to a PLP in the received signal at the NorDig IRD RF signal input.</p> <p>The signal quality indicator shall have a relative value within a range from 0% to 100% and with a resolution of 1%.</p> <p>The signal quality indicator shall be updated regularly at least once per second.</p> <p>The signal quality indicator (SQI) in [%] shall be calculated for the received PLP according to the formulas defined in [1].</p>
<b>IRD Profile(s)</b>	Basic, IRD, DVB-T2
<b>Test procedure</b>	<p><b>Purpose of test:</b> To verify the correct functionality of the signal quality indicator.</p> <p><b>Equipment:</b></p>  <p>Gaussian channel profile used i.e. no need for fading simulator.</p> <p>C/N<sub>input</sub> refers to generated DVB-T2 signal C/N at receiver input.</p> <p>C/N<sub>receiver</sub> refers to C/N determined by the receiver under test.</p>

$$C/N_{rel} = C/N_{input} - C/N_{NorDigP1}$$

$C/N_{NorDigP1}$  refers to table 3.11 at [1].

First we need to define the required  $C/N_{input}$  for the QMP2. After that we know what is the expected rescale of  $BER\_SQI_{min}$  and  $BER\_SQI_{max}$ .

**Test procedure:**

1. Set up the test instruments
2. Use the following DVB-T2 mode {32KE, 256QAMR, PP4, R3/5, G19/256} and signal bandwidth 8MHz.
3. Set the up-converter to frequency 666MHz (K45).
4. Do the channel search.
5. Determine the lowest required  $C/N$  by adjusting the  $C/N_{input}$  until the quality measurement procedure 2 error free video is fulfilled.
6. Fill in the measurement record 1 the  $C/N_{input}$  value defined as  $C/N_{receiver}$ . Later in this test procedure the value  $C/N_{receiver}$  is used for rescaling of the  $BER\_SQI_{min}$  and  $BER\_SQI_{max}$  values.
7. Decrease the  $C/N_{input}$  in 1dB step starting from highest value in measurement record 2.
8. Fill in the displayed SQI in the measurement record 2.
9. Repeat the test for the DVB-T2 mode {32KE, 256QAMR, PP4, R2/3, G1/16} and signal bandwidth 8MHz.
10. Repeat the test for the DVB-T2 mode {32KE, 256QAMR, PP2, R3/4, G1/8} and signal bandwidth 8MHz.
11. Do the calculations in the rest of the test procedure.

$SQI_{min}$  calculations:

12. Calculate  $SQI_{min}$  for all  $C/N_{input}$  values using formulas
 

$SQI_{min} = 0,$	if $C/N_{rel} - 1 < -3$ dB
$SQI_{min} = (C/N_{rel} - 1 + 3) * BER\_SQI_{min},$	if $-3$ dB $\leq C/N_{rel} - 1 \leq 3$ dB
$SQI_{min} = 100,$	if $C/N_{rel} - 1 > 3$ dB.

$SQI_{max}$  calculations:

13. Calculate  $SQI_{max}$  for all  $C/N_{input}$  values using formulas
 

$SQI_{max} = 0,$	if $C/N_{rel} + 1 < -3$ dB
$SQI_{max} = (C/N_{rel} + 1 + 3) * BER\_SQI_{max},$	if $-3$ dB $\leq C/N_{rel} + 1 \leq 3$ dB
$SQI_{max} = 100,$	if $C/N_{rel} + 1 > 3$ dB.

Where  $BER\_SQI_{min}$  is:

$BER\_SQI_{min} = 0,$	if $C/N_{rel} - 1 - (C/N_{receiver} - X) < -2.4$ dB
$BER\_SQI_{min} = 100/15,$	if $-2.4$ dB $\leq C/N_{rel} - 1 - (C/N_{receiver} - X) \leq -2$ dB
$BER\_SQI_{min} = 100/6,$	if $C/N_{rel} - 1 - (C/N_{receiver} - X) > -2$ dB.

Where  $BER\_SQI_{max}$  is:

$BER\_SQI_{max} = 0,$	if $C/N_{rel} + 1 - (C/N_{receiver} - X) < -2.4$ dB
$BER\_SQI_{max} = 100/15,$	if $-2.4$ dB $\leq C/N_{rel} + 1 - (C/N_{receiver} - X) \leq -2$ dB
$BER\_SQI_{max} = 100/6,$	if $C/N_{rel} + 1 - (C/N_{receiver} - X) > -2$ dB.

And where X is:

X = 17.6 for 32KE, 256QAMR, PP4, R3/5, G19/256, 8MHz  
 X = 19.0 for 32KE, 256QAMR, PP4, R2/3, G1/16, 8MHz  
 X = 20.8 for 32KE, 256QAMR, PP2, R3/4, G1/8, 8MHz

**Expected result:**

All the test result are OK.  
 The signal quality indicator is updated regularly once per second.

**Test result(s)**

Measurement record 1:

DVB-T2 mode	Required C/N <sub>receiver</sub> [dB] (30 sec error free video)
32KE 256QAMR PP4 R3/5 G19/256 8MHz	
32KE 256QAMR PP4 R2/3 G1/16 8MHz	
32KE 256QAMR PP2 R3/4 G1/8 8MHz	

Measurement record 2:

32KE 256QAMR PP4 R3/5 G19/256 8MHz, C/N <sub>NorDigP1</sub> = 19.4dB				
C/N <sub>input</sub>	SQI[%]	SQI <sub>min</sub> [%]	SQI <sub>max</sub> [%]	NOK or OK
27				
26				
25				
24				
23				
22				
21				
20				
19				
18				
17				

32KE 256QAMR PP4 R2/3 G1/16 8MHz, C/N <sub>NorDigP1</sub> = 20.8dB				
C/N <sub>input</sub>	SQI[%]	SQI <sub>min</sub> [%]	SQI <sub>max</sub> [%]	NOK or OK
27				
26				
25				
24				
23				
22				
21				
20				
19				
18				
17				

32KE 256QAMR PP2 R3/4 G1/8 8MHz, C/N <sub>NorDigP1</sub> = 22.9dB				
C/N <sub>input</sub>	SQI[%]	SQI <sub>min</sub> [%]	SQI <sub>max</sub> [%]	NOK or OK

27				
26				
25				
24				
23				
22				
21				
20				
19				
18				
17				

Example for calculating SQI<sub>min</sub> and SQI<sub>max</sub> values for 256QAM R3/5 when C/N<sub>receiver</sub> = 17.7dB at QMP2 resulting to C/N<sub>receiver</sub> - X = 0.1dB where X = 17.6:

$$\begin{aligned} \text{CNR}_{\text{receiver}} @ \text{QMP2} &= 17.7 \\ (\text{C/N}_{\text{receiver}} - 17.6) @ \text{QMP2} &= 0.1 \\ \text{256QAM R3/5 C/NNorDigP1} &= 19.4 \end{aligned}$$

C/N input	C/Nrel	C/N error Min	C/Nrel error Min	BER_SQI Min	C/N error Max	C/Nrel error Max	BER_SQI Max	SQI Min	SQI Max	SQI measured 256QAM R3/5	OK or NOK
15	-4.4	-1	-5.4	0.0	1	-3.4	0.0	0	0		
16	-3.4	-1	-4.4	0.0	1	-2.4	0.0	0	0		
17	-2.4	-1	-3.4	0.0	1	-1.4	16.7	0	27		
17.6	-1.8	-1	-2.8	0.0	1	-0.8	16.7	0	37		
18	-1.4	-1	-2.4	0.0	1	-0.4	16.7	0	44		
19	-0.4	-1	-1.4	16.7	1	0.6	16.7	26	60		
20	0.6	-1	-0.4	16.7	1	1.6	16.7	43	77		
21	1.6	-1	0.6	16.7	1	2.6	16.7	60	94		
22	2.6	-1	1.6	16.7	1	3.6	16.7	76	100		
23	3.6	-1	2.6	16.7	1	4.6	16.7	93	100		
24	4.6	-1	3.6	16.7	1	5.6	16.7	100	100		
25	5.6	-1	4.6	16.7	1	6.6	16.7	100	100		
26	6.6	-1	5.6	16.7	1	7.6	16.7	100	100		
27	7.6	-1	6.6	16.7	1	8.6	16.7	100	100		

**Conformity**  OK  Fault  Major  Minor, define fail reason in comments

**Comments** If possible describe if fault can be fixed with software update:  YES  NO  
Describe more specific faults and/or other information

**Date** \_\_\_\_\_ **Sign** \_\_\_\_\_

<b>Test Case</b>	<b>Task 3:52 DVB-T2: Changes In Modulation Parameters</b>
<b>Section</b>	NorDig Unified 3.4.5
<b>Requirement</b>	The terrestrial NorDig IRD-T2 shall automatically recover from changes in the following P1, L1 pre-signalling data and L1 post-signalling parameters at the end of a superframe without a break in the received DVB-T2 signal. An error-free TS shall be available within five seconds for any P1 and/or L1 pre-signalling change. An error-free TS shall be output within five seconds for any L1 post-signalling FEF change and within two seconds for any other L1 post-signalling change.  The terrestrial NorDig IRD-T2 shall automatically recover from changes in the following P1, L1 pre-signalling and L1 post-signalling parameters occurring at any time followed by a break in the received signal. An error-free TS shall be output within five seconds.
<b>IRD Profile(s)</b>	Basic, IRD, DVB-T2
<b>Test procedure</b>	<b>Purpose of test:</b> To verify that receiver can automatically recover from changes in the specified P1, L1 pre-signaling and L1 post-signaling parameter occurring at any time followed by a break in the received signal and output an error free TS.

**Equipment:**

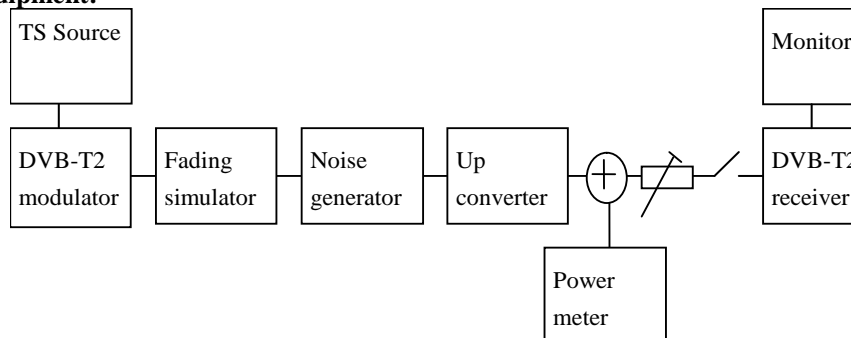

This test includes the use of L1 post-signalling configurable signaling fields. Those fields signalize transmission parameters per PLP.

Use Mode A (Single PLP) parameter settings defined in 2.3.7 Summary of DVB-T2 modes in DVB-T2 test tasks.

This test checks receiver capability to adapt to parameter changes in broadcasted DVB-T2 signal with break in the received RF signal. The receiver shall adapt to the received signal without any user action.

Different DVB-T2 modulators from different vendors may have different time to broadcast valid signal after the change of the parameter in the broadcasted signal. This time from parameter change to valid signal is excluded from the required receiver synchronization time. Therefore, the test operator needs to know this time and take it to account when calculating the receiver synchronization time.

Synchronisation time is not tested for rotated constellation changes, but receiver operability is tested on test Task 3:36.

Synchronisation time is not tested for time interleaving length changes, but receiver operability is tested on test Task 3:53.

**Test procedure:**

1. Setup the instruments
2. Use frequency 666MHz (K45)
3. Use the following DVB-T2 mode  
32k extended, 256QAM rotated, G1/16, R2/3 and signal bandwidth 8MHz.
4. Open the switch to break the received RF signal
5. Change the following transmission parameters in turn by changing the P1, L1 pre-signaling and L1 post signalling respectively  
 FFT size: 32K,16K,8K,4K,2K and 1K  
 Bandwidth extension: yes, no  
 PAPR: no, ACE, TR  
 Guard interval: G1/32, G1/16, G1/8, G1/4, G1/128, G19/128,G19/256  
 Pilot Pattern: PP2, PP4,PP6,PP7  
 Number of data symbols: 60, 62  
 Code Rate: R3/5, R2/3, R3/4  
 Modulation: 256 QAM  
 T2 system id change from 0 to 65535 (decimal)  
 Cell id change from 0 to 65535 (decimal)  
 Network id change (optional) from 0 to 65535 (decimal)  
 T2 version change from 1.2.1 to 1.3.1  
 PLP\_id change from 1 to 2 for TS carrying installed service(s) on the receiver

	<p>Change of FEF being disabled to enabled          Changing length of the FEF, when enabled, from 0 ms to 56.875 ms (other parameters needed to be changed are specified on test Task 3:44)</p> <ol style="list-style-type: none"> <li>6. Wait for the DVB-T2 modulator output to become valid and stable (this time is modulator specific – a minimum of 15 seconds is recommended for some modulators)</li> <li>7. Close the switch to enable the RF signal to the receiver and record the time taken to achieve QMP1.</li> <li>8. Verify receiver automatically adapts to new parameter settings without any user action.</li> </ol> <p><b>Expected result:</b></p> <p>The receiver can automatically recover from changes in the specified P1, L1 pre-signaling and L1 post-signaling parameter occurring at any time followed by a break in the received signal and output an error free TS within 5 seconds (excluding modulator stabilization time) without requiring a channel scan.</p> <p>The time limits in this clause exclude the time for the DVB-T2 modulator to output a stable and valid signal.</p>
<i>Test result(s)</i>	
<i>Conformity</i>	<input type="checkbox"/> <b>OK Fault</b> <input type="checkbox"/> Major <input type="checkbox"/> Minor, define fail reason in comments
<i>Comments</i>	If possible describe if fault can be fixed with software update: <input type="checkbox"/> <b>YES</b> <input type="checkbox"/> <b>NO</b> Describe more specific faults and/or other information
<i>Date</i>	<i>Sign</i>

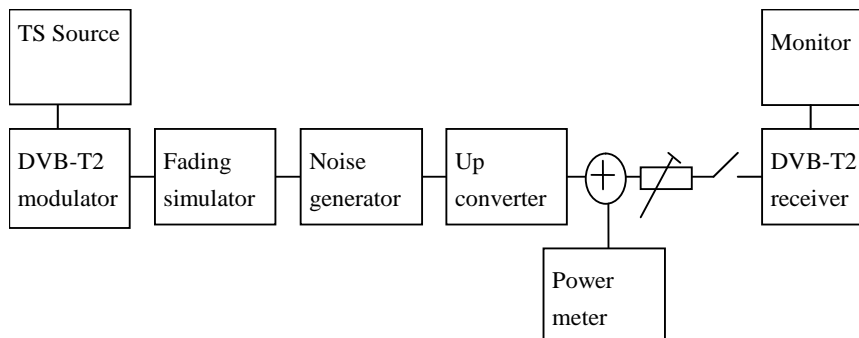
<i>Test Case</i>	<b>Task 3:53 DVB-T2: Time interleaving</b>
<i>Section</i>	NorDig Unified 3.4.8
<i>Requirement</i>	The NorDig IRD-T2 shall at least include time interleaving capability corresponding to the maximum time interleaving according to EN 302 755, i.e. $2^{19}+2^{15}$ OFDM cells for a data PLP and its common PLP together.
<i>IRD Profile(s)</i>	Basic, IRD, DVB-T2
<i>Test procedure</i>	<p><b>Purpose of test:</b>          To verify receiver time interleaving capability.</p> <p><b>Equipment:</b></p>  <p>Use Mode A (Single PLP) parameter settings defined in 2.3.7 Summary of DVB-T2 modes in DVB-T2 test tasks.</p>

	<p><b>Test procedure:</b></p> <ol style="list-style-type: none"> <li>1. Set up the test system</li> <li>2. Use DVB-T2 mode 32K extended, 256QAM rotated, PP7, R3/4, G1/128, 8MHz signal bandwidth on 666MHz</li> <li>3. Configure the interleaving type and length according to measurement record in test results.</li> </ol> <p><b>Expected result:</b></p> <p>The IRD able to decode services carried within TS correctly.</p>																												
<b>Test result(s)</b>	<p>Measurement record:</p> <table border="1"> <thead> <tr> <th>Interleaving type</th> <th>Interleaving length</th> <th>Number of blocks</th> <th><math>L_f</math></th> <th>BUFS</th> <th>Design Delay</th> <th>OK or NOK</th> </tr> </thead> <tbody> <tr> <td>0</td> <td>3</td> <td>200</td> <td>60</td> <td>1613824</td> <td>669553</td> <td></td> </tr> <tr> <td>0</td> <td>1</td> <td>68</td> <td>22</td> <td>1613824</td> <td>737040</td> <td></td> </tr> <tr> <td>1</td> <td>2</td> <td>68</td> <td>12</td> <td>1613824</td> <td>805229</td> <td></td> </tr> </tbody> </table>	Interleaving type	Interleaving length	Number of blocks	$L_f$	BUFS	Design Delay	OK or NOK	0	3	200	60	1613824	669553		0	1	68	22	1613824	737040		1	2	68	12	1613824	805229	
Interleaving type	Interleaving length	Number of blocks	$L_f$	BUFS	Design Delay	OK or NOK																							
0	3	200	60	1613824	669553																								
0	1	68	22	1613824	737040																								
1	2	68	12	1613824	805229																								
<b>Conformity</b>	<input type="checkbox"/> OK <input type="checkbox"/> Fault <input type="checkbox"/> Major <input type="checkbox"/> Minor, define fail reason in comments																												
<b>Comments</b>	<p>If possible describe if fault can be fixed with software update: <input type="checkbox"/> YES <input type="checkbox"/> NO</p> <p>Describe more specific faults and/or other information</p>																												
<b>Date</b>	<table border="1"> <tr> <td style="width: 50%;"></td> <td style="width: 50%;"><b>Sign</b></td> </tr> </table>		<b>Sign</b>																										
	<b>Sign</b>																												

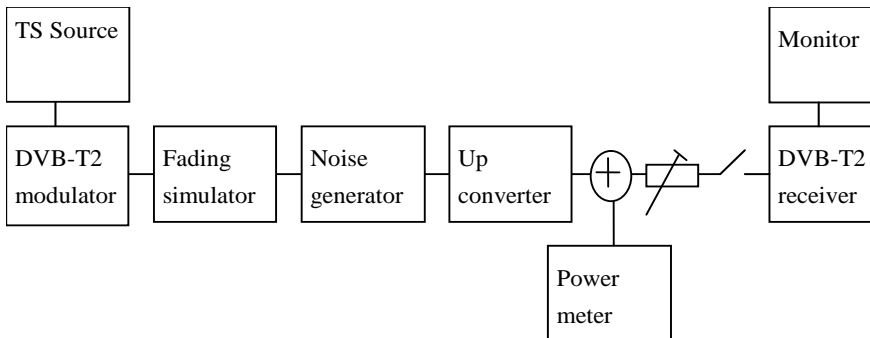
<b>Test Case</b>	<b>Task 3:54 DVB-T2: Input/Output Data Formats</b>										
<b>Section</b>	NorDig Unified 3.4.9										
<b>Requirement</b>	The NorDig IRD-T2 shall be able to support TS bit rates $\leq 72$ Mbit/s.										
<b>IRD Profile(s)</b>	Basic, IRD, DVB-T2										
<b>Test procedure</b>	<p><b>Purpose of test:</b> To verify maximum bit rate from DVB-T2 front end.</p> <p><b>Equipment:</b></p>  <pre> graph LR     TS[TS Source] --- M[DVB-T2 modulator]     M --- FS[Fading simulator]     FS --- NG[Noise generator]     NG --- UC[Up converter]     UC --- PM[Power meter]     PM --- DVB[DVB-T2 receiver]     DVB --- MON[Monitor]           </pre> <table border="1"> <tr> <td>Carrier mode</td> <td>Extended</td> </tr> <tr> <td>PAPR</td> <td>Off</td> </tr> <tr> <td>SISO/MISO</td> <td>SISO</td> </tr> <tr> <td>FEC Frame length</td> <td>64800</td> </tr> <tr> <td>Input mode</td> <td>Mode A</td> </tr> </table>	Carrier mode	Extended	PAPR	Off	SISO/MISO	SISO	FEC Frame length	64800	Input mode	Mode A
Carrier mode	Extended										
PAPR	Off										
SISO/MISO	SISO										
FEC Frame length	64800										
Input mode	Mode A										

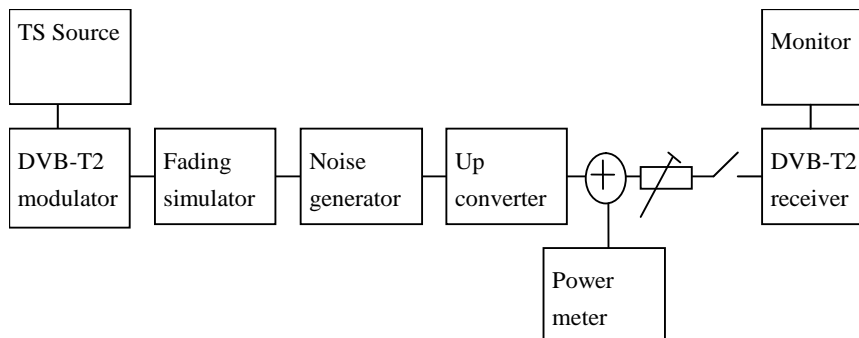

	TFS	No
	Mode	HEM (high efficiency mode)
	FEF	Not used
	Auxiliary streams	Not used
<b>Test procedure:</b>		
<ol style="list-style-type: none"> <li>Set up the test system</li> <li>Use DVB-T2 mode 32K extended, 256QAM rotated, PP7, R5/6, G1/128, 8MHz signal bandwidth on 666MHz</li> <li>Configure the interleaving type and length according to measurement record in test results.</li> </ol>		
<b>Expected result:</b>		
DVB-T2 front end is able to deliver transport streams up to bit rate supported by the DVB-T2 mode (approx 50Mbit/s).		
<b>Test result(s)</b>		
<b>Conformity</b>	<input type="checkbox"/> OK <input type="checkbox"/> Fault <input type="checkbox"/> Major <input type="checkbox"/> Minor, define fail reason in comments	
<b>Comments</b>	If possible describe if fault can be fixed with software update: <input type="checkbox"/> YES <input type="checkbox"/> NO Describe more specific faults and/or other information	
<b>Date</b>		<b>Sign</b>

<b>Test Case</b>	<b>Task 3:55 DVB-T2: Performance: BER vs C/N verification</b>
<b>Section</b>	NorDig Unified 3.4.10.2
<b>Requirement</b>	Verify the internal BER measurement of the NorDig IRD for objective measurements (QMP3).
<b>IRD Profile(s)</b>	Basic, IRD, DVB-T2
<b>Test procedure</b>	<p><b>Purpose of test:</b> To check that the internal BER value measured by the receiver displays correct values.</p> <p><b>Equipment:</b></p>  <pre> graph LR     TS[TS Source] --&gt; Mod[DVB-T2 modulator]     Mod --&gt; Fading[Fading simulator]     Fading --&gt; Noise[Noise generator]     Noise --&gt; Up[Up converter]     Up --&gt; PM((+))     PM --&gt; SW[Switch]     SW --&gt; Rec[DVB-T2 receiver]     Rec --&gt; Mon[Monitor]     </pre> <p><b>Test procedure:</b></p> <ol style="list-style-type: none"> <li>Setup the instruments.</li> <li>Use channel 45 and use Gaussian channel</li> </ol>

	<ol style="list-style-type: none"> <li>3. Use DVB-T2 mode 32k extended, 256QAM rotated, R2/3, G1/16, PP4, L1-ACE &amp; TR PAPR and signal bandwidth 8MHz.</li> <li>4. Set the RF input level to -50dBm.</li> <li>5. Starting from high C/N, decrease the C/N and fill in the corresponding BER after LDPC value measured by the receiver in measurement record.</li> <li>6. Adjust the C/N to a value which corresponds required C/N for QMP2 “30s subjective error free video”.</li> <li>7. Decrease C/N by 0.3dB</li> <li>8. Fill in the BER after LDPC in the measurement record.</li> </ol> <p><b>Expected result:</b></p> <p>The decrease of the required C/N for QMP2 “30s subjective error free video” or BER 1E-7 after LDPC by 0.3dB shall result approximately BER 1E-4 after LDPC.</p>																										
<b>Test result(s)</b>	<p>Measurement record:</p> <table border="1" style="margin-left: auto; margin-right: auto;"> <thead> <tr> <th>C/N</th> <th>Measured BER by the receiver</th> </tr> </thead> <tbody> <tr><td>18.6</td><td></td></tr> <tr><td>18.8</td><td></td></tr> <tr><td>19.0</td><td></td></tr> <tr><td>19.2</td><td></td></tr> <tr><td>19.4</td><td></td></tr> <tr><td>19.6</td><td></td></tr> <tr><td>19.8</td><td></td></tr> <tr><td>20.0</td><td></td></tr> <tr><td>20.2</td><td></td></tr> </tbody> </table> <table border="1" style="margin-left: auto; margin-right: auto;"> <thead> <tr> <th></th> <th>BER after LDPC</th> </tr> </thead> <tbody> <tr> <td>C/N@QMP2 „30s error free video“</td> <td></td> </tr> <tr> <td>C/N@QMP2 „30s error free video“ – 0.3dB</td> <td></td> </tr> </tbody> </table>	C/N	Measured BER by the receiver	18.6		18.8		19.0		19.2		19.4		19.6		19.8		20.0		20.2			BER after LDPC	C/N@QMP2 „30s error free video“		C/N@QMP2 „30s error free video“ – 0.3dB	
C/N	Measured BER by the receiver																										
18.6																											
18.8																											
19.0																											
19.2																											
19.4																											
19.6																											
19.8																											
20.0																											
20.2																											
	BER after LDPC																										
C/N@QMP2 „30s error free video“																											
C/N@QMP2 „30s error free video“ – 0.3dB																											
<b>Conformity</b>	<input type="checkbox"/> <b>OK</b> <input type="checkbox"/> <b>Fault</b> <input type="checkbox"/> Major <input type="checkbox"/> Minor, define fail reason in comments																										
<b>Comments</b>	<p>If possible describe if fault can be fixed with software update: <input type="checkbox"/> <b>YES</b> <input type="checkbox"/> <b>NO</b></p> <p>Describe more specific faults and/or other information</p>																										
<b>Date</b>	<b>Sign</b>																										

<b>Test Case</b>	<b>Task 3:56 DVB-T2: Performance: C/N performance on Gaussian channel</b>
<b>Section</b>	NorDig Unified 3.4.10.3
<b>Requirement</b>	The NorDig IRD shall have at least the QEF performance for the C/N ratios given in, Table 2.3 (PP2) and Table 2.6 (PP7) Maximum required C/N for profiles 1 and 2.
<b>IRD Profile(s)</b>	Basic, IRD, DVB-T2
<b>Test procedure</b>	<p><b>Purpose of test:</b></p> <p>To test the required C/N for quasi error free reception in Gaussian channel.</p> <p><b>Equipment:</b></p>

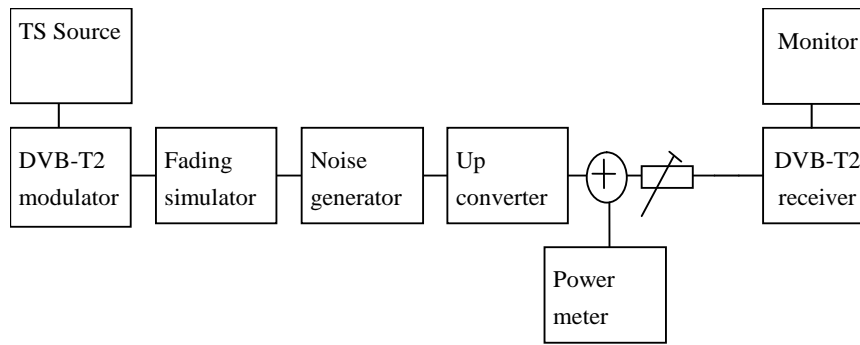

Use Mode A (Single PLP) and following deviations to parameter settings defined in 2.3.7 Summary of DVB-T2 modes in DVB-T2 test tasks:

Pilot pattern	PP7 (7MHz and 8MHz BW) PP2 (1.7MHz BW)
L1 post constellation	L1 post constellation must be more robust than data PLP constellation.

**Test procedure for Gaussian channel:**

1. Set up the test instruments
2. Use the following DVB-T2 mode {32k extended, 256QAM rotated, R2/3, GI1/128}
3. Set the up-converter to channel 21
4. Measure the input level to the attenuator.
5. Determine the attenuation of the attenuator and the cables.
6. Calculate the receiver input signal level and set it to -50dBm.
7. Use the value for the required C/N specified for the DVB-T2 mode in Table 2.3.
8. Do the channel search.
9. Increase the C/N from low value to higher value until the quality measurement procedure 2 (QMP2) fulfils.
10. Fill in the measured value in dB in the measurement record.
11. Repeat the test for the rest of the frequencies, signal bandwidths and DVB-T2 modes defined in the measurement record.

**Expected result:**

The required C/N for quasi error free reception in Gaussian channel is less than specified in Table 2.6.  
If 1.7MHz signal BW is supported, the required C/N for quasi error free reception in Gaussian channel is less than specified in Table 2.3.

<i>Test result(s)</i>	Measurement record: See tables below.
<i>Conformity</i>	<input type="checkbox"/> OK <input type="checkbox"/> Fault <input type="checkbox"/> Major <input type="checkbox"/> Minor, define fail reason in comments
<i>Comments</i>	If possible describe if fault can be fixed with software update: <input type="checkbox"/> YES <input type="checkbox"/> NO Describe more specific faults and/or other information
<i>Date</i>	<i>Sign</i>

Measurement record:

FFT Signal bandwidth	32k normal 7 MHz			32k extended 8 MHz								
Center frequency [MHz]	177.5	198.5	226.5	474.0	522.0	570.0	618.0	666.0	714.0	762.0	810.0	858.0
DVB-T2 mode / Channel Id	K5	K8	K12	K21	K27	K33	K39	K45	K51	K57	K63	K69
QPSK R1/2 G1/128												
QPSK R3/5 G1/128												
QPSK R2/3 G1/128												
QPSK R3/4 G1/128												
QPSK R4/5 G1/128												
QPSK R5/6 G1/128												
16QAM R1/2 G1/128												
16QAM R3/5 G1/128												
16QAM R2/3 G1/128												
16QAM R3/4 G1/128												
16QAM R4/5 G1/128												
16QAM R5/6 G1/128												
64QAM R1/2 G1/128												
64QAM R3/5 G1/128												
64QAM R2/3 G1/128												
64QAM R3/4 G1/128												
64QAM R4/5 G1/128												
64QAM R5/6 G1/128												
256QAM R1/2 G1/128												
256QAM R3/5 G1/128												
256QAM R2/3 G1/128												
256QAM R3/4 G1/128												
256QAM R4/5 G1/128												
256QAM R5/6 G1/128												

Table 1. Mandatory frequencies and signal bandwidths to support.

FFT Signal bandwidth	8k normal 1.7 MHz	32k normal 8 MHz														
Center frequency [MHz]	206.352	114.0	114.5	170.0	170.5	177.5	178.0	226.0	226.5	233.5	234.0	296.5	298.0	306.0	386.0	466.0
DVB-T2 mode / Channel Id	9C	D1	S2	D8	S10	K5	D9	D15	K12	S11	D16	S20	D24	S21	S31	S41
256QAM R2/3 G1/8																
256QAM R2/3 G1/128																

Table 2. Optional frequencies and signal bandwidths to support.

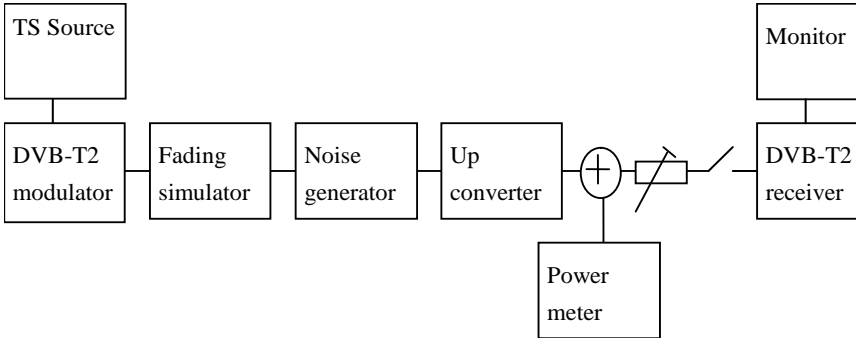
<b>Test Case</b>	<b>Task 3:57 DVB-T2: Performance: C/N performance on 0dB echo channel</b>
<b>Section</b>	NorDig Unified 3.4.10.3
<b>Requirement</b>	The NorDig IRD shall have at least the QEF performance for the C/N ratios given in, Table 2.3 (PP2) and Table 2.4 (PP4) Maximum required C/N for profiles 1 and 2.
<b>IRD Profile(s)</b>	Basic, IRD, DVB-T2
<b>Test procedure</b>	<p><b>Purpose of test:</b> To test the required C/N for quasi error free reception in 0 dB echo channel.</p> <p><b>Equipment:</b></p>  <pre> graph LR     TS[TS Source] --&gt; Mod[DVB-T2 modulator]     Mod --&gt; Fading[Fading simulator]     Fading --&gt; Noise[Noise generator]     Noise --&gt; Up[Up converter]     Up --&gt; Circulator((+))     Circulator --&gt; PM[Power meter]     Circulator --&gt; Rec[DVB-T2 receiver]     Rec --&gt; Mon[Monitor]     </pre> <p>The 0 degree channel center shall be used in fading simulator (see 2.3.50dB echo).</p> <p>Use Mode A (Single PLP) parameter settings defined in 2.3.7Summary of DVB-T2 modes in DVB-T2 test tasks.</p> <p><b>Test procedure for 0 dB echo channel:</b></p> <p>Check the different SFN synchronization issues from 2.3.4 Receiver operability in SFN.</p> <ol style="list-style-type: none"> <li>1. Set up the test instruments</li> <li>2. Use the following DVB-T2 mode {32K extended, 256QAM, PP7, R2/3, G1/128} and signal bandwidth 8MHz.</li> <li>3. Set the up-converter to frequency 666MHz (K45)</li> <li>4. Set the fading simulator to 0dB echo profile. (Delay 1.95us, 0 degree phase at channel center and attenuation 0dB for the second path.)</li> <li>5. Measure the input level to the attenuator.</li> <li>6. Determine the attenuation of the attenuator and the cables.</li> <li>7. Calculate the receiver input signal level and set it to -50dBm.</li> <li>8. Increase the C/N from low value to higher value until the quality measurement procedure 2 (QMP2) is fulfilled.</li> <li>9. Fill in the measured C/N value in dB in the measurement record.</li> <li>10. Verify also that the channel search finds the services at the measured C/N.</li> <li>11. Repeat the test for rest of the DVB-T2 modes combinations with 8MHz signal bandwidth in measurement record.</li> <li>12. Set the up-converter to frequency 198.5MHz (K8) and verify the input level into the receiver is -50dBm.</li> <li>13. Repeat the test for rest of the DVB-T2 mode combinations with 7MHz signal bandwidth in measurement record.</li> </ol> <p><b>Expected result:</b> The required C/N for quasi error free reception in 0 dB echo channel is less than specified in Table 2.3 and Table 2.4 except for DVB-T2 mode 32KE 256QAMR R3/4</p>

	G1/32 8MHz PP6. If 1.7MHz signal BW is supported, the required C/N for quasi error free reception in Gaussian channel is less than specified in Table 2.3.																																												
<b>Test result(s)</b>	<p>Measurement record:</p> <table border="1" style="margin-left: auto; margin-right: auto;"> <thead> <tr> <th rowspan="2">DVB-T2 mode</th> <th colspan="4">C/N [dB]</th> </tr> <tr> <th>PP2</th> <th>PP4</th> <th>PP6</th> <th>PP7</th> </tr> </thead> <tbody> <tr> <td>32KE 256QAMR R3/4 G1/8 8MHz</td> <td></td> <td>N/A</td> <td>N/A</td> <td>N/A</td> </tr> <tr> <td>32KN 256QAMR R3/4 G1/8 7MHz</td> <td></td> <td>N/A</td> <td>N/A</td> <td>N/A</td> </tr> <tr> <td>32KE 256QAMR R3/4 G1/16 8MHz</td> <td style="background-color: #cccccc;"></td> <td></td> <td>N/A</td> <td>N/A</td> </tr> <tr> <td>32KN 256QAMR R3/4 G1/16 7MHz</td> <td style="background-color: #cccccc;"></td> <td></td> <td>N/A</td> <td>N/A</td> </tr> <tr> <td>32KE 256QAMR R3/4 G1/32 8MHz <sup>1)</sup></td> <td>N/A</td> <td style="background-color: #cccccc;"></td> <td></td> <td>N/A</td> </tr> <tr> <td>32KE 256QAMR R3/4 G1/128 8MHz</td> <td>N/A</td> <td>N/A</td> <td>N/A</td> <td></td> </tr> <tr> <td>32KN 256QAMR R3/4 G1/128 7MHz</td> <td>N/A</td> <td>N/A</td> <td>N/A</td> <td></td> </tr> </tbody> </table> <p>Table 1. Mandatory test for required C/N for 0dB 1.95µs echo.</p> <p>1) This mode is not required in NorDig performance requirements, but added here in order to compare between different pilot patterns.</p>	DVB-T2 mode	C/N [dB]				PP2	PP4	PP6	PP7	32KE 256QAMR R3/4 G1/8 8MHz		N/A	N/A	N/A	32KN 256QAMR R3/4 G1/8 7MHz		N/A	N/A	N/A	32KE 256QAMR R3/4 G1/16 8MHz			N/A	N/A	32KN 256QAMR R3/4 G1/16 7MHz			N/A	N/A	32KE 256QAMR R3/4 G1/32 8MHz <sup>1)</sup>	N/A			N/A	32KE 256QAMR R3/4 G1/128 8MHz	N/A	N/A	N/A		32KN 256QAMR R3/4 G1/128 7MHz	N/A	N/A	N/A	
DVB-T2 mode	C/N [dB]																																												
	PP2	PP4	PP6	PP7																																									
32KE 256QAMR R3/4 G1/8 8MHz		N/A	N/A	N/A																																									
32KN 256QAMR R3/4 G1/8 7MHz		N/A	N/A	N/A																																									
32KE 256QAMR R3/4 G1/16 8MHz			N/A	N/A																																									
32KN 256QAMR R3/4 G1/16 7MHz			N/A	N/A																																									
32KE 256QAMR R3/4 G1/32 8MHz <sup>1)</sup>	N/A			N/A																																									
32KE 256QAMR R3/4 G1/128 8MHz	N/A	N/A	N/A																																										
32KN 256QAMR R3/4 G1/128 7MHz	N/A	N/A	N/A																																										
<b>Conformity</b>	<input type="checkbox"/> <b>OK Fault</b> <input type="checkbox"/> Major <input type="checkbox"/> Minor, define fail reason in comments																																												
<b>Comments</b>	If possible describe if fault can be fixed with software update: <input type="checkbox"/> <b>YES</b> <input type="checkbox"/> <b>NO</b> Describe more specific faults and/or other information																																												
<b>Date</b>	<b>Sign</b>																																												

<b>Test Case</b>	<b>Task 3:58 DVB-T2: Performance: Minimum receiver signal input levels on Gaussian channel</b>
<b>Section</b>	NorDig Unified 3.4.10.4
<b>Requirement</b>	<p>The NorDig IRD shall provide QEF reception for the minimum signal levels (<math>P_{min}</math>) for the supported frequency range as stated below (at 290K).</p> <p>For 7 MHz Normal Bandwidth DVB-T/T2 signal: <math>P_{min} = -105.7 \text{ dBm} + \text{NF [dB]} + \text{C/N [dB]}</math>, and  For 8 MHz Normal Bandwidth DVB-T/T2 signal: <math>P_{min} = -105.2 \text{ dBm} + \text{NF [dB]} + \text{C/N [dB]}</math>, and  For 1.7 MHz Normal Bandwidth DVB-T2 signal: <math>P_{min} = -112.1 \text{ dBm} + \text{NF [dB]} + \text{C/N [dB]}</math>, and  For 7 MHz Extended Bandwidth DVB-T2 signal: <math>P_{min} = -105.7 \text{ dBm} + \text{NF [dB]} + \text{C/N [dB]}</math>, and  For 8 MHz Extended Bandwidth DVB-T2 signal: <math>P_{min} = -105.1 \text{ dBm} + \text{NF [dB]} + \text{C/N [dB]}</math>, and  For 1.7 MHz Extended Bandwidth DVB-T2 signal: <math>P_{min} = -112.1 \text{ dBm} + \text{NF [dB]} + \text{C/N [dB]}</math>,</p> <p>C/N is specified in tables 3.7 and 3.8 (1) and NF is specified in tables 3.9 and 3.10 (1).</p>
<b>IRD Profile(s)</b>	Basic, IRD, DVB-T2
<b>Test procedure</b>	<b>Purpose of test:</b>

To verify the sensitivity of the receiver on Gaussian channel over the supported frequency range.

**Equipment:**

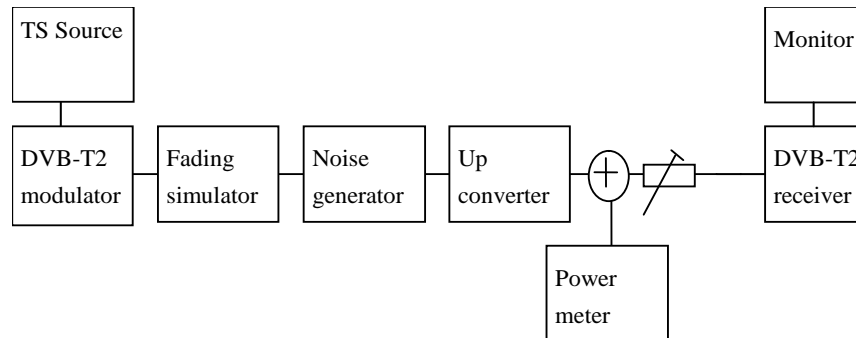

Be careful in impedance matching of cables, adapters and etc.

Use Mode A (Single PLP) and following deviations to parameter settings defined in 2.3.7 Summary of DVB-T2 modes in DVB-T2 test tasks.

Pilot pattern	PP7 (7MHz and 8MHz BW) PP2 (1.7MHz BW)
L1 post constellation	L1 post constellation must be more robust than data PLP constellation.

**Test procedure for the sensitivity on the gaussian channel:**

1. Set up the test instruments
2. Use the following DVB-T2 mode {32K extended, 256QAM, R2/3, GI1/128} and signal bandwidth 8MHz .
3. Set the up-converter to frequency 474MHz (K21).
4. Measure the input level to the attenuator.
5. Determine the attenuation of the attenuator and the cables.
6. Calculate the receiver input signal.
7. Do the channel search.
8. Increase the received input level from low value to higher value until the quality measurement procedure 2 (QMP2) is fulfilled.
9. Fill in the measured value in the measurement record.
10. Repeat the test for the rest of the frequencies, DVB-T2 modes and signal bandwidths on measurement record.

**Expected result:**

Sensitivity shall be equal or better for all measured frequencies (channels) and for all DVB-T2 modes and signal bandwidths as specified in Table 2.10.

If signal bandwidth 1.7MHz is supported, the sensitivity shall be equal or better for measured frequency and for DVB-T2 mode as specified in Table 2.7.

<b>Test result(s)</b>	Measurement record: See following page.
<b>Conformity</b>	<input type="checkbox"/> OK Fault <input type="checkbox"/> Major <input type="checkbox"/> Minor, define fail reason in comments
<b>Comments</b>	If possible describe if fault can be fixed with software update: <input type="checkbox"/> YES <input type="checkbox"/> NO Describe more specific faults and/or other information
<b>Date</b>	<b>Sign</b>

Measurement record:

FFT Signal bandwidth	32k normal 7 MHz			32k extended 8 MHz								
	Center frequency [MHz]	177.5	198.5	226.5	474.0	522.0	570.0	618.0	666.0	714.0	762.0	810.0
DVB-T2 mode / Channel Id	K5	K8	K12	K21	K27	K33	K39	K45	K51	K57	K63	K69
QPSK R1/2 G1/128												
QPSK R3/5 G1/128												
QPSK R2/3 G1/128												
QPSK R3/4 G1/128												
QPSK R4/5 G1/128												
QPSK R5/6 G1/128												
16QAM R1/2 G1/128												
16QAM R3/5 G1/128												
16QAM R2/3 G1/128												
16QAM R3/4 G1/128												
16QAM R4/5 G1/128												
16QAM R5/6 G1/128												
64QAM R1/2 G1/128												
64QAM R3/5 G1/128												
64QAM R2/3 G1/128												
64QAM R3/4 G1/128												
64QAM R4/5 G1/128												
64QAM R5/6 G1/128												
256QAM R1/2 G1/128												
256QAM R3/5 G1/128												
256QAM R2/3 G1/128												
256QAM R3/4 G1/128												
256QAM R4/5 G1/128												
256QAM R5/6 G1/128												

Table 1. Mandatory frequencies and signal bandwidths to support.

FFT Signal bandwidth	8k normal 1.7 MHz	32k normal 8 MHz														
		Center frequency [MHz]	206.352	114.0	114.5	170.0	170.5	177.5	178.0	226.0	226.5	233.5	234.0	296.5	298.0	306.0
DVB-T2 mode / Channel Id	9C	D1	S2	D8	S10	K5	D9	D15	K12	S11	D16	S20	D24	S21	S31	S41
256QAM R2/3 G1/8																
256QAM R2/3 G1/128																

Table 2. Optional frequencies and signal bandwidths to support.

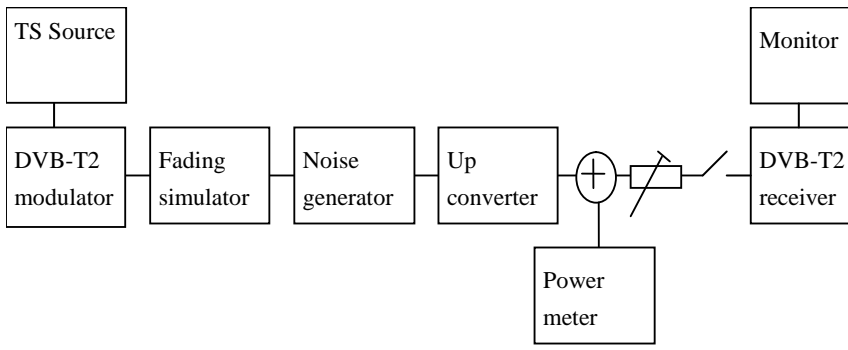

<b>Test Case</b>	<b>Task 3:59 DVB-T2: Performance: Minimum IRD Signal Input Levels on 0dB echo channel</b>
<b>Section</b>	NorDig Unified 3.4.10.4
<b>Requirement</b>	<p>The NorDig IRD shall provide QEF reception for the minimum signal levels (<math>P_{min}</math>) for the supported frequency range as stated below (at 290K).</p> <p>For 7 MHz Normal Bandwidth DVB-T/T2 signal: <math>P_{min} = -105.7 \text{ dBm} + \text{NF} [\text{dB}] + C/N [\text{dB}]</math>, and</p> <p>For 8 MHz Normal Bandwidth DVB-T/T2 signal: <math>P_{min} = -105.2 \text{ dBm} + \text{NF} [\text{dB}] + C/N [\text{dB}]</math>, and</p> <p>For 1.7 MHz Normal Bandwidth DVB-T2 signal: <math>P_{min} = -112.1 \text{ dBm} + \text{NF} [\text{dB}] + C/N [\text{dB}]</math>, and</p> <p>For 7 MHz Extended Bandwidth DVB-T2 signal: <math>P_{min} = -105.7 \text{ dBm} + \text{NF} [\text{dB}] + C/N [\text{dB}]</math>, and</p> <p>For 8 MHz Extended Bandwidth DVB-T2 signal: <math>P_{min} = -105.1 \text{ dBm} + \text{NF} [\text{dB}] + C/N [\text{dB}]</math>, and</p> <p>For 1.7 MHz Extended Bandwidth DVB-T2 signal: <math>P_{min} = -112.1 \text{ dBm} + \text{NF} [\text{dB}] + C/N [\text{dB}]</math>,</p>
<b>IRD Profile(s)</b>	Basic, IRD, DVB-T2
<b>Test procedure</b>	<p><b>Purpose of test:</b> To verify the sensitivity of the receiver on frequency selective channel.</p> <p><b>Equipment:</b></p>  <pre> graph LR     TS[TS Source] --&gt; Mod[DVB-T2 modulator]     Mod --&gt; Fading[Fading simulator]     Fading --&gt; Noise[Noise generator]     Noise --&gt; Up[Up converter]     Up --&gt; Receiver[DVB-T2 receiver]     Up --- PM[Power meter]     Receiver --- Mon[Monitor]     </pre> <p>The 0 degree channel center shall be used in fading simulator (see 2.3.4) 0dB echo.</p> <p>Be careful in impedance matching of cables, adapters and etc.</p> <p>The 0dB echo profile must be activated when measuring the power level of the signal.</p> <p>Use Mode A (Single PLP) parameter settings defined in 2.3.7 Summary of DVB-T2 modes in DVB-T2 test tasks.</p> <p><b>Test procedure for the sensitivity on the frequency selective channel:</b></p> <p>Check the different SFN synchronisation issues from 2.3.4 Receiver operability in SFN.</p> <ol style="list-style-type: none"> <li>1. Set up the test instruments</li> <li>2. Use the following DVB-T2 mode {32K extended, 256QAM, PP7, R2/3, GI1/128} and signal bandwidth 8MHz.</li> <li>3. Set the up-converter to frequency 666.0 MHz (K45).</li> <li>4. Set the fading simulator to 0dB echo profile. (Delay 1.95us, 0 degree phase at</li> </ol>

- channel center and attenuation 0dB for the second path.)
5. Determine the attenuation of the attenuator and the cables.
  6. Measure the input level to the attenuator.
  7. Calculate the receiver input signal level.
  8. Increase the received input level from low value to higher value until the quality measurement procedure 2 (QMP2) is fulfilled.
  9. Fill in the measured value in the measurement record.
  10. Verify that the channel search finds the services on measured minimum input signal level.
  11. Repeat the test for the rest of the DVB-T2 modes with signal bandwidth of 8MHz and 7MHz on the measurement record. DVB-T2 modes with 7MHz signal bandwidth are tested on center frequency 198.5MHz (K8).
  12. Optionally, repeat the test for the rest of the DVB-T2 modes with signal bandwidth of 1.7MHz on the measurement record. DVB-T2 mode with 1.7MHz signal bandwidth is tested on center frequency 206.352 MHz (9C).

**Expected result:**

Required minimum signal level shall be equal or lower in dBm than specified in Table 2.7, Table 2.8, Table 2.9 and Table 2.10 on measured frequencies, DVB-T2 modes and signal bandwidths for all echo delays.  
 If signal bandwidth 1.7MHz is supported, the required minimum signal level shall be equal or lower in dBm than specified in table 2.6 on measured frequency and for DVB-T2 mode.

**Test result(s)**

Measurement record:

DVB-T2 mode / 0dB echo [μs]	P [dBm]											
	10	26	112.1	133	152	212	224	253	256	289	426	486
32KE 256QAM PP7 R2/3 G1/128 8MHz												
32KE 256QAM PP4 R2/3 G1/16 8MHz												
32KE 256QAM PP4 R3/5 G19/256 8MHz												
32KN 256QAM PP4 R2/3 G19/256 7MHz												
32KE 256QAM PP2 R3/4 G1/8 8MHz												
32KN 256QAM PP2 R3/4 G1/8 7MHz												

Table 1. Mandatory frequencies and signal bandwidths to support.

DVB-T2 mode / 0dB echo [μs]	dBm		
	10	263	527
8KN 256QAMR PP2 R2/3 G1/8 1.7MHz			

Table 2. Optional frequencies and signal bandwidths to support.



<b>Conformity</b>	<input type="checkbox"/> OK Fault <input type="checkbox"/> Major <input type="checkbox"/> Minor, define fail reason in comments		
<b>Comments</b>	If possible describe if fault can be fixed with software update: <input type="checkbox"/> YES <input type="checkbox"/> NO Describe more specific faults and/or other information		
<b>Date</b>		<b>Sign</b>	

<b>Test Case</b>	<b>Task 3:60 DVB-T2: Performance: Receiver noise figure on Gaussian channel</b>																						
<b>Section</b>	NorDig Unified 3.4.10.4																						
<b>Requirement</b>	The NorDig IRD shall have a noise figure (NF) for supported frequency ranges equal or better than the values specified in Table 3.12.																						
<b>IRD Profile(s)</b>	Basic, IRD, DVB-T2																						
<b>Test procedure</b>	<p><b>Purpose of test:</b> To calculate the noise figure of the receiver for gaussian channel.</p> <p><b>Equipment:</b> No equipment needed.</p> <p><b>Test procedure for evaluation of the receiver noise figure:</b></p> <p>Determine the minimum carrier levels <math>C_{min}</math> for the gaussian channel measured in Task 3:59 (DVB-T2: Performance - Minimum IRD Signal Input Levels on Gaussian channel).</p> <p>Determine the required <math>C/N_{min}</math> for the gaussian channel measured in Task 3:57 (DVB-T2: Performance - C/N performance on Gaussian channel).</p> <p>Calculate the noise figure NF[dB] for the supported frequencies using the formulas</p> <p>For 8MHz extended DVB-T2 signal: <math>NF[dB] = N + 105.1dBm = C_{min} - C/N_{min} + 105.1dBm</math></p> <p>For 8MHz normal DVB-T2 signal: <math>NF[dB] = N + 105.2dBm = C_{min} - C/N_{min} + 105.2dBm</math></p> <p>For 7MHz normal DVB-T2 signal: <math>NF[dB] = N + 105.7dBm = C_{min} - C/N_{min} + 105.7dBm</math></p> <p>For 1.7MHz normal DVB-T2 signal: <math>NF[dB] = N + 112.1dBm = C_{min} - C/N_{min} + 105.7dBm</math></p> <p><b>Expected result:</b> The noise figure is less than or equal to table 3.12.</p>																						
<b>Test result(s)</b>	<p>Measurement record:</p> <table border="1"> <tr> <td>Frequency</td> <td>177.5</td> <td>198.5</td> <td>226.5</td> </tr> <tr> <td>Channel id</td> <td>K5</td> <td>K8</td> <td>K12</td> </tr> <tr> <td>FFTSIGNAL bandwidth</td> <td colspan="3">32k normal 7MHz</td> </tr> <tr> <td>Mode</td> <td colspan="3">NF [dB]</td> </tr> <tr> <td>256QAM R3/5</td> <td></td> <td></td> <td></td> </tr> </table>			Frequency	177.5	198.5	226.5	Channel id	K5	K8	K12	FFTSIGNAL bandwidth	32k normal 7MHz			Mode	NF [dB]			256QAM R3/5			
Frequency	177.5	198.5	226.5																				
Channel id	K5	K8	K12																				
FFTSIGNAL bandwidth	32k normal 7MHz																						
Mode	NF [dB]																						
256QAM R3/5																							

	256QAM R2/3								
Frequency	474.0	522.0	570.0	618.0	666.0	714.0	762.0	810.0	858.0
Channel id	K21	K27	K33	K39	K45	K51	K57	K63	K69
FFT Signal bandwidth	32k extended 8MHz								
Mode	NF [dB]								
256QAM R3/5									
256QAM R2/3									
Table 1. Mandatory frequencies and signal bandwidths to support.									
Frequency	206.352								
Channel id	9C								
FFT Signal bandwidth	8k normal 1.7MHz								
Mode	NF [dB]								
256QAM R2/3									
Frequency	114.0	114.5	170.0	170.5	177.5	178.0	226.0	226.5	
Channel id	D1	S2	D8	S10	K5	D9	D15	K12	
FFT Signal bandwidth	32k normal 8MHz								
Mode	NF [dB]								
256QAM R2/3									
Frequency	233.5	234.0	296.5	298.0	306.0	386.0	466.0		
Channel id	S11	D16	S20	D24	S21	S31	S41		
FFT Signal bandwidth	32k normal 8MHz								
Mode	NF [dB]								
256QAM R2/3									
Table 2. Optional frequencies and signal bandwidths to support.									
<b>Conformity</b>	<input type="checkbox"/> OK Fault <input type="checkbox"/> Major <input type="checkbox"/> Minor, define fail reason in comments								
<b>Comments</b>	If possible describe if fault can be fixed with software update: <input type="checkbox"/> YES <input type="checkbox"/> NO Describe more specific faults and/or other information								
<b>Date</b>						<b>Sign</b>			

<b>Test Case</b>	<b>Task 3:61 DVB-T2: Performance: Maximum Receiver Signal Input Levels</b>
<b>Section</b>	NorDig Unified 3.4.10.5 and 3.4.10.6
<b>Requirement</b>	The NorDig IRD shall provide QEF reception for DVB-T and DVB-T2 signals up to a level of -35dBm. The maximum analogue TV signal input level is restricted to -20 dBm defined as the r.m.s (root mean square) value of the vision carrier at peaks of the modulated envelope. The DVB-T signal input level is valid for the modes {8K, 64-QAM, R=2/3, Δ/Tu=1/8},

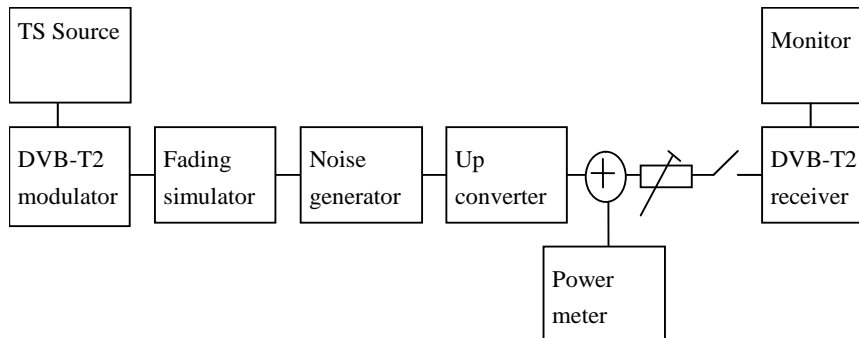
	<p>{8K, 64-QAM, R=2/3, <math>\Delta/T_u = 1/4</math>} and {8K, 64-QAM, R=3/4, <math>\Delta/T_u = 1/4</math>}.</p> <p>The DVB-T2 signal input level is valid for the modes shown in NorDig Specification (1).</p>						
<p><b>IRD Profile(s)</b></p>	<p>Basic, IRD, DVB-T2</p>						
<p><b>Test procedure</b></p>	<p><b>Purpose of test:</b></p> <p>To test that the receiver is able to handle high RF signals.</p> <p><b>Equipment:</b></p>  <p>Use Mode A (Single PLP) parameter settings defined in 2.3.7 Summary of DVB-T2 modes in DVB-T2 test tasks.</p> <p><b>Test procedure</b></p> <ol style="list-style-type: none"> <li>1. Set up the test instruments.</li> <li>2. Determine the attenuation of the attenuator.</li> <li>3. Use the following mode {32K extended, 256-QAM rotated, PP7, R=3/4, <math>\Delta/T_u = 1/128</math>}.</li> <li>4. Set the up-converter to channel 45.</li> <li>5. Determine the attenuation of the attenuator and the cables.</li> <li>6. Turn on the receiver.</li> <li>7. Check that the picture is decoded correctly.</li> <li>8. Calculate the receiver input signal level as a function of attenuation in attenuator.</li> <li>9. Increase the receiver input signal level until the quality measurement procedure 1 (QMP1) is fulfilled.</li> <li>10. Fill in the result in the measurement record.</li> </ol> <p><b>Expected result:</b></p> <p>The reception shall be QEF for input level higher than or equal to <math>-35\text{dBm}</math> for defined DVB-T2 modes.</p>						
<p><b>Test result(s)</b></p>	<p>Measurement record:</p> <table border="1" data-bbox="391 1814 1268 2004"> <thead> <tr> <th>Mode</th> <th>Requirement dBm</th> <th>Result</th> </tr> </thead> <tbody> <tr> <td>32K extended, 256-QAM rotated, PP7, R=3/4, <math>\Delta/T_u = 1/128</math></td> <td>-35</td> <td></td> </tr> </tbody> </table>	Mode	Requirement dBm	Result	32K extended, 256-QAM rotated, PP7, R=3/4, $\Delta/T_u = 1/128$	-35	
Mode	Requirement dBm	Result					
32K extended, 256-QAM rotated, PP7, R=3/4, $\Delta/T_u = 1/128$	-35						

<b>Conformity</b>	<input type="checkbox"/> OK Fault <input type="checkbox"/> Major <input type="checkbox"/> Minor, define fail reason in comments	
<b>Comments</b>	If possible describe if fault can be fixed with software update: <input type="checkbox"/> YES <input type="checkbox"/> NO Describe more specific faults and/or other information	
<b>Date</b>		<b>Sign</b>

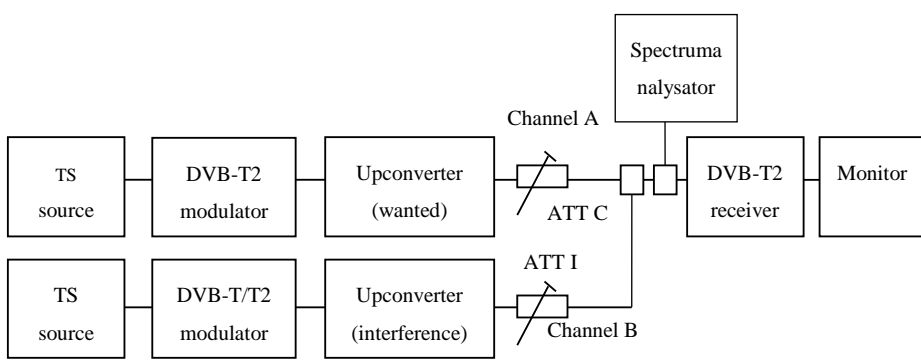
<b>Test Case</b>	<b>Task 3:62 DVB-T2: Performance: Immunity to “digital” signals in Other Channels</b>
<b>Section</b>	NorDig Unified 3.4.10.7.1
<b>Requirement</b>	<p>The NorDig IRD shall, for the supported frequency ranges, permit an interfering DVB-T or DVB-T2 signal with a minimum interference to signal level ratio (I/C) as stated in the NorDig Specification (1) while maintaining QEF reception.</p> <p>The requirements in this paragraph refer, for DVB-T, to the modes {8K, 64-QAM, R=2/3, Δ/Tu =1/8} and {8K, 64-QAM, R=2/3, Δ/Tu =1/4} and {8K, 64-QAM, R=3/4, Δ/Tu =1/4} and for DVB-T2 to the modes given in NorDig Specification.</p>
<b>IRD Profile(s)</b>	Basic, IRD, DVB-T2
<b>Test procedure</b>	<p><b>Purpose of test:</b> To verify the QEF reception for digital signal interference on adjacent or other channels.</p> <p><b>Equipment:</b></p>  <p>Verify that the digital signal on the adjacent or the other channels don't have too high shoulders, which could cause out-of-band emissions in the reception of the wanted digital TV signal.</p> <p>Worst case is when wanted and interference signals are DVB-T2 modulated in extended carrier mode in adjacent channels. This test can be performed using DVB-T modulated interferer, because the performance difference is expected to be negligible. When using DVB-T modulated interferer, signal bandwidth of the DVB-T modulated signal must be selected according to frequency range, except for the signal bandwidth 1.7MHz, which is not supported in the DVB-T system.</p> <p>Many of the European countries are going to free channel 61 and upwards to other types of services than TV. In this test a DVB-T interferer is used on channels over 60 in order to measure the interference from DVB-T system for comparison reasons.</p> <p>Use Mode A (Single PLP) parameter settings defined in 2.3.7 Summary of DVB-T2</p>

modes in DVB-T2 test tasks.

**Test procedure:**

1. Set up the test instruments
2. Use the following DVB-T2 mode {32K extended, 256-QAM rotated, PP4, R=3/4,  $\Delta/T_U=1/16$ } and signal bandwidth 8MHz.
3. Set the channel A up-converter to 666.0MHz (K45).
4. Set the channel B up-converter to 674.0MHz (K46).
5. Set the receiver input level for the DVB-T2 signal in channel B to -20 dBm.
6. Decrease the DVB-T2 signal level in channel A to a signal level when the quality measurement procedure 2 (QMP2) is still fulfilled.
7. Fill in the measured signal level difference between channel A and channel B signals in dB in measurement record.
8. Repeat the test when the channel B up-converter is set to frequencies 658.0 MHz (K44), 650.0 MHz (K43), 682.0 MHz (K47).
9. Repeat the test according to procedure above for the image channel<sup>1)</sup>. Set the receiver input level for the DVB-T2 signal in channel B to -20dBm.
10. Set the channel A up-converter to 786.0MHz (K60).
11. Set the channel B up-converter to 794.0MHz (K61).
12. Set the receiver input level for the DVB-T2 signal in channel B to -20 dBm.
13. Decrease the DVB-T2 signal level in channel A to a signal level when the quality measurement procedure 2 (QMP2) is still fulfilled.
14. Fill in the measured signal level difference between channel A and channel B signals in dB in measurement record.
15. Repeat the test when the channel B up-converter is set to frequencies 770.0 MHz (K58), 778.0 MHz (K59), 802.0 MHz (K62).
16. Repeat the test according to procedure above for the image channel<sup>1)</sup>. Set the receiver input level for the DVB-T2 signal in channel B to -20dBm.
17. Change the signal bandwidth to 7MHz.
18. Use the following DVB-T2 mode {32K normal, 256-QAM rotated, R=3/4, PP2,  $\Delta/T_U=1/8$ } and signal bandwidth 7MHz.
19. Set the channel A up-converter to frequency 198.5 MHz (K8).
20. Set the channel B up-converter to frequency 205.5 MHz (K9).
21. Set the receiver input level of the DVB-T2 signal in channel B to -20dBm.
22. Decrease the DVB-T2 signal level in channel A to a signal level when the quality measurement procedure 2 (QMP2) is fulfilled.
23. Fill in the measured signal level difference between channel A and channel B signals in dB in measurement record.
24. Repeat the test when the channel B up-converter is set to frequencies 191.5 MHz (K7), 184.5 MHz (K6) and 212.5 MHz (K10). If receiver supports optional frequency ranges and signal bandwidths, repeat the test for the optional frequencies and signal bandwidths.  
For 1.7MHz DVB-T2 signal use DVB-T2 mode {8K normal, 64QAM, R=2/3, PP2,  $\Delta/T_U=1/8$ } corresponding signal bandwidth 1.535 MHz.

<sup>1)</sup> Example: if intermediate frequency IF is 36.15MHz, the image channel is calculated for channel 45 as  $666\text{MHz} + 2 * 36.15\text{MHz} = 738.3\text{MHz}$  which is close to channel 54.

**Expected result:**

The wanted DVB-T2 signal shall be QEF for the interference signal levels specified for DVB-T2 modes, signal bandwidths and supported frequencies.

**Test result(s)**

Measurement record:

	7 MHz signal bandwidth			
Interferer center frequency [MHz]	184.5	191.5	205.5	212.5
DVB-T2 mode / Channel id	K6	K7	K9	K10
32K normal, 256-QAM rotated, PP2 R=3/4, $\Delta T_U = 1/8$				

Table 1. Mandatory VHF Band III frequencies and signal bandwidth to support

	8 MHz signal bandwidth				
Interferer center frequency [MHz]	650.0	658.0	674.0	682.0	738.0
DVB-T2 mode / Channel id	K43	K44	K46	K47	K54
32K extended, 256-QAM rotated, PP4, R=2/3, $\Delta T_U = 1/16$					

Table 2. Mandatory UHF Band IV/V frequencies and signal bandwidth to support

	8 MHz signal bandwidth				
Interferer center frequency [MHz]	770.0	778.0	794.0	802.0	810.0
DVB-T2 mode / Channel id	K58	K59	K61	K62	K63
32K extended, 256-QAM rotated, PP4, R=2/3, $\Delta T_U = 1/16$					

Table 3. Mandatory UHF Band IV/V frequencies and signal bandwidth to support

	7 MHz signal bandwidth			
Center frequency [MHz]	128.5	135.5	149.5	156.5
DVB-T2 mode / Channel id	S4	S5	S7	S8
32K normal, 256-QAM rotated, PP2, R=3/4, $\Delta T_U = 1/8$				

Table 4. Optional VHF S Band I frequencies and signal bandwidth to support

	8 MHz signal bandwidth			
Center frequency [MHz]	122.0	130.0	146.0	154.0
DVB-T2 mode / Channel id	D2	D3	D5	D6
32K extended, 256-QAM rotated, PP4, R=2/3, $\Delta T_U = 1/16$				

Table 5. Optional VHF S Band I frequencies and signal bandwidth to support

	8 MHz signal bandwidth			
Center frequency [MHz]	186.0	194.0	210.0	218.0
DVB-T2 mode / Channel id	D10	D11	D13	D14
32K extended, 256-QAM rotated, PP4				



R=2/3, $\Delta/T_U=1/16$				
-----------------------------	--	--	--	--

Table 6. Optional VHF Band III frequencies and signal bandwidth to support

	7 MHz signal bandwidth			
Center frequency [MHz]	247.5	254.5	268.5	275.5
DVB-T2 mode / Channel id	S13	S14	S16	S17
32K normal, 256-QAM rotated, PP2 R=3/4, $\Delta/T_U=1/8$				

Table 7. Optional VHF S Band II frequencies and signal bandwidth to support

	8 MHz signal bandwidth			
Center frequency [MHz]	250.0	258.0	274.0	282.0
DVB-T2 mode / Channel id	D18	D19	D21	D22
32K extended, 256-QAM rotated, PP4 R=2/3, $\Delta/T_U=1/16$				

Table 8. Optional VHF S Band II frequencies and signal bandwidth to support

	8 MHz signal bandwidth			
Center frequency [MHz]	370.0	378.0	394.0	402.0
DVB-T2 mode / Channel id	S29	S30	S32	S33
32K extended, 256-QAM rotated, PP4 R=2/3, $\Delta/T_U=1/16$				

Table 9. Optional UHF S Band III frequencies and signal bandwidth to support

	1.7 MHz signal bandwidth			
Center frequency [MHz]	202.928	204.640	208.064	209.936
DVB-T2 mode / Channel id	9A	9B	9D	10A
8K normal, 256-QAM rotated, PP2, R=2/3, $\Delta/T_U=1/8$				

Table 10. Optional VHF Band III frequencies and signal bandwidth to support

<b>Conformity</b>	<input type="checkbox"/> <b>OK</b> <input type="checkbox"/> <b>Fault</b> <input type="checkbox"/> Major <input type="checkbox"/> Minor, define fail reason in comments
<b>Comments</b>	If possible describe if fault can be fixed with software update: <input type="checkbox"/> <b>YES</b> <input type="checkbox"/> <b>NO</b> Describe more specific faults and/or other information
<b>Date</b>	<b>Sign</b>

<b>Test Case</b>	<b>Task 3:63 DVB-T2: Performance: Immunity to "LTE 700 MHz" signals in Other Channels</b>
<b>Section</b>	NorDig Unified 3.4.10.7.2

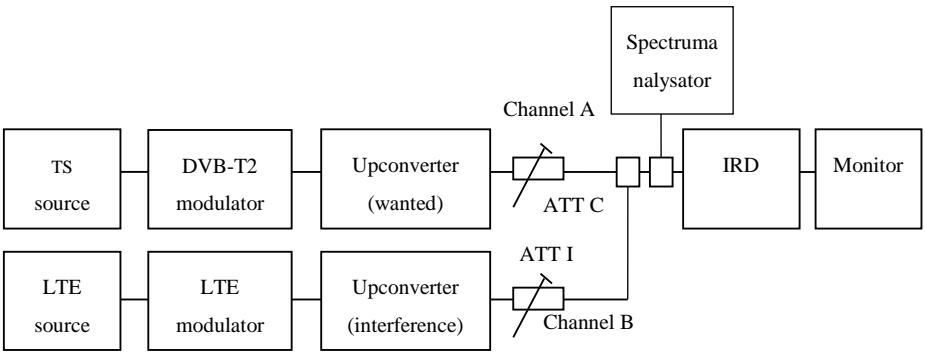
<p><b>Requirement</b></p>	<p>The terrestrial NorDig IRD and IRD-T2 shall, for the supported frequency ranges, permit an interfering 4G (LTE) “700MHz” signal with a minimum interference to signal level ratio (I/C) as stated in the Table 3.18 [1] while maintaining QEF reception.</p> <p>The power of the interfering LTE signal, both BS and UE, varies with a traffic load and traffic type. The signal power of the LTE signal is defined as the power during the active part of the time varying LTE signal, referred to as the licensed power level (I).</p> <p>The I/C values shall (1) be fulfilled for LTE signals with traffic loads from 0% to 100 % (BS) and for traffic loads from low bit rate to high bit rate (UE). Low traffic loads can be the most demanding ones. The minimum I/C requirement shall be fulfilled for interfering licensed power level signal levels in the range of -25 dBm in case of UE signals and -15dBm in case of BS signals defined as licensed power of interfering signal, at the input of the IRD.</p> <p>The requirements in this paragraph refer, for DVB-T, to following modes {FFT size, modulation, code rate, guard interval, bandwidth}; {8K, 64-QAM, R=2/3, Δ/Tu =1/8, 8MHz} and {8K, 64-QAM, R=2/3, Δ/Tu =1/4, 8MHz} and {8K, 64-QAM, R=3/4, Δ/Tu =1/4, 8MHz} and and for DVB-T2 to the modes {FFT size, modulation, pilot pattern, code rate, guard interval, bandwidth} {32KE, 256-QAM R, PP4, R=2/3, Δ/Tu =1/16, 8MHz} {32KE, 256-QAM R, PP4, R=3/5, Δ/Tu =19/256, 8MHz} {32KN, 256-QAM R, PP4, R=2/3, Δ/Tu =19/256, 7MHz}</p>
<p><b>IRD Profile(s)</b></p>	<p>Basic, IRD, DVB-T2</p>
<p><b>Test procedure</b></p>	<p><b>Purpose of test:</b> To verify the QEF reception for LTE 700 MHz signal interference on adjacent or other channels.</p> <p><b>Equipment:</b></p>  <p>Verify that the interfering LTE signal on the adjacent or the other channels don't have too high shoulders, which could cause out-of-band emissions in the reception of the wanted digital TV signal.</p> <p>From IRD point of view most demanding LTE signal might be that with low traffic load.</p> <p>The LTE transmission is generated by using following LTE signal characteristics: BS 0% traffic load (LTE_BS-idle_V3_synth.wv) UE Video stream traffic (short_UE-Video-Stream_V2.wv)</p> <p>Files in I/Q file format specified above are available on NorDig homepage.</p>

Use Mode A (Single PLP) and  $L_f$  parameter settings defined in Table 2.17.

**Test procedure:**

1. Set up the test instruments
2. Use the following DVB-T2 mode {32KE, 256-QAM R, PP4, R=2/3, G =1/16, 8MHz}
3. Set the channel A up-converter to 690.0MHz (K48).
4. Set the channel B up-converter to 708.0MHz .
5. Set the LTE interfeer to UE Video traffic mode.
6. Set the receiver input level for the LTE signal in channel B to -25 dBm.
7. Decrease the wanted signal level in channel A to a signal level when the quality measurement procedure 2 is still fulfilled.
8. Fill in the measured signal level difference between channel A and channel B signals in dB in measurement record.
9. Repeat the test when the channel B up-converter is set to frequencies 718.0 MHz, 728.0 MHz.
10. Set the channel B up-converter to 763.0MHz.
11. Set the LTE interfeer to BS 0% traffic load mode.
12. Set the receiver input level for the LTE signal in channel B to -15 dBm.
13. Decrease the wanted signal level in channel A to a signal level when the quality measurement procedure 2 is still fulfilled.
14. Fill in the measured signal level difference between channel A and channel B signals in dB in measurement record.
15. Repeat the test when the channel B up-converter is set to frequencies 773.0 MHz, 783.0 MHz.
16. Repeat the test for the DVB-T2 mode {32KE, 256-QAM R, PP4, R=3/5, G=19/256, 8MHz}.

**Expected result:**

The wanted DVB-T2 signal shall be QEF for the interference signal levels as specified.

**Test result(s)**

Measurement record:

Interferer centre frequency [MHz]	I/C [dB]		
	708.0	718.0	728.0
32KE, 256-QAM R, PP4, R=2/3, $\Delta/T_u = 1/16$ , 8MHz			
32KE, 256-QAM R, PP4, R=3/5, $\Delta/T_u = 19/256$ , 8MHz			

Table 1. UE Video stream traffic interferer

Interferer centre frequency [MHz]	I/C [dB]		
	763.0	773.0	783.0
32KE, 256-QAM R, PP4, R=2/3, $\Delta/T_u = 1/16$ , 8MHz			
32KE, 256-QAM R, PP4, R=3/5, $\Delta/T_u = 19/256$ , 8MHz			

Table 2. BS 0% traffic load interferer

**Conformity**

**OK Fault**  Major  Minor, define fail reason in comments

**Comments**

If possible describe if fault can be fixed with software update:  **YES**  **NO**  
Describe more specific faults and/or other information

**Date**

**Sign**

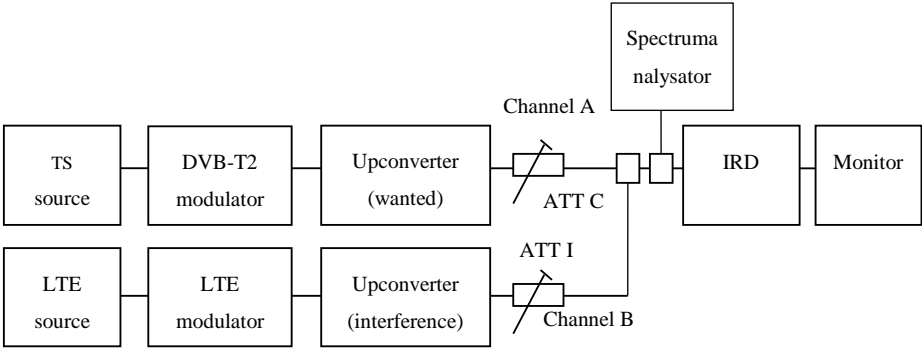
<b>Test Case</b>	<b>Task 3:64 DVB-T2: Performance: Immunity to “LTE 800 MHz” signals in Other Channels</b>
<b>Section</b>	NorDig Unified 3.4.10.7.1
<b>Requirement</b>	<p>The DVB-T and DVB-T2 IRD shall, for the supported frequency ranges, permit an interfering LTE signal with a minimum interference to signal level ratio (I/C) as stated in the table below while maintaining QEF reception.</p> <p>The power of the LTE signal, both BS and UE, varies with a traffic load. The signal power of the LTE signal is defined as the power during the active part of the time varying LTE signal. The I/C values shall be fulfilled for traffic loads 0% to 100 % (BS) and for traffic loads from low bit rate to high bit rate (UE). Low traffic loads can be the most demanding ones. The minimum I/C requirement shall be fulfilled for -15dBm defined as licensed power of interfering signal, at the input of the IRD.</p> <p>The requirements in this paragraph refer, for DVB-T, to the modes        {8K, 64-QAM, R=2/3, Δ/Tu =1/8, 8MHz} and        {8K, 64-QAM, R=2/3, Δ/Tu =1/4, 8MHz} and        {8K, 64-QAM, R=3/4, Δ/Tu =1/4, 8MHz} and        for DVB-T2 to the modes        {32KE, 256-QAM R, PP4, R=2/3, Δ/Tu =1/16, 8MHz}        {32KE, 256-QAM R, PP4, R=3/5, Δ/Tu =19/256, 8MHz}        {32KN, 256-QAM R, PP4, R=2/3, Δ/Tu =19/256, 7MHz}</p>
<b>IRD Profile(s)</b>	Basic, IRD, DVB-T2
<b>Test procedure</b>	<p><b>Purpose of test:</b> To verify the QEF reception for LTE signal interference on adjacent or other channels.</p> <p><b>Equipment:</b></p>  <p>Verify that the interfering LTE signal on the adjacent or the other channels don't have too high shoulders, which could cause out-of-band emissions in the reception of the wanted digital TV signal.</p> <p>From IRD point of view most demanding LTE signal might be that with low traffic load.</p> <p>The LTE transmission is generated by using following LTE signal characteristics:        LTE_BS-idle_V2.wv (BS 0% traffic load)        LTE_UE_1Mbs_V2.wv (UE 1 MBit/s traffic load)</p> <p>Files in I/Q file format are available on NorDig homepage.</p> <p>Use Mode A (Single PLP) and <math>L_f</math> parameter settings defined by Teracom for the modes.</p>

	<p><b>Test procedure:</b></p> <ol style="list-style-type: none"> <li>1. Set up the test instruments</li> <li>2. Use the following DVB-T mode {32KE, 256-QAM R, PP4, R=2/3, <math>\Delta/Tu = 1/16</math>, 8MHz}</li> <li>3. Set the channel A up-converter to 786.0MHz (K60).</li> <li>4. Set the channel B up-converter to 796.0MHz .</li> <li>5. Set the LTE interfere to BS 0% traffic load mode.</li> <li>6. Set the receiver input level for the LTE signal in channel B to -15 dBm.</li> <li>7. Decrease the wanted signal level in channel A to a signal level when the quality measurement procedure 2 is still fulfilled.</li> <li>8. Fill in the measured signal level difference between channel A and channel B signals in dB in measurement record.</li> <li>9. Repeat the test when the channel B up-converter is set to frequencies 806.0 MHz, 816.0 MHz.</li> <li>10. Set the channel B up-converter to 837.0MHz.</li> <li>11. Set the LTE interfere to UE 1 MBit/s traffic load mode.</li> <li>12. Set the receiver input level for the LTE signal in channel B to -15 dBm.</li> <li>13. Decrease the wanted signal level in channel A to a signal level when the quality measurement procedure 2 is still fulfilled.</li> <li>14. Fill in the measured signal level difference between channel A and channel B signals in dB in measurement record.</li> <li>15. Repeat the test when the channel B up-converter is set to frequencies 847.0 MHz, 857.0 MHz.</li> <li>16. Repeat the test for the DVB-T2 mode {32KE, 256-QAM R, PP4, R=3/5, <math>\Delta/Tu = 19/256</math>, 8MHz}.</li> </ol> <p><b>Expected result:</b></p> <p>The wanted DVB-T2 signal shall be QEF for the interference signal levels as specified.</p>																														
<b>Test result(s)</b>	<p>Measurement record:</p> <table border="1" style="width: 100%; border-collapse: collapse; margin-bottom: 10px;"> <thead> <tr> <th rowspan="2">Interferer centre frequency [MHz]</th> <th colspan="3">I/C [dB]</th> </tr> <tr> <th>796.0</th> <th>806.0</th> <th>816.0</th> </tr> </thead> <tbody> <tr> <td>32KE, 256-QAM R, PP4, R=2/3, <math>\Delta/Tu = 1/16</math>, 8MHz</td> <td></td> <td></td> <td></td> </tr> <tr> <td>32KE, 256-QAM R, PP4, R=3/5, <math>\Delta/Tu = 19/256</math>, 8MHz</td> <td></td> <td></td> <td></td> </tr> </tbody> </table> <p>Table 1. BS 0% interferer</p> <table border="1" style="width: 100%; border-collapse: collapse;"> <thead> <tr> <th rowspan="2">Interferer centre frequency [MHz]</th> <th colspan="3">I/C [dB]</th> </tr> <tr> <th>837.0</th> <th>847.0</th> <th>857.0</th> </tr> </thead> <tbody> <tr> <td>32KE, 256-QAM R, PP4, R=2/3, <math>\Delta/Tu = 1/16</math>, 8MHz</td> <td></td> <td></td> <td></td> </tr> <tr> <td>32KE, 256-QAM R, PP4, R=3/5, <math>\Delta/Tu = 19/256</math>, 8MHz</td> <td></td> <td></td> <td></td> </tr> </tbody> </table> <p>Table 2. UE 1 Mbit/s interferer</p>	Interferer centre frequency [MHz]	I/C [dB]			796.0	806.0	816.0	32KE, 256-QAM R, PP4, R=2/3, $\Delta/Tu = 1/16$ , 8MHz				32KE, 256-QAM R, PP4, R=3/5, $\Delta/Tu = 19/256$ , 8MHz				Interferer centre frequency [MHz]	I/C [dB]			837.0	847.0	857.0	32KE, 256-QAM R, PP4, R=2/3, $\Delta/Tu = 1/16$ , 8MHz				32KE, 256-QAM R, PP4, R=3/5, $\Delta/Tu = 19/256$ , 8MHz			
Interferer centre frequency [MHz]	I/C [dB]																														
	796.0	806.0	816.0																												
32KE, 256-QAM R, PP4, R=2/3, $\Delta/Tu = 1/16$ , 8MHz																															
32KE, 256-QAM R, PP4, R=3/5, $\Delta/Tu = 19/256$ , 8MHz																															
Interferer centre frequency [MHz]	I/C [dB]																														
	837.0	847.0	857.0																												
32KE, 256-QAM R, PP4, R=2/3, $\Delta/Tu = 1/16$ , 8MHz																															
32KE, 256-QAM R, PP4, R=3/5, $\Delta/Tu = 19/256$ , 8MHz																															
<b>Conformity</b>	<input type="checkbox"/> <b>OK Fault</b> <input type="checkbox"/> Major <input type="checkbox"/> Minor, define fail reason in comments																														
<b>Comments</b>	<p>If possible describe if fault can be fixed with software update: <input type="checkbox"/> <b>YES</b> <input type="checkbox"/> <b>NO</b></p> <p>Describe more specific faults and/or other information</p>																														
<b>Date</b>	<b>Sign</b>																														

<b>Test Case</b>	<b>Task 3:65 DVB-T2: Performance: Performance in Time-Varying Channels</b>
<b>Section</b>	NorDig Unified 3.4.10.9

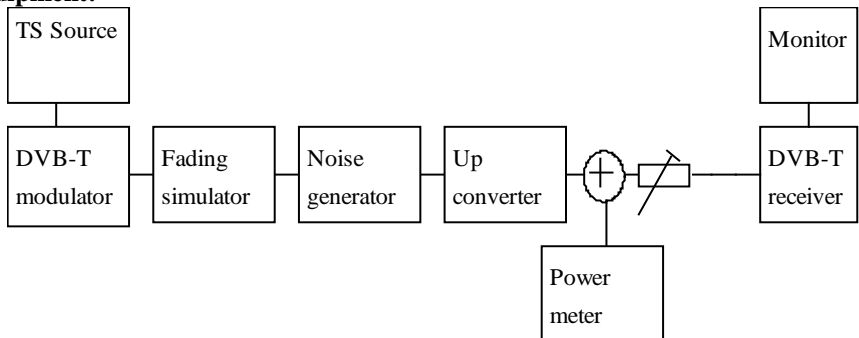
<p><b>Requirement</b></p>	<p>The NorDig IRD shall be able to operate with all signal time variations that naturally exist in connection with fixed roof-top reception (e.g. mast sway, antenna sway) and in-house portable reception (e.g. people walking around the receiving antenna). None of the above mentioned performance parameters should be significantly negatively affected when such channel time variations exist.</p> <p>The increase in required C/N for QEF reception shall be less than 3 dB for a 0 dB echo with frequency separation equal to 20 Hz and a delay of 20 <math>\mu</math>s, corresponding to a Doppler shift of +/- 10 Hz (after AFC), compared to a 0 dB echo with frequency separation equal to 1 Hz and a delay of 20 <math>\mu</math>s, corresponding to a Doppler shift of +/- 0.5 Hz (after AFC). The requirements in this paragraph refer for DVB-T to the modes {8K, 64-QAM, R=2/3, <math>\Delta</math>/Tu =1/8} and {8K, 64-QAM, R=2/3, <math>\Delta</math>/Tu =1/4}.</p> <p>The increase in required C/N for QEF reception shall be less than 3 dB for a 0 dB echo with frequency separation equal to 10 Hz and a delay of 20 <math>\mu</math>s, corresponding to a Doppler shift of +/- 5 Hz (after AFC), compared to a 0 dB echo with frequency separation equal to 1 Hz and a delay of 20 <math>\mu</math>s, corresponding to a Doppler shift of +/- 0.5 Hz (after AFC). The requirement in this paragraph refer for DVB-T to the mode {8K, 64-QAM, R=3/4, <math>\Delta</math>/Tu =1/4} and for DVB-T2 to the modes given in (1). For 1.7 MHz these DVB-T2 modes apply as well, except that the FFT size is 8K</p>
<p><b>IRD Profile(s)</b></p>	<p>Basic, IRD, DVB-T2</p>
<p><b>Test procedure</b></p>	<p><b>Purpose of test:</b> To verify the reception on a channel where time variations exists.</p> <p>1.7MHz BW DVB-T2 modes are optional to test.</p> <p><b>Equipment:</b></p>  <pre> graph LR     TS[TS Source] --&gt; Mod[DVB-T modulator]     Mod --&gt; Fading[Fading simulator]     Fading --&gt; Noise[Noise generator]     Noise --&gt; Up[Up converter]     Up --&gt; Circ(( ))     Circ --- PM[Power meter]     Circ --&gt; Rec[DVB-T receiver]     Rec --- Mon[Monitor]   </pre> <p>The 0 degree channel center shall be used in fading simulator (see 2.3.5). This is valid for 0Hz doppler shift.</p> <p>Use Mode A (Single PLP) parameter settings defined in 2.3.7Summary of DVB-T2 modes in DVB-T2 test tasks.</p> <p><b>Test procedure:</b></p> <ol style="list-style-type: none"> <li>1. Set up the test instruments.</li> <li>2. Use the following DVB-T2 mode: {32K extended, 256-QAM rotated, R=3/4, <math>\Delta</math>/Tu=1/128}.</li> <li>3. Use channel K45 (666MHz).</li> <li>4. Configure path 1 to type of static, attenuation 0dB, delay 0<math>\mu</math>s.</li> <li>5. Configure path 2 to type of pure Doppler, attenuation 0dB, delay 20<math>\mu</math>s and frequency separation to 0Hz.</li> <li>6. Set the receiver input level to -50 dBm.</li> </ol>

7. Increase the C/N from low value to higher value until the quality measurement procedure 2 (QMP2) is fulfilled.
8. Fill in the measured value in dB in the measurement record.
9. Repeat the test for the rest of the frequency separation values in the measurement record. Be careful of value which is configured in fading simulator. It can be speed, Doppler or frequency separation.
10. Fill the C/N result in the measurement record.
11. Repeat the test for the rest of the DVB-T2 modes in measurement record.

**Expected result:**

For the DVB-T2 modes the increase in the required C/N shall be less than 3dB for 0dB 20μs echo from frequency separation 1Hz to 10Hz.

**Test result(s)**

Measurement record:

Mode	0dB echo delay [μs]	Frequency separation [Hz]	C/N [dB]
32K extended, 256QAM, PP2, R=3/4, Δ/T <sub>U</sub> =1/8, 8MHz, 666MHz	20μs	0Hz	
32K extended, 256QAM, PP2, R=3/4, Δ/T <sub>U</sub> =1/8, 8MHz, 666MHz	20μs	1Hz	
32K extended, 256QAM, PP2, R=3/4, Δ/T <sub>U</sub> =1/8, 8MHz, 666MHz	20μs	5Hz	
32K extended, 256QAM, PP2, R=3/4, Δ/T <sub>U</sub> =1/8, 8MHz, 666MHz	20μs	10Hz	
32K extended, 256QAM, PP4, R=3/5, Δ/T <sub>U</sub> =19/256, 8MHz, 666MHz	20μs	0Hz	
32K extended, 256QAM, PP4, R=3/5, Δ/T <sub>U</sub> =19/256, 8MHz, 666MHz	20μs	1Hz	
32K extended, 256QAM, PP4, R=3/5, Δ/T <sub>U</sub> =19/256, 8MHz, 666MHz	20μs	5Hz	
32K extended, 256QAM, PP4, R=3/5, Δ/T <sub>U</sub> =19/256, 8MHz, 666MHz	20μs	10Hz	
32K extended, 256QAM, PP4, R=2/3, Δ/T <sub>U</sub> =1/16, 8MHz, 666MHz	20μs	0Hz	
32K extended, 256QAM, PP4, R=2/3, Δ/T <sub>U</sub> =1/16, 8MHz, 666MHz	20μs	1Hz	
32K extended, 256QAM, PP4, R=2/3, Δ/T <sub>U</sub> =1/16, 8MHz, 666MHz	20μs	5Hz	
32K extended, 256QAM, PP4, R=2/3, Δ/T <sub>U</sub> =1/16, 8MHz, 666MHz	20μs	10Hz	
32K normal, 256QAM, PP4, R=2/3, Δ/T <sub>U</sub> =19/256, 7MHz, 198.5MHz	20μs	0Hz	
32K normal, 256QAM, PP4, R=2/3, Δ/T <sub>U</sub> =19/256, 7MHz, 198.5MHz	20μs	1Hz	
32K normal, 256QAM, PP4, R=2/3, Δ/T <sub>U</sub> =19/256, 7MHz, 198.5MHz	20μs	5Hz	
32K normal, 256QAM, PP4, R=2/3, Δ/T <sub>U</sub> =19/256, 7MHz, 198.5MHz	20μs	10Hz	

	32K normal, 256QAM, PP2, R=3/4, $\Delta/T_U = 1/8$ , 7MHz, 198.5MHz	20 $\mu$ s	0Hz	
	32K normal, 256QAM, PP2, R=3/4, $\Delta/T_U = 1/8$ , 7MHz, 198.5MHz	20 $\mu$ s	1Hz	
	32K normal, 256QAM, PP2, R=3/4, $\Delta/T_U = 1/8$ , 7MHz, 198.5MHz	20 $\mu$ s	5Hz	
	32K normal, 256QAM, PP2, R=3/4, $\Delta/T_U = 1/8$ , 7MHz, 198.5MHz	20 $\mu$ s	10Hz	
Table 1. Mandatory DVB-T2 modes				
	8K normal, 256QAM, PP2, R=2/3, $\Delta/T_U = 1/8$ , 1.7MHz, 206.352MHz	20 $\mu$ s	0Hz	
	8K normal, 256QAM, PP2, R=2/3, $\Delta/T_U = 1/8$ , 1.7MHz, 206.352MHz	20 $\mu$ s	1Hz	
	8K normal, 256QAM, PP2, R=2/3, $\Delta/T_U = 1/8$ , 1.7MHz, 206.352MHz	20 $\mu$ s	5Hz	
	8K normal, 256QAM, PP2, R=2/3, $\Delta/T_U = 1/8$ , 1.7MHz, 206.352MHz	20 $\mu$ s	10Hz	
Table 2. Optional DVB-T2 modes				
<b>Conformity</b>	<input type="checkbox"/> OK Fault <input type="checkbox"/> Major <input type="checkbox"/> Minor, define fail reason in comments			
<b>Comments</b>	If possible describe if fault can be fixed with software update: <input type="checkbox"/> YES <input type="checkbox"/> NO Describe more specific faults and/or other information			
<b>Date</b>		<b>Sign</b>		

<b>Test Case</b>	<b>Task 3:66 DVB-T2: Performance: Synchronisation for varying echo power levels in SFN</b>
<b>Section</b>	NorDig Unified 3.4.10.10
<b>Requirement</b>	For the DVB-T modes {8K, 64-QAM, R=2/3, $\Delta/T_U = 1/8$ }, {8K, 64-QAM, R=2/3, $\Delta/T_U = 1/4$ } and {8K, 64-QAM, R=3/4, $\Delta/T_U = 1/4$ }, the required C/N value, specified in NorDig specification, for QEF reception shall be obtained when the channel contains two paths with relative delay from 1.95 $\mu$ s up to 0.95 times guard interval length and the relative power levels of the two paths are dynamically varying including 0dB echo level crossing. The C/N value is defined at 0 dB level crossing. For the DVB-T2 modes given in Table 2.4, the required C/N value, specified in NorDig Specification, for QEF reception shall be obtained when the channel contains two paths with relative delay from 1.95 $\mu$ s up to 0.95 times guard interval length and the relative power levels of the two paths are dynamically varying including 0dB echo level crossing. The C/N value is defined at 0 dB level crossing.
<b>IRD Profile(s)</b>	Basic, IRD, DVB-T2
<b>Test procedure</b>	<b>Purpose of test:</b> To verify the SFN synchronisation when the amplitude of the echo compared to the amplitude of the direct signal varies in a function of time.  1.7 MHz DVB-T2 modes not tested.  <b>Equipment:</b>







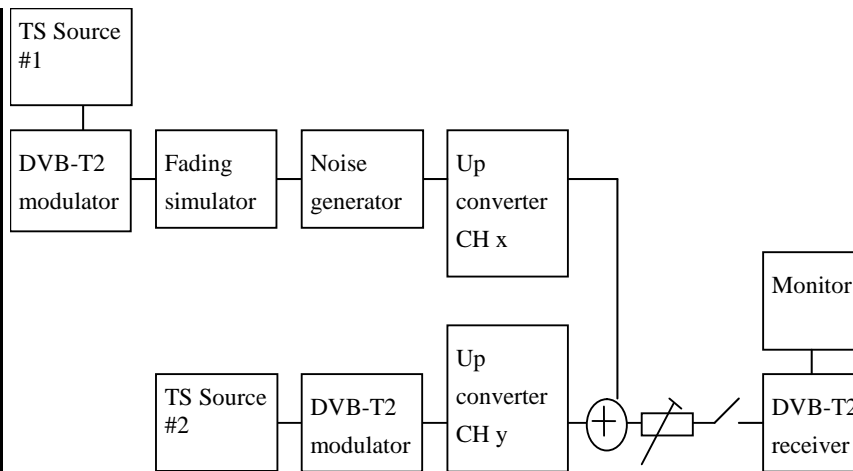

The 0 degree at channel center shall be used in fading simulator (see 2.3.5).

Use Mode A (Single PLP) parameter settings defined in 2.3.7 Summary of DVB-T2 modes in DVB-T2 test tasks.

1.7MHz signal BW DVB-T2 modes are tested on 206.352MHz (9C)

7MHz signal BW DVB-T2 modes are tested on 198.5MHz (K8)

8MHz signal BW DVB-T2 modes are tested on 666MHz (K45),

**Test procedure:**

Check the different SFN synchronisation issues from 2.3.4 Receiver operability in SFN.

1. Set up the test instruments.
2. Use the following DVB-T2 mode 32K extended, 256QAM, PP4, R=2/3,  $\Delta/T_U=1/16$  and signal bandwidth 8MHz and center frequency 666MHz (K45).
3. Open the switch.
4. Configure one path of the channel simulator to have a 0dB attenuation, 0 $\mu$ s delay and 0 degree phase.
5. Configure the second path of the channel simulator to have relative delay difference -100.1 $\mu$ s and attenuation 21dB (pre echo) and 0 degree phase.
6. Configure the third path of the channel simulator to have relative delay difference +100.0 $\mu$ s and attenuation 15 dB (post echo) and 0 degree phase.
7. Set the receiver input level to -50 dBm.
8. Close the switch.
9. Increase the required C/N value from low value to higher value until the quality measurement procedure 2 (QMP2) is fulfilled.
10. Fill in the required C/N value in dB in the measurement record.
11. Measure the rest of the required C/N values starting at the bottom of the table and upward.
12. Fill in the results in the measurement record. During the change of the delay and the attenuation, the input RF signal to receiver shall be disconnected.
13. Repeat the test for the rest of the DVB-T2 modes.

**Expected result:**

The IRD shall synchronize in all combinations defined in measurement record and the required C/N value shall not exceed the required C/N defined for profile 2: 0dB echo in table 2.3 (PP2) and table 2.4 (PP4).

**Test result(s)**

Measurement record:

32k extended 256QAM PP4 R=2/3 $\Delta/T_U=1/16$ , 8MHz, f=666MHz						
Main path		Pre echo		Post echo		C/N [dB]
Att [dB]	Delay [us]	Att [dB]	Delay [us]	Att [dB]	Delay [us]	
0	0	0	-100.1	0	100	
0	0	3	-100.1	3	100	
0	0	6	-100.1	6	100	
0	0	9	-100.1	9	100	
0	0	12	-100.1	12	100	
0	0	15	-100.1	15	100	
0	0	18	-100.1	18	100	
0	0	21	-100.1	21	100	
0	0	15	-100.1	0	100	
0	0	15	-100.1	3	100	
0	0	15	-100.1	6	100	
0	0	15	-100.1	9	100	
0	0	15	-100.1	12	100	
0	0	15	-100.1	18	100	
0	0	15	-100.1	21	100	
0	0	0	-100.1	15	100	
0	0	3	-100.1	15	100	
0	0	6	-100.1	15	100	
0	0	9	-100.1	15	100	
0	0	12	-100.1	15	100	
0	0	18	-100.1	15	100	
0	0	21	-100.1	15	100	

32k extended 256QAM PP4 R=3/5 $\Delta/T_U=19/256$ , 8MHz, f=666MHz						
Main path		Pre echo		Post echo		C/N [dB]
Att [dB]	Delay [us]	Att [dB]	Delay [us]	Att [dB]	Delay [us]	
0	0	0	-120.1	0	+120.0	
0	0	3	-120.1	3	+120.0	
0	0	6	-120.1	6	+120.0	
0	0	9	-120.1	9	+120.0	
0	0	12	-120.1	12	+120.0	
0	0	15	-120.1	15	+120.0	
0	0	18	-120.1	18	+120.0	
0	0	21	-120.1	21	+120.0	
0	0	15	-120.1	0	+120.0	
0	0	15	-120.1	3	+120.0	
0	0	15	-120.1	6	+120.0	

0	0	15	-120.1	9	+120.0	
0	0	15	-120.1	12	+120.0	
0	0	15	-120.1	18	+120.0	
0	0	15	-120.1	21	+120.0	
0	0	0	-120.1	15	+120.0	
0	0	3	-120.1	15	+120.0	
0	0	6	-120.1	15	+120.0	
0	0	9	-120.1	15	+120.0	
0	0	12	-120.1	15	+120.0	
0	0	15	-120.1	15	+120.0	
0	0	18	-120.1	15	+120.0	
0	0	21	-120.1	15	+120.0	

32k normal 256QAM PP2 R=2/3 $\Delta/T_0=1/8$ , 7MHz, f=198.5MHz						
Main path		Pre echo		Post echo		C/N [dB]
Att [dB]	Delay [us]	Att [dB]	Delay [us]	Att [dB]	Delay [us]	
0	0	0	-243.1	0	+243.0	
0	0	3	-243.1	3	+243.0	
0	0	6	-243.1	6	+243.0	
0	0	9	-243.1	9	+243.0	
0	0	12	-243.1	12	+243.0	
0	0	15	-243.1	15	+243.0	
0	0	18	-243.1	18	+243.0	
0	0	21	-243.1	21	+243.0	
0	0	15	-243.1	0	+243.0	
0	0	15	-243.1	3	+243.0	
0	0	15	-243.1	6	+243.0	
0	0	15	-243.1	9	+243.0	
0	0	15	-243.1	12	+243.0	
0	0	15	-243.1	18	+243.0	
0	0	15	-243.1	21	+243.0	
0	0	0	-243.1	15	+243.0	
0	0	3	-243.1	15	+243.0	
0	0	6	-243.1	15	+243.0	
0	0	9	-243.1	15	+243.0	
0	0	12	-243.1	15	+243.0	
0	0	15	-243.1	15	+243.0	
0	0	18	-243.1	15	+243.0	
0	0	21	-243.1	15	+243.0	

<b>Conformity</b>	<input type="checkbox"/> OK Fault <input type="checkbox"/> Major <input type="checkbox"/> Minor, define fail reason in comments
<b>Comments</b>	If possible describe if fault can be fixed with software update: <input type="checkbox"/> YES <input type="checkbox"/> NO Describe more specific faults and/or other information

<i>Date</i>		<i>Sign</i>	

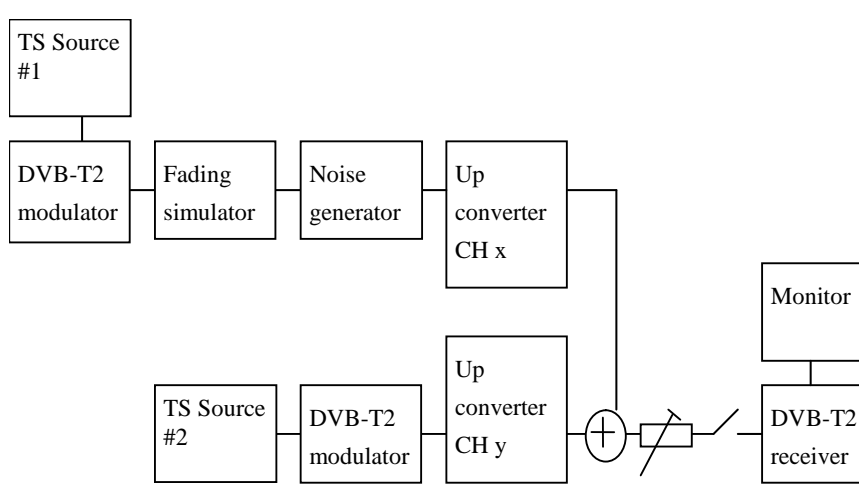
<b>Test Case</b>	<b>Task 3:68 DVB-T2: Performance: C/(N+I) Performance in SFN inside the guard interval</b>																		
<b>Section</b>	NorDig Unified 3.4.10.11																		
<b>Requirement</b>	<p>For the DVB-T2 modes shown in (1), the required C/N value for profile 2 (specified in (1)) for QEF reception shall be obtained when the channel contains two static paths with relative delay from 1.95<math>\mu</math>s up to 0.95 times guard interval length, independently of the relative amplitudes and phases of the two paths. For 1.7 MHz these DVB-T2 modes apply as well, except that the FFT size is 8K</p> <p>For specific echo attenuation, the required C/N shall not be more than 1 dB higher compared to the median value when calculated for the required C/N values over the echo delays from 1.95 <math>\mu</math>s up to 0.95 times guard interval length.</p>																		
<b>IRD Profile(s)</b>	Basic, IRD, DVB-T2																		
<b>Test procedure</b>	<p><b>Purpose of test:</b> To verify the required C/N for echoes in SFN inside the guard interval.</p> <p><b>Equipment:</b></p>  <p>Common DVB-T2 parameters in this test task:</p> <table border="1" style="width: 100%;"> <tr> <td>Constellation rotation</td> <td>Yes</td> </tr> <tr> <td>PAPR</td> <td>L1-ACE &amp; TR PAPR</td> </tr> <tr> <td>SISO/MISO</td> <td>SISO</td> </tr> <tr> <td>FEC Frame length</td> <td>64800</td> </tr> <tr> <td>Input mode</td> <td>Mode A</td> </tr> <tr> <td>TFS</td> <td>No</td> </tr> <tr> <td>Mode</td> <td>HEM (high efficiency mode)</td> </tr> <tr> <td>FEF</td> <td>Not used</td> </tr> <tr> <td>Auxiliary streams</td> <td>Not used</td> </tr> </table>	Constellation rotation	Yes	PAPR	L1-ACE & TR PAPR	SISO/MISO	SISO	FEC Frame length	64800	Input mode	Mode A	TFS	No	Mode	HEM (high efficiency mode)	FEF	Not used	Auxiliary streams	Not used
Constellation rotation	Yes																		
PAPR	L1-ACE & TR PAPR																		
SISO/MISO	SISO																		
FEC Frame length	64800																		
Input mode	Mode A																		
TFS	No																		
Mode	HEM (high efficiency mode)																		
FEF	Not used																		
Auxiliary streams	Not used																		







13												
14												
15												
16												
17												
18												
19												
20												
21												
dB /us	-1.95	-10	-25	-33	-50	-66	-133	-150	-170	-190	-253	-266
0												
1												
2												
3												
4												
5												
6												
7												
8												
9												
10												
11												
12												
13												
14												
15												
16												
17												
18												
19												
20												
21												

<b>32k extended 256QAM PP2 R=3/4 <math>\Delta/T_0=1/8</math>, 8MHz</b>												
dB /us	1.95	10	28	56	70	112	224	320	384	400	426	448
0												
1												
2												
3												
4												
5												
6												
7												
8												
9												
10												
11												
12												
13												
14												
15												
16												
17												
18												
19												
20												
21												
dB /us	-1.95	-10	-28	-56	-70	-112	-224	-320	-384	-400	-426	-448

0												
1	■		■		■		■		■		■	
2												
3												
4	■		■		■		■		■		■	
5												
6												
7	■		■		■		■		■		■	
8												
9												
10	■		■		■		■		■		■	
11												
12												
13	■		■		■		■		■		■	
14												
15												
16	■		■		■		■		■		■	
17												
18												
19	■		■		■		■		■		■	
20												
21												

**32K normal, 256QAM, PP4, R=2/3,  $\Delta/T_U=19/256$ , 7MHz**

dB /us	1.95	10	28	76	128	152	256	289	304
0									
1	■		■		■		■		■
2									
3									
4	■		■		■		■		■
5									
6									
7	■		■		■		■		■
8									
9									
10	■		■		■		■		■
11									
12									
13	■		■		■		■		■
14									
15									
16	■		■		■		■		■
17									
18									
19	■		■		■		■		■
20									
21									

dB /us	-1.95	-10	-28	-76	-128	-152	-256	-289	-304
0									
1	■		■		■		■		■
2									
3									
4	■		■		■		■		■
5									
6									
7	■		■		■		■		■
8									
9									
10	■		■		■		■		■
11									
12									
13	■		■		■		■		■

14									
15									
16									
17									
18									
19									
20									
21									

<b>32K normal, 256QAM, PP2, R=3/4, Δ/T<sub>U</sub>=1/8, 7MHz</b>												
dB /us	1.95	10	28	56	128	170	256	320	384	416	486	500
0												
1												
2												
3												
4												
5												
6												
7												
8												
9												
10												
11												
12												
13												
14												
15												
16												
17												
18												
19												
20												
21												
dB /us	-1.95	-10	-28	-56	-128	-170	-256	-320	-384	-416	-486	-500
0												
1												
2												
3												
4												
5												
6												
7												
8												
9												
10												
11												
12												
13												
14												
15												
16												
17												
18												
19												
20												
21												

<b>Conformity</b>	<input type="checkbox"/> OK <input type="checkbox"/> Fault <input type="checkbox"/> Major <input type="checkbox"/> Minor, define fail reason in comments
<b>Comments</b>	If possible describe if fault can be fixed with software update: <input type="checkbox"/> YES <input type="checkbox"/> NO

	Describe more specific faults and/or other information		
<i>Date</i>		<i>Sign</i>	

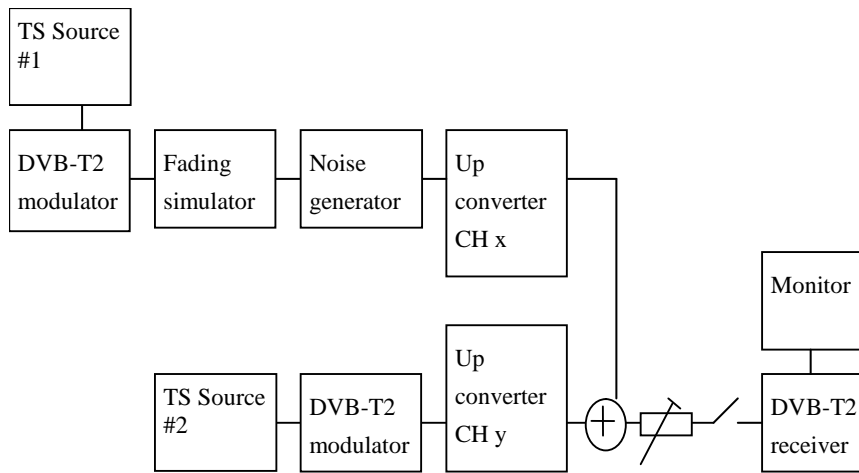
<b>Test Case</b>	<b>Task 3:69 DVB-T2: Performance: C/(N+I) Performance in SFN outside the guard interval</b>																				
<b>Section</b>	NorDig Unified 3.4.10.11																				
<b>Requirement</b>	<p>For echoes outside the guard interval, for 8 MHz DVB-T2 signal, QEF reception shall be possible with echo levels up to the values defined in Table 3.24.</p> <p>For echoes outside the guard interval, for 7 MHz DVB-T2 signal, QEF reception shall be possible with echo levels up to the values defined in Table 3.25.</p>																				
<b>IRD Profile(s)</b>	Basic, IRD, DVB-T2																				
<b>Test procedure</b>	<p><b>Purpose of test:</b> To verify the SFN synchronisation in SFN for echoes outside guard interval.</p> <p><b>Equipment:</b></p>  <p>Common DVB-T2 parameters in this test task:</p> <table border="1" data-bbox="462 1556 1268 1937"> <tr> <td>Constellation rotation</td> <td>Yes</td> </tr> <tr> <td>PAPR</td> <td>L1-ACE &amp; TR PAPR</td> </tr> <tr> <td>SISO/MISO</td> <td>SISO</td> </tr> <tr> <td>FEC Frame length</td> <td>64800</td> </tr> <tr> <td>Input mode</td> <td>Mode A</td> </tr> <tr> <td>TFS</td> <td>No</td> </tr> <tr> <td>Mode</td> <td>HEM (high efficiency mode)</td> </tr> <tr> <td>FEF</td> <td>Not used</td> </tr> <tr> <td>Auxiliary streams</td> <td>Not used</td> </tr> </table> <p><b>Test procedure for evaluation of synchronization for echoes outside the guard</b></p>			Constellation rotation	Yes	PAPR	L1-ACE & TR PAPR	SISO/MISO	SISO	FEC Frame length	64800	Input mode	Mode A	TFS	No	Mode	HEM (high efficiency mode)	FEF	Not used	Auxiliary streams	Not used
Constellation rotation	Yes																				
PAPR	L1-ACE & TR PAPR																				
SISO/MISO	SISO																				
FEC Frame length	64800																				
Input mode	Mode A																				
TFS	No																				
Mode	HEM (high efficiency mode)																				
FEF	Not used																				
Auxiliary streams	Not used																				

**interval:**

Check the different SFN synchronisation issues from 2.3.4 Receiver operability in SFN.

1. Set up the test instruments.
2. Use the following mode {32K, 256QAM, PP4, R=3/5,  $\Delta/T_U=1/16$ } and signal bandwidth 8MHz.
3. Open the switch.
4. Set the receiver input level to -50 dBm for the wanted signal.
5. Set the channel simulator relative delay difference to 260 $\mu$ s for the echo signal.
6. Close the switch.
7. Increase the echo attenuation from low value to higher value until quality measurement procedure 2 (QMP2) is fulfilled.
8. Fill in echo attenuation result in dB in the measurement record.
9. Repeat the test the rest of the combinations of the relative delays and attenuation levels defined in measurement record.. Open the switch before changing the delay and attenuation level.
10. Repeat the test for the rest of the DVB-T2 modes in the measurement record for the signal bandwidth 8MHz.
11. Set the up-converter to center frequency 198.5MHz (K8).
12. Follow the test procedure and repeat the test for the 7 MHz signal bandwidth and DVB-T2 modes defined in the measurement record according to procedure above.

**Expected result:**

All the echo attenuation values shall be equal or lower compared to NorDig Unified values in tables 3.2 and 3.23.

**Test result(s)**

Measurement record:

7 MHz signal bandwidth					
DVB-T2 mode	Echo delay [ $\mu$ s]				
	-298	-266	-215	-165	-135
32K nor, 256-QAM, PP4, R=3/5, GI=1/16					
32K nor, 256-QAM, PP4, R=2/3, GI =1/16					
32K nor, 256-QAM, PP4, R=3/4, GI =1/16					
32K nor, 256-QAM, PP4, R=3/5, GI =1/32					
32K nor, 256-QAM, PP4, R=2/3, GI =1/32					
32K nor, 256-QAM, PP4, R=3/4, GI =1/32					
Echo delay [ $\mu$ s]					
	298	266	215	165	135
32K nor, 256-QAM, PP4, R=3/5, GI =1/16					
32K nor, 256-QAM, PP4, R=2/3, GI =1/16					
32K nor, 256-QAM, PP4, R=3/4, GI =1/16					
32K nor, 256-QAM, PP4, R=3/5, GI =1/32					
32K nor, 256-QAM, PP4, R=2/3, GI =1/32					
32K nor, 256-QAM, PP4, R=3/4, GI =1/32					

7 MHz signal bandwidth					
DVB-T2 mode	Echo delay [ $\mu$ s]				
	-608	-512	-400	-298	-266
32K nor, 256-QAM, PP2, R=3/5, GI=1/16					
32K nor, 256-QAM, PP2, R=2/3, GI =1/16					
32K nor, 256-QAM, PP2, R=3/4, GI =1/16					
Echo delay [ $\mu$ s]					
	608	512	400	298	266
32K nor, 256-QAM, PP2, R=3/5, GI =1/16					

	32K nor, 256-QAM, PP2, R=2/3, GI =1/16						
	32K nor, 256-QAM, PP2, R=3/4, GI =1/16						
	<b>8 MHz signal bandwidth</b>						
	DVB-T2 mode	<b>Echo delay [µs]</b>					
		-260	-230	-200	-150	-120	
	32K ext, 256-QAM, PP4, R=3/5, GI =1/16						
	32K ext, 256-QAM, PP4, R=2/3, GI =1/16						
	32K ext, 256-QAM, PP4, R=3/4, GI =1/16						
	32K ext, 256-QAM, PP4, R=3/5, GI =1/32						
	32K ext, 256-QAM, PP4, R=2/3, GI =1/32						
	32K ext, 256-QAM, PP4, R=3/4, GI =1/32						
		<b>Echo delay [µs]</b>					
		260	230	200	150	120	
	32K ext, 256-QAM, PP4, R=3/5, GI =1/16						
	32K ext, 256-QAM, PP4, R=2/3, GI =1/16						
	32K ext, 256-QAM, PP4, R=3/4, GI =1/16						
	32K ext, 256-QAM, PP4, R=3/5, GI =1/32						
	32K ext, 256-QAM, PP4, R=2/3, GI =1/32						
	32K ext, 256-QAM, PP4, R=3/4, GI =1/32						
	<b>Conformity</b>	<input type="checkbox"/> <b>OK Fault</b> <input type="checkbox"/> Major <input type="checkbox"/> Minor, define fail reason in comments					
<b>Comments</b>	If possible describe if fault can be fixed with software update: <input type="checkbox"/> <b>YES</b> <input type="checkbox"/> <b>NO</b> Describe more specific faults and/or other information						
<b>Date</b>				<b>Sign</b>			

## 2.4 Task 4: IP-Based Front-end

- Not yet available-



## 2.5 Task 5: MPEG2 demultiplexer

<b>Test Case</b>	<b>Task 5:1 SI utilization</b>
<b>Section</b>	NorDig Unified 4.1
<b>Requirement</b>	
<b>IRD Profile(s)</b>	Basic, IRD, FE
<b>Test procedure</b>	Utilization of MPEG-2 Service Information shall be tested under Task 8.

<b>Test Case</b>	<b>Task 5:2 CA descriptor interpretation</b>
<b>Section</b>	NorDig Unified 4.1
<b>Requirement</b>	The NorDig IRD shall interpret the CA descriptor as defined in ETR 289
<b>IRD Profile(s)</b>	Basic, IRD, FE
<b>Test procedure</b>	This test is covered with tests Task 13:25, Task 10:1 and Task 10:2

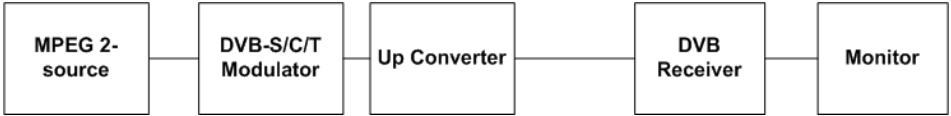
<b>Test Case</b>	<b>Task 5:3 Maximum transport stream data rate</b>
<b>Section</b>	NorDig Unified 4.1 and 3
<b>Requirement</b>	The NorDig IRD <b>shall</b> be able to decode an ISO/IEC 13818-1 stream with data rates up to that include all rates that the front-end may deliver as defined in NorDig Unified chapter 3. Note: The satellite front-end may deliver up to 80.4 Mbps after error correction
<b>IRD Profile(s)</b>	Basic, IRD, FE
<b>Test procedure</b>	<p><b>Purpose of test:</b> Purpose of the test is to verify that IRD supports maximum transport stream data rate.</p> <p><b>Equipment:</b></p>  <pre> graph LR     A[MPEG 2-source] --&gt; B[DVB-S/C/T Modulator]     B --&gt; C[Up Converter]     C --&gt; D[DVB Receiver]     D --&gt; E[Monitor]   </pre> <p><b>Terrestrial front-end (DVB-T) only:</b> Test multiplex with the maximum bitrate of 31.67 Mbit/s and carrying one or more services with video/audio content and teletext components.</p> <p><b>Satellite front-ends only:</b> Test multiplex with the maximum bitrate of 72 Mbit/s and carrying one or more services with video/audio content and teletext components.</p> <p><b>Cable front-ends only:</b> Test multiplex with the maximum bitrate of 53,45 Mbit/s and carrying one or more services with video/audio content and teletext components.</p> <p><b>IP-front-end only:</b> <b>TBD</b></p> <p><b>Test procedure:</b></p>



	This is general requirement that will be test in front-end tests.	
	<b>Expected result:</b>	
<i>Test result(s)</i>		
<i>Conformity</i>	<input type="checkbox"/> <b>OK Fault</b> <input type="checkbox"/> Major <input type="checkbox"/> Minor, define fail reason in comments	
<i>Comments</i>	If possible describe if fault can be fixed with software update: <input type="checkbox"/> <b>YES</b> <input type="checkbox"/> <b>NO</b> Describe more specific faults and/or other information	
<i>Date</i>		<i>Sign</i>

<i>Test Case</i>	<b>Task 5:4 Number of elementary streams</b>	
<i>Section</i>	NorDig Unified 4.1	
<i>Requirement</i>	The NorDig IRD shall be capable to utilise at least 32 elementary streams simultaneously, which requires 32 PID filters.	
<i>IRD Profile(s)</i>	Basic, IRD, FE	
<i>Test procedure</i>	<p><b>Purpose of test:</b> To verify IRD's capability to utilize at least 32 elementary streams simultaneously.</p> <p><b>Equipment:</b> The manufacturer describes his specific set-up for the test</p> <p><b>Test procedure:</b> Due to the complexity to test the ability to handle 32 elementary streams simultaneously, this test can be difficult to fully test.  Instead the supplier shall ensure that this requirement is met.</p> <p>If no such statement of conformance is issued, a test containing the maximum number of components used in the broadcast network should be performed. At least following amount and types of components shall be tested within a service:</p> <ul style="list-style-type: none"> <li>• Audio MPEG1 LII</li> <li>• audio AC-3,</li> <li>• video,</li> <li>• EBU teletext</li> <li>• DVB subtitling</li> <li>• Data, e.g. DSMCC data craousel.</li> </ul> <p>In the future up to three PID's for data applications could be included.</p> <p>Note: The number simultaneously elementary streams used in the test shall be stated in the comments below.</p>	
<i>Test result(s)</i>		
<i>Conformity</i>	<input type="checkbox"/> <b>OK Fault</b> <input type="checkbox"/> Major <input type="checkbox"/> Minor, define fail reason in comments	
<i>Comments</i>	If possible describe if fault can be fixed with software update: <input type="checkbox"/> <b>YES</b> <input type="checkbox"/> <b>NO</b> Describe more specific faults and/or other information	
<i>Date</i>		<i>Sign</i>



<b>Test Case</b>	<b>Task 5:5 Section filtering</b>	
<b>Section</b>	NorDig Unified 4.1	
<b>Requirement</b>	The NorDig IRD shall provide at least 32 section filters.	
<b>IRD Profile(s)</b>	Basic, IRD, FE	
<b>Test procedure</b>	<p><b>Purpose of test:</b> To verify IRD's capability to utilize at least 32 sections.</p> <p><b>Equipment:</b> The manufacturer describes his specific set-up for the test</p> <p><b>Test procedure:</b></p> <p>The stream_type 0x05 corresponds private sections. One section is 4096 bytes. Therefore, the requirement is up 32 * 4096 bytes.</p> <p>All PSI/SI data transmitted in sections. Therefore, the requirement of amount PSI/SI sections to handle is 32 * 4096 bytes.</p> <p><b>Expected result:</b> The supplier shall ensure that this requirement is met.</p>	
<b>Test result(s)</b>		
<b>Conformity</b>	<input type="checkbox"/> <b>OK Fault</b> <input type="checkbox"/> Major <input type="checkbox"/> Minor, define fail reason in comments	
<b>Comments</b>	If possible describe if fault can be fixed with software update: <input type="checkbox"/> <b>YES</b> <input type="checkbox"/> <b>NO</b> Describe more specific faults and/or other information	
<b>Date</b>		<b>Sign</b>

<b>Test Case</b>	<b>Task 5:6 Variable Bitrate Elementary Streams</b>	
<b>Section</b>	NorDig Unified 4.1	
<b>Requirement</b>	The NorDig IRD shall support variable bitrate elementary streams within a constant bitrate transport stream (excluding audio).	
<b>IRD Profile(s)</b>	Basic, IRD, FE	

<b>Test procedure</b>	<p><b>Purpose of test:</b> To verify that the IRD can decode a variable bitrate video stream (statistical multiplexing).</p> <p><b>Test Equipment:</b> Test signals are created using the test bed shown below:</p> <div style="text-align: center;">  <pre> graph LR     A[MPEG 2-source] --&gt; B[DVB-S/C/T Modulator]     B --&gt; C[Up Converter]     C --&gt; D[DVB Receiver]     D --&gt; E[Monitor]             </pre> </div> <p><b>Test signal configuration:</b></p> <p>The bitrate variation range in test streams shall be e.g.:</p> <ul style="list-style-type: none"> <li>- 6 – 11 Mbit/s</li> <li>- 2 – 6 Mbit/s</li> <li>- 2 – 6 Mbit/s</li> <li>- 3 – 11 Mbit/s</li> </ul> <p><b>Test procedure:</b> The IRD is tuned to a Transport Stream that contains variable bitrate Elementary Streams (statistical multiplexing of video). No noise added IRD input level: -60 dBm RGB pictures displayed on a monitor is observed.</p> <p><b>Expected result:</b> The IRD is capable of displaying an error-free picture during 5 minutes. The audio and video shall be muted during acquisition.</p>
<b>Test result(s)</b>	
<b>Conformity</b>	<input type="checkbox"/> OK Fault <input type="checkbox"/> Major <input type="checkbox"/> Minor, define fail reason in comments
<b>Comments</b>	If possible describe if fault can be fixed with software update: <input type="checkbox"/> YES <input type="checkbox"/> NO Describe more specific faults and/or other information
<b>Date</b>	<b>Sign</b>

<b>Test Case</b>	<b>Task 5:7 Mixture of SD and HD services</b>
<b>Section</b>	NorDig Unified 4.1
<b>Requirement</b>	The NorDig HDTV IRD shall support a mixture of service types within the same ISO/IEC 13818-1[42] MPEG-2 transport stream (i.e. MPEG-2 SDTV service, MPEG-4 AVC SDTV and HDTV and Radio services may be multiplexed into the same transport stream).
<b>IRD Profile(s)</b>	Basic, IRD, FE

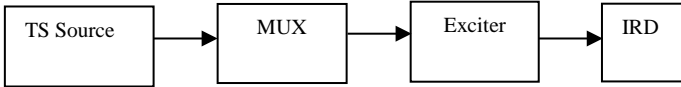
<b>Test procedure</b>	<p><b>Purpose of test:</b> To verify the receiver is able to decode mixture of SD and HD services.</p> <p><b>Equipment:</b></p> <div style="text-align: center;">  <pre> graph LR     TS[TS Source] --&gt; MUX[MUX]     MUX --&gt; Exc[Exciter]     Exc --&gt; IRD[IRD]             </pre> </div> <p>Transport stream(s) containing:</p> <ul style="list-style-type: none"> <li>• Digital tv SD service (0x01) with             <ul style="list-style-type: none"> <li>○ MPEG-2 720x576i 25Hz video component</li> <li>○ MPEG-1 Layer II audio component</li> </ul> </li> <li>• Advanced codec SD digital tv service (0x16) with             <ul style="list-style-type: none"> <li>○ MPEG-4 AVC 720x576i 25Hz video component</li> <li>○ MPEG-4 HE.AAC v1 audio component</li> </ul> </li> <li>• Advanced codec HD digital tv Service (0x19) with             <ul style="list-style-type: none"> <li>○ MPEG-4 AVC 1280x720p 50Hz video component</li> <li>○ DD E-AC-3 audio component</li> </ul> </li> <li>• Digital radio sound service (0x02) with             <ul style="list-style-type: none"> <li>○ MPEG-1 Layer II audio component</li> </ul> </li> <li>• Advanced codec digital radio sound service (0x0A) with             <ul style="list-style-type: none"> <li>○ MPEG-4 HE.AAC Level 4 audio component.</li> </ul> </li> <li>• Advanced codec digital radio sound service (0x0A) with             <ul style="list-style-type: none"> <li>○ DD E-AC-3 audio component.</li> </ul> </li> </ul> <p><b>Test procedure:</b> Tune to the services and verify that the service is decoded correctly.</p> <p><b>Expected result:</b> NorDig SDTV Level IRD receiver doesn't install HD services in service list and therefore doesn't decode HD services. NorDig HDTV Level IRD is able to decode both HD and SD services.</p>
<b>Test result(s)</b>	
<b>Conformity</b>	<input type="checkbox"/> OK <input type="checkbox"/> Fault <input type="checkbox"/> Major <input type="checkbox"/> Minor, define fail reason in comments
<b>Comments</b>	If possible describe if fault can be fixed with software update: <input type="checkbox"/> YES <input type="checkbox"/> NO Describe more specific faults and/or other information
<b>Date</b>	<b>Sign</b>

<b>Test Case</b>	<b>Task 5:8 Descrambler Performance</b>
<b>Section</b>	NorDig Unified 4.2
<b>Requirement</b>	The descrambler unit is based on the common scrambling algorithm as specified by DVB, see DVB A 011 [5]. Common Scrambling Algorithms versions 2 and 3 shall (1) be implemented in the NorDig IRD. The algorithms are available from ETSI (2). See also section 9. It shall (1) be able to descramble on transport level and on PES format. The NorDig IRD shall (1) be able to process in parallel up to at least 6 different streams (either PES or transport level) with different access conditions. Data streams without access control shall be bypassed by the descrambling unit.
<b>IRD Profile(s)</b>	Basic, IRD, FE
<b>Test procedure</b>	<b>This test is tested in Task 10:</b>

<b>Test Case</b>	<b>Task 5:9 System clock recovery</b>
<b>Section</b>	NorDig Unified 4.3
<b>Requirement</b>	<p>During the system time clock (STC) acquisition audio and video shall be muted. (The transition shall be smooth and seamless when the customer changes the channel). The decoder shall be able to:</p> <ul style="list-style-type: none"> <li>•recover the STC using PCR with maximum jitter of +/- 10 <math>\mu</math>s.</li> <li>•track long-term variations in the frequency of the encoder's STC.</li> </ul> <p>For each service, the demultiplexer shall recover the source clock by extracting the associated PCR values received within the incoming multiplex and insert them into the appropriate Phase Locked Loop.</p>
<b>IRD Profile(s)</b>	Basic, IRD, FE
<b>Test procedure</b>	<p><b>Purpose of test:</b> To verify that the IRD is able to recover system clock with PCR jitter amplitudes of +/- 10 <math>\mu</math>s.</p> <p><b>Test Equipment:</b> Test signals are created using the test bed shown below:</p> <div data-bbox="387 969 1070 1055" data-label="Diagram"> <pre> graph LR     A[TS Source] --&gt; B[MUX]     B --&gt; C[Exciter]     C --&gt; D[IRD]     </pre> </div> <p>A transport stream including services with following components:</p> <ul style="list-style-type: none"> <li>• Service 1             <ul style="list-style-type: none"> <li>○ MPEG4 AVC HP@L3 576i 25Hz video PID with rapid variations of the PCR values</li> <li>○ MPEG4 HE AAC L2 audio PID</li> </ul> </li> <li>• Service 2             <ul style="list-style-type: none"> <li>○ MPEG4 AVC HP@L3 576i 25Hz video PID with longterm variations of the PCR values</li> <li>○ MPEG4 HE AAC L2 audio PID</li> </ul> </li> <li>• Service 3             <ul style="list-style-type: none"> <li>○ MPEG2 MP@ML 576i 25Hz video PID with rapid variations of the PCR values</li> <li>○ MPEG1 LII audio PID</li> </ul> </li> <li>• Service 4             <ul style="list-style-type: none"> <li>○ MPEG2 MP@ML 576i 25Hz video PID with longterm variations of the PCR values</li> <li>○ MPEG1 LII audio PID</li> </ul> </li> </ul> <p>Characteristics of the PCR variations are defined below.</p> <p>Rapid variation PCR(sawtooth wave)</p> <div data-bbox="424 1776 1142 1989" data-label="Figure"> <p>The diagram shows a sawtooth wave representing PCR variations. The horizontal axis is labeled '7 seconds' with a double-headed arrow indicating the period of one cycle. The vertical axis is labeled '±10<math>\mu</math>s' with a double-headed arrow indicating the amplitude of the variation.</p> </div>

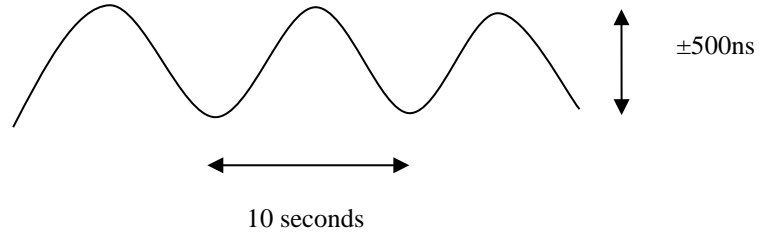
	<p>Long term variation PCR (constant sine wave)</p>  <p><b>Test procedure:</b></p> <ol style="list-style-type: none"> <li>1. Set IRD input level to -60 dBm</li> <li>2. Play out the TS</li> <li>3. Do the channel search if required</li> <li>4. Verify that IRD provides error free video and there is no irritating lipsync.</li> </ol> <p><b>Expected result:</b> The NorDig IRD is capable of displaying an error-free picture during 5 minutes. The audio and video shall be in synchronization, with other words, there is no irritating lipsync.</p>
<b>Test result(s)</b>	
<b>Conformity</b>	<input type="checkbox"/> <b>OK Fault</b> <input type="checkbox"/> Major <input type="checkbox"/> Minor, define fail reason in comments
<b>Comments</b>	If possible describe if fault can be fixed with software update: <input type="checkbox"/> <b>YES</b> <input type="checkbox"/> <b>NO</b> Describe more specific faults and/or other information
<b>Date</b>	<b>Sign</b>

## 2.6 Task 6: Video

<b>Test Case</b>	<b>Task 6:1 Video Decoder - General</b>
<b>Section</b>	NorDig Unified 5.1
<b>Requirement</b>	<p>The NorDig IRD's video decoder shall fully comply with the DVB Implementation Guidelines for the use of MPEG-2 SDTV and H.264/AVC SDTV and HDTV video in satellite, cable and terrestrial broadcasting applications, ETSI TS 101 154 [29].</p> <p>The following clauses of ETSI TS 101 154 [29] are relevant to this specification:</p> <ul style="list-style-type: none"> <li>• 5.1; 25Hz MPEG-2 SDTV IRDs and Bitstreams</li> <li>• 5.5; Specifications Common to all H.264/AVC IRDs and Bitstreams</li> <li>• 5.6; H.264/AVC SDTV IRDs and Bitstreams. The minimum profile requirements for Nordig ID for SDTV content is High Profile at Level 3.0</li> <li>• 5.7.1 and 5.7.2; H.264/AVC HDTV IRDs and Bitstreams, The minimum profile</li> </ul>

	requirements for Nordig ID for HDTV content is High Profile at Level 4.0		
<b>IRD Profile(s)</b>	Basic, IRD, FE		
<b>Test procedure</b>	This is a general requirement. It will be verified in the following tests		
<b>Date</b>		<b>Sign</b>	

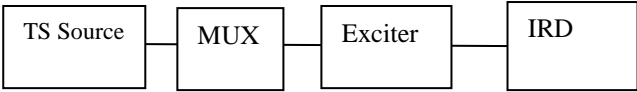
<b>Test Case</b>	<b>Task 6:2 Video Decoder – Resolutions and Frame rates</b>																																																																																								
<b>Section</b>	NorDig Unified 5.2																																																																																								
<b>Requirement</b>	The Video Decoder shall (1) be able to receive and decode the video formats specified in Table 5.1.																																																																																								
<b>IRD Profile(s)</b>	Basic, IRD, FE																																																																																								
<b>Test procedure</b>	<p><b>Purpose of test:</b> To verify that all video luminance resolutions and frame rates are displayed correctly.</p> <p><b>Equipment:</b></p> <div style="text-align: center;">  <pre> graph LR     A[TS Source] --&gt; B[MUX]     B --&gt; C[Exciter]     C --&gt; D[IRD]             </pre> </div> <p>Source must have TS containing all the video formats listed in test results.</p> <p><b>Test procedure:</b></p> <ol style="list-style-type: none"> <li>1. Play streams that contain all video formats in measurement record table below</li> <li>2. Tune to services</li> <li>3. Verify that the services are decoded and displayed correctly</li> <li>4. Fill in test results</li> </ol> <p><b>Expected result:</b></p> <p>Verify that the video is decoded and displayed correctly.</p>																																																																																								
<b>Test result(s)</b>	<p>Measurement record:</p> <table border="1" style="width: 100%; border-collapse: collapse;"> <thead> <tr> <th>Video Luminance Resolutions Horizontal x Vertical,</th> <th>Frame rate [Hz]</th> <th>I/P</th> <th>Frame Aspect Ratio (Horizontal : Vertical)</th> <th>Bit Stream (Profile@ Level)</th> <th>OK/ NOK</th> </tr> </thead> <tbody> <tr><td>352x288</td><td>25</td><td>I</td><td>4:3</td><td>MPEG-2 MP@ML</td><td></td></tr> <tr><td>352x288</td><td>25</td><td>I</td><td>16:9</td><td>MPEG-2 MP@ML</td><td></td></tr> <tr><td>352x288</td><td>25</td><td>I</td><td>4:3</td><td>AVC HP@L3</td><td></td></tr> <tr><td>352x288</td><td>25</td><td>I</td><td>16:9</td><td>AVC HP@L3</td><td></td></tr> <tr><td>352x576</td><td>25</td><td>I</td><td>4:3</td><td>MPEG-2 MP@ML</td><td></td></tr> <tr><td>352x576</td><td>25</td><td>I</td><td>16:9</td><td>MPEG-2 MP@ML</td><td></td></tr> <tr><td>352x576</td><td>25</td><td>I</td><td>4:3</td><td>AVC HP@L3</td><td></td></tr> <tr><td>352x576</td><td>25</td><td>I</td><td>16:9</td><td>AVC HP@L3</td><td></td></tr> <tr><td>480x576</td><td>25</td><td>I</td><td>4:3</td><td>MPEG-2 MP@ML</td><td></td></tr> <tr><td>480x576</td><td>25</td><td>I</td><td>16:9</td><td>MPEG-2 MP@ML</td><td></td></tr> <tr><td>480x576</td><td>25</td><td>I</td><td>4:3</td><td>AVC HP@L3</td><td></td></tr> <tr><td>480x576</td><td>25</td><td>I</td><td>16:9</td><td>AVC HP@L3</td><td></td></tr> <tr><td>544x576</td><td>25</td><td>I</td><td>4:3</td><td>MPEG-2 MP@ML</td><td></td></tr> </tbody> </table>					Video Luminance Resolutions Horizontal x Vertical,	Frame rate [Hz]	I/P	Frame Aspect Ratio (Horizontal : Vertical)	Bit Stream (Profile@ Level)	OK/ NOK	352x288	25	I	4:3	MPEG-2 MP@ML		352x288	25	I	16:9	MPEG-2 MP@ML		352x288	25	I	4:3	AVC HP@L3		352x288	25	I	16:9	AVC HP@L3		352x576	25	I	4:3	MPEG-2 MP@ML		352x576	25	I	16:9	MPEG-2 MP@ML		352x576	25	I	4:3	AVC HP@L3		352x576	25	I	16:9	AVC HP@L3		480x576	25	I	4:3	MPEG-2 MP@ML		480x576	25	I	16:9	MPEG-2 MP@ML		480x576	25	I	4:3	AVC HP@L3		480x576	25	I	16:9	AVC HP@L3		544x576	25	I	4:3	MPEG-2 MP@ML	
Video Luminance Resolutions Horizontal x Vertical,	Frame rate [Hz]	I/P	Frame Aspect Ratio (Horizontal : Vertical)	Bit Stream (Profile@ Level)	OK/ NOK																																																																																				
352x288	25	I	4:3	MPEG-2 MP@ML																																																																																					
352x288	25	I	16:9	MPEG-2 MP@ML																																																																																					
352x288	25	I	4:3	AVC HP@L3																																																																																					
352x288	25	I	16:9	AVC HP@L3																																																																																					
352x576	25	I	4:3	MPEG-2 MP@ML																																																																																					
352x576	25	I	16:9	MPEG-2 MP@ML																																																																																					
352x576	25	I	4:3	AVC HP@L3																																																																																					
352x576	25	I	16:9	AVC HP@L3																																																																																					
480x576	25	I	4:3	MPEG-2 MP@ML																																																																																					
480x576	25	I	16:9	MPEG-2 MP@ML																																																																																					
480x576	25	I	4:3	AVC HP@L3																																																																																					
480x576	25	I	16:9	AVC HP@L3																																																																																					
544x576	25	I	4:3	MPEG-2 MP@ML																																																																																					

	544x576	25	I	16:9	MPEG-2 MP@ML	
	544x576	25	I	4:3	AVC HP@L3	
	544x576	25	I	16:9	AVC HP@L3	
	720x576	25	I	4:3	MPEG-2 MP@ML	
	720x576	25	I	16:9	MPEG-2 MP@ML	
	720x576	25	I	4:3	AVC HP@L3	
	720x576	25	I	16:9	AVC HP@L3	
	640x720	50	P	16:9	AVC HP@L4	
	960x720	50	P	16:9	AVC HP@L4	
	1280x720	50	P	16:9	AVC HP@L4	
	960x1080	25	I	16:9	AVC HP@L4	
	960x1080	25	P	16:9	AVC HP@L4	
	1280x1080	25	I	16:9	AVC HP@L4	
	1280x1080	25	P	16:9	AVC HP@L4	
	1440x1080	25	I	16:9	AVC HP@L4	
	1440x1080	25	P	16:9	AVC HP@L4	
	1920x1080	25	I	16:9	AVC HP@L4	
	1920x1080	25	P	16:9	AVC HP@L4	
<b>Conformity</b>	<input type="checkbox"/> OK <input type="checkbox"/> Fault <input type="checkbox"/> Major <input type="checkbox"/> Minor, define fail reason in comments					
<b>Comments</b>	If possible describe if fault can be fixed with software update: <input type="checkbox"/> YES <input type="checkbox"/> NO Describe more specific faults and/or other information					
<b>Date</b>				<b>Sign</b>		

<b>Test Case</b>	<b>Task 6:3 Up-sampling/Up-conversion</b>
<b>Section</b>	NorDig Unified 5.3
<b>Requirement</b>	<p>When up-converting video with an encoded luminance resolution of 720x576 or 704x576 to any 1:1 pixel aspect ratio format (i.e. 1280x720 or 1920x1080), only the centred 702 of the horizontal 720 / 704 pixels shall be used. Those 702 pixels correspond to the 52 microseconds of an active line, hence preserves correct geometry in the up-conversion process.</p> <p>When up-converting other valid input line resolution format to any 1:1 pixel aspect (output) format (i.e. 1280x720 or 1920x1080), only the centred horizontal pixels shall be used; e.g. when up-converting (received) 544x576 line resolution format to any 1:1 pixel aspect ratio (output) format, only the centred 530 pixels of the horizontal 544 shall be used.</p>
<b>IRD Profile(s)</b>	Basic, IRD, FE
<b>Test procedure</b>	<p><b>Purpose of test:</b> When up-converting valid input line resolution format to any 1:1 pixel aspect (output) format, only the centered horizontal pixels shall be used.</p> <p><b>Equipment:</b></p>

			
	<p>Transport stream containing:</p> <ul style="list-style-type: none"> <li>• 720 x 576 video signal</li> <li>• 704x576 video signal</li> <li>• 544x576 video signal</li> </ul> <p><b>Test procedure:</b></p> <p>Verify that only the centred horizontal pixels shall be used for up-converting valid input line resolution to 1:1 pixel output (1920x1080, 1280x720). This is 702 horizontal pixels from 720/704x576 material and 530 pixels from 544x576 material.</p> <p><b>Expected result:</b></p> <p>When up-converting video with an encoded luminance resolution to any 1:1 pixel aspect ratio format , only the centred horizontal pixels shall be used. The geometry of the original picture shall be preserved.</p>		
<b>Test result(s)</b>			
<b>Conformity</b>	<input type="checkbox"/> <b>OK Fault</b> <input type="checkbox"/> Major <input type="checkbox"/> Minor, define fail reason in comments		
<b>Comments</b>	<p>If possible describe if fault can be fixed with software update: <input type="checkbox"/> <b>YES</b> <input type="checkbox"/> <b>NO</b></p> <p>Describe more specific faults and/or other information</p>		
<b>Date</b>		<b>Sign</b>	

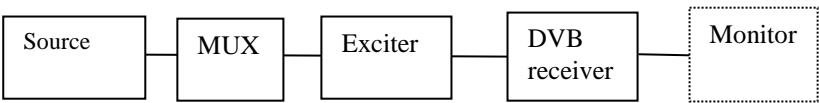
<b>Test Case</b>	<b>Task 6:4 Video Decoder - Colorimetry</b>
<b>Section</b>	NorDig Unified 5.4
<b>Requirement</b>	<p>The Decoder Format Converter shall use the VUI (Video Usability Information) parameters (ISO/IEC 14496-10)[56] colour primaries, transfer_characteristics and matrix_coefficients in received AVC encoded bitstreams and the Sequence Display Extension parameters (ISO/IEC 13818-2) [53] in MPEG-2 encoded bitstreams.</p> <p>The “Decoder Composition Output” shall output video with colour parameters targeting an ideal display, optimised for each video format.</p>
<b>IRD Profile(s)</b>	Basic, IRD, FE
<b>Test procedure</b>	<p><b>Purpose of test:</b></p> <p>To verify that the IRD is able to output video with colour parameters targeting an ideal display, optimised for each video format.</p> <p><b>Equipment:</b></p>  <p><b>Test procedure:</b></p> <p><b>TBD</b></p> <p><b>Expected result:</b></p> <p>The IRD is able to output video with colour parameters targeting an ideal display, optimised for each video format.</p>





<b>Test result(s)</b>	
<b>Conformity</b>	<input type="checkbox"/> OK Fault <input type="checkbox"/> Major <input type="checkbox"/> Minor, define fail reason in comments
<b>Comments</b>	If possible describe if fault can be fixed with software update: <input type="checkbox"/> YES <input type="checkbox"/> NO Describe more specific faults and/or other information
<b>Date</b>	<b>Sign</b>

<b>Test Case</b>	<b>Task 6:5 Video Decoder - Dynamic changes in video stream</b>
<b>Section</b>	NorDig Unified 5.5
<b>Requirement</b>	The NorDig IRD shall be able to handle dynamic changes in transmission between different video formats and frame rates (e.g 720p50 to 1080i25/1080p25 and 576i25 to 720p50), including changes in encoded sub resolution (e.g. 720x576 to 544x576) within one second after receiving Random Access Point. (Random Access Point equals AVC RAP for H.264/AVC and Sequence header for MPEG-2). The Nordic IRD shall adapt to changes in transmitted aspect ratio (e.g. 16:9 / 4:3) within one second after the reception. The transition shall cause minimal disturbance of the decoded service.
<b>IRD Profile(s)</b>	Basic, IRD, FE
<b>Test procedure</b>	<p><b>Purpose of test:</b> To verify that the receiver is able to handle dynamic changes in transmission between different video modes.</p> <p><b>Equipment:</b></p> <pre> graph LR     Source[Source] --- MUX[MUX]     MUX --- Exciter[Exciter]     Exciter --- DVB[DVB receiver]     DVB --- Monitor[Monitor]     style Monitor stroke-dasharray: 5 5   </pre> <p>Transport stream containing services with following video content and transitions between them:</p> <ul style="list-style-type: none"> <li>• MPEG-4 AVC HP@L3 576i 25Hz</li> <li>• MPEG-4 AVC HP@L4720p 50Hz</li> <li>• MPEG-4 AVC HP@L41080i 25Hz</li> <li>• MPEG-2 MP@ML 576i 25Hz</li> </ul> <p><b>Test procedure:</b> Tune to the service and verify that the transitions between encoding modes are reasonably smooth and that the decoding is resumed after a transition within</p> <ul style="list-style-type: none"> <li>• Five seconds in case of codec change.</li> <li>• One second in case of resolution chance.</li> </ul> <p>.. Fill in result to test results table below.</p> <p><b>Expected result:</b> The IRD is able to handle mode changes.</p>



<b>Test result(s)</b>	<b>From</b>	<b>To</b>	<b>OK/NOK</b>
	MPEG-4 AVC HP@L3 576i 25Hz 4:3	MPEG-4 AVC HP@L4720p 50Hz	
	MPEG-4 AVC HP@L4720p 50Hz	MPEG-4 AVC HP@L3 576i 25Hz 4:3	
	MPEG-4 AVC HP@L4720p 50Hz	MPEG-4 AVC HP@L41080i 25Hz	
	MPEG-4 AVC HP@L41080i 25Hz	MPEG-4 AVC HP@L4720p 50Hz	
	MPEG-4 AVC HP@L41080i 25Hz	MPEG-4 AVC HP@L3 576i 25Hz 4:3	
	MPEG-4 AVC HP@L3 576i 25Hz 4:3	MPEG-4 AVC HP@L41080i 25Hz	
	MPEG-2 MP@ML 576i 25Hz 4:3	MPEG-4 AVC HP@L4720p 50Hz	
	MPEG-4 AVC HP@L4720p 50Hz	MPEG-2 MP@ML 576i 25Hz 4:3	
	<b>Conformity</b>	<input type="checkbox"/> <b>OK</b> <input type="checkbox"/> <b>Fault</b> <input type="checkbox"/> Major <input type="checkbox"/> Minor, define fail reason in comments	
<b>Comments</b>	If possible describe if fault can be fixed with software update: <input type="checkbox"/> <b>YES</b> <input type="checkbox"/> <b>NO</b> Describe more specific faults and/or other information		
<b>Date</b>		<b>Sign</b>	

<b>Test Case</b>	<b>Task 6:6 Video Decoder - AVC still picture</b>
<b>Section</b>	NorDig Unified 5.6
<b>Requirement</b>	<p>By still picture means broadcast of only intra coded frames at very low frame rate (typical 1 frame per second). The NorDig IRD shall decode this still picture frame and repeat displaying this until next (still picture) frame is available to display.</p> <p>The NorDig IRD shall support still picture for the h.264/AVC profiles main and high.</p> <p>For the signalling of the AVC still picture the AVC video-descriptor will be used (in PMT) as specified in MPEG-2 Systems (ISO/IEC 13818-1 [54] and TS 101154 v1.10.1 [29]). The flag AVC_still_present will be set to 1.</p>
<b>IRD Profile(s)</b>	Basic, IRD, FE

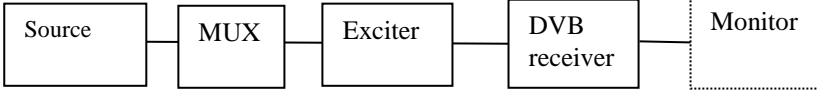
<b>Test procedure</b>	<p><b>Purpose of test:</b> To verify that the receiver is able to decode AVC still pictures.</p> <p><b>Equipment:</b></p> <div style="text-align: center;">  <pre> graph LR     Source[Source] --- MUX[MUX]     MUX --- Exciter[Exciter]     Exciter --- DVB[DVB receiver]     DVB --- Monitor[Monitor]             </pre> </div> <p>Transport stream with AVC still pictures and an IRD. The bitrate of AVC still picture stream is 100 kbit/s.</p> <p>Use following resolutions in the test stream(s):</p> <ul style="list-style-type: none"> <li>• 720x576 HP@L3</li> <li>• 1280x720 HP@L4</li> <li>• 1920x1080 HP@L4</li> </ul> <p>According to requirement still pictures are typically broadcasted at 1 frame/s. This can be initially difficult to achieve for given resolutions in bit rates down to 100 kbit/s.</p> <p><b>Test procedure:</b></p> <p>Tune to the service(s) and verify that the IRD decodes AVC still pictures correctly.</p> <p>If the 100kbit/s bit rate is not achieved, the tested bit rate shall be noted in comments.</p> <p><b>Expected result:</b></p> <p>The IRD is able to decode AVC still pictures at the bitrate of 100 kbit/s.</p>
<b>Test result(s)</b>	
<b>Conformity</b>	<input type="checkbox"/> <b>OK</b> <input type="checkbox"/> <b>Fault</b> <input type="checkbox"/> Major <input type="checkbox"/> Minor, define fail reason in comments
<b>Comments</b>	If possible describe if fault can be fixed with software update: <input type="checkbox"/> <b>YES</b> <input type="checkbox"/> <b>NO</b> Describe more specific faults and/or other information
<b>Date</b>	<b>Sign</b>

<b>Test Case</b>	<b>Task 6:7 Minimum video bandwidth</b>
<b>Section</b>	NorDig Unified 5.7
<b>Requirement</b>	<p>The NorDig IRD shall provide support for very low bandwidth video.</p> <p>For MPEG-2 video the decoder shall be able to decode at bit rates down to 1.0 Mbps for video resolutions up to full Standard Definition resolution video (720x576).</p> <p>The NorDig IRD shall be able to decode H.264/AVC video at bitrates down to 250 kbps for all resolutions up to 1920x1080. For AVC still picture the NorDig IRD shall be able to decode down to 100 kbps.</p>
<b>IRD Profile(s)</b>	Basic, IRD, FE

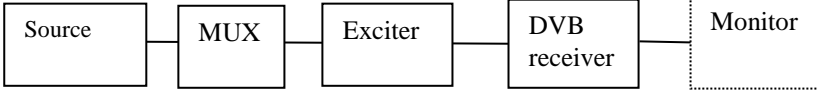
<b>Test procedure</b>	<p><b>Purpose of test:</b> To verify that the receiver is able to decode video streams for very low bandwidth video.</p> <p><b>Equipment:</b></p> <div style="text-align: center;">  <pre> graph LR     Source[Source] --- MUX[MUX]     MUX --- Exciter[Exciter]     Exciter --- DVB[DVB receiver]     DVB --- Monitor[Monitor]     style Monitor stroke-dasharray: 5 5             </pre> </div> <p>A transport stream with following video content at:</p> <ul style="list-style-type: none"> <li>• MPEG-2 MP@ML 720x576i 25Hz 1.0 Mbps</li> <li>• MPEG-4 AVC HP@L3 720x576i 25Hz 250 kbps</li> <li>• MPEG-4 AVC HP@L4 1280x720p 50Hz 250 kbps</li> <li>• MPEG-4 AVC HP@L4 1920x1080i 25Hz 250 kbps</li> </ul> <p><b>Test procedure:</b></p> <p>Tune to the service(s) and verify that the IRD decodes very low bandwidth video correctly.</p> <p>If the 250kbit/s bit rate is not achieved, the tested bit rate shall be noted in comments.</p> <p><b>Expected result:</b></p> <p>The IRD supports low bitrate video as stipulated above..</p>
<b>Test result(s)</b>	
<b>Conformity</b>	<input type="checkbox"/> OK <input type="checkbox"/> Fault <input type="checkbox"/> Major <input type="checkbox"/> Minor, define fail reason in comments
<b>Comments</b>	<p>If possible describe if fault can be fixed with software update: <input type="checkbox"/> YES <input type="checkbox"/> NO</p> <p>Describe more specific faults and/or other information</p>
<b>Date</b>	<b>Sign</b>

<b>Test Case</b>	<b>Task 6:8 Frame cropping</b>
<b>Section</b>	NorDig Unified 5.8
<b>Requirement</b>	<p>The NorDig IRD shall support frame cropping for H.264/AVC encoded video. Frame cropping signalling is used to indicate which area of the encoded video that should be displayed.</p> <p>For 1080 line formats, the video is encoded with 1088 lines. To indicate which area of the encoded video that should be displayed, frame cropping signalling may be used. If frame cropping information is included in the encoded video, this shall be used to decide which 8 lines should be hidden in the Decoder Composition Output. If no frame cropping signalling is available, the IRD shall crop the bottom 8 lines.</p>
<b>IRD Profile(s)</b>	Basic, IRD, FE
<b>Test procedure</b>	<p><b>Purpose of test:</b> To verify that the receiver support frame cropping.</p> <p><b>Equipment:</b></p>

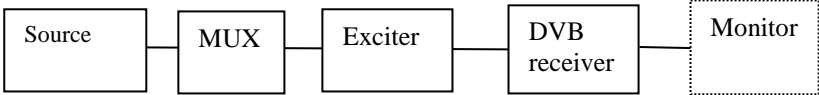
		
	<p>TS containing a service with frame cropping signalling for 8 lines (1080i) and a service without frame cropping (1080i).</p> <p><b>Test procedure:</b></p> <ol style="list-style-type: none"> <li>1. Play out the transport stream containing a service with frame cropping information and another service without frame cropping information.</li> <li>2. Verify that the desired lines are cropped.</li> <li>3. Change to service without frame cropping information.</li> <li>4. Verify that the bottom 8 lines are cropped.</li> <li>5. Fill in test results</li> </ol> <p><b>Expected result:</b></p> <p>The IRD supports frame cropping correctly</p>	
<b>Test result(s)</b>		
<b>Conformity</b>	<input type="checkbox"/> <b>OK</b> <input type="checkbox"/> <b>Fault</b> <input type="checkbox"/> Major <input type="checkbox"/> Minor, define fail reason in comments	
<b>Comments</b>	<p>If possible describe if fault can be fixed with software update: <input type="checkbox"/> <b>YES</b> <input type="checkbox"/> <b>NO</b></p> <p>Describe more specific faults and/or other information</p>	
<b>Date</b>		<b>Sign</b>

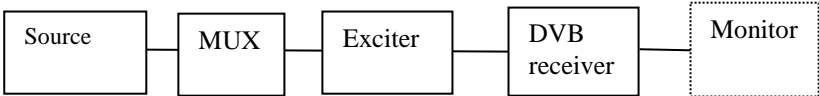
<b>Test Case</b>	<b>Task 6:9 Overscan</b>
<b>Section</b>	NorDig Unified 5.9
<b>Requirement</b>	For services carrying H.264/AVC video, the broadcaster may use the overscan_info_present and overscan_appropriate flags to indicate whether the receiver should apply this typical overscan or should display the complete broadcast video image. The flags will be encoded according to Table 5.3.
<b>IRD Profile(s)</b>	Basic, IRD, FE
<b>Test procedure</b>	<p><b>Purpose of test:</b></p> <p>To verify that the receiver support overscan.</p> <p><b>Equipment:</b></p> <div style="text-align: center;">  </div> <p>TS containing a service with overscan signaling and a service without overscan.</p> <p><b>Test procedure:</b></p> <ol style="list-style-type: none"> <li>1. Play out the transport stream containing a service with overscan information and another service without overscan information.</li> <li>2. Verify that the desired behavior of the IRD happens.</li> <li>3. Change to service without overscan information.</li> <li>4. Verify that the desired behavior of the IRD happens.</li> <li>5. Fill in test results</li> </ol>

	<b>Expected result:</b> The IRD supports overscan correctly
<b>Test result(s)</b>	
<b>Conformity</b>	<input type="checkbox"/> OK Fault <input type="checkbox"/> Major <input type="checkbox"/> Minor, define fail reason in comments
<b>Comments</b>	If possible describe if fault can be fixed with software update: <input type="checkbox"/> YES <input type="checkbox"/> NO Describe more specific faults and/or other information
<b>Date</b>	<b>Sign</b>

<b>Test Case</b>	<b>Task 6:10 High Definition Video Output and Display</b>
<b>Section</b>	NorDig Unified 5.10
<b>Requirement</b>	The NorDig STBs shall be able to use the EDID information provided by the display to determine automatically the STB output and to accept a manual setting of the STB output, as specified in section 8.6.  For NorDig iDTVs the output video shall always be converted to the display's native resolution.
<b>IRD Profile(s)</b>	Basic, IRD, FE
<b>Test procedure</b>	<b>This requirement is tested in test case Task 9:4.</b>

<b>Test Case</b>	<b>Task 6:11 Down-conversion of High Definition Video for Standard Definition output</b>
<b>Section</b>	NorDig Unified 5.11
<b>Requirement</b>	If SCART, or any other analogue video output (Y, P <sub>b</sub> , P <sub>r</sub> , RF-PAL or CVBS) is available, the decoded High Definition video shall be down-converted by the SD Format Converter to Standard Definition resolution for output via these interfaces.  Down-conversion of pictures shall be implemented, from any of the incoming encoded HD full screen luminance resolution values (1920x1080, 1440x1080, 1280x1080, 960x1080, 1280x720, 960x720 and 640x720) to SD resolution (720x576).  When down-converting any 1:1 pixel aspect ratio format (i.e. 1280x720 or 1920x1080) in the Decoder Composition Output to 720x576 resolution, the target shall be 702x576 pixels to be centered in the 720x576 grid with nine black pixels inserted as the start of the 720 pixel active line and nine pixels inserted as the end of the 720 pixel active line.  Down-converted HD video shall be displayed as 16:9 letterbox on 4:3 displays. (Allowing center cut would limit the safe area to 4:3 for HD production, hence <i>not</i> an allowed display option).  The SD Format Converter should apply appropriate re-interlacing (field mode integration re-interlacing). It shall process and output 720x576i25 in 4:3 frame aspect ratio or 16:9 frame aspect ratio video with colours according to 5.4 Colormertry.
<b>IRD Profile(s)</b>	Basic, IRD, FE

<b>Test procedure</b>	<b>This requirement is tested in test Task 9:8</b>
-----------------------	----------------------------------------------------

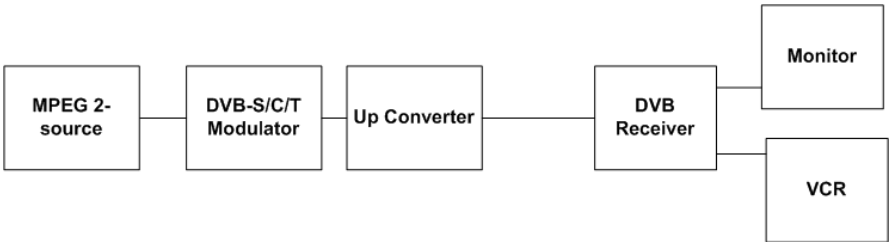
<b>Test Case</b>	<b>Task 6:12 16:9 displayed on 4:3 monitors</b>
<b>Section</b>	NorDig Unified 5.12
<b>Requirement</b>	The Nordig IRDs shall have methods to display 16:9 transmitted content on a 4:3 monitor. Likewise Nordig IRDs and iDTVs shall have methods to display 4:3 transmitted content on a 16:9 monitor. The user shall have the ability to select appropriate aspect ratio for the analogue video output (SCART), see section 8.4.
<b>IRD Profile(s)</b>	Basic, IRD, FE
<b>Test procedure</b>	<p><b>Purpose of test:</b> To verify that the IRD can output suitable picture signals for the 4:3 screen.</p> <p>This test is not relevant for iDTV or PC based receivers in case the video is decoded to the integrated screen.</p> <p>For STBs or similar receivers with an external analog video output e.g. Y, P<sub>b</sub>, P<sub>r</sub>, RF-PAL, Y/C or CVBS, it is recommended the video aspect ratio can be re-formatted from 16:9 to 4:3 if so selected by the user. If the video signal is available on a SCART connector, the aspect ratio shall be signaled via pin 8 in the SCART connector, see test Task 7:2. Line 23 and line 623 should be masked before the letterbox conversion to avoid the irritating half lines.</p> <p><b>Test Equipment:</b> Test signals are created using the test bed shown below:</p>  <pre> graph LR     A[MPEG 2-source] --- B[DVB-S/C/T Modulator]     B --- C[Up Converter]     C --- D[DVB Receiver]     D --- E[Monitor]     D --- F[VCR]   </pre> <p>The multiplex should contain a number of services with 4:3 picture aspect ratio, and one service with 16:9 aspect ratio. All services in the multiplex are descrambled before recording.</p> <p><b>Test procedure:</b> The IRD is tuned to a transport stream which contains a 16:9 aspect ratio video service. It is verified that the receiver can deliver a picture with the maintained 16:9 aspect ratio (Letterbox)</p> <p><b>Expected result:</b> Receiver can deliver a picture with the maintained 16:9 aspect ratio (Letterbox) on its external analog video output.</p> <p>Note: During the transition period from 4:3 to pure 16:9 transmissions, dynamical changes of the aspect ratio, e.g. 16:9 -&gt; 4:3 -&gt; 16:9, may occur in broadcasting. It is highly recommended that IRD can provide always correct aspect ratio.</p>
<b>Test result(s)</b>	
<b>Conformity</b>	<input type="checkbox"/> <b>OK Fault</b> <input type="checkbox"/> Major <input type="checkbox"/> Minor, define fail reason in comments
<b>Comments</b>	If possible describe if fault can be fixed with software update: <input type="checkbox"/> <b>YES</b> <input type="checkbox"/> <b>NO</b>

	Describe more specific faults and/or other information
<i>Date</i>	<i>Sign</i>

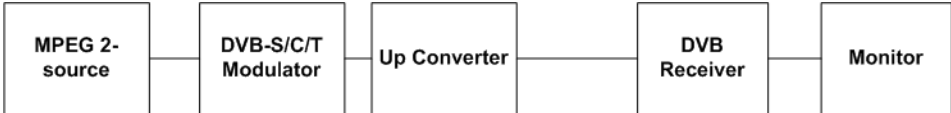
<i>Test Case</i>	<b>Task 6:13 Displaying 4:3 Material on 16:9 Monitors</b>
<i>Section</i>	NorDig Unified 5.12
<i>Requirement</i>	The Nordig IRDs shall have methods to display 16:9 transmitted content on a 4:3 monitor. Likewise Nordig IRDs and iDTVs shall have methods to display 4:3 transmitted content on a 16:9 monitor. The user shall have the ability to select appropriate aspect ratio for the analogue video output (SCART), see section 8.4.
<i>IRD Profile(s)</i>	Basic, IRD, FE
<i>Test procedure</i>	<p><b>Purpose of test:</b> To verify that the IRD can output suitable picture signals for the 16:9 screen.</p> <p><b>Equipment:</b> Test signals are created using the test bed shown below:</p> <div style="text-align: center;">  <pre> graph LR     A[MPEG 2-source] --&gt; B[DVB-S/C/T Modulator]     B --&gt; C[Up Converter]     C --&gt; D[DVB Receiver]     D --&gt; E[Monitor]             </pre> </div> <p><b>Test procedure:</b> This test can be done in parallel with Task 9:2. The IRD is tuned to a transport stream containing a 4:3 aspect ratio video service. It is verified that the receiver can deliver a maintained full height 4:3 aspect ratio (Pillarbox) video signal for the 16:9 screen.</p> <p><b>Expected result:</b> Receiver can deliver a maintained full height 4:3 aspect ratio (Pillarbox) video signal for the 16:9 screen. Note: During the transition period from 4:3 to pure 16:9 transmissions, dynamical changes of the aspect ratio, e.g. 16:9 -&gt; 4:3 -&gt; 16:9, may occur in broadcasting. It is highly recommended that IRD can provide always correct aspect ratio.</p>
<i>Test result(s)</i>	
<i>Conformity</i>	<input type="checkbox"/> OK Fault <input type="checkbox"/> Major <input type="checkbox"/> Minor, define fail reason in comments
<i>Comments</i>	If possible describe if fault can be fixed with software update: <input type="checkbox"/> YES <input type="checkbox"/> NO Describe more specific faults and/or other information
<i>Date</i>	<i>Sign</i>

<i>Test Case</i>	<b>Task 6:14 Rescaling for HbbTV application</b>
<i>Section</i>	NorDig Unified 5.13
<i>Requirement</i>	A NorDig Hybrid shall support rescaling as defined in HbbTV under “video scaling” in clause 10.2.1 of ETSI TS 102 796 V1.2.1. These shall be supported for any of the valid





	incoming encoded full screen luminance resolution (see 5.2 for full screen luminance resolution values). The video shall be scaled, preserving the aspect ratio, such that all of the decoded video is visible within the area of the AV Control object. (See HbbTV requirements in ETSI TS 102 796 Appendix E4).
<b>IRD Profile(s)</b>	Hybrid, IRD, FE
<b>Test procedure</b>	<b>This requirement is tested in test Task 16:</b>

## 2.7 Task 7: Audio

<b>Test Case</b>	<b>Task 7:1 Audio User Preference Settings</b>	
<b>Section</b>	NorDig Unified 6.1.1	
<b>Requirement</b>	The NorDig IRD shall have User Preference Settings for audio functions as stated in section 16.2 (for example primary and secondary audio language, audio format, audio type, audio delay, etc).	
<b>IRD Profile(s)</b>	Basic, IRD, FE	
<b>Test procedure</b>	This is general requirement that will be test in following tests.	
<b>Test result(s)</b>		
<b>Conformity</b>	<input type="checkbox"/> <b>OK Fault</b> <input type="checkbox"/> Major <input type="checkbox"/> Minor, define fail reason in comments	
<b>Comments</b>	If possible describe if fault can be fixed with software update: <input type="checkbox"/> <b>YES</b> <input type="checkbox"/> <b>NO</b> Describe more specific faults and/or other information	
<b>Date</b>		<b>Sign</b>

<b>Test Case</b>	<b>Task 7:2 MPEG-1 Layer II: Requirements</b>	
<b>Section</b>	NorDig Unified 6.2.1.1	
<b>Requirement</b>	The NorDig IRD shall support: <ul style="list-style-type: none"> <li>• decode MPEG-1 Layer II streams at all bit rates and sample rates listed in ETSI TS 101 154 [29].</li> </ul> The NorDig IRD should support: <ul style="list-style-type: none"> <li>• decode MPEG-1 Layer II streams at half-sampling rates (22.05 and 24 kHz).</li> </ul>	
<b>IRD Profile(s)</b>	Basic, IRD, FE	
<b>Test procedure</b>	This is general requirement that will be test in following tests.	
<b>Test result(s)</b>		
<b>Conformity</b>	<input type="checkbox"/> <b>OK Fault</b> <input type="checkbox"/> Major <input type="checkbox"/> Minor, define fail reason in comments	
<b>Comments</b>	If possible describe if fault can be fixed with software update: <input type="checkbox"/> <b>YES</b> <input type="checkbox"/> <b>NO</b> Describe more specific faults and/or other information	
<b>Date</b>		<b>Sign</b>

<b>Test Case</b>	<b>Task 7:3 MPEG-1 Layer II: Analogue audio output</b>	
<b>Section</b>	NorDig Unified 6.2, 6.2.1.1	
<b>Requirement</b>	The NorDig IRD with SCART and/or analogue outputs shall always have an audio signal present on the analogue outputs (SCART and stereo out, see section 8.5 and to built-in loudspeakers (see note 1)) if any of the supported formats is received.  The NorDig IRD shall support:	

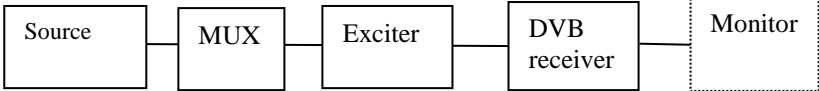
	<ul style="list-style-type: none"> <li>• decode MPEG-1 Layer II streams at all bit rates and sample rates listed in ETSI TS 101 154 [29].</li> </ul>
<b>IRD Profile(s)</b>	Basic, IRD, FE
<b>Test procedure</b>	<p><b>Purpose of test:</b> To verify that receiver decodes MPEG-1 Layer II streams at all bit rates and sample rates and audio level can be adjusted.</p> <p><b>Equipment:</b></p> <div style="text-align: center;">  <pre> graph LR     Source[Source] --- MUX[MUX]     MUX --- Exciter[Exciter]     Exciter --- DVB[DVB receiver]     DVB --- Monitor[Monitor]             </pre> </div> <p>A transport stream with following MPEG-1 Layer II audio content:</p> <ul style="list-style-type: none"> <li>• audio_mode = '0' (stereo), data rate = 192 kbit/s, at least one of the sampling frequencies: 32, 44.1 or 48 kHz</li> <li>• audio_mode = '1', '2' (dual channel), data rate = 192 kbit/s, at least one of the sampling frequencies: 32, 44.1 or 48 kHz</li> <li>• audio_mode = '3' (single channel), data rate: 96 kbit/s, sampling frequency: 48 kHz</li> </ul> <p><b>Test procedure:</b></p> <p>The IRD is tuned to a service containing all the combinations of the MPEG-1 Layer II audio parameters above.</p> <p>The audio level is adjusted in the audio output.</p> <p><b>Expected result:</b></p> <p>IRD supports MPEG-1 Layer II audio decoding and audio is available properly in analogue audio output(s).</p> <p>The audio output level can be adjusted.</p>
<b>Test result(s)</b>	
<b>Conformity</b>	<input type="checkbox"/> OK Fault <input type="checkbox"/> Major <input type="checkbox"/> Minor, define fail reason in comments
<b>Comments</b>	If possible describe if fault can be fixed with software update: <input type="checkbox"/> YES <input type="checkbox"/> NO Describe more specific faults and/or other information
<b>Date</b>	<b>Sign</b>

<b>Test Case</b>	<b>Task 7:4 MPEG-1 Layer II: HDMI output interface</b>
<b>Section</b>	NorDig Unified 6.2.1.2, 6.2.1.1
<b>Requirement</b>	<p>The NorDig IRD shall be capable of providing the following formats on the HDMI output connector from an MPEG-1 Layer II bitstream (see section 16 for factory default settings):</p> <ul style="list-style-type: none"> <li>• Decoded to PCM stereo bitstream.</li> </ul> <p>The NorDig IRD shall support:</p> <ul style="list-style-type: none"> <li>• decode MPEG-1 Layer II streams at all bit rates and sample rates listed in ETSI TS</li> </ul>

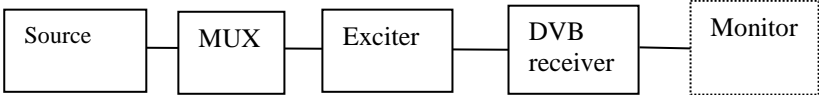
	101 154 [29].
<b>IRD Profile(s)</b>	Basic, IRD, FE
<b>Test procedure</b>	<p><b>Purpose of test:</b> To verify that receiver decodes MPEG-1 Layer II streams at all bit rates and sample rates to HDMI output interface and audio level can be adjusted.</p> <p>This test is mandatory for STBs and IDTVs supporting HDMI output or HDMI ARC.</p> <p><b>Equipment:</b></p> <div style="text-align: center;">  <pre> graph LR     Source[Source] --- MUX[MUX]     MUX --- Exciter[Exciter]     Exciter --- DVB[DVB receiver]     DVB --- Monitor[Monitor]             </pre> </div> <p>A transport stream with following MPEG-1 Layer II audio content:</p> <ul style="list-style-type: none"> <li>• audio_mode = '0' (stereo), data rate = 192 kbit/s, at least one of the sampling frequencies: 32, 44.1 or 48 kHz</li> <li>• audio_mode = '1', '2' (dual channel), data rate = 192 kbit/s, at least one of the sampling frequencies: 32, 44.1 or 48 kHz</li> <li>• audio_mode = '3' (single channel), data rate: 96 kbit/s, sampling frequency: 48 kHz</li> </ul> <p><b>Test procedure:</b></p> <p>The IRD is tuned to a service containing all the combinations of the MPEG-1 Layer II audio parameters above. This task can be done parallel with Task 7:2.</p> <p>The audio level is adjusted in the audio output.</p> <p><b>Expected result:</b></p> <p>IRD supports MPEG-1 Layer II audio decoding and audio is available properly in HDMI output in PCM stereo bit stream format independently of the user setting for stereo or multichannel.</p> <p>The audio output level can be adjusted.</p>
<b>Test result(s)</b>	
<b>Conformity</b>	<input type="checkbox"/> OK Fault <input type="checkbox"/> Major <input type="checkbox"/> Minor, define fail reason in comments
<b>Comments</b>	If possible describe if fault can be fixed with software update: <input type="checkbox"/> YES <input type="checkbox"/> NO Describe more specific faults and/or other information
<b>Date</b>	<b>Sign</b>

<b>Test Case</b>	<b>Task 7:5 MPEG-1 Layer II: S/PDIF output interface</b>
<b>Section</b>	NorDig Unified 6.2.1.2, 6.2.1.1
<b>Requirement</b>	<p>The NorDig IRD including an S/PDIF output shall be capable of providing the following formats on the S/PDIF connector from an MPEG-1 Layer II bitstream:</p> <ul style="list-style-type: none"> <li>• Decoded to PCM stereo bitstream</li> </ul> <p>The NorDig IRD shall support:</p> <ul style="list-style-type: none"> <li>• decode MPEG-1 Layer II streams at all bit rates and sample rates listed in ETSI TS 101 154 [29].</li> </ul>
<b>IRD Profile(s)</b>	Basic, IRD, FE

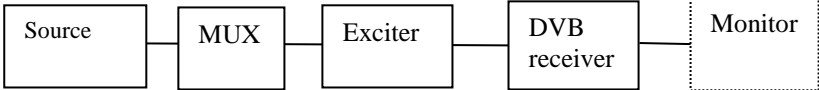
<b>Test procedure</b>	<p><b>Purpose of test:</b> To verify that receiver decodes MPEG-1 Layer II streams at all bit rates and sample rates to S/PDIF output interface.</p> <p><b>Equipment:</b></p> <div style="text-align: center;">  <pre> graph LR     Source[Source] --- MUX[MUX]     MUX --- Exciter[Exciter]     Exciter --- DVB[DVB receiver]     DVB --- Monitor[Monitor]             </pre> </div> <p>A transport stream with following MPEG-1 Layer II audio content:</p> <ul style="list-style-type: none"> <li>• audio_mode = '0' (stereo), data rate = 192 kbit/s, at least one of the sampling frequencies: 32, 44.1 or 48 kHz</li> <li>• audio_mode = '1', '2' (dual channel), data rate = 192 kbit/s, at least one of the sampling frequencies: 32, 44.1 or 48 kHz</li> <li>• audio_mode = '3' (single channel), data rate: 96 kbit/s, sampling frequency: 48 kHz</li> </ul> <p><b>Test procedure:</b></p> <p>The IRD is tuned to a service containing all the combinations of the MPEG-1 Layer II audio parameters above. This task can be done parallel with Task 7:2.</p> <p><b>Expected result:</b></p> <p>IRD supports MPEG-1 Layer II audio decoding and audio is available properly in S/PDIF output in PCM stereo bit stream format independently of the user setting for stereo or multichannel.</p>
<b>Test result(s)</b>	
<b>Conformity</b>	<input type="checkbox"/> OK <input type="checkbox"/> Fault <input type="checkbox"/> Major <input type="checkbox"/> Minor, define fail reason in comments
<b>Comments</b>	If possible describe if fault can be fixed with software update: <input type="checkbox"/> YES <input type="checkbox"/> NO Describe more specific faults and/or other information
<b>Date</b>	<b>Sign</b>

<b>Test Case</b>	<b>Task 7:6 AC-3: Requirements</b>
<b>Section</b>	NorDig Unified 6.2.2
<b>Requirement</b>	<p>NorDig IRD supporting E-AC-3 and AC-3 shall</p> <ul style="list-style-type: none"> <li>• decode AC-3 streams at all bit rates and sample rates listed in ETSI TS 102 366 [35] (not including Annex E).</li> <li>• (additionally) decode E-AC-3 streams with data rates from 32 kbps to 3 024 kbps and support all sample rates listed in TS 102 366 [35] Annex E.</li> <li>• be capable of transcoding E-AC-3 bitstreams to AC-3 bitstreams according to TS 102 366 [35]. Transcoding to AC-3 audio streams shall be at a fixed bit rate of 640 kbps.</li> </ul>
<b>IRD Profile(s)</b>	Basic, IRD, FE
<b>Test procedure</b>	<p><b>Purpose of test:</b> To verify that the IRD supports different AC-3 bit rates and sampling rates.</p> <p><b>Equipment:</b></p>

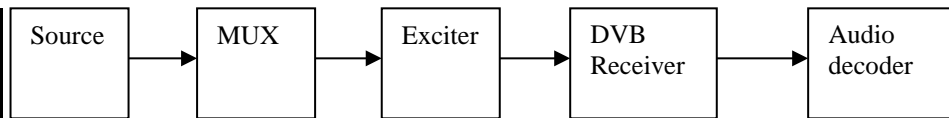

The TS shall contain services, which has

- a AC-3 (mono, stereo) audio component with relevant signaling at bit rates and sampling rates:
  - Sampling rates 32, 44,1 and 48 kHz
  - Bit rates 64, 192, 384 and 640 kbit/s
- a AC-3 (multichannel) audio component with relevant signaling at bit rates and sampling rates:
  - Sampling rates 32, 44,1 and 48 kHz
  - Bit rate 64, 192, 384 and 640 kbit/s

**Test procedure:**

1. Connect the IRD to an audio receiver, e.g. Home Theater System with HDMI.
2. Verify that service has a multichannel AC-3 audio available.
3. In receiver menu, select MPEGstereo audio.
4. Verify that AC-3 multichannel is decoded and downmixed to PCM stereo bitstream for HDMI output and if supported for HDMI ARC.
5. Verify the audio output level can be adjusted.
6. In receiver menu, select multichannel audio.
7. Verify that AC-3 multichannel is passed-through as native bitstream for HDMI output.
  
8. Verify that service has a stereo AC-3 audio available.
9. In receiver menu, select MPEGstereo audio.
10. Verify that AC-3 stereo is decoded and downmixed to PCM stereo bitstream for HDMI output and if supported for HDMI ARC.
11. Verify the audio output level can be adjusted.
12. In receiver menu, select multichannel audio.
13. Verify that AC-3 stereo is passed-through as native bitstream for HDMI output.

**Expected result:**

IRD supports for AC-3 input audio signal and down-mix to stereo.

**Test result(s)**

	Bit rate	Sampling rate	NOK or OK
mono			
stereo			
Multichannel 5.1			
Down-mix to stereo	N/A	N/A	

**Conformity**

OK  Fault  Major  Minor, define fail reason in comments

**Comments**

If possible describe if fault can be fixed with software update:  YES  NO  
Describe more specific faults and/or other information

**Date**

**Sign**

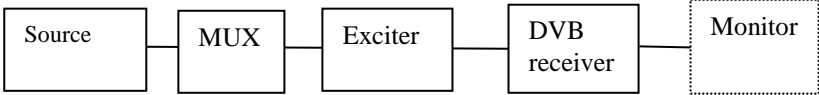
<b>Test Case</b>	<b>Task 7:7 AC-3: Analogue audio output</b>	
<b>Section</b>	NorDig Unified 6.2.2	
<b>Requirement</b>	<p>The NorDig IRD with SCART and/or analogue outputs shall always have an audio signal present on the analogue outputs (SCART and stereo out, see section 8.5 and to built-in loudspeakers (see note 1)) if any of the supported formats is received.</p> <p>If the NorDig IRD has analogue stereo output(s), it shall be capable of decoding and downmixing the supported audio formats for the analogue outputs.</p> <p>NorDig IRD supporting E-AC-3 and AC-3 shall</p> <ul style="list-style-type: none"> <li>• decode AC-3 streams at all bit rates and sample rates listed in ETSI TS 102 366 [36] (not including Annex E).</li> </ul>	
<b>IRD Profile(s)</b>	Basic, IRD, FE	
<b>Test procedure</b>	<p><b>Purpose of test:</b> To verify that receiver decodes AC-3 bitstream and audio output level can be adjusted.</p> <p>This test is only mandatory for STB or IDTV with SCART or analogue audio output interface.</p> <p><b>Equipment:</b></p> <div style="text-align: center;">  <pre> graph LR     Source[Source] --- MUX[MUX]     MUX --- Exciter[Exciter]     Exciter --- DVB[DVB receiver]     DVB --- Monitor[Monitor]     style Monitor stroke-dasharray: 5 5             </pre> </div> <p>A transport stream containing a service with AC-3 multichannel audio</p> <p><b>Test procedure:</b></p> <ol style="list-style-type: none"> <li>1. Verify that service has a multichannel AC-3 audio available.</li> <li>2. In receiver menu, select stereo audio.</li> <li>3. Verify that service containing AC-3 multichannel audio is downmixed to stereo at analog audio output.</li> <li>4. In receiver menu, select multichannel audio.</li> <li>5. Verify that AC-3 multichannel is downmixed to stereo at analog audio output.</li> <li>6. Verify it is possible to adjust audio output level.</li> </ol> <p><b>Expected result:</b></p> <p>IRD supports AC-3 audio decoding and audio is downmixed to stereo in analog audio output(s).</p> <p>The audio output level can be adjusted.</p>	
<b>Test result(s)</b>		
<b>Conformity</b>	<input type="checkbox"/> OK <input type="checkbox"/> Fault <input type="checkbox"/> Major <input type="checkbox"/> Minor, define fail reason in comments	
<b>Comments</b>	<p>If possible describe if fault can be fixed with software update: <input type="checkbox"/> YES <input type="checkbox"/> NO</p> <p>Describe more specific faults and/or other information</p>	
<b>Date</b>		<b>Sign</b>

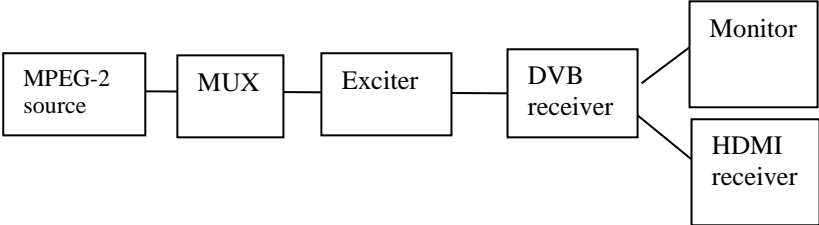
<b>Test Case</b>	<b>Task 7:8 AC-3: HDMI output and HDMI ARC interface</b>
<b>Section</b>	NorDig Unified 6.2.2
<b>Requirement</b>	<p>NorDig IRDs supporting E-AC-3 and AC-3 shall be capable of providing the following formats on the HDMI output connector connector from an E-AC-3 or AC-3 bitstream (see chapter 16 for factory default settings):</p> <ul style="list-style-type: none"> <li>• Pass-through of native bitstream (AC-3 and E-AC-3).</li> <li>• E-AC-3 bitstream transcoded to AC-3 bitstream.</li> <li>• Decoded and downmixed (if &gt; 2 channels) to PCM stereo bitstream</li> </ul> <p>NorDig IRD supporting E-AC-3 and AC-3 shall</p> <ul style="list-style-type: none"> <li>• decode AC-3 streams at all bit rates and sample rates listed in ETSI TS 102 366 [36] (not including Annex E).</li> </ul>
<b>IRD Profile(s)</b>	Basic, IRD, FE
<b>Test procedure</b>	<p><b>Purpose of test:</b> To verify that receiver decodes and passes-through AC-3 bitstream and the audio output level for decoded AC-3 bitstream can be adjusted.</p> <p>This test in only relevant for IRD with HDMI output or HDMI ARC.</p> <p><b>Equipment:</b></p>  <pre> graph LR     A[MPEG-2 source] --&gt; B[MUX]     B --&gt; C[Exciter]     C --&gt; D[DVB receiver]     D --&gt; E[Monitor]     D --&gt; F[HDMI receiver]   </pre> <p>A transport stream containing a service with AC-3 multichannel audio.</p> <p><b>Test procedure:</b></p> <ol style="list-style-type: none"> <li>1. Connect the IRD to an HDMI receiver, e.g. Home Theater System with HDMI.</li> <li>2. Verify that service has a multichannel AC-3 audio available.</li> <li>3. In receiver menu, select MPEG stereo audio.</li> <li>4. Verify that AC-3 multichannel is decoded and downmixed to PCM stereo bitstream for HDMI output and if supported for HDMI ARC.</li> <li>5. Verify the audio output level can be adjusted.</li> <li>6. In receiver menu, select multichannel audio.</li> <li>7. Verify that AC-3 multichannel is passed-through as native bitstream for HDMI output.</li> </ol> <p><b>Expected result:</b></p> <p>IRD supports AC-3 audio decoding and downmixing to PCM stereo when stereo audio is selected and the audio output level can be adjusted.</p> <p>IRD supports AC-3 audio pass-through native bitstream when multichannel audio is selected.</p>
<b>Test result(s)</b>	
<b>Conformity</b>	<input type="checkbox"/> OK Fault <input type="checkbox"/> Major <input type="checkbox"/> Minor, define fail reason in comments
<b>Comments</b>	If possible describe if fault can be fixed with software update: <input type="checkbox"/> YES <input type="checkbox"/> NO

	Describe more specific faults and/or other information		
<i>Date</i>		<i>Sign</i>	

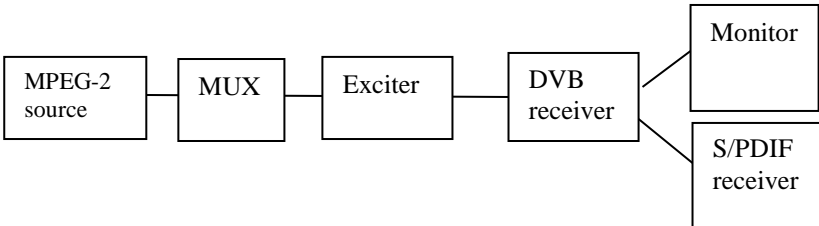
<b>Test Case</b>	<b>Task 7:9 AC-3: S/PDIF output interface</b>		
<b>Section</b>	NorDig Unified 6.2.2		
<b>Requirement</b>	<p>The NorDig IRD supporting E-AC-3 and AC-3 and including an S/PDIF output shall be capable of providing the following formats on the S/PDIF connector from an E-AC-3 or AC-3 bitstream:</p> <ul style="list-style-type: none"> <li>• E-AC-3 bitstream transcoded to AC-3 bitstream</li> <li>• Decoded and downmixed (if &gt; 2 channels) to PCM stereo bitstream</li> <li>• Pass-through of AC-3 bitstream</li> </ul> <p>NorDig IRD supporting E-AC-3 and AC-3 shall</p> <ul style="list-style-type: none"> <li>• decode AC-3 streams at all bit rates and sample rates listed in ETSI TS 102 366 [36] (not including Annex E).</li> </ul>		
<b>IRD Profile(s)</b>	Basic, IRD, FE		
<b>Test procedure</b>	<p><b>Purpose of test:</b> To verify that receiver decodes and passes-through AC-3 bitstream.</p> <p>This test is only relevant for IRD with S/PDIF output.</p> <p><b>Equipment:</b></p> <div style="text-align: center;">  <pre> graph LR     A[MPEG-2 source] --&gt; B[MUX]     B --&gt; C[Exciter]     C --&gt; D[DVB receiver]     D --&gt; E[Monitor]     D --&gt; F[S/PDIF receiver]             </pre> </div> <p>A transport stream containing a service with AC-3 multichannel audio.</p> <p><b>Test procedure:</b></p> <ol style="list-style-type: none"> <li>1. Connect the IRD to a S/PDIF receiver e.g. Home Theater System with S/PDIF.</li> <li>2. Verify that service has a multichannel AC-3 audio available.</li> <li>3. In receiver menu, select stereo audio.</li> <li>4. Verify that AC-3 multichannel is decoded and downmixed to PCM stereo bitstream for S/PDIF output.</li> <li>5. Verify the audio output level can be adjusted.</li> <li>6. In receiver menu, select multichannel audio.</li> <li>7. Verify that AC-3 multichannel is passed-through as native bitstream for S/PDIF output.</li> </ol> <p><b>Expected result:</b></p> <p>IRD supports AC-3 audio decoding and downmixing to PCM stereo when stereo audio is selected.</p> <p>IRD supports AC-3 audio pass-through native bitstream when multichannel audio is</p>		



	selected.
<b>Test result(s)</b>	
<b>Conformity</b>	<input type="checkbox"/> OK Fault <input type="checkbox"/> Major <input type="checkbox"/> Minor, define fail reason in comments
<b>Comments</b>	If possible describe if fault can be fixed with software update: <input type="checkbox"/> YES <input type="checkbox"/> NO Describe more specific faults and/or other information
<b>Date</b>	<b>Sign</b>

<b>Test Case</b>	<b>Task 7:10 AC-3: Metadata</b>
<b>Section</b>	NorDig Unified 6.2.2.2
<b>Requirement</b>	The NorDig IRD supporting E-AC-3 and AC-3 shall support the use of a complete set of Dolby metadata [36] embedded in the audio stream when decoding AC-3 or E-AC-3 bitstreams, transcoding E-AC-3 bitstreams to AC-3, or creating a PCM stereo downmix from a decoded EAC-3 or AC-3 bitstream.
<b>IRD Profile(s)</b>	Basic, IRD, FE
<b>Test procedure</b>	TBD
<b>Test result(s)</b>	
<b>Conformity</b>	<input type="checkbox"/> OK Fault <input type="checkbox"/> Major <input type="checkbox"/> Minor, define fail reason in comments
<b>Comments</b>	If possible describe if fault can be fixed with software update: <input type="checkbox"/> YES <input type="checkbox"/> NO Describe more specific faults and/or other information
<b>Date</b>	<b>Sign</b>

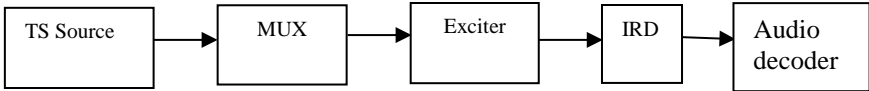
<b>Test Case</b>	<b>Task 7:11 E-AC-3: Requirements</b>
<b>Section</b>	NorDig Unified 6.2.2
<b>Requirement</b>	NorDig IRD supporting E-AC-3 and AC-3 shall <ul style="list-style-type: none"> <li>• decode AC-3 streams at all bit rates and sample rates listed in ETSI TS 102 366 [36] (not including Annex E).</li> <li>•(additionally) decode E-AC-3 streams with data rates from 32 kbps to 3 024 kbps and support all sample rates listed in TS 102 366 [36] Annex E.</li> <li>• be capable of transcoding E-AC-3 bitstreams to AC-3 bitstreams according to TS 102 366 [36]. Transcoding to AC-3 audio streams shall be at a fixed bit rate of 640 kbps.</li> </ul>
<b>IRD Profile(s)</b>	Basic, IRD, FE
<b>Test procedure</b>	<p><b>Purpose of test:</b> To verify that the IRD supports different E-AC-3 bit rates and sampling rates.</p> <p><b>Equipment:</b></p>  <pre> graph LR     TS[TS Source] --&gt; MUX[MUX]     MUX --&gt; Exciter[Exciter]     Exciter --&gt; IRD[IRD]     IRD --&gt; Decoder[Audio decoder]   </pre> <p>The TS shall contain services, which has</p> <ul style="list-style-type: none"> <li>• a E-AC-3 (mono, stereo) audio component with relevant signaling at bit rates and sampling rates:</li> </ul>

	<ul style="list-style-type: none"> <li>○ Sampling rates 32, 44,1 and 48 kHz</li> <li>● Bit rates 64, 192, 384 and 640 kbit/s a E-AC-3 (multichannel) audio component with relevant signaling at bit rates and sampling rates: <ul style="list-style-type: none"> <li>○ Sampling rates 32, 44,1 and 48 kHz</li> </ul> </li> </ul> <p>Bit rates 64, 192, 384 and 640 kbit/s</p> <p><b>Test procedure:</b></p> <ol style="list-style-type: none"> <li>1. Connect the IRD to an audio receiver, e.g. Home Theater System with HDMI.</li> <li>2. Verify that service has a multichannel E-AC-3 audio available.</li> <li>3. In receiver menu, select MPEGstereo audio.</li> <li>4. Verify that E-AC-3 multichannel is decoded and downmixed to PCM stereo bitstream for HDMI output and if supported for HDMI ARC.</li> <li>5. Verify the audio output level can be adjusted.</li> <li>6. In receiver menu, select multichannel audio.</li> <li>7. Verify that E-AC-3 multichannel is passed-through as native bitstream for HDMI output.</li>   <li>8. Verify that service has a stereo E-AC-3 audio available.</li> <li>9. In receiver menu, select MPEGstereo audio.</li> <li>10. Verify that E-AC-3 stereo is decoded and downmixed to PCM stereo bitstream for HDMI output and if supported for HDMI ARC.</li> <li>11. Verify the audio output level can be adjusted.</li> <li>12. In receiver menu, select multichannel audio.</li> <li>13. Verify that E-AC-3 stereo is passed-through as native bitstream for HDMI output.</li> </ol> <p><b>Expected result:</b></p> <p>IRD supports for E-AC-3 input audio signal and down-mix to stereo.</p>
--	-------------------------------------------------------------------------------------------------------------------------------------------------------------------------------------------------------------------------------------------------------------------------------------------------------------------------------------------------------------------------------------------------------------------------------------------------------------------------------------------------------------------------------------------------------------------------------------------------------------------------------------------------------------------------------------------------------------------------------------------------------------------------------------------------------------------------------------------------------------------------------------------------------------------------------------------------------------------------------------------------------------------------------------------------------------------------------------------------------------------------------------------------------------------------------------------------------------------------------------------------------------------------------------------------------------------------------------------------------------------------------------------------------------------------------------------------------------------------------------------------------------------------------------------------------------------------------------------------------------------------------------------------------

<b>Test result(s)</b>		Bit rate	Sampling rate	NOK or OK
	mono			
	stereo			
	Multichannel 5.1			
	Down-mix to stereo	N/A	N/A	

<b>Conformity</b>	<input type="checkbox"/> <b>OK Fault</b> <input type="checkbox"/> Major <input type="checkbox"/> Minor, define fail reason in comments
-------------------	----------------------------------------------------------------------------------------------------------------------------------------

<b>Comments</b>	If possible describe if fault can be fixed with software update: <input type="checkbox"/> <b>YES</b> <input type="checkbox"/> <b>NO</b> Describe more specific faults and/or other information
-----------------	---------------------------------------------------------------------------------------------------------------------------------------------------------------------------------------------------

<b>Date</b>	<b>Sign</b>
-------------	-------------

<b>Test Case</b>	<b>Task 7:12 E-AC-3: Analogue audio output</b>
<b>Section</b>	NorDig Unified 6.2.2
<b>Requirement</b>	The NorDig IRD with SCART and/or analogue outputs shall always have an audio signal present on the analogue outputs (SCART and stereo out, see section 8.5 and to built-in loudspeakers (see note 1)) if any of the supported formats is received.  If the NorDig IRD has analogue stereo output(s), it shall be capable of decoding and downmixing the supported audio formats for the analogue outputs.

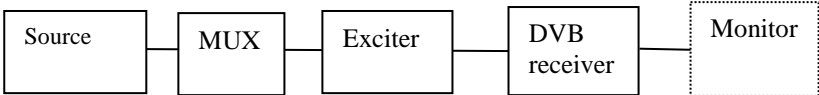
	NorDig IRD supporting E-AC-3 and AC-3 shall <ul style="list-style-type: none"> <li>(additionally) decode E-AC-3 streams with data rates from 32 kbps to 3 024 kbps and support all sample rates listed in TS 102 366 [36] Annex E.</li> </ul>
<b>IRD Profile(s)</b>	Basic, IRD, FE
<b>Test procedure</b>	<p><b>Purpose of test:</b> To verify that receiver decodes E-AC-3 bitstream and audio output level can be adjusted.</p> <p>This test is only mandatory for STB or IDTV with SCART or analogue audio output interface.</p> <p><b>Equipment:</b></p> <div style="text-align: center;">  <pre> graph LR     Source[Source] --- MUX[MUX]     MUX --- Exciter[Exciter]     Exciter --- DVB[DVB receiver]     DVB --- Monitor[Monitor] </pre> </div> <p>A transport stream containing a service with E-AC-3 multichannel audio.</p> <p><b>Test procedure:</b></p> <ol style="list-style-type: none"> <li>Verify that service has a multichannel E-AC-3 audio available.</li> <li>In receiver menu, select MPEG-1 Layer II audio, (Sometimes called PCM).</li> <li>Verify that E-AC-3 multichannel is downmixed to stereo at analog audio output.</li> <li>In receiver menu, select multichannel audio.</li> <li>Verify that E-AC-3 multichannel is downmixed to stereo at analog audio output.</li> </ol> <p><b>Expected result:</b></p> <p>IRD supports E-AC-3 audio decoding and audio is downmixed to stereo in analog audio output(s).</p> <p>The audio output level can be adjusted.</p>
<b>Test result(s)</b>	
<b>Conformity</b>	<input type="checkbox"/> OK Fault <input type="checkbox"/> Major <input type="checkbox"/> Minor, define fail reason in comments
<b>Comments</b>	If possible describe if fault can be fixed with software update: <input type="checkbox"/> YES <input type="checkbox"/> NO Describe more specific faults and/or other information
<b>Date</b>	<b>Sign</b>

<b>Test Case</b>	<b>Task 7:13 E-AC-3: HDMI output and HDMI ARC interface</b>
<b>Section</b>	NorDig Unified 6.2.2
<b>Requirement</b>	NorDig IRDs supporting E-AC-3 and AC-3 shall be capable of providing the following formats on the HDMI output connector connector from an E-AC-3 or AC-3 bitstream (see chapter 16 for factory default settings): <ul style="list-style-type: none"> <li>Pass-through of native bitstream (AC-3 and E-AC-3).</li> <li>E-AC-3 bitstream transcoded to AC-3 bitstream.</li> <li>Decoded and downmixed (if &gt; 2 channels) to PCM stereo bitstream</li> </ul>

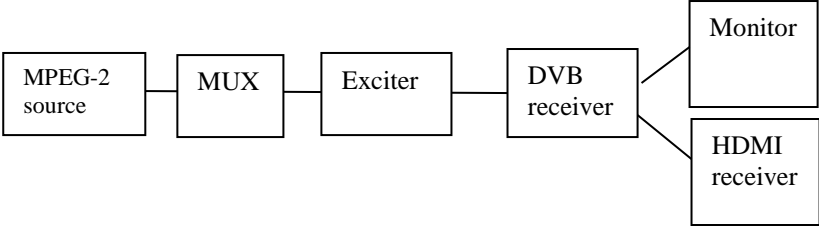
	<p>NorDig IRD supporting E-AC-3 and AC-3 shall</p> <ul style="list-style-type: none"> <li>• (additionally) decode E-AC-3 streams with data rates from 32 kbps to 3 024 kbps and support all sample rates listed in TS 102 366 [36] Annex E.</li> <li>• be capable of transcoding E-AC-3 bitstreams to AC-3 bitstreams according to TS 102 366 [36]. Transcoding to AC-3 audio streams shall be at a fixed bit rate of 640 kbps.</li> </ul>
<b>IRD Profile(s)</b>	Basic, IRD, FE
<b>Test procedure</b>	<p><b>Purpose of test:</b>          To verify that receiver decodes/transcodes and passes-through E-AC-3 bitstream.          To verify for the decoded E-AC-3 bitstream that the audio output level can be adjusted.</p> <p>This test is only relevant for IRD with HDMI output.</p> <p><b>Equipment:</b></p>  <pre>         graph LR             A[MPEG-2 source] --&gt; B[MUX]             B --&gt; C[Exciter]             C --&gt; D[DVB receiver]             D --&gt; E[Monitor]             D --&gt; F[HDMI receiver]         </pre> <p>A transport stream with E-AC-3 multichannel audio.</p> <p><b>Test procedure:</b></p> <ol style="list-style-type: none"> <li>1. Connect the IRD to an HDMI receiver e.g. Home Theater System with HDMI.</li> <li>2. Verify that service has a multichannel E-AC-3 audio available.</li> <li>3. In receiver menu, select stereo audio.</li> <li>4. Verify that E-AC-3 multichannel is decoded and downmixed to PCM stereo bitstream for HDMI output.</li> <li>5. Verify the audio output level can be adjusted.</li> <li>6. In receiver menu, select multichannel audio.</li> <li>7. Verify that E-AC-3 multichannel is passed-through as native bitstream* for HDMI output or transcoded to AC-3.</li> </ol> <p>* Receiving device supports E-AC-3 bitstream.</p> <p><b>Expected result:</b></p> <p>IRD supports E-AC-3 audio decoding and downmixing to PCM stereo when stereo audio is selected.</p> <p>IRD supports AC-3 audio pass-through native bitstream for HDMI output and/or HDMI ARC or transcode it to AC-3 if receiving device does not support E-AC-3 when multichannel audio is selected.</p>
<b>Test result(s)</b>	
<b>Conformity</b>	<input type="checkbox"/> OK Fault <input type="checkbox"/> Major <input type="checkbox"/> Minor, define fail reason in comments
<b>Comments</b>	If possible describe if fault can be fixed with software update: <input type="checkbox"/> YES <input type="checkbox"/> NO Describe more specific faults and/or other information
<b>Date</b>	<b>Sign</b>

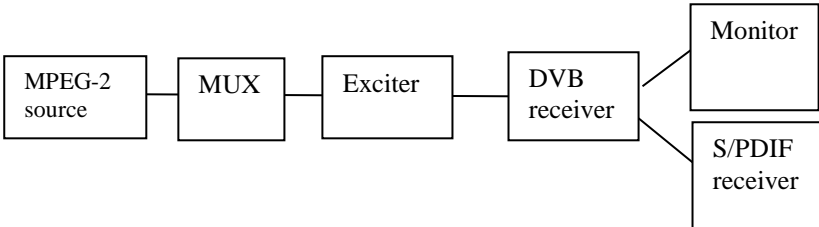
<b>Test Case</b>	<b>Task 7:14 E-AC-3: S/PDIF output interface</b>
<b>Section</b>	NorDig Unified 6.2.2
<b>Requirement</b>	<p>The NorDig IRD supporting E-AC-3 and AC-3 and including an S/PDIF output shall be capable of providing the following formats on the S/PDIF connector from an E-AC-3 or AC-3 bitstream:</p> <ul style="list-style-type: none"> <li>• E-AC-3 bitstream transcoded to AC-3 bitstream</li> <li>• Decoded and downmixed (if &gt; 2 channels) to PCM stereo bitstream</li> <li>• Pass-through of AC-3 bitstream</li> </ul> <p>NorDig IRD supporting E-AC-3 and AC-3 shall</p> <ul style="list-style-type: none"> <li>· (additionally) decode E-AC-3 streams with data rates from 32 kbps to 3 024 kbps and support all sample rates listed in TS 102 366 [36] Annex E.</li> <li>· be capable of transcoding E-AC-3 bitstreams to AC-3 bitstreams according to TS 102 366 [36]. Transcoding to AC-3 audio streams shall be at a fixed bit rate of 640 kbps.</li> </ul>
<b>IRD Profile(s)</b>	Basic, IRD, FE
<b>Test procedure</b>	<p><b>Purpose of test:</b> To verify that receiver decodes/transcodes E-AC-3 bitstream.</p> <p>This test is only relevant for IRD with S/PDIF output.</p> <p><b>Equipment:</b></p>  <pre> graph LR     A[MPEG-2 source] --&gt; B[MUX]     B --&gt; C[Exciter]     C --&gt; D[DVB receiver]     D --&gt; E[Monitor]     D --&gt; F[S/PDIF receiver]     </pre> <p>A transport stream with E-AC-3 multichannel audio.</p> <p><b>Test procedure:</b></p> <ol style="list-style-type: none"> <li>1. Connect the IRD to a S/PDIF receiver e.g. Home Theater System with S/PDIF.</li> <li>2. Verify that service has a multichannel E-AC-3 audio available.</li> <li>3. In receiver menu, select stereo audio.</li> <li>4. Verify that E-AC-3 multichannel is decoded and downmixed to PCM stereo bitstream for S/PDIF output.</li> <li>5. In receiver menu, select multichannel audio.</li> <li>6. Verify that E-AC-3 multichannel is passed-through as native bitstream for S/PDIF output.</li> </ol> <p><b>Expected result:</b></p> <p>IRD supports E-AC-3 audio decoding to PCM stereo bitstream when stereo audio is selected. IRD supports E-AC-3 transcode to AC-3 when multichannel audio is selected.</p>
<b>Test result(s)</b>	
<b>Conformity</b>	<input type="checkbox"/> OK Fault <input type="checkbox"/> Major <input type="checkbox"/> Minor, define fail reason in comments
<b>Comments</b>	If possible describe if fault can be fixed with software update: <input type="checkbox"/> YES <input type="checkbox"/> NO

	Describe more specific faults and/or other information
<i>Date</i>	<i>Sign</i>

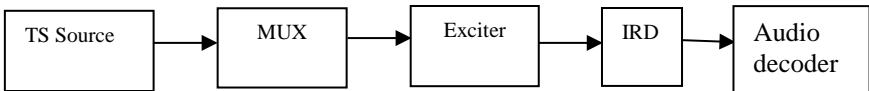
<i>Test Case</i>	<b>Task 7:15 E-AC-3: Metadata</b>
<i>Section</i>	NorDig Unified 6.2.2.2
<i>Requirement</i>	The NorDig IRD supporting E-AC-3 and AC-3 shall support the use of a complete set of Dolby metadata [36] embedded in the audio stream when decoding AC-3 or E-AC-3 bitstreams, transcoding E-AC-3 bitstreams to AC-3, or creating a PCM stereo downmix from a decoded EAC-3 or AC-3 bitstream.
<i>IRD Profile(s)</i>	Basic, IRD, FE
<i>Test procedure</i>	<p><b>Purpose of test:</b> To verify that the IRD supports Dolby metadata.</p> <p><b>Equipment:</b></p>  <pre> graph LR     TS[TS Source] --&gt; MUX[MUX]     MUX --&gt; Exciter[Exciter]     Exciter --&gt; IRD[IRD]     IRD --&gt; Decoder[Audio decoder]   </pre> <p>The TS shall contain a service E-AC-3, which has the following metadata included in audio component:</p> <ul style="list-style-type: none"> <li>• DolbyDynamicRange Control</li> <li>• Dolby Dialogue Normalization according to ISO/IEC 14496-3 : 2005 (Audio 3rd edition)</li> <li>• Down Mix parameters</li> </ul> <p><b>Test procedure:</b></p> <ol style="list-style-type: none"> <li>1. Setup the system</li> <li>2. Connect audio decoder to HDMI output.</li> <li>3. Verify that the IRD supports metadata correctly for decoding of the E-AC-3 stereo</li> <li>4. Verify that the IRD supports metadata correctly for transcoding E-AC-3 multichannel to AC-3.</li> <li>5. Verify that the IRD supports metadata correctly for creating PCM stereo downmix.</li> </ol> <p><b>Expected result:</b> IRD shall support E-AC-3 metadata according to requirement.</p>
<i>Test result(s)</i>	
<i>Conformity</i>	<input type="checkbox"/> OK Fault <input type="checkbox"/> Major <input type="checkbox"/> Minor, define fail reason in comments
<i>Comments</i>	If possible describe if fault can be fixed with software update: <input type="checkbox"/> YES <input type="checkbox"/> NO Describe more specific faults and/or other information

<i>Date</i>		<i>Sign</i>	
-------------	--	-------------	--

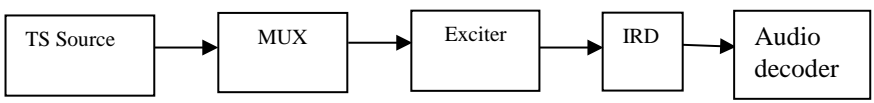
<i>Test Case</i>	<b>Task 7:16 HE AAC: Requirements</b>
<i>Section</i>	NorDig Unified 6.2.3
<i>Requirement</i>	<p>NorDig IRDs supporting HE-AAC (and thereby also AAC-LC) shall be capable of:</p> <ul style="list-style-type: none"> <li>• decoding HE-AAC Version 1 at Level 2 at sampling rates of 48 kHz according to ETSI TS 101 154 [29].</li> <li>• decoding, including downmixing HE-AAC Version 1 at Level 4 (multi-channel, up to 5.1) at sampling rates of 48 kHz according to ETSI TS 101 154 [29], Annex C (downmix).</li> <li>• transcoding HE-AAC Version 1 at Level 4 (multi-channel, up to 5.1) at sampling rates of 48 kHz according to TS 101 154 [29], Annex H to AC-3 or DTS.</li> </ul> <p>Nordig IRDs shall be able to skip bitstream elements that are not recognized, i.e. unknown Fill elements and Data Stream elements.</p> <p>If NorDig IRD is supporting HE-AAC audio stream transcoding to AC-3 audio stream, it shall be done according to TS 102 366 [36]. Transcoding to AC-3 multichannel audio streams shall be at a fixed bit rate of 640 kbps.</p> <p>If NorDig IRD is supporting HE-AAC audio stream transcoding to DTS audio stream, it shall be done according to TS 102 114 [33] at a fixed bit rate of 1,536 Mbps.</p>
<i>IRD Profile(s)</i>	Basic, IRD, FE
<i>Test procedure</i>	<p><b>Purpose of test:</b> To verify that the IRD supports HE AAC requirements.</p> <p><b>Equipment:</b></p>  <pre> graph LR     TS[TS Source] --&gt; MUX[MUX]     MUX --&gt; Exciter[Exciter]     Exciter --&gt; IRD[IRD]     IRD --&gt; Decoder[Audio decoder]   </pre> <p>The TS shall contain</p> <ul style="list-style-type: none"> <li>• a service with HE AAC Level 2 @48kHz (mono, stereo) audio component with relevant signaling.</li> <li>• a service with HE AAC Level 4 @ 48kHz (multichannel) audio component with relevant signaling.</li> </ul> <p><b>Test procedure:</b></p> <ol style="list-style-type: none"> <li>1. Connect the IRD to an audio receiver, e.g. Home Theater System with HDMI.</li> <li>2. Verify that service has a multichannel HE AAC audio available.</li> <li>3. In receiver menu, select MPEG stereo audio.</li> <li>4. Verify that HE AAC multichannel is decoded and downmixed to PCM stereo bitstream for HDMI output and if supported for HDMI ARC.</li> <li>5. Verify the audio output level can be adjusted.</li> <li>6. In receiver menu, select multichannel audio.</li> <li>7. Verify that HE AAC multichannel is transcoded to DTS or AC-3 bitstream for HDMI output.</li> <li>8. Verify that service has a stereo HE AAC audio available.</li> <li>9. In receiver menu, select MPEG stereo audio.</li> <li>10. Verify that HE AAC stereo is decoded and downmixed to PCM stereo</li> </ol>

	<p>bitstream for HDMI output and if supported for HDMI ARC.</p> <ol style="list-style-type: none"> <li>11. Verify the audio output level can be adjusted.</li> <li>12. In receiver menu, select multichannel audio.</li> <li>13. Verify that HE AAC stereo is transcoded to DTS or AC-3 bitstream for HDMI output.</li> </ol> <p><b>Expected result:</b></p> <p>IRD supports decoding of HE AAC Level 2 and 4 @ 48 kHz and transcoding of it to AC-3 or DTS and supports down-mixing.</p>												
<i>Test result(s)</i>	<table border="1"> <thead> <tr> <th>Feature</th> <th>NOK or OK</th> </tr> </thead> <tbody> <tr> <td>Decoding of HE AAC L2 @48kHz</td> <td></td> </tr> <tr> <td>Decoding of HE AAC L4 @48kHz</td> <td></td> </tr> <tr> <td>Transcoding of HE AAC L4 @48kHz to AC-3 at 640kbps</td> <td></td> </tr> <tr> <td>Transcoding of HE AAC L4 @48kHz to DTS 1.536Mbps</td> <td></td> </tr> <tr> <td>Down-mixing of HE AAC L4 @48kHz</td> <td></td> </tr> </tbody> </table>	Feature	NOK or OK	Decoding of HE AAC L2 @48kHz		Decoding of HE AAC L4 @48kHz		Transcoding of HE AAC L4 @48kHz to AC-3 at 640kbps		Transcoding of HE AAC L4 @48kHz to DTS 1.536Mbps		Down-mixing of HE AAC L4 @48kHz	
Feature	NOK or OK												
Decoding of HE AAC L2 @48kHz													
Decoding of HE AAC L4 @48kHz													
Transcoding of HE AAC L4 @48kHz to AC-3 at 640kbps													
Transcoding of HE AAC L4 @48kHz to DTS 1.536Mbps													
Down-mixing of HE AAC L4 @48kHz													
<i>Conformity</i>	<input type="checkbox"/> <b>OK</b> <input type="checkbox"/> <b>Fault</b> <input type="checkbox"/> Major <input type="checkbox"/> Minor, define fail reason in comments												
<i>Comments</i>	<p>If possible describe if fault can be fixed with software update: <input type="checkbox"/> <b>YES</b> <input type="checkbox"/> <b>NO</b></p> <p>Describe more specific faults and/or other information</p>												
<i>Date</i>	<table border="1"> <tr> <td style="width: 50%;"></td> <td style="width: 20%; text-align: center;"><i>Sign</i></td> <td style="width: 30%;"></td> </tr> </table>		<i>Sign</i>										
	<i>Sign</i>												

<i>Test Case</i>	<b>Task 7:17 HE AAC: Analogue audio output</b>
<i>Section</i>	NorDig Unified 6.2.3.1
<i>Requirement</i>	<p>The NorDig IRD with SCART and/or analogue outputs shall always have an audio signal present on the analogue outputs (SCART and stereo out, see section 8.5 and to built-in loudspeakers (see note 1)) if any of the supported formats is received.</p> <p>If the NorDig IRD has analogue stereo output(s), it shall be capable of decoding and downmixing the supported audio formats for the analogue outputs.</p> <p>NorDig IRDs supporting HE-AAC (and thereby also AAC-LC) shall be capable of:</p> <ul style="list-style-type: none"> <li>• decoding HE-AAC Version 1 at Level 2 at sampling rates of 48 kHz according to ETSI TS 101 154 [29].</li> <li>• decoding, including downmixing HE-AAC Version 1 at Level 4 (multi-channel, up to 5.1) at sampling rates of 48 kHz according to ETSI TS 101 154 [29], Annex C (downmix).</li> </ul>
<i>IRD Profile(s)</i>	Basic, IRD, FE
<i>Test procedure</i>	<p><b>Purpose of test:</b></p> <p>To verify that receiver decodes HE AAC bitstream and the audio output level can be adjusted.</p> <p>This test is only mandatory for STB or IDTV with SCART or analogue audio output interface.</p> <p><b>Equipment:</b></p>



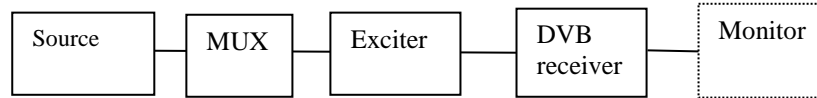

A transport stream shall contain:

- a service with HE AAC Level 2 @ 48kHz (stereo) audio component with relevant signaling.
- a service with HE AAC Level 4 @ 48kHz (multichannel) audio component with relevant signaling.

**Test procedure:**

1. Verify that services are available.
2. In receiver menu, select stereo audio.
3. Select service with HE AAC Level 2 @ 48kHz (stereo).
4. Verify that stereo audio is available at analog audio output.
5. Verify the audio output level can be adjusted.
6. Select service with HE AAC Level 4 @ 48kHz (multichannel)
7. Verify that HE AAC multichannel is downmixed to stereo at analog audio output and HE AAC stereo is available at analog audio output.
8. Verify the audio output level can be adjusted.
9. In receiver menu, select multichannel audio.
10. Verify that HE AAC multichannel is downmixed to stereo at analog audio output and HE AAC stereo is available at analog audio output.

**Expected result:**

IRD supports HE AAC stereo audio decoding to stereo audio and the audio output level can be adjusted.  
 IRD supports HE AAC multichannel audio downmixing to stereo in analog audio output(s) and the audio output level can be adjusted.

<b>Test result(s)</b>	
<b>Conformity</b>	<input type="checkbox"/> OK <input type="checkbox"/> Fault <input type="checkbox"/> Major <input type="checkbox"/> Minor, define fail reason in comments
<b>Comments</b>	If possible describe if fault can be fixed with software update: <input type="checkbox"/> YES <input type="checkbox"/> NO Describe more specific faults and/or other information
<b>Date</b>	<b>Sign</b>

<b>Test Case</b>	<b>Task 7:18 HE AAC: HDMI output and HDMI ARC interface</b>
<b>Section</b>	NorDig Unified 6.2.3.1
<b>Requirement</b>	NorDig IRDs supporting HE-AAC shall be capable of providing the following formats on the HDMI output connector from a HE-AAC bitstream (see chapter 16 for factory default settings): <ul style="list-style-type: none"> <li>• Transcoded to AC-3 or DTS bitstream.</li> <li>• Decoded and downmixed (if &gt; 2 channels) to PCM stereo bitstream</li> </ul>
<b>IRD Profile(s)</b>	Basic, IRD, FE
<b>Test procedure</b>	<b>Purpose of test:</b> To verify that receiver decodes/transcodes and passes-through HE AAC bitstream. When HE AAC bitstream is decoded and transcoded the audio output level can be adjusted.

This test is only relevant for IRD with HDMI output and HDMI ARC.

**Equipment:**

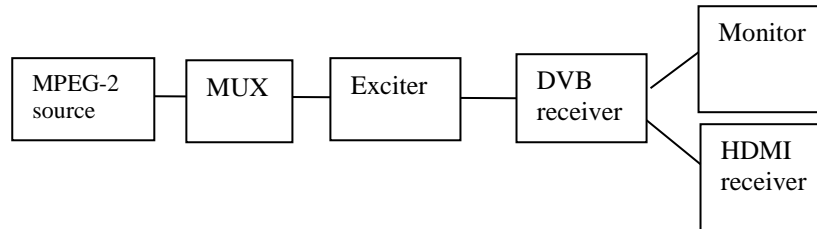

A transport stream contains:

- a service with HE AAC Level2 @48kHz (mono, stereo) audio component with relevant signaling.
- a service with HE AAC Level 4 @48kHz (multichannel) audio component with relevant signaling.

**Test procedure:**

1. Connect the IRD to HDMI receiver e.g. Home Theater System with HDMI.
2. Verify that services are available.
3. In receiver menu, select stereo audio.
4. Select service with HE AAC Level2@48kHz (stereo).
5. Verify that HE AAC stereo is transcoded to PCM stereo audio bitstream at HDMI output and HDMI ARC.
6. Verify the audio output level can be adjusted.
7. Select service with HE AAC Level4@48kHz (multichannel)
8. Verify that HE AAC multichannel is downmixed to PCM stereo at HDMI output and HDMI ARC.
9. Verify the audio output level can be adjusted.
10. In receiver menu, select multichannel audio.
11. Verify that HE AAC multichannel is transcoded to AC-3 or DTS multichannel at HDMI output and HDMI ARC

**Expected result:**

IRD supports HE AAC stereo audio decoding to PCM stereo bitstream at its HDMI output and HDMI ARC when stereo audio is selected. The audio output level can be adjusted.

IRD supports HE AAC multichannel audio transcoding to AC-3 and/or DTS at its HDMI output and HDMI ARC when multichannel is selected.

<b>Test result(s)</b>	
<b>Conformity</b>	<input type="checkbox"/> OK Fault <input type="checkbox"/> Major <input type="checkbox"/> Minor, define fail reason in comments
<b>Comments</b>	If possible describe if fault can be fixed with software update: <input type="checkbox"/> YES <input type="checkbox"/> NO Describe more specific faults and/or other information
<b>Date</b>	<b>Sign</b>
<b>Test Case</b>	<b>Task 7:19 HE AAC: S/PDIF output interface</b>

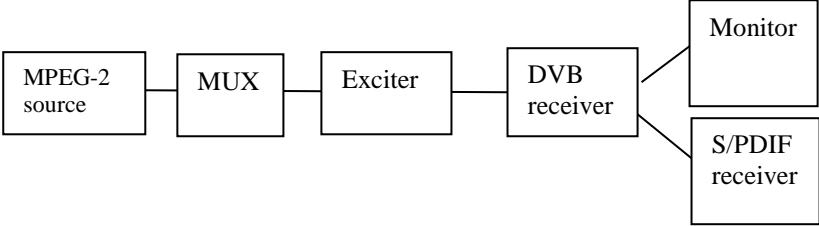
<b>Section</b>	NorDig Unified 6.2.3.1
<b>Requirement</b>	<p>The NorDig IRD supporting HE-AAC and including an S/PDIF output shall be capable of providing the following formats on the S/PDIF connector from a HE-AAC bitstream:</p> <ul style="list-style-type: none"> <li>• Decoded and downmixed (if &gt; 2 channels) to PCM stereo bitstream</li> <li>• Transcoded to AC-3 or DTS bitstream</li> </ul>
<b>IRD Profile(s)</b>	Basic, IRD, FE
<b>Test procedure</b>	<p><b>Purpose of test:</b> To verify that receiver decodes/transcodes and passes-through HE AAC bitstream.</p> <p>This test is only relevant for IRD with S/PDIF output.</p> <p><b>Equipment:</b></p>  <pre> graph LR     A[MPEG-2 source] --&gt; B[MUX]     B --&gt; C[Exciter]     C --&gt; D[DVB receiver]     D --&gt; E[Monitor]     D --&gt; F[S/PDIF receiver]   </pre> <p>A transport stream contains:</p> <ul style="list-style-type: none"> <li>• a service with HE AAC Level 2 @48kHz (mono, stereo) audio component with relevant signaling.</li> <li>• a service with HE AAC Level 4 @48kHz (multichannel) audio component with relevant signaling.</li> </ul> <p><b>Test procedure:</b></p> <ol style="list-style-type: none"> <li>1. Connect the IRD to S/PDIF receiver e.g. Home Theater System with S/PDIF.</li> <li>2. Verify that services are available.</li> <li>3. In receiver menu, select stereo audio.</li> <li>4. Verify that HE AAC multichannel is transcoded to PCM stereo at S/PDIF output and HE AAC stereo is transcoded to PCM stereo at S/PDIF output.</li> <li>5. In receiver menu, select multichannel audio.</li> <li>6. Verify that HE AAC multichannel is transcoded to AC-3 or DTS multichannel at S/PDIF output and HE-AAC stereo is transcoded to AC-3 2.0 or PCM stereo at S/PDIF output.</li> </ol> <p><b>Expected result:</b></p> <p>IRD supports HE AAC stereo audio decoding to PCM stereo when stereo is selected at its S/PDIF output.</p> <p>IRD supports HE AAC multichannel transcode to AC-3 and/or DTS at its S/PDIF output when multichannel is selected.</p>
<b>Test result(s)</b>	
<b>Conformity</b>	<input type="checkbox"/> OK <input type="checkbox"/> Fault <input type="checkbox"/> Major <input type="checkbox"/> Minor, define fail reason in comments
<b>Comments</b>	<p>If possible describe if fault can be fixed with software update: <input type="checkbox"/> YES <input type="checkbox"/> NO</p> <p>Describe more specific faults and/or other information</p>

<i>Date</i>	<i>Sign</i>
-------------	-------------

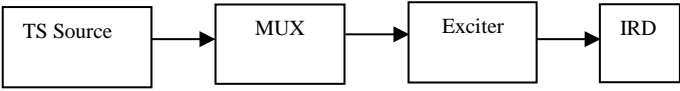
<i>Test Case</i>	<b>Task 7:20 HE AAC: Metadata</b>
<i>Section</i>	NorDig Unified 6.2.3.2
<i>Requirement</i>	<p>The NorDig IRD supporting HE-AAC shall support the use of the following MPEG-4 AAC metadata embedded in the audio stream when decoding HE-AAC and transcoding HE-AAC multi-channel to AC-3 or DTS:</p> <ul style="list-style-type: none"> <li>• Program Reference Level according to ISO/IEC 14496-3 [57] (prog_ref_level)</li> <li>• Downmix Parameters according to "Transmission of MPEG4 Ancillary Data" part of DVB specification ETSI TS 101 154 [29] (center_mix_level, surround_mix_level)</li> <li>• Dynamic Range Control (DRC) according to ISO/IEC 14496-3 [57] (dyn_rng_sgn, dyn_rng_ctl)</li> <li>• Heavy Compression according to ETSI TS 101 154 Annex C.5.2.5 (compression_on, compression_value)             <ul style="list-style-type: none"> <li>• compression_value)</li> </ul> </li> </ul>
<i>IRD Profile(s)</i>	Basic, IRD, FE
<i>Test procedure</i>	<p><b>Purpose of test:</b> To verify that the IRD supports HE AAC metadata.</p> <p><b>Equipment:</b></p>  <pre> graph LR     TS[TS Source] --&gt; MUX[MUX]     MUX --&gt; Exc[Exciter]     Exc --&gt; IRD[IRD]             </pre> <ul style="list-style-type: none"> <li>•</li> </ul> <p>The TS containing:</p> <ul style="list-style-type: none"> <li>• A service with program reference level (prog_ref_level)</li> <li>• A service with downmix parameters (center_mix_level, surround_mix_level)</li> <li>• A service with dynamic range control (dyn_rng_sgn, dyn_rng_ctl)</li> <li>• A service with heavy compression (compression_on, compression_value)</li> </ul> <p><b>Test procedure:</b></p> <ol style="list-style-type: none"> <li>1. Connect the IRD under the test to an amplifier that supports the metadata decoding</li> <li>2. Play the stream and tune the IRD to the service that contains the metadata</li> <li>3. Check that the IRD transforms the HE AAC metadata in the stream to the matching Dolby metadata. Note: A Dolby Reference decoder can be used to read the Dolby metadata values (if IRD transcodes to AC-3).</li> </ol> <p>NOTE: For IRD's that transcode to DTS, metadata might be more difficult to verify. DTS Reference decoder can be used</p> <p><b>Expected result:</b> IRD shall support HE AAC metadata according to requirement.</p>
<i>Test result(s)</i>	
<i>Conformity</i>	<input type="checkbox"/> <b>OK Fault</b> <input type="checkbox"/> Major <input type="checkbox"/> Minor, define fail reason in comments

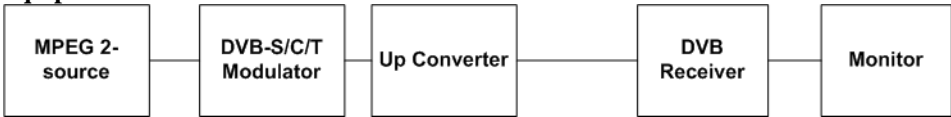

<b>Comments</b>	If possible describe if fault can be fixed with software update: <input type="checkbox"/> YES <input type="checkbox"/> NO Describe more specific faults and/or other information	
<b>Date</b>		<b>Sign</b>

<b>Test Case</b>	<b>Task 7:21 Audio prioritizing - Audio language support</b>	
<b>Section</b>	NorDig Unified 6.5, 6.5.1.1	
<b>Requirement</b>	<p>The user shall be able to select storable preferences for primary and secondary audio language. If an audio-stream according to the primary audio language preference is not associated with the chosen service the NorDig IRD shall automatically choose the audio stream according to the secondary audio language preference, if present. In addition the user shall be able to manually select between all audio-streams that are associated with the active service.</p> <p>For the selection of audio language (see Table 6.1 and Table 6.2), the NorDig IRD shall use the ISO 639 lanaguage code from the supplementary audio descriptor (1) and/or the ISO 639 language descriptor.</p>	
<b>IRD Profile(s)</b>	Basic, IRD, FE	
<b>Test procedure</b>	<p><b>Purpose of test:</b> To verify the support for primary and secondary audio language.</p> <p><b>Equipment:</b></p>  <pre> graph LR     A[MPEG 2-source] --- B[DVB-S/C/T Modulator]     B --- C[Up Converter]     C --- D[DVB Receiver]     D --- E[Monitor]     </pre> <p>Transport stream containing at least one service with two audio languages. Suitable languages are Swedish, Finnish, Norwegian, Danish, Icelandic, Sami, Irish/Gaelic and English.</p> <p><b>Test procedure:</b></p> <ol style="list-style-type: none"> <li>1. Verify a service with two different audio components is broadcasted dedicated for test of Nordic languages</li> <li>2. Verify the audio components are signaled correctly.</li> <li>3. Verify it is possible to select and setup primary and secondary audio language in the receiver setup.</li> <li>4. Verify the receiver selects the correct audio for primary language.</li> <li>5. Drop the audio component selected as primary audio language in receiver.</li> <li>6. Verify the receiver selects correct audio component, i.e. secondary audio language.</li> </ol> <p><b>Expected result:</b> It shall be possible to select primary and secondary language. If the selected primary language is not broadcasted, the selected secondary audio language shall be selected automatically.</p>	
<b>Test result(s)</b>		
<b>Conformity</b>	<input type="checkbox"/> OK Fault <input type="checkbox"/> Major <input type="checkbox"/> Minor, define fail reason in comments	
<b>Comments</b>	If possible describe if fault can be fixed with software update: <input type="checkbox"/> YES <input type="checkbox"/> NO Describe more specific faults and/or other information	

<i>Date</i>		<i>Sign</i>	

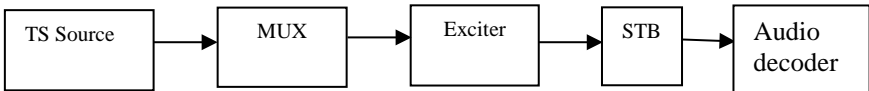
<i>Test Case</i>	<b>Task 7:22 Audio Prioritising – audio format and stream type</b>
<i>Section</i>	NorDig Unified 6.5
<i>Requirement</i>	<p>The NorDig IRD shall be able to select audio stream according to user selections, these settings should be stored in the IRD’s memory separately for each service. If manually selected audio is not able to be stored in the IRD’s memory per service, a global setting should be made possible to set manual prioritisation of stream type for all services. The priority for the selected audio source shall be based on the user selections and audio stream shall be selected according to the priority list in table table 6.1 below. If the user selections are not matching with the audio streams, the NorDig IRD shall always select one of the audio streams which closest suites with the user selections and will hereby provide audio to end-user.</p> <p>The user shall be able to select multi-channel audio for the digital outputs, when the outputs are equipped for multichannel audio.</p> <p>If multichannel mode is selected and if both multichannel and stereo streams are available for the selected language and audio type, the NorDig IRD shall use the multichannel audio stream to provide downmixed audio in analog audio output(s), if applicable, and suitable digital bitstream format in digital audio output(s) as e.g. in examples in Annex G (Example table when more than one audio codec is received).</p> <p>If stereo mode is selected and if both multichannel and stereo streams are available for the selected language and audio type, the NorDig IRD shall use the stereo audio source to provide audio in analog audio output(s), if applicable, and PCM stereo in digital audio output(s) as e.g. in examples in Annex G (Guidelines for NorDig IRD audio selection: “Example table when more than one audio stream is received”).</p>
<i>IRD Profile(s)</i>	Basic, IRD, FE
<i>Test procedure</i>	<p><b>Purpose of test:</b> To verify the audio priority selection and output audio format.</p> <p><b>Test Equipment:</b></p>  <pre> graph LR     TS[TS Source] --&gt; MUX[MUX]     MUX --&gt; Exciter[Exciter]     Exciter --&gt; STB[STB]     STB --&gt; Decoder[Audio decoder]   </pre> <p>Transport stream containing services with audio components (same language and audio type) listed in table below in test results.</p> <p>Suitable languages are Swedish, Finnish, Norwegian, Danish, Icelandic, Sami, Irish/Gaelic and English.</p> <p>Audio type is “normal”.</p> <p>Audio format and stream type shall be signaled in AAC_descriptor, AC-3_descriptor or E-AC-3_descriptor according to following:</p> <ol style="list-style-type: none"> <li>1) the AAC_type field in the AAC_descriptor for AAC audio,</li> <li>2) the number of channels flags in the AC-3 descriptor and Enhanced AC-</li> </ol>

3 descriptor for AC-3 and E-AC-3.  
 Correct signaling is broadcasted depending of the audio format and stream type in test results table. IRD is assumed to prioritise audio format and stream type according to list above.

**Test procedure:**

1. Setup the system
2. Verify that the audio selection is done correctly according the input formats in table below in test results
3. Repeat test with all input format in table below
4. Fill in test results

**Expected result:**

The IRD shall select the audio format and stream type correctly.

*Test result(s)*

Available inputs formats (same language and audio type)	Output on analog interface or integrated loudspeakers		OK/NOK
	When Stereo is selected (default)	When Multichannel is selected	
MPEG1 layer II & AC-3	Decoded from MPEG1 LII	Downmixed from AC-3	
MPEG1 layer II & E-AC-3	Decoded from MPEG1 LII	Downmixed from E-AC-3	
HE AAC stereo & HE AAC multichannel	Decoded from HE AAC stereo	Downmixed from HE AAC multichannel	
HE AAC stereo & AC-3 multichannel	Decoded from HE AAC stereo	Downmixed from AC-3 multichannel	

Available inputs formats (same language and audio type)	Output on S/PDIF		OK/NOK
	When Stereo is selected (default)	When Multichannel is selected	
MPEG1 layer II & AC-3	PCM (from MPEG1 LII)	AC-3	
MPEG1 layer II & E-AC-3	PCM (from MPEG1 LII)	Transcoded to AC-3 (from E-AC-3)	
HE AAC stereo & HE AAC multichannel	PCM (from HE AAC stereo)	Transcoded to AC-3, or DTS (from HE AAC multichannel)	
HE AAC stereo & AC-3 multichannel	PCM (from HE AAC stereo)	AC-3	

Available inputs formats (same language and audio type)	Output on HDMI		OK/NOK
	When Stereo is selected (default)	When Multichannel is selected	
MPEG1 layer II & AC-3 multichannel	PCM (from MPEG1 LII)	AC-3	

	MPEG1 layer II & E-AC-3 multichannel	PCM (from MPEG1 LII)	AC-3 <sup>1)</sup>	
	MPEG1 layer II & E-AC-3	PCM (from MPEG1 LII)	E-AC-3	
	HE AAC stereo & HE AAC multichannel	PCM (from HE AAC stereo)	HE AAC multichannel	
	HE AAC stereo & HE AAC multichannel	PCM (from HE AAC stereo)	Transcoded <sup>2)</sup> to AC-3, or DTS	
	HE AAC stereo & AC-3 multichannel	PCM (from HE AAC stereo)	AC-3	
<p>1) transcoded to AC-3 if E-AC-3 is not supported by receiving device                  2) transcoded to AC-3 or DTS if HE AAC not supported by receiving device</p> <p style="text-align: center;">1.</p>				
<b>Conformity</b>	<input type="checkbox"/> <b>OK</b> <input type="checkbox"/> <b>Fault</b> <input type="checkbox"/> Major <input type="checkbox"/> Minor, define fail reason in comments			
<b>Comments</b>	If possible describe if fault can be fixed with software update: <input type="checkbox"/> <b>YES</b> <input type="checkbox"/> <b>NO</b> describe more specific faults and/or other information			
<b>Date</b>		<b>Sign</b>		

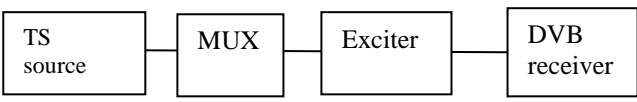
<b>Test Case</b>	<b>Task 7:23 Audio Prioritising – audio type</b>
<b>Section</b>	NorDig Unified 6.5
<b>Requirement</b>	The NorDig IRD shall be able to select audio stream according to user selections, these settings should be stored in the IRD’s memory separately for each service. If manually selected audio is not able to be stored in the IRD’s memory per service, a global setting should be made possible to set manual prioritisation of stream type for all services. The priority for the selected audio source shall be based on the user selections and audio stream shall be selected according to the priority list in table 6.1 below. If the user selections are not matching with the audio streams, the NorDig IRD shall always select one of the audio streams which closest suites with the user selections and will hereby provide audio to end-user.
<b>IRD Profile(s)</b>	Basic, IRD, FE
<b>Test procedure</b>	<p><b>Purpose of test:</b>                  Verify that IRD selects normal/undefined (0x00) audio component by default.</p> <p><b>Equipment:</b></p> <div style="text-align: center;">  <pre>                     graph LR                         TS[TS source] --- MUX[MUX]                         MUX --- Exciter[Exciter]                         Exciter --- DVB[DVB receiver]                     </pre> </div> <p>The TS must contain two services with several audio components for the same language,</p>



audio formats and stream type but different audio types.

Suitable languages are Swedish, Finnish, Norwegian, Danish, Icelandic, Sami, Irish/Gaelic and English.

Audio type is signaled in PMT in one or all of the following descriptors:

- 1) Supplementary\_audio\_descriptor for any stream type.
- 2) AAC\_descriptor for AAC audio.
- 3) AC-3 descriptor for AC-3 audio.
- 4) Enhanced AC-3 descriptor for E-AC-3 audio.
- 5) ISO639\_descriptor for any stream type.

IRD is assumed to prioritise the audio type signalization information in that order.

Audio format is stereo.

Stream type for all audio components is either MPEG-4 HE.AAC version 1 or E-AC-3 including metadata corresponding audio\_type.

	Service1	Service2	Frequency
MUX	SID 1100	SID 1200	Can be chosen depending of the distribution media
TS_id 1	S_name Test11	S_name Test12	
Network_id 1	PMT PID 1100	PMT PID 1200	
ON_id <sup>1)</sup>	V PID 1109	V PID 1209	
	A PID 1108	A PID 1208	
	ISO639_language_code <sup>2)</sup>	ISO639_language_code <sup>2)</sup>	
	Audio_type hearing impaired	Audio_type hearing impaired	
	A PID 1107	A PID 1207	
	ISO639_language_code <sup>2)</sup>	ISO639_language_code <sup>2)</sup>	
	Audio_type visual impaired commentary	Audio_type visual impaired commentary	
	A PID 1106	A PID 1206	
	ISO639_language_code <sup>2)</sup>	ISO639_language_code <sup>2)</sup>	
	Audio_type Normal/Undef	Audio_type Normal/Undef	
	LCD 1 visible	LCD 2 visible	

- 1) ON\_id (Original\_network\_id) can be chosen in range 0x0001-0xfe00 (operational network) and it shall be same for both muxes.
- 2) Language must be the same for all audio components and it can be one of the swe/fin/nor/ice/dan/smi/gle/iri/eng/und

**Test procedure:**

1. Verify the receiver selects audio component which has normal/undefined audio by default
2. Verify user is able to select different audio components.
3. Verify that the user is able to store selected audio component in the IRD's non-volatile memory, or can be set by changing the priority defined in list in table 6.1.
4. Put IRD into standby mode and unplug the power cord
5. Turn on the IRD
6. Zap to different service and verify that the IRD is selecting wanted audio.

**Expected result:**

IRD selects the audio component that is signalled as Normal/Undefined (0x00) by default when several audio components with the same language code, audio format and stream type but different audio type are available within one service.

The user shall also be able to select between the different audio components. The user should also be able to store the selected audio component priorisation to non-volatile memory.



<b>Test result(s)</b>	
<b>Conformity</b>	<input type="checkbox"/> OK Fault <input type="checkbox"/> Major <input type="checkbox"/> Minor, define fail reason in comments
<b>Comments</b>	If possible describe if fault can be fixed with software update: <input type="checkbox"/> YES <input type="checkbox"/> NO Describe more specific faults and/or other information
<b>Date</b>	<b>Sign</b>

<b>Test Case</b>	<b>Task 7:24 Audio Prioritising – audio format signaling missing</b>																											
<b>Section</b>	NorDig Unified 6.5.1.3																											
<b>Requirement</b>	<p>For the selection of audio format (mono, stereo or multichannel, see Table 6.1 [1] and Table 6.2 [1]), the NorDig IRD shall use:</p> <ul style="list-style-type: none"> <li>- the AAC_type field in the AAC_descriptor for AAC audio,</li> <li>- the number of channels flags in the AC-3 descriptor and Enhanced AC-3 descriptor for AC-3 and E-AC-3.</li> </ul> <p>In any case where, for some reason, this information is not carried in the PMT for a particular audio stream, then the IRD shall prioritise based on the assumption that audio stream contains “normal” stereo content.</p>																											
<b>IRD Profile(s)</b>	Basic, IRD, FE																											
<b>Test procedure</b>	<p><b>Purpose of test:</b> Verify which audio component the IRD selects when no additional audio format signalization is added to audio component.</p> <p><b>Equipment:</b></p> <div style="text-align: center;"> <pre> graph LR     TS[TS source] --- MUX[MUX]     MUX --- Exciter[Exciter]     Exciter --- DVB[DVB receiver]             </pre> </div> <p>The TS shall contain two services with two audio components. The PMTs shall contain the elementary streams with appropriate stream_types. All audio tracks shall be signaled with a same language and audio_type (0x0) in ISO_639_language_descriptor. No other descriptors shall be signaled for the audio streams.</p> <table border="0" style="width: 100%;"> <thead> <tr> <th></th> <th><b>Service1</b></th> <th><b>Service2</b></th> <th><b>Frequency</b></th> </tr> </thead> <tbody> <tr> <td>MUX</td> <td>SID 1100</td> <td>SID 1200</td> <td rowspan="6">Can be chosen depending of the distribution media</td> </tr> <tr> <td>TS_id 1</td> <td>S_name Test11</td> <td>S_name Test12</td> </tr> <tr> <td>Network_id 1</td> <td>PMT PID 1100</td> <td>PMT PID 1200</td> </tr> <tr> <td>ON_id <sup>1)</sup></td> <td>V PID 1109</td> <td>V PID 1209</td> </tr> <tr> <td></td> <td>A PID 1108 (HE AAC L4)</td> <td>A PID 1208 (AC-3 multichannel)</td> </tr> <tr> <td></td> <td>A PID 1107 (MPEG1 LII stereo)</td> <td>A PID 1207 (MPEG1 LII stereo)</td> </tr> <tr> <td></td> <td>LCD 1 visible</td> <td>LCD 2 visible</td> <td></td> </tr> </tbody> </table> <p>1) ON_id (Original_network_id) can be chosen in range 0x0001-0xfe00 (operational network) and it shall be same for both muxes.</p> <p><b>Test procedure:</b> 1. Configure the IRD to select ‘normal’ stereo audio.</p>		<b>Service1</b>	<b>Service2</b>	<b>Frequency</b>	MUX	SID 1100	SID 1200	Can be chosen depending of the distribution media	TS_id 1	S_name Test11	S_name Test12	Network_id 1	PMT PID 1100	PMT PID 1200	ON_id <sup>1)</sup>	V PID 1109	V PID 1209		A PID 1108 (HE AAC L4)	A PID 1208 (AC-3 multichannel)		A PID 1107 (MPEG1 LII stereo)	A PID 1207 (MPEG1 LII stereo)		LCD 1 visible	LCD 2 visible	
	<b>Service1</b>	<b>Service2</b>	<b>Frequency</b>																									
MUX	SID 1100	SID 1200	Can be chosen depending of the distribution media																									
TS_id 1	S_name Test11	S_name Test12																										
Network_id 1	PMT PID 1100	PMT PID 1200																										
ON_id <sup>1)</sup>	V PID 1109	V PID 1209																										
	A PID 1108 (HE AAC L4)	A PID 1208 (AC-3 multichannel)																										
	A PID 1107 (MPEG1 LII stereo)	A PID 1207 (MPEG1 LII stereo)																										
	LCD 1 visible	LCD 2 visible																										

	<ol style="list-style-type: none"> <li>2. Zap through the services in the stream.</li> <li>3. Verify that the IRD selects the MPEG1-LII audio component and audio is played out correctly.</li> <li>4. Configure the IRD to select 'normal' multichannel audio.</li> <li>5. Zap through the services in the stream.</li> <li>6. Verify that the IRD selects the advanced audio component and audio is played out correctly.</li> </ol> <p><b>Expected result:</b></p> <p>IRD selects the audio component that is signalled as Normal/Undefined (0x00) by default when several audio components without signaling is available within one service.</p>
<i>Test result(s)</i>	
<i>Conformity</i>	<input type="checkbox"/> OK Fault <input type="checkbox"/> Major <input type="checkbox"/> Minor, define fail reason in comments
<i>Comments</i>	If possible describe if fault can be fixed with software update: <input type="checkbox"/> YES <input type="checkbox"/> NO Describe more specific faults and/or other information
<i>Date</i>	<i>Sign</i>

<i>Test Case</i>	<b>Task 7:25 Audio video synchronization</b>
<i>Section</i>	NorDig Unified 6.7.1
<i>Requirement</i>	<p>The NorDig IRDs shall not introduce more than <math>\pm 5</math> ms of relative delay between the audio and video components on the primary output (1) and not more than <math>\pm 25</math> ms between the primary video output and a secondary audio output. (2)</p> <p>The relative delay between the audio and video components shall be continuously synchronized.</p> <p>If the NorDig IRD, as a part of an integrated digital TV set (IDTV) has an audio output, the audio shall be in sync with the video display.</p> <p>Where audio leaves the IRD in an encoded form (such as in IEC61937 [45] outputs and/or HDMI outputs and/or HDMI Audio Return Channel (ARC)), the IRD shall compensate for the decoding latency of the selected audio format, as specified for the relevant reference decoder for the selected format (e.g AC-3), such that the output of the reference decoder would be <math>\pm 5</math> ms with respect to the decoded video. This applies for all audio systems that the IRD supports.</p>
<i>IRD Profile(s)</i>	Basic, IRD, FE
<i>Test procedure</i>	<p><b>Purpose of test:</b></p> <p>To verify that the relative time delay difference between video and audio on primary output satisfies the specification.</p> <p>Mandatory for IDTVs with integrated loudspeakers.</p> <p>Relevant for STB and IDTVs with audio output interfaces for analog audio,HDMI output and HDMI ARC.</p> <p><b>Equipment:</b></p>

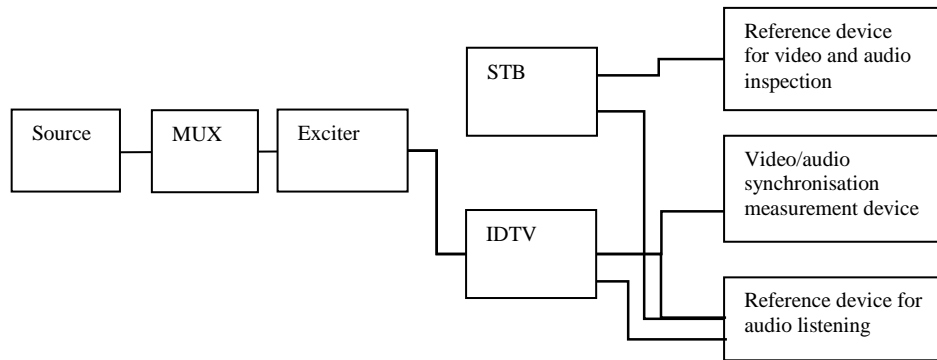

Transport stream containing:

- a 'Bounce' video signal (fully black and white pictures).
- The audio (sound bursts) is synchronized with the video.

**Test procedure:**

If the IRD is iDTV:

1. Subjectively verify the video content in the integrated display is in synchronization with the audio content on the integrated loudspeakers.
2. If any doubt is arisen for the synchronisation accuracy, measure the synchronization with the dedicated measurement equipment.
3. If the iDTV supports analog audio output or digital audio output on HDMI output, HDMI ARC or S/PDIF, connect a receiving reference device to such an output interface.
4. Verify subjectively if the audio on the reference device is in synchronization with the video displayed on the iDTV.
5. If any doubt is arisen for the synchronisation accuracy, measure the synchronization with the dedicated measurement equipment.

If the IRD is STB:

1. Connect a receiving reference device to primary HDMI output interface.
2. Verify subjectively if the audio on the reference device is in synchronization with the video displayed on the reference device.
3. If any doubt is arisen for the synchronisation accuracy, measure the synchronization with the dedicated measurement equipment.
4. If the STB supports analog audio output or digital audio output on S/PDIF, connect a receiving reference device to such an output interface.
5. Verify subjectively if the audio on the reference device is in synchronization with the video displayed on the reference device.

**Expected result:**

If the IRD is an iDTV

- the relative delay between video on integrated display and audio on integrated loudspeakers is less than  $\pm 5$  ms.
- the relative delay between video on integrated display and audio on the analog audio output or digital audio outputs HDMI output, HDMI ARC and S/PDIF is less than  $\pm 5$  ms.

If the IRD is an STB,

	<ul style="list-style-type: none"> <li>the relative delay between video and audio on HDMI output is less than <math>\pm 5</math> ms.</li> <li>the relative delay between video on reference display and audio on analog audio output or digital audio output S/PDIF is less than <math>\pm 5</math> ms.</li> </ul> <p>The secondary display output is not measured.</p>
<b>Test result(s)</b>	
<b>Conformity</b>	<input type="checkbox"/> OK Fault <input type="checkbox"/> Major <input type="checkbox"/> Minor, define fail reason in comments
<b>Comments</b>	If possible describe if fault can be fixed with software update: <input type="checkbox"/> YES <input type="checkbox"/> NO Describe more specific faults and/or other information
<b>Date</b>	<b>Sign</b>

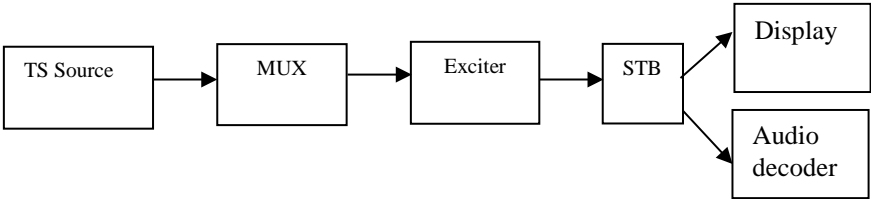
<b>Test Case</b>	<b>Task 7:26 Adjustment of Video/audio-delay</b>
<b>Section</b>	NorDig Unified 6.7.1
<b>Requirement</b>	The NorDig IRD shall support the possibility to adjust the audio-delay on the HDMI and S/PDIF output (if available) up to 250 ms and it should be adjustable in 5 ms steps, as the IRD may have several different user set-ups, resulting in different a/v delays; e.g. the IRD may be connected to several types of external audio-amplifiers and the IRD may be connected to several types of external screens.
<b>IRD Profile(s)</b>	Basic, IRD, FE
<b>Test procedure</b>	<p><b>Purpose of test:</b> To verify that the IRD has settings for video/audio delay. This requirement is only applicable to IRDs that are not part of an IDTV.</p> <p><b>Equipment:</b></p>  <pre> graph LR     TS[TS Source] --&gt; MUX[MUX]     MUX --&gt; Exciter[Exciter]     Exciter --&gt; STB[STB]     STB --&gt; Display[Display]     STB --&gt; Audio[Audio decoder]   </pre> <p><b>Test procedure:</b></p> <ol style="list-style-type: none"> <li>Verify the IRD has a setting to setup video/audio delay up to 250ms.</li> <li>Verify the setting has effect in delay between video and audio.</li> </ol> <p><b>Expected result:</b> It is possible to change static delay between video and audio decoding and it has effect.</p>
<b>Test result(s)</b>	
<b>Conformity</b>	<input type="checkbox"/> OK Fault <input type="checkbox"/> Major <input type="checkbox"/> Minor, define fail reason in comments
<b>Comments</b>	If possible describe if fault can be fixed with software update: <input type="checkbox"/> YES <input type="checkbox"/> NO Describe more specific faults and/or other information
<b>Date</b>	<b>Sign</b>

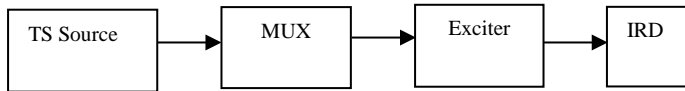
<b>Test Case</b>	<b>Task 7:27 Audio handling when changing service or audio format</b>	
<b>Section</b>	NorDig Unified 6.9	
<b>Requirement</b>	The NorDig IRD should gracefully handle change of service or audio format at the audio outputs without significant disturbances to the end user.	
<b>IRD Profile(s)</b>	Basic, IRD, FE	
<b>Test procedure</b>	<p><b>Purpose of test:</b> To verify that the IRD handles audio format changes in zapping and audio format change.</p> <p><b>Equipment:</b></p>  <pre> graph LR     TS[TS Source] --&gt; MUX[MUX]     MUX --&gt; Exciter[Exciter]     Exciter --&gt; IRD[IRD]   </pre> <p>The TS shall contain several services, but at least following services with following components</p> <ul style="list-style-type: none"> <li>• a HE AAC Level2 @48kHz and/or E-AC-3 (stereo)audio component with relevant signaling.</li> <li>• a HE AAC Level 4 @48kHz and/or E-AC-3 (multichannel)audio component with relevant signaling.</li> <li>• a MPEG-1 Layer II (stereo) with relevant signaling.</li> </ul> <p><b>Test procedure:</b></p> <ol style="list-style-type: none"> <li>1. Zap to different services</li> <li>2. Verify the IRD is able to settle to different audio formats</li> <li>3. Decide if the format settling could disturb end-user.</li> </ol> <p><b>Expected result:</b></p> <p>Audio format change is handled gracefully.</p> <p>Audio handling does not disturb the end-user.</p>	
<b>Test result(s)</b>		
<b>Conformity</b>	<input type="checkbox"/> <b>OK</b> <input type="checkbox"/> <b>Fault</b> <input type="checkbox"/> Major <input type="checkbox"/> Minor, define fail reason in comments	
<b>Comments</b>	If possible describe if fault can be fixed with software update: <input type="checkbox"/> <b>YES</b> <input type="checkbox"/> <b>NO</b> Describe more specific faults and/or other information	
<b>Date</b>		<b>Sign</b>

<b>Test Case</b>	<b>Task 7:28 Dynamic changes in audio components</b>
<b>Section</b>	NorDig Unified 6.9

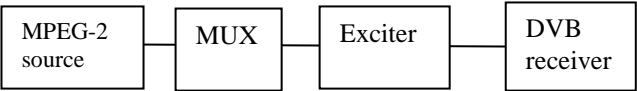
<p><b>Requirement</b></p>	<p>The NorDig IRD shall be able to handle dynamic changes of audio component(s) (PID/PIDs) in a service. The IRD shall automatically identify if an audio component is added or removed between two programme events in the same service). The NorDig IRD should gracefully handle change of service or audio format at the audio outputs without significant disturbances to the end user.</p> <p>The NorDig IRD shall handle the dynamic changes after change of selected service ("zapping") or dynamic PMT update (i.e. shall not require to re-install services) and shall be able to handle the following dynamic changes without user interaction and start decoding within one second after reception of change;</p> <ul style="list-style-type: none"> <li>• change of the audio codec, (for example change from MPEG-1 Layer II into AC-3)</li> <li>• change of ISO 639-2 [72] language for an audio component.</li> </ul>
<p><b>IRD Profile(s)</b></p>	<p>Basic, IRD, FE</p>
<p><b>Test procedure</b></p>	<p><b>Purpose of test:</b> To verify the IRD is able to handle dynamic changes of audio components in transmission.</p> <ul style="list-style-type: none"> <li>- change of number of audio channels within same audio codec (eg. AC-3 2.0 to AC-3 5.1 and vice versa.</li> <li>- change of bitrate for an audio component (eg. MPEG1-L2 bitrate from 192 kbps to 160 kbps)</li> <li>- change of audio PID value (any codec)</li> <li>- change from dual-channel audio into stereo audio and vice versa</li> <li>- removal of selected audio component and using the next preferred one</li> <li>- addition of one audio component with higher preferred user setting</li> <li>- change of the audio codec (eg. from MPEG1-L2 to AC-3</li> <li>- change of ISO 639-2 language for an audio component</li> </ul> <p><b>Equipment:</b></p> <div style="text-align: center;">  <pre> graph LR     A[MPEG-2 source] --- B[MUX]     B --- C[Exciter]     C --- D[DVB receiver]             </pre> </div> <p>MPEG-2 source must have capability to support dynamic changes in audio components within service(s). In case of dual-channel audio the first language_descriptor definition corresponds physical left channel and second language_descriptor definition corresponds physical right channel.</p> <p><b>Test procedure:</b></p> <ol style="list-style-type: none"> <li>1. Use MPEG-2 source to generate dynamic changes in audio components as listed in test results</li> <li>2. Fill in the test results.</li> </ol> <p><b>Expected result:</b></p> <p>IRD is able to handle dynamic changes in audio components.</p>
<p><b>Test result(s)</b></p>	

		<b>NOK or OK</b>
	Change of number of audio channels within same audio codec (eg. AC-3 2.0 to AC-3 5.1 and vice versa.	
	Change of bitrate for an audio component (eg. MPEG1-L2 bitrate from 192 kbps to 160 kbps)	
	Change of audio PID value (any codec)	
	Change from dual-channel audio into stereo audio and vice versa	
	Removal of selected audio component and using the next preferred one	
	Addition of one audio component with higher preferred user setting	
	Change of the audio codec (eg. from MPEG1-L2 to AC-3	
	Change of ISO 639-2 language for an audio component	
<b>Conformity</b>	<input type="checkbox"/> OK Fault <input type="checkbox"/> Major <input type="checkbox"/> Minor, define fail reason in comments	
<b>Comments</b>	If possible describe if fault can be fixed with software update: <input type="checkbox"/> YES <input type="checkbox"/> NO Describe more specific faults and/or other information	
<b>Date</b>		<b>Sign</b>

<b>Test Case</b>	<b>Task 7:29 Audio descriptors</b>	
<b>Section</b>	NorDig Unified 6.9	
<b>Requirement</b>	The NorDig IRD shall be able to read the audio information contained in the DVB_SI stream_content and component_type of the component descriptor as defined in EN 300 468 [16], see also chapter 12 and section 13.3.2. The NorDig IRD should be able to present the audio information, including the descriptors for audio description for the visually impaired and audio for the hard of hearing, contained in the component descriptor to the user for information and selection purposes.	
<b>IRD Profile(s)</b>	Basic, IRD, FE	
<b>Test procedure</b>	The IRD manufacturer shall describe the used test procedure and the used test setup.	
<b>Test result(s)</b>	The IRD manufacturer shall describe the used test procedure and the used test setup.	
<b>Conformity</b>	<input type="checkbox"/> OK Fault <input type="checkbox"/> Major <input type="checkbox"/> Minor, define fail reason in comments	
<b>Comments</b>	If possible describe if fault can be fixed with software update: <input type="checkbox"/> YES <input type="checkbox"/> NO Describe more specific faults and/or other information	
<b>Date</b>		<b>Sign</b>

<b>Test Case</b>	<b>Task 7:30 Clean audio</b>	
<b>Section</b>	NorDig Unified 6.10	
<b>Requirement</b>	The NorDig IRD should support the “Clean Audio” concept by implementing an easy way to adjust the balance between the centre channel and other channels in the audio stream before making a stereo down-mix. If implemented, clean audio shall be compliant to ETSI TS 101 154 [29].	
<b>IRD Profile(s)</b>	Basic, IRD, FE	
<b>Test procedure</b>		

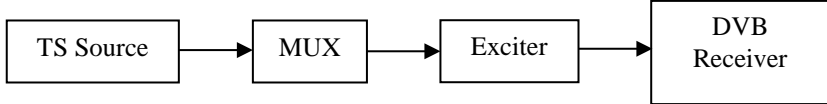

	TBD
<i>Test result(s)</i>	
<i>Conformity</i>	<input type="checkbox"/> OK Fault <input type="checkbox"/> Major <input type="checkbox"/> Minor, define fail reason in comments
<i>Comments</i>	If possible describe if fault can be fixed with software update: <input type="checkbox"/> YES <input type="checkbox"/> NO Describe more specific faults and/or other information
<i>Date</i>	<i>Sign</i>

<i>Test Case</i>	<b>Task 7:31 Supplementary audio</b>										
<i>Section</i>	NorDig Unified 6.11										
<i>Requirement</i>	<p>The Nordig IRD audio decoder shall (1) be capable of supporting ‘visual impaired’ Supplementary audio (SA) services, as defined in ETS TS 101 154 [29] (however, control of pan and fade is optional).</p> <p>The NorDig IRD shall (1) support both Broadcast mixed and Receiver mixed Supplementary Audio.</p> <p>The NorDig IRD shall (1) have user selection of audio preferences for ‘normal’ and ‘Supplementary’ audio and which is a fixed setting (i.e. remain when changing service and when re-starting the IRD).</p> <p>The user preference settings for enabled/disable default Supplementary audio shall (1) be common for Broadcast mixed (2) and Receiver mixed alternatives.</p>										
<i>IRD Profile(s)</i>	Basic, IRD, FE										
<i>Test procedure</i>	<p><b>Purpose of test:</b> To verify the IRD handles supplementary audio for narrator and spoken subtitling like of audio streams.</p> <p><b>Equipment:</b></p> <div style="text-align: center;">  <pre> graph LR     TS[TS Source] --&gt; MUX[MUX]     MUX --&gt; Exc[Exciter]     Exc --&gt; DVB[DVB Receiver]             </pre> </div> <p>A TS containing several services with several audio components for broadcast and receiver mixing.</p> <p>Supplementary_audio_descriptor is signalled for all audio components according to content definition below.</p> <p>The normal and supplementary audio for receiving mixing within a service are encoded as MPEG-1 Layer II, HE-AAC and E-AC-3 depending of which audio codecs are supported by the IRD. The audio streams sampling rate must be the same and the audio streams are separated to two different PIDs.</p> <table border="1" style="width: 100%; border-collapse: collapse;"> <thead> <tr> <th style="background-color: #d9e1f2;">Transmitter</th> <th style="background-color: #d9e1f2;">Service 1</th> <th style="background-color: #d9e1f2;">Service 2</th> <th style="background-color: #d9e1f2;">Frequency</th> </tr> </thead> <tbody> <tr> <td style="background-color: #d9e1f2;"> <b>MUX 1</b>                      TS_ID 1                      Network_ID 1                      ON_ID <sup>1)</sup> </td> <td style="background-color: #d9e1f2;">                     SID 1100                      S_Name Test11                      PMT PID 1100                      V PID 1109                      A PID                      1108ISO639_language_code <sup>2)</sup>                      Audio_type 0x00                      A PID 1107                      ISO639_descriptor:                      language_code <sup>2)</sup>                      audio_type 0x00                 </td> <td style="background-color: #d9e1f2;">                     SID 1200                      S_Name Test12                      PMT PID 1200                      V PID 1209                      A PID 1208                      ISO639_language_code <sup>2)</sup>                      Audio_type 0x00                      A PID 1207                      ISO639_descriptor:                      language_code <sup>2)</sup>                      Audio_type 0x03                      supplementary audio desc                 </td> <td style="background-color: #d9e1f2;">                     Can be chosen depending of the distribution media.                 </td> </tr> </tbody> </table>			Transmitter	Service 1	Service 2	Frequency	<b>MUX 1</b> TS_ID 1 Network_ID 1 ON_ID <sup>1)</sup>	SID 1100 S_Name Test11 PMT PID 1100 V PID 1109 A PID 1108ISO639_language_code <sup>2)</sup> Audio_type 0x00 A PID 1107 ISO639_descriptor: language_code <sup>2)</sup> audio_type 0x00	SID 1200 S_Name Test12 PMT PID 1200 V PID 1209 A PID 1208 ISO639_language_code <sup>2)</sup> Audio_type 0x00 A PID 1207 ISO639_descriptor: language_code <sup>2)</sup> Audio_type 0x03 supplementary audio desc	Can be chosen depending of the distribution media.
Transmitter	Service 1	Service 2	Frequency								
<b>MUX 1</b> TS_ID 1 Network_ID 1 ON_ID <sup>1)</sup>	SID 1100 S_Name Test11 PMT PID 1100 V PID 1109 A PID 1108ISO639_language_code <sup>2)</sup> Audio_type 0x00 A PID 1107 ISO639_descriptor: language_code <sup>2)</sup> audio_type 0x00	SID 1200 S_Name Test12 PMT PID 1200 V PID 1209 A PID 1208 ISO639_language_code <sup>2)</sup> Audio_type 0x00 A PID 1207 ISO639_descriptor: language_code <sup>2)</sup> Audio_type 0x03 supplementary audio desc	Can be chosen depending of the distribution media.								

	supplementary audio desc: "broadcast mixed" LCD 1 visible	"receiver mixed) LCD 2 visible	
<sup>1)</sup> ON_id (Original_network_id) can be chosen in range 0x0001-0xfe00 (operational network) <sup>2)</sup> Language must be the same for all audio components and it can be one of the swe/fin/nor/ice/dan/smi/gle/iri/eng/und			
<p><b>Test procedure:</b></p> <p>The selected language for primary language code is referred as Lang1 below.  The selected language for secondary language code is referred as Lang2 below.</p> <ol style="list-style-type: none"> <li>1. Set the primary audio selection to Lang1 and secondary to Lang2.</li> <li>2. Set audio type preference to "normal" audio.</li> <li>3. Tune to Service 1 and verify that audio PID 1108, Lang1 0x00 audio type is selected.</li> <li>4. Tune to Service 2 and verify that audio PID 1208, Lang1 0x00 audio type is selected.</li> <li>5. Set audio type preference to "supplementary audio".</li> <li>6. Tune to Service 1 and verify that audio PID 1107, Lang2 0x00 audio type is selected.</li> <li>7. Tune to Service 2 and verify that audio PID 1207, nar 0x03 audio type is mixed with audio PID 1208 audio and is audible.</li> </ol> <p><b>Expected result:</b></p> <p>Supplementary audio can be enabled and disabled from the menu.  IRD supports both broadcast mixed and receiver mixed supplementary audio.  IRD is able to select a correct audio track according to user preference setting.</p>			
<b>Test result(s)</b>			
<b>Conformity</b> <input type="checkbox"/> OK Fault <input type="checkbox"/> Major <input type="checkbox"/> Minor, define fail reason in comments			
<b>Comments</b> If possible describe if fault can be fixed with software update: <input type="checkbox"/> YES <input type="checkbox"/> NO Describe more specific faults and/or other information			
<b>Date</b>		<b>Sign</b>	

<b>Test Case</b>	<b>Task 7:32 IRD Internal Reference Level</b>
<b>Section</b>	NorDig Unified 6.12
<b>Requirement</b>	The level for reference tones for transmission will be 18 dB below clipping level, in accordance with EBU Recommendation R.68 "Alignment level in digital audio production equipment and in digital recorders" as recommended by ETSI TS 101 154.
<b>IRD Profile(s)</b>	Basic, IRD, FE
<b>Test procedure</b>	The IRD manufacturer shall describe the used test procedure and the used test setup.
<b>Test result(s)</b>	The IRD manufacturer shall describe the used test procedure and the used test setup.



<b>Conformity</b>	<input type="checkbox"/> <b>OK Fault</b> <input type="checkbox"/> Major <input type="checkbox"/> Minor, define fail reason in comments		
<b>Comments</b>	If possible describe if fault can be fixed with software update: <input type="checkbox"/> <b>YES</b> <input type="checkbox"/> <b>NO</b> Describe more specific faults and/or other information		
<b>Date</b>		<b>Sign</b>	

<b>Test Case</b>	<b>Task 7:33 Loudness levels - Audio Output Levels</b>																				
<b>Section</b>	NorDig Unified 6.13.3																				
<b>Requirement</b>	<p>In order to match the loudness of PCM and coded audio streams in a downstream AV receiver, PCM streams at a target reference level of -23 dBFS shall (1) be reduced in level by 8dB before being output on S/PDIF or HDMI to that device. PCM streams at a target reference level of -31 dBFS shall not be increased in level prior to output. When an HDMI Sink device indicates in its E-EDID structure that it supports multichannel audio, then the output should be at a target reference level of -31 dBFS.</p> <p>When an HDMI Sink device indicates in its E-EDID structure that it only supports Basic Audio (i.e. twochannel L-PCM), then the output should be leveled to a target reference level of -23 dBFS.</p> <p>For analog (stereo) outputs, the target reference level should be leveled to -23 dBFS (as measured on a digital signal).</p>																				
<b>IRD Profile(s)</b>	Basic, IRD, FE																				
<b>Test procedure</b>	<p><b>Purpose of test:</b> To verify IRD audio output levels are according to requirement.</p> <p><b>Test procedure:</b></p> <p>Use a test stream with audio encoded in MPEG-1 Layer II at on a beforhand measured integrated level that is approximately -23 LUFS (integrated value, measured according to EBU R 128 or other close standard such as ITU-R BS.1770).</p> <table border="1" data-bbox="386 1308 1310 1899"> <thead> <tr> <th rowspan="2">Available input format</th> <th colspan="2">Measured Output on S/PDIF (Integrated value in LUFS)</th> <th rowspan="2">OK/NOK</th> </tr> <tr> <th>When Stereo is selected (default) – The Target Reference Level is -23 dBFS</th> <th>When Multichannel is selected – The Target Reference Level is -31 dBFS</th> </tr> </thead> <tbody> <tr> <td>MPEG1 layer II i.e. measured to be -23 LUFS</td> <td>-23 LUFS (same as input)</td> <td>-31 LUFS (8 dB attenuation)</td> <td></td> </tr> <tr> <td>AC-3 i.e. measured to be -23 LUFS with dialnorm level set to = -23 dBFS</td> <td>-23 LUFS</td> <td>-31 LUFS</td> <td></td> </tr> <tr> <td>E-AC-3 i.e. measured to be -23 LUFS with dialnorm level set to = -23 dBFS</td> <td>-23 LUFS</td> <td>-31 LUFS</td> <td></td> </tr> </tbody> </table>			Available input format	Measured Output on S/PDIF (Integrated value in LUFS)		OK/NOK	When Stereo is selected (default) – The Target Reference Level is -23 dBFS	When Multichannel is selected – The Target Reference Level is -31 dBFS	MPEG1 layer II i.e. measured to be -23 LUFS	-23 LUFS (same as input)	-31 LUFS (8 dB attenuation)		AC-3 i.e. measured to be -23 LUFS with dialnorm level set to = -23 dBFS	-23 LUFS	-31 LUFS		E-AC-3 i.e. measured to be -23 LUFS with dialnorm level set to = -23 dBFS	-23 LUFS	-31 LUFS	
Available input format	Measured Output on S/PDIF (Integrated value in LUFS)		OK/NOK																		
	When Stereo is selected (default) – The Target Reference Level is -23 dBFS	When Multichannel is selected – The Target Reference Level is -31 dBFS																			
MPEG1 layer II i.e. measured to be -23 LUFS	-23 LUFS (same as input)	-31 LUFS (8 dB attenuation)																			
AC-3 i.e. measured to be -23 LUFS with dialnorm level set to = -23 dBFS	-23 LUFS	-31 LUFS																			
E-AC-3 i.e. measured to be -23 LUFS with dialnorm level set to = -23 dBFS	-23 LUFS	-31 LUFS																			

HE AAC i.e. measured to be -23 LUFS with prog_ref_level set to = -23 dBFS	-23 LUFS	-31 LUFS	
---------------------------------------------------------------------------	----------	----------	--

Available input format	Measured Output on HDMI* (Integrated value in LUFS)		OK/NOK
	When Stereo is selected (default) – The Target Reference Level is -23 dBFS	When Multichannel is selected – The Target Reference Level is -31 dBFS	
MPEG1 layer II i.e. measured to be -23 LUFS	-23 LUFS (same as input)	-31 LUFS (8 dB attenuation)	
AC-3 i.e. measured to be -23 LUFS with dialnorm level set to = -23 dBFS	-23 LUFS	-31 LUFS	
E-AC-3 i.e. measured to be -23 LUFS with dialnorm level set to = -23 dBFS	-23 LUFS	-31 LUFS	
HE AAC i.e. measured to be -23 LUFS with prog_ref_level set to = -23 dBFS	-23 LUFS	-31 LUFS	

\* An audio analyser with HDMI-input is not common. A HDMI-to-S/PDIF-converter might be of use or other type of equipment.

Available input format	Measured Output on S/PDIF (Integrated value in LUFS)		OK/NOK
	When Stereo is selected (default) – The Target Reference Level is -23 dBFS	When Multichannel is selected – The Target Reference Level is -31 dBFS	
MPEG1 layer II i.e. measured to be -23 LUFS	-23 LUFS (same as input)	-31 LUFS (8 dB attenuation)	
AC-3 i.e. measured to be -23 LUFS with dialnorm level set to = -23 dBFS	-23 LUFS	-31 LUFS	



	E-AC-3 i.e. measured to be -23 LUFS with dialnorm level set to = -23 dBFS	-23 LUFS	-31 LUFS	
	HE AAC i.e. measured to be -23 LUFS with prog_ref_level set to = -23 dBFS	-23 LUFS	-31 LUFS	
<p>For analog (stereo) outputs, the target reference level should be leveled to -23 dBFS (as measured on a digital signal).- Make the same tests as “Stereo” as above.</p> <p>Expected result: IRD supports correct loudness levels. Make sure that the audio level drops when changing from “Stereo” mode to “Multichannel” mode and vice versa.</p>				
<b>Test result(s)</b>				
<b>Conformity</b>	<input type="checkbox"/> <b>OK Fault</b> <input type="checkbox"/> Major <input type="checkbox"/> Minor, define fail reason in comments			
<b>Comments</b>	If possible describe if fault can be fixed with software update: <input type="checkbox"/> <b>YES</b> <input type="checkbox"/> <b>NO</b> Describe more specific faults and/or other information			
<b>Date</b>		<b>Sign</b>		



## 2.8 Task 8: Teletext and subtitling

<b>Test Case</b>	<b>Task 8:1 Subtitling - user preferences</b>
<b>Section</b>	NorDig Unified 7.1
<b>Requirement</b>	<p>The IRD shall have user selection of subtitling preferences for 'normal' or 'hard of hearing' subtitles. The user preference settings for subtitling should be common for EBU Teletext subtitling and DVB Subtitling, see section 16 for factory default settings of the subtitling.</p> <p>Note: Correct functionality for the Hard of Hearing/hearing impaired service, requires that the Content Providers delivers this service as a mix of translated subtitling and Hard of Hearing/hearing impaired subtitling.</p>
<b>IRD Profile(s)</b>	Basic, IRD, FE
<b>Test procedure</b>	This is a general requirement which will be verified in the following test tasks

<b>Test Case</b>	<b>Task 8:2 Subtitling - Only display subtitling if match language in user preferences</b>
<b>Section</b>	NorDig Unified 7.1.2
<b>Requirement</b>	<p>The NorDig IRD shall only display subtitles, if a language of the received subtitle matches any of the NorDig IRD's user preference settings for language for subtitling. (This means that if none of languages for the received subtitle(s) match any of the IRD's user preference settings language for subtitling, then the NorDig IRD shall not display any subtitles).</p>
<b>IRD Profile(s)</b>	Basic, IRD, FE
<b>Test procedure</b>	<p><b>Purpose of test:</b> To verify that the IRD only display subtitles, if a language of the received subtitle matches any of the IRD's user preference settings for language for subtitling.</p> <p><b>Equipment:</b></p> <pre> graph LR     A[MPEG 2-source] --- B[DVB-S/C/T Modulator]     B --- C[Up Converter]     C --- D[DVB Receiver]     D --- E[Monitor]   </pre> <p><b>Test signal configuration:</b> A transport stream is used as a test signal. Within transport stream at least two services are carried with subtitling components. One of the services shall match with the subtitling language settings in IRD and the other service is not matching to any language settings.</p> <p><b>Test procedure:</b></p> <ol style="list-style-type: none"> <li>1. Tune IRD to a service that includes subtitling service that matches the IRD language settings.</li> <li>2. Verify that the correct subtitling is selected</li> <li>3. Tune IRD to a service that includes subtitling service that DO NOT match the IRD language settings.</li> <li>4. Verify that the NO subtitling is selected</li> </ol> <p><b>Expected results:</b> The IRD do not display any subtiling if the user preference's subtitling language do not match with the broadcasted subtitling languages.</p>

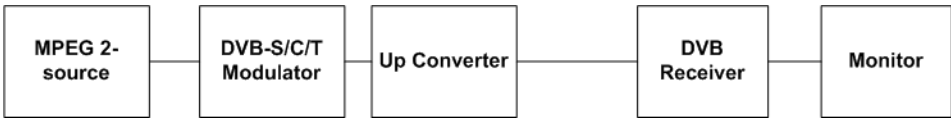

<b>Test result(s)</b>	
<b>Conformity</b>	<input type="checkbox"/> <b>OK Fault</b> <input type="checkbox"/> Major <input type="checkbox"/> Minor, define fail reason in comments
<b>Comments</b>	If possible describe if fault can be fixed with software update: <input type="checkbox"/> <b>YES</b> <input type="checkbox"/> <b>NO</b> Describe more specific faults and/or other information
<b>Date</b>	<b>Sign</b>

<b>Test Case</b>	<b>Task 8:3 Subtitling - Temporary changes to subtitling settings</b>
<b>Section</b>	NorDig Unified 7.1.3
<b>Requirement</b>	In case of the user has made temporary changes of the subtitling settings (i.e. without changing the IRD's user preference setting), then this change shall (at least) remain until the user change service. (Clarification, this means the IRD shall not change back temporary subtitling setting based on EIT events for the service).
<b>IRD Profile(s)</b>	Basic, IRD, FE
<b>Test procedure</b>	<p><b>Purpose of test:</b> To verify that the IRD supports temporary chaging of the subtitling settings.</p> <p><b>Equipment:</b></p>  <pre> graph LR     A[MPEG 2-source] --- B[DVB-S/C/T Modulator]     B --- C[Up Converter]     C --- D[DVB Receiver]     D --- E[Monitor]     </pre> <p><b>Test signal configuration:</b> A transport stream is used as a test signal. Within transport stream at least two services are carried with several subtitling components in several languages. At least in one of the services shall match with the subtitling language settings in IRD and the other service is not matching to any language settings.</p> <p><b>Test procedure:</b></p> <ol style="list-style-type: none"> <li>1. Tune IRD to a service that includes subtitling service that matches the IRD language settings.</li> <li>2. Verify that the correct subtitling is selected</li> <li>3. Change the temporary subtitling setting to anoter language</li> <li>4. Verify that subtitling language is selected according the temporary settings.</li> <li>5. Tune IRD to a service that includes subtitling service that DO NOT match the IRD language settings.</li> <li>6. Verify that the NO subtitling is selected</li> <li>7. Tune IRD to a service that includes subtitling service that matches the IRD language settings.</li> <li>8. Verify that the correct subtitling is selected</li> </ol> <p><b>Expected results:</b> The IRD supports temporary subtitling language settings.</p>
<b>Test result(s)</b>	
<b>Conformity</b>	<input type="checkbox"/> <b>OK Fault</b> <input type="checkbox"/> Major <input type="checkbox"/> Minor, define fail reason in comments
<b>Comments</b>	If possible describe if fault can be fixed with software update: <input type="checkbox"/> <b>YES</b> <input type="checkbox"/> <b>NO</b> Describe more specific faults and/or other information

<i>Date</i>	<i>Sign</i>
-------------	-------------

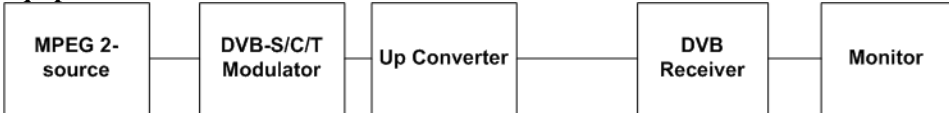
<i>Test Case</i>	<b>Task 8:4 Subtitling – Subtitling mode (Normal and Hard of hearing subtitling)</b>
<i>Section</i>	NorDig Unified 7.1.4
<i>Requirement</i>	<p>In case of ‘normal’ subtitling mode is selected, then the NorDig IRD shall (1) only display ‘normal’ subtitles (signalised in subtitling descriptor and/or teletext descriptor). In this ‘normal’ subtitling mode the NorDig IRD shall not display any (hard or hearing) subtitling if the subtitling stream only includes ‘hard of hearing’/‘hearing impaired’ pages.</p> <p>In case of ‘hard of hearing’ subtitling mode is selected and if no ‘hard of hearing’/‘hearing impaired’ pages are received (signalised in subtitling descriptor and/or teletext descriptor), then the NorDig IRD shall as a default use ‘normal’ subtitling pages from the same selected language.</p>
<i>IRD Profile(s)</i>	Basic, IRD, FE
<i>Test procedure</i>	<p><b>Purpose of test:</b> To verify that the IRD can handle signalisation and decoding of “hard of hearing” subtitling when they are broadcasted.or not. To check that composition pages “normal” are chosen by default instead of “hard of hearing”.</p> <p>Support for ancillary pages is not tested.</p> <p><b>Equipment:</b></p>  <pre> graph LR     A[MPEG 2-source] --- B[DVB-S/C/T Modulator]     B --- C[Up Converter]     C --- D[DVB Receiver]     D --- E[Monitor]   </pre> <p>A transport stream containing a test services with DVB and EBU Teletext composition subtitling and “hard of hearing” components.</p> <p>Subtitling composition pages can be divided into two contents: “normal” or “hard of hearing”. Composition pages shall be enabled in mode “normal” by default. Subtitling ancillary pages can be broadcasted for more or less like a “raw data”. Ancillary pages shall be enabled by default.</p> <p><b>Test procedure:</b></p> <ol style="list-style-type: none"> <li>1. Verify the “hard of hearing” subtitles are enabled</li> <li>2. Start to broadcast the “hard of hearing” subtitles according to correst PSI/SI signalization.</li> <li>3. Verify receiver is able to handle and decode the “hard of hearing” composition pages.</li> <li>4. Stop the “hard of hearing” subtitling pages broadcasting.</li> <li>5. Start the “normal” subtitling pages broadcast.</li> <li>6. Verify that the receiver automatically starts to decode “normal” subtitling pages.</li> </ol> <p><b>Expected result:</b> Hard of hearing content of the DVB and EBU Teletext subtitling is handled, displayed and decoded correctly.</p> <p>The automatic change from “normal” to “hard of hearing” subtitling pages and vice versa is not requirement in NorDig Unified. However, for convenient use of the subtitling composition pages content, a receiver manufacture may choose to have this support due to that all program content is not “hard of hearing” subtitled.</p>



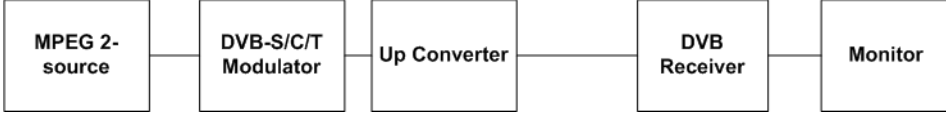

<b>Test result(s)</b>	
<b>Conformity</b>	<input type="checkbox"/> <b>OK Fault</b> <input type="checkbox"/> Major <input type="checkbox"/> Minor, define fail reason in comments
<b>Comments</b>	If possible describe if fault can be fixed with software update: <input type="checkbox"/> <b>YES</b> <input type="checkbox"/> <b>NO</b> Describe more specific faults and/or other information
<b>Date</b>	<b>Sign</b>

<b>Test Case</b>	<b>Task 8:5 Subtitling – DVB Subtitling and subtitling priority (DVB/EBU)</b>
<b>Section</b>	NorDig Unified 7.1.5 and 7.3
<b>Requirement</b>	<p>The NorDig IRD shall be capable of decoding, as a minimum, a subset of the DVB subtitle services as specified in section 7.3.2 and transmitted in conformance with ETS 300 743 [20], and displayed using the OSD capabilities whilst decoding the full television service (video and audio) to which it is associated.</p> <p>The NorDig IRD shall be able to display both ‘normal’ and ‘hard of hearing’ subtitles, according to user preference settings.</p> <p>Within DVB Subtitling it is possible to transmit common pages for all languages and subtitling streams inside one DVB subtitling PID, this is referred to as ‘ancillary pages’. Support for ancillary pages is optional for NorDig IRD. The enabling or disabling of the subtitle ancillary pages, if available, should be user controlled, with subtitle ancillary pages enabled as default option. The selection of subtitle ancillary pages shall be independent of the enabling of subtitle composition pages.</p> <p><b>The precision of the presentation of the subtitles shall be within 2 frames.</b></p>
<b>IRD Profile(s)</b>	Basic, IRD, FE
<b>Test procedure</b>	<p><b>Purpose of test:</b> To verify that DVB subtitling is implemented, and that it has higher priority than Teletext subtitling.</p> <p><b>Equipment:</b></p>  <pre> graph LR     A[MPEG 2-source] --- B[DVB-S/C/T Modulator]     B --- C[Up Converter]     C --- D[DVB Receiver]     D --- E[Monitor]     </pre> <p>A transport stream containing a test service with teletext subtitling and DVB subtitling components.</p> <p><b>Test procedure:</b></p> <ol style="list-style-type: none"> <li>Drop the DVB subtitling component in the mux. Only Teletext subtitling is broadcasted.</li> <li>Zap from, then to, the test service to make sure that the IRD has updated the PMT.</li> <li>Verify that the Teletext subtitling is displayed. Fill in the test protocol.</li> <li>Add the DVB Subtitling component in the mux. Both DVB and Teletext is now present.</li> <li>Verify that the DVB subtitling is the only component that the IRD displays. Fill in the test protocol.</li> <li>Verify that the DVB subtitling is in synchronisation with the video for both SD and HD services for a longer period of time, eg. 45 minutes.. Fill in the test protocol.</li> <li>Enter the language set up and select a subtitling language that is not available</li> </ol>

	<p>as primary subtitling language, but as secondary subtitling language.</p> <ol style="list-style-type: none"> <li>8. Verify that the secondary DVB language is displayed, and in sync with the video.</li> <li>9. Access the menu system for subtitling preferences.</li> <li>10. Verify the “normal” DVB subtitling can be enabled and disabled. Verify the functionality. (In case of teletext subtitles are still broadcasted, the decoding of the teletext subtitles should start)</li> </ol> <p>Expected result: All test results are OK.</p>																			
<b>Test result(s)</b>	<p><b>Test protocol</b></p> <p>Test point 3</p> <table border="1"> <thead> <tr> <th>Expected result</th> <th>OK or NOK</th> </tr> </thead> <tbody> <tr> <td>Teletext subtitling is displayed.</td> <td></td> </tr> </tbody> </table> <p>Test point 6-7</p> <table border="1"> <thead> <tr> <th>Information about the used DVB Subtitling transportstream (ref, subtitle generator info etc)</th> <th>Expected result</th> <th>OK or NOK</th> </tr> </thead> <tbody> <tr> <td></td> <td>DVB subtitling is the only component that is displayed.</td> <td></td> </tr> <tr> <td></td> <td>DVB subtitling is in sync with the video and audio</td> <td></td> </tr> </tbody> </table> <p>Test point 9</p> <table border="1"> <thead> <tr> <th>Expected result</th> <th>OK or NOK</th> </tr> </thead> <tbody> <tr> <td>DVB subtitling can be enabled and disabled.</td> <td></td> </tr> <tr> <td>DVB subtitling is enabled as default</td> <td></td> </tr> </tbody> </table>	Expected result	OK or NOK	Teletext subtitling is displayed.		Information about the used DVB Subtitling transportstream (ref, subtitle generator info etc)	Expected result	OK or NOK		DVB subtitling is the only component that is displayed.			DVB subtitling is in sync with the video and audio		Expected result	OK or NOK	DVB subtitling can be enabled and disabled.		DVB subtitling is enabled as default	
Expected result	OK or NOK																			
Teletext subtitling is displayed.																				
Information about the used DVB Subtitling transportstream (ref, subtitle generator info etc)	Expected result	OK or NOK																		
	DVB subtitling is the only component that is displayed.																			
	DVB subtitling is in sync with the video and audio																			
Expected result	OK or NOK																			
DVB subtitling can be enabled and disabled.																				
DVB subtitling is enabled as default																				
<b>Conformity</b>	<input type="checkbox"/> <b>OK</b> <input type="checkbox"/> <b>Fault</b> <input type="checkbox"/> Major <input type="checkbox"/> Minor, define fail reason in comments																			
<b>Comments</b>	<p>If possible describe if fault can be fixed with software update: <input type="checkbox"/> <b>YES</b> <input type="checkbox"/> <b>NO</b></p> <p>Describe more specific faults and/or other information</p>																			
<b>Date</b>	<table border="1"> <tr> <td style="width: 50%;"></td> <td style="width: 20%; text-align: center;"><i>Sign</i></td> <td style="width: 30%;"></td> </tr> </table>		<i>Sign</i>																	
	<i>Sign</i>																			

<b>Test Case</b>	<b>Task 8:6 Teletext - Simultaneous EBU Teletext and HbbTV Digital Teletext</b>
<b>Section</b>	NorDig Unified 7.1.6
<b>Requirement</b>	<p>For services that have both an EBU Teletext service and an HbbTV Digital Teletext application signalled and available, the NorDig Hybrid shall (1) be able to start and display the HbbTV Digital Teletext application as well as being able to start and display the EBU Teletext service (one at a time).</p> <p>The NorDig Hybrid shall (1) start teletext and be able to toggle between any HbbTV Digital Teletext and any EBU Teletext service as described in clause 5.3.4 of HbbTV</p>

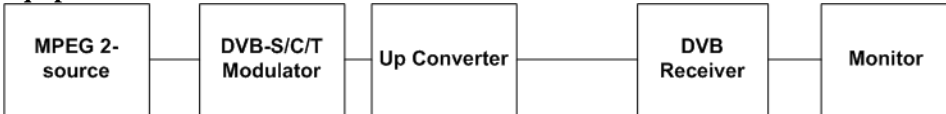
	specification ETSI TS 102 796
<b>IRD Profile(s)</b>	Basic, IRD, FE
<b>Test procedure</b>	<p><b>Purpose of test:</b> To verify that the IRD is able to start EBU Teletext and HbbTV Digital Teletext (one at the time).</p> <p><b>Equipment:</b></p>  <pre> graph LR     A[MPEG 2-source] --- B[DVB-S/C/T Modulator]     B --- C[Up Converter]     C --- D[DVB Receiver]     D --- E[Monitor]   </pre> <p>A transport stream containing a test services with EBU Teletext and HbbTV Digital Teletext application.</p> <p><b>Test procedure:</b></p> <ol style="list-style-type: none"> <li>1. Tune to a serve that contains both EBU Teletext and HbbTV Digital Teletext application.</li> <li>2. Verify that the user can toggle between EBU Teletext and HbbTV Digital Teletext application by pressing the “text” button in the RCU.</li> </ol> <p><b>Expected result:</b> User can toggle between EBU Teletext and HbbTV Digital Teletext application.</p>
<b>Test result(s)</b>	
<b>Conformity</b>	<input type="checkbox"/> <b>OK</b> <input type="checkbox"/> <b>Fault</b> <input type="checkbox"/> Major <input type="checkbox"/> Minor, define fail reason in comments
<b>Comments</b>	If possible describe if fault can be fixed with software update: <input type="checkbox"/> <b>YES</b> <input type="checkbox"/> <b>NO</b> Describe more specific faults and/or other information
<b>Date</b>	<b>Sign</b>

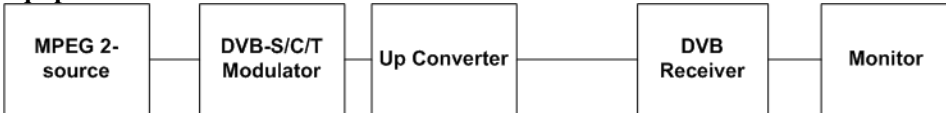
<b>Test Case</b>	<b>Task 8:7 Subtitling - coexistent with HbbTV applications</b>
<b>Section</b>	NorDig Unified 7.1.7
<b>Requirement</b>	<p>A NorDig Hybrid shall support simultaneous display of HbbTV application and subtitles (DVB subtitling and EBU teletext subtitling), both for broadcast and at least for MPEG2 TS delivered via broadband [29].</p> <p>The NorDig Hybrid shall display the HbbTV application over the subtitles as described in clause 10.1.1 of HbbTV specification ETSI TS 102 796 [30]. This means that if the video is up or down-converted, to other than full screen video, the subtitles shall either be rescaled/repositioned appropriately or not displayed at all.</p>
<b>IRD Profile(s)</b>	Hybrid, IRD, FE
<b>Test procedure</b>	<p><b>Purpose of test:</b> To verify that DVB and EBU teletext subtitling can coexists with HbbTV applications.</p> <p><b>Equipment:</b></p>  <pre> graph LR     A[MPEG 2-source] --- B[DVB-S/C/T Modulator]     B --- C[Up Converter]     C --- D[DVB Receiver]     D --- E[Monitor]   </pre> <p>A transport stream containing a test service with DVB and EBU teletext composition</p>

	subtitling component and at least one signaled service bound HbbTV application at the same channel.  <b>Test procedure:</b> <ol style="list-style-type: none"> <li>1. set the IRD to the autostart mode for the HbbTV services and ensure that subtitles are enabled</li> <li>2. search channels</li> <li>3. zap to a channel that contains the HbbTV service and subtitles</li> <li>4. verify that when the HbbTV application is not using the same graphics plane or area of the plane as the subtitles, the subtitles are visible</li> </ol> <b>Expected result:</b> The subtitles are visible with a HbbTV application, when they are not sharing the same area of the graphics plane.	
<i>Test result(s)</i>		
<i>Conformity</i>	<input type="checkbox"/> <b>OK Fault</b> <input type="checkbox"/> Major <input type="checkbox"/> Minor, define fail reason in comments	
<i>Comments</i>	If possible describe if fault can be fixed with software update: <input type="checkbox"/> <b>YES</b> <input type="checkbox"/> <b>NO</b> Describe more specific faults and/or other information	
<i>Date</i>		<i>Sign</i>

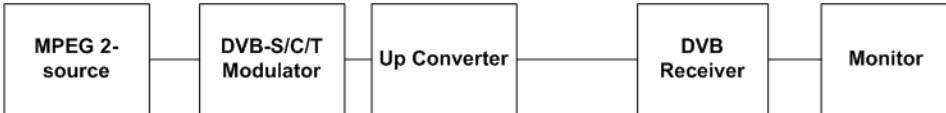
<i>Test Case</i>	<b>Task 8:8 Teletext – EBU Teletext level 1.5</b>	
<i>Section</i>	NorDig Unified 7.2	
<i>Requirement</i>	Level 1.5 teletext and teletext subtitling is displayed.	
<i>IRD Profile(s)</i>	Basic, IRD, FE	
<i>Test procedure</i>	<b>Purpose of test:</b> To check that enhanced teletext (Level 1.5) is decoded and displayed.  <b>Equipment:</b> <div style="text-align: center; margin: 10px 0;">  <pre> graph LR     A[MPEG 2-source] --- B[DVB-S/C/T Modulator]     B --- C[Up Converter]     C --- D[DVB Receiver]     D --- E[Monitor]           </pre> </div> <b>Test signal configuration:</b> A transport stream is used as a test signal. Within transport stream at least one service is carried with teletext component. Teletext pages and teletext subtitles shall be ITU-R System B Teletext level 1.5 compatible.  <b>Test procedure:</b> The IRD is tuned to a service that includes ITU-R System B Teletext (Level 1.5). The teletext service is selected.	
<i>Test result(s)</i>		
<i>Conformity</i>	<input type="checkbox"/> <b>OK Fault</b> <input type="checkbox"/> Major <input type="checkbox"/> Minor, define fail reason in comments	
<i>Comments</i>	If possible describe if fault can be fixed with software update: <input type="checkbox"/> <b>YES</b> <input type="checkbox"/> <b>NO</b> Describe more specific faults and/or other information	
<i>Date</i>		<i>Sign</i>

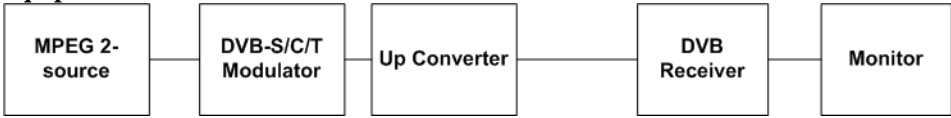
<b>Test Case</b>	<b>Task 8:9 Teletext - decoding method(VBI)</b>							
<b>Section</b>	NorDig Unified 7.2.2							
<b>Requirement</b>	The NorDig IRD shall for the analogue outputs also support insertion of the teletext data in the VBI of the analogue CVBS video output. In this case the teletext decoder of the TV-set might be used instead of the one in the STB. The VBI insertion shall be compliant with ITU-R BT.653-3 [64]. The Teletext data shall be inserted in the lines 6 to 22 and lines 320 to 335..							
<b>IRD Profile(s)</b>	Basic, IRD, FE							
<b>Test procedure</b>	<p><b>Purpose of test:</b> To verify that ITU-R System B Teletext data is inserted in the VBI of the analogue CVBS video output and/or it is decoded and displayed in the OSD.</p> <p><b>Equipment:</b></p>  <pre> graph LR     A[MPEG 2-source] --- B[DVB-S/C/T Modulator]     B --- C[Up Converter]     C --- D[DVB Receiver]     D --- E[Monitor]     </pre> <p><b>Test procedure:</b></p> <ol style="list-style-type: none"> <li>1. The IRD is tuned to a TV service that includes ITU-R System B Teletext.</li> <li>2. Verify that teletext data is inserted onto VBI lines within the range 6-22 and 320-335.</li> </ol> <p>In case of a STB an external TV monitor with embedded teletext decoder is used to decode the Teletext service. In case of an idTV an separate TV monitor with embedded teletext decoder can be used to decode the Teletext service from the analog video output.</p> <p><b>Expected results:</b> Teletext data is inserted onto VBI lines within the range 6-22 and 320-335.</p>							
<b>Test result(s)</b>	<p>Test protocol</p> <table border="1"> <thead> <tr> <th>Requirement</th> <th>NOK or OK</th> </tr> </thead> <tbody> <tr> <td>VBI of CVBS video insertion supported for teletext pages</td> <td></td> </tr> <tr> <td>VBI of CVBS video insertion supported for teletext subtitles</td> <td></td> </tr> </tbody> </table>		Requirement	NOK or OK	VBI of CVBS video insertion supported for teletext pages		VBI of CVBS video insertion supported for teletext subtitles	
Requirement	NOK or OK							
VBI of CVBS video insertion supported for teletext pages								
VBI of CVBS video insertion supported for teletext subtitles								
<b>Conformity</b>	<input type="checkbox"/> <b>OK Fault</b> <input type="checkbox"/> Major <input type="checkbox"/> Minor, define fail reason in comments							
<b>Comments</b>	<p>If possible describe if fault can be fixed with software update: <input type="checkbox"/> <b>YES</b> <input type="checkbox"/> <b>NO</b> Describe more specific faults and/or other information</p>							
<b>Date</b>		<b>Sign</b>						

<b>Test Case</b>	<b>Task 8:10 Teletext decoding method(OSD)</b>	
<b>Section</b>	NorDig Unified 7.2.1	
<b>Requirement</b>	<p>During normal operation, the NorDig IRD shall be able to demultiplex in parallel the Teletext service transmitted in a packetised format according EN 300 472 [17].</p> <p>The NorDig IRD shall include a teletext decoder to be able to display EBU Teletext using the OSD.</p>	

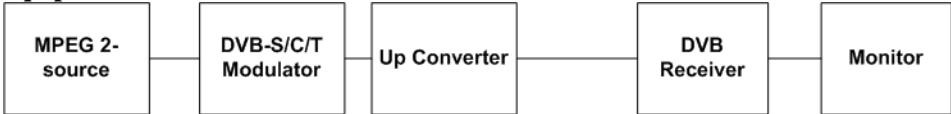

<b>IRD Profile(s)</b>	Basic, IRD, FE						
<b>Test procedure</b>	<p><b>Purpose of test:</b> To verify that EN 300 472 [17] data is is decoded and displayed in the OSD.</p> <p><b>Equipment:</b></p>  <pre> graph LR     A[MPEG 2-source] --- B[DVB-S/C/T Modulator]     B --- C[Up Converter]     C --- D[DVB Receiver]     D --- E[Monitor]             </pre> <p><b>Test procedure:</b></p> <ol style="list-style-type: none"> <li>The IRD is tuned to a TV service that includes ITU-R System B Teletext.</li> <li>Verify that OSD decoding method is supported, verify the teletext is correctly decoded on the OSD.</li> </ol> <p><b>Expected results:</b> Receiver supports the teletext decoding in the OSD.</p>						
<b>Test result(s)</b>	<p>Test protocol</p> <table border="1"> <thead> <tr> <th>Requirement</th> <th>NOK or OK</th> </tr> </thead> <tbody> <tr> <td>OSD decoding supported for teletext pages</td> <td></td> </tr> <tr> <td>OSD decoding supported for teletext subtitles</td> <td></td> </tr> </tbody> </table>	Requirement	NOK or OK	OSD decoding supported for teletext pages		OSD decoding supported for teletext subtitles	
Requirement	NOK or OK						
OSD decoding supported for teletext pages							
OSD decoding supported for teletext subtitles							
<b>Conformity</b>	<input type="checkbox"/> <b>OK Fault</b> <input type="checkbox"/> Major <input type="checkbox"/> Minor, define fail reason in comments						
<b>Comments</b>	<p>If possible describe if fault can be fixed with software update: <input type="checkbox"/> YES <input type="checkbox"/> NO</p> <p>Describe more specific faults and/or other information</p>						
<b>Date</b>	<table border="1"> <tr> <td style="width: 50%;"></td> <td style="width: 10%; text-align: center;"><i>Sign</i></td> <td style="width: 40%;"></td> </tr> </table>		<i>Sign</i>				
	<i>Sign</i>						

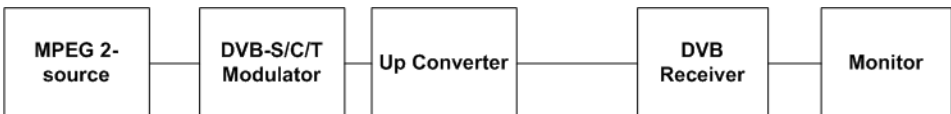
<b>Test Case</b>	<b>Task 8:11 Teletext – teletext pages</b>
<b>Section</b>	NorDig Unified 7.2.1
<b>Requirement</b>	The Nordic characters defined in the Latin G2 supplementary set shall be supported.
<b>IRD Profile(s)</b>	Basic, IRD, FE
<b>Test procedure</b>	<p><b>Purpose of test:</b> To test the functionality of the teletext decoder concerning teletext pages.</p> <p><b>Equipment:</b></p>  <pre> graph LR     A[MPEG 2-source] --- B[DVB-S/C/T Modulator]     B --- C[Up Converter]     C --- D[DVB Receiver]     D --- E[Monitor]             </pre> <p><b>Test procedure:</b></p> <p>Start condition: IRD installed on the live network</p> <ol style="list-style-type: none"> <li>Check the teletext function on several services and make sure that it works properly.</li> </ol>

	<ol style="list-style-type: none"> <li>2. Fill in the test protocol.</li> <li>3. Zap to a service with multiple initial pages in different languages. Select an available language as primary language.</li> <li>4. Verify that the correct initial page is displayed when txt-button is pressed.</li> <li>5. Fill in the test protocol.</li> <li>6. Repeat 3-4 for another language</li> </ol> <p><b>Expected result:</b> All test results are OK.</p>																
<i>Test result(s)</i>	<p><b>Test protocol:</b></p> <p style="text-align: center;"><i>Test point 1</i></p> <table border="1" style="width: 100%; border-collapse: collapse;"> <thead> <tr style="background-color: #333; color: white;"> <th style="width: 80%;">Expected result</th> <th style="width: 20%;">OK or NOK</th> </tr> </thead> <tbody> <tr> <td>Teletext works without any problems.</td> <td></td> </tr> </tbody> </table> <p style="text-align: center;"><i>Test point 2-4</i></p> <table border="1" style="width: 100%; border-collapse: collapse;"> <thead> <tr style="background-color: #333; color: white;"> <th style="width: 20%;">Primary language</th> <th style="width: 50%;">Expected result</th> <th style="width: 30%;">OK or NOK</th> </tr> </thead> <tbody> <tr> <td>swe</td> <td>The initial teletext page is displayed in swedish</td> <td></td> </tr> <tr> <td></td> <td>The initial teletext page is displayed in the selected language</td> <td></td> </tr> <tr> <td></td> <td>The initial teletext page is displayed in the selected language</td> <td></td> </tr> </tbody> </table>	Expected result	OK or NOK	Teletext works without any problems.		Primary language	Expected result	OK or NOK	swe	The initial teletext page is displayed in swedish			The initial teletext page is displayed in the selected language			The initial teletext page is displayed in the selected language	
Expected result	OK or NOK																
Teletext works without any problems.																	
Primary language	Expected result	OK or NOK															
swe	The initial teletext page is displayed in swedish																
	The initial teletext page is displayed in the selected language																
	The initial teletext page is displayed in the selected language																
<i>Conformity</i>	<input type="checkbox"/> <b>OK</b> <input type="checkbox"/> <b>Fault</b> <input type="checkbox"/> Major <input type="checkbox"/> Minor, define fail reason in comments																
<i>Comments</i>	If possible describe if fault can be fixed with software update: <input type="checkbox"/> <b>YES</b> <input type="checkbox"/> <b>NO</b> Describe more specific faults and/or other information																
<i>Date</i>	<i>Sign</i>																

<i>Test Case</i>	<b>Task 8:12 Teletext – teletext pages - cache</b>
<i>Section</i>	NorDig Unified 7.2.1
<i>Requirement</i>	The NorDig IRD with OSD presentation shall be able to cache at least 200 decoded Teletext pages in order to improve the access time for frequently used pages.
<i>IRD Profile(s)</i>	Basic, IRD, FE
<i>Test procedure</i>	<p><b>Purpose of test:</b> To test the functionality of the teletext decoder concerning teletext page cache.</p> <p><b>Equipment:</b></p>

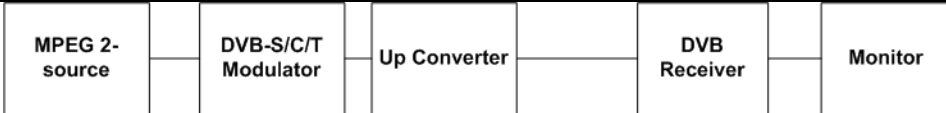
			
	<p>TS contains a service with at least 200 EBU teletext pages.</p> <p><b>Test procedure:</b></p> <ol style="list-style-type: none"> <li>1. Check the teletext function on several services and estimate that teletext cache is at least 200 pages.</li> </ol> <p><b>Expected result:</b> All test results are OK.</p>		
<b>Test result(s)</b>			
<b>Conformity</b>	<input type="checkbox"/> OK <input type="checkbox"/> Fault <input type="checkbox"/> Major <input type="checkbox"/> Minor, define fail reason in comments		
<b>Comments</b>	<p>If possible describe if fault can be fixed with software update: <input type="checkbox"/> YES <input type="checkbox"/> NO</p> <p>Describe more specific faults and/or other information</p>		
<b>Date</b>		<b>Sign</b>	

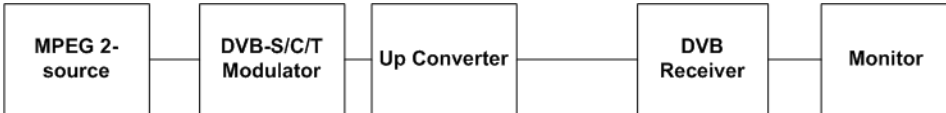
<b>Test Case</b>	<b>Task 8:13 Subtitling – teletext subtitling</b>
<b>Section</b>	NorDig Unified 7.1, 7,2
<b>Requirement</b>	<p>DVB Subtitling and Teletext Subtitling are mandatory in the NorDig IRDs. The user shall be able to enable and disable displaying of subtitles and to select primary and secondary subtitling language.</p> <p>The Nordic characters defined in the Latin G2 supplementary set shall be supported.</p>
<b>IRD Profile(s)</b>	Basic, IRD, FE
<b>Test procedure</b>	<p><b>Purpose of test:</b> To test the functionality of the teletext decoder concerning subtitling.</p> <p><b>Equipment:</b></p>  <p><b>Test procedure:</b></p> <p>Start condition: IRD installed on the network</p> <ol style="list-style-type: none"> <li>1. Enter the menu and check that it's possible to select primary and secondary subtitling language. Fill in the test protocol.</li> <li>2. Zap to a service with multiple subtitle languages. Select an available language as primary language and check that the subtitling is displayed.</li> <li>3. Verify that the text is in sync with the video for both SD and HD services for a</li> </ol>

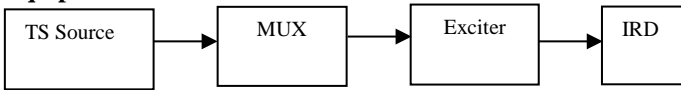

	<p>longer period of time, eg. 45 minutes.</p> <ol style="list-style-type: none"> <li>4. Verify that the nordic characters are displayed correctly.</li> <li>5. Fill in the results in the protocol.</li> <li>6. Enter the language set up and select a language that is not available as primary language, but as secondary language.</li> <li>7. Verify that the secondary language text is displayed, and in sync with the video.</li> <li>8. Verify that the nordic characters are displayed correctly.</li> <li>9. Fill in the results in the protocol.</li> </ol> <p>Repeat 6-9 for the other subtitling languages and fill in the protocol.</p> <p><b>Expected result:</b> All test results are OK.</p>																																
<b>Test result(s)</b>	<p><b>Test protocol:</b></p> <p>Test point 1</p> <table border="1" style="width: 100%; border-collapse: collapse;"> <thead> <tr style="background-color: #333; color: white;"> <th style="width: 70%;">Expected result</th> <th style="width: 30%;">OK or NOK</th> </tr> </thead> <tbody> <tr> <td>It's possible to select primary and secondary language.</td> <td style="text-align: center;"> </td> </tr> </tbody> </table> <p>Test point 2-10</p> <table border="1" style="width: 100%; border-collapse: collapse;"> <thead> <tr style="background-color: #333; color: white;"> <th style="width: 15%;">Primary subtitling language</th> <th style="width: 15%;">Secondary subtitling language</th> <th style="width: 50%;">Expected result</th> <th style="width: 20%;">OK or NOK</th> </tr> </thead> <tbody> <tr> <td rowspan="2">swe</td> <td rowspan="2">Set to non valid language</td> <td>Subtitling displayed in sync with video</td> <td style="text-align: center;"> </td> </tr> <tr> <td>Nordic characters displayed correctly</td> <td style="text-align: center;"> </td> </tr> <tr> <td rowspan="2">Set to non valid language</td> <td rowspan="2"> </td> <td>Subtitling displayed in sync with video</td> <td style="text-align: center;"> </td> </tr> <tr> <td>Nordic characters displayed correctly</td> <td style="text-align: center;"> </td> </tr> <tr> <td rowspan="2">Set to non valid language</td> <td rowspan="2"> </td> <td>Subtitling displayed in sync with video</td> <td style="text-align: center;"> </td> </tr> <tr> <td>Nordic characters displayed correctly</td> <td style="text-align: center;"> </td> </tr> <tr> <td rowspan="2">Set to non valid language</td> <td rowspan="2"> </td> <td>Subtitling displayed in sync with video</td> <td style="text-align: center;"> </td> </tr> <tr> <td>Nordic characters displayed correctly</td> <td style="text-align: center;"> </td> </tr> </tbody> </table>	Expected result	OK or NOK	It's possible to select primary and secondary language.		Primary subtitling language	Secondary subtitling language	Expected result	OK or NOK	swe	Set to non valid language	Subtitling displayed in sync with video		Nordic characters displayed correctly		Set to non valid language		Subtitling displayed in sync with video		Nordic characters displayed correctly		Set to non valid language		Subtitling displayed in sync with video		Nordic characters displayed correctly		Set to non valid language		Subtitling displayed in sync with video		Nordic characters displayed correctly	
Expected result	OK or NOK																																
It's possible to select primary and secondary language.																																	
Primary subtitling language	Secondary subtitling language	Expected result	OK or NOK																														
swe	Set to non valid language	Subtitling displayed in sync with video																															
		Nordic characters displayed correctly																															
Set to non valid language		Subtitling displayed in sync with video																															
		Nordic characters displayed correctly																															
Set to non valid language		Subtitling displayed in sync with video																															
		Nordic characters displayed correctly																															
Set to non valid language		Subtitling displayed in sync with video																															
		Nordic characters displayed correctly																															
<b>Conformity</b>	<input type="checkbox"/> <b>OK</b> <input type="checkbox"/> <b>Fault</b> <input type="checkbox"/> Major <input type="checkbox"/> Minor, define fail reason in comments																																
<b>Comments</b>	<p>If possible describe if fault can be fixed with software update: <input type="checkbox"/> <b>YES</b> <input type="checkbox"/> <b>NO</b></p> <p>Describe more specific faults and/or other information</p>																																
<b>Date</b>	<table border="1" style="width: 100%; border-collapse: collapse;"> <tr> <td style="width: 50%;"></td> <td style="width: 50%; text-align: center;"><i>Sign</i></td> </tr> </table>		<i>Sign</i>																														
	<i>Sign</i>																																
<b>Test Case</b>	<b>Task 8:14 Subtitling – DVB Subtitling</b>																																
<b>Section</b>	NorDig Unified 7.3.2																																

<p><b>Requirement</b></p>	<p><b>DDS:</b> The Display Definition Segment for a subtitle service shall be supported for services that implement DDS, as defined in EN 300 743 [13]. Absence of a DDS implies that the display segment width shall be assumed as 720 pixels and the height as 576 lines.</p> <p>The NorDig IRD shall at least be capable of decoding the following DVB subtitling services:</p> <p><b>Object types:</b> The handling of the object type (0x00) ‘basic object, bitmap’ shall be supported. The handling of the other object types (i.e. 0x01), ‘basic object, character’ and (0x02) ‘composite object, string of characters’) is optional.</p> <p><b>Regions:</b> The number of regions shall be according to the ETS 300 743 [22] specification, however a limitation in the display area due to memory restrictions is allowed. The total number of regions to handle shall be able to cover four complete subtitle rows (per frame) where one subtitle row shall be extendable to 1906 pixels * 60 pixels. The regions shall have the possibility to cover 457440 pixels per frame.</p> <p><b>Number of objects:</b> The number of objects shall be at least 128.</p> <p><b>CLUT:</b> The NorDig IRD receiver shall be able to handle at least one colour look-up table (CLUT) with a minimum of 16 entries per region and the possibility to have one colour scheme applied in each of the regions. It shall be possible to choose any 24-bit RGB colour into the 16 entries. The decoder shall be able to handle the mapping to the closest colour match if the decoder has some limitation in the colour presentation. The use of the non_modifying_colour flag is optional.</p> <p><b>Transparency:</b> The NorDig IRD receiver shall implement at least 5 levels of transparency; 0% (opaque), 30%, 50%, 70% and 100% (completely transparent). Implementation of additional intermediate levels of transparency is optional. Where the NorDig IRD cannot complement a particular value of semitransparency it shall replace it with the nearest value of transparency it can implement. However, if the encoded value of transparency is in the range 10%-90% it shall not be approximated as either 0% or 100% transparency. So, 9% may be approximated as 0% but 10% shall be represented with a value in the range 10% to 90%, such as 30%. Similarly, 91% may be approximated as 100%.</p> <p><b>Number of streams:</b> NorDig IRD shall support at least one DVB-subtitling streams i.e. at least support decoding of one subtitling composition page while support of one simultaneously available ancillary page is optional.</p>
<p><b>IRD Profile(s)</b></p>	<p>Basic, IRD, FE</p>
<p><b>Test procedure</b></p>	<p><b>Purpose of test:</b> To check that the different DVB Subtitling services are functional.</p> <p><b>Equipment:</b></p>  <pre> graph LR     TS[TS Source] --&gt; MUX[MUX]     MUX --&gt; Exciter[Exciter]     Exciter --&gt; IRD[IRD]   </pre>



NorDig

	<b>Expected result:</b> Subtitling is displayed as defined in requirements.
<i>Test result(s)</i>	
<i>Conformity</i>	<input type="checkbox"/> <b>OK Fault</b> <input type="checkbox"/> Major <input type="checkbox"/> Minor, define fail reason in comments
<i>Comments</i>	If possible describe if fault can be fixed with software update: <input type="checkbox"/> <b>YES</b> <input type="checkbox"/> <b>NO</b> Describe more specific faults and/or other information
<i>Date</i>	
	<i>Sign</i>

## 2.9 Task 9: Interfaces and Signal Levels

<b>Test Case</b>	<b>Task 9:1 Two-way Interface</b>	
<b>Section</b>	NorDig Unified 8.3	
<b>Requirement</b>	<p>The NorDig IRD with the Hybrid profile or an IP-based front-end shall support at least one of the following interaction channel interfaces:</p> <ol style="list-style-type: none"> <li>1. Ethernet (IEEE 802.3 [47] (100 Base-T, Auto-sense ).</li> <li>2. EuroDocusis in accordance with ITU-J.122 [61] (ref IRDs with a cable front-end).</li> <li>3. Wireless LAN, Ethernet 802.11 n (1) [46]</li> <li>4. Power line [HomePlug AV Specification, IEEE 1901.2010]</li> <li>5. USB 2.0 or higher</li> </ol>	
<b>IRD Profile(s)</b>	Hybrid, IRD, FE	
<b>Test procedure</b>	<p><b>Purpose of test:</b> Verify functionality of interaction channel interface.</p> <p><b>Equipment:</b> Manufacturer describes used test setup and test procedures.</p>	
<b>Test result(s)</b>		
<b>Conformity</b>	<input type="checkbox"/> <b>OK</b> <input type="checkbox"/> <b>Fault</b> <input type="checkbox"/> <b>Major</b> <input type="checkbox"/> <b>Minor</b> , define fail reason in comments	
<b>Comments</b>	<p>If possible describe if fault can be fixed with software update: <input type="checkbox"/> <b>YES</b> <input type="checkbox"/> <b>NO</b></p> <p>Describe more specific faults and/or other information</p>	
<b>Date</b>		<b>Sign</b>

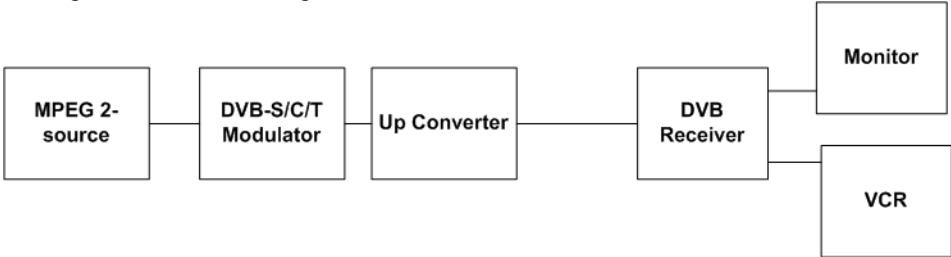
<b>Test Case</b>	<b>Task 9:2 SCART Interface</b>	
<b>Section</b>	NorDig Unified 8.4	
<b>Requirement</b>	<p>The NorDig STB shall (1) have one SCART Interface in accordance with EN 50049-1 [7] and EN 50157-2-1 [9].</p> <p>This requirement is optional from 1<sup>st</sup> January 2014 forwards.</p>	
<b>IRD Profile(s)</b>	Basic, IRD, FE	
<b>Test procedure</b>	<p><b>Purpose of test:</b> Verify that the IRD SCART interface comply with the NorDig Unified requirements.</p> <p>This test is mandatory if the IRD has SCART interface.</p> <p><b>Equipment:</b> Test signals are created using the test bed shown below:</p>  <pre> graph LR     A[MPEG 2-source] --- B[DVB-S/C/T Modulator]     B --- C[Up Converter]     C --- D[DVB Receiver]     D --- E[Monitor]     D --- F[VCR]           </pre> <p>The multiplex should contain a number of services with 4:3 picture aspect ratio, and one</p>	

	<p>service with 16:9 aspect ratio. All services in the multiplex are descrambled before recording. And one of them contains DVB or Teletext subtitles.</p> <p>If the IRD is IDTV, this test is not relevant.</p> <p><b>Test procedure:</b> Verify that IRD has at least one analog video and audio interface with SCART connector.</p> <p>The SCART interface provides analog audio and analog video in CVBS or RGB format.</p> <p>Monitor voltage on pin 8 and pin 16 on SCART when services with 4:3 and 16:9 aspect ratio video is selected.</p> <p><b>Expected results:</b> IRD has at least one analog video and audio output interface with SCART connector.</p> <p>The SCART interface provides analog audio and analog video in CVBS or RGB video format.</p> <p>Signalling in SCART is correct and shows corresponding display formats and subtitles are shown in all SCART connectors.</p>
<i>Test result(s)</i>	
<i>Conformity</i>	<input type="checkbox"/> <b>OK Fault</b> <input type="checkbox"/> Major <input type="checkbox"/> Minor, define fail reason in comments
<i>Comments</i>	If possible describe if fault can be fixed with software update: <input type="checkbox"/> <b>YES</b> <input type="checkbox"/> <b>NO</b> Describe more specific faults and/or other information
<i>Date</i>	<i>Sign</i>

<i>Test Case</i>	<b>Task 9:3 HDMI interface – HD Ready</b>
<i>Section</i>	NorDig Unified 8.6.1
<i>Requirement</i>	<p>The NorDig iDTV with screen diameters 30 cm and above shall have a HDMI input interface in accordance with the DigitalEurope HD-Ready requirements [6] and the High Definition Multimedia Interface [40]. HDMI input interface is highly recommended for iDTV-sets with smaller screen diameters. The HDMI output interface is recommended for iDTV-sets.</p> <p>The NorDig STBs shall have at least one High-Definition Multimedia Interface (HDMI) with type A output connector [40], supporting displays that comply with the DigitalEurope HD-Ready requirements [6] and the High Definition Multimedia Interface [40].</p>
<i>IRD Profile(s)</i>	Basic, IRD, FE
<i>Test procedure</i>	<b>Verify that the IRD has the HD Ready certificate.</b>
<i>Test result(s)</i>	
<i>Conformity</i>	<input type="checkbox"/> <b>OK Fault</b> <input type="checkbox"/> Major <input type="checkbox"/> Minor, define fail reason in comments
<i>Comments</i>	If possible describe if fault can be fixed with software update: <input type="checkbox"/> <b>YES</b> <input type="checkbox"/> <b>NO</b> Describe more specific faults and/or other information

<i>Date</i>	<i>Sign</i>
-------------	-------------

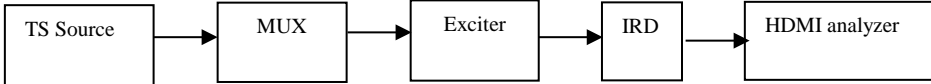
<i>Test Case</i>	<b>Task 9:4 HDMI interface – EDID information</b>
<i>Section</i>	NorDig Unified 8.6.2
<i>Requirement</i>	<p>The NorDig STB shall recognise E-EDID information provided by the display and subsequently follow the below requirements.</p> <p>The NorDig STB shall use 1920x1080p@50 Hz as the default output format, if supported by the display.</p>
<i>IRD Profile(s)</i>	Basic, STB, FE
<i>Test procedure</i>	<p><b>Purpose of test:</b> To verify that the receiver is able to use the EDID information. This test is relevant for STB only.</p> <p>For other IRDs having HDMI output interface this test is optional.</p> <p><b>Equipment:</b></p>  <pre> graph LR     TS[TS Source] --&gt; MUX[MUX]     MUX --&gt; Exc[Exciter]     Exc --&gt; IRD[IRD]     IRD --&gt; Analyzer[HDMI analyzer]   </pre> <p><b>Test procedure:</b></p> <p>Use following supported resolutions and frame rates in the HDMI analyzer for the EDID negotiation:</p> <ul style="list-style-type: none"> <li>• 1280x720p50</li> <li>• 1920x1080i25</li> <li>• 1920x1080p50</li> </ul> <p>Use following supported audio formats in the HDMI analyzer for the EDID negotiation:</p> <ul style="list-style-type: none"> <li>• PCM</li> <li>• AC-3</li> <li>• DTS</li> <li>• E-AC-3</li> </ul> <ol style="list-style-type: none"> <li>1. Set test equipment</li> <li>2. Power On the IRD</li> <li>3. Verify that the IRD can select all display parameters according the EDID information.</li> <li>4. Verify that the IRD can select all audio parameters according the EDID information.</li> </ol> <p><b>Expected result:</b> The IRD uses the EDID information for the video and audio parameters.</p>
<i>Test result(s)</i>	
<i>Conformity</i>	<input type="checkbox"/> OK <input type="checkbox"/> Fault <input type="checkbox"/> Major <input type="checkbox"/> Minor, define fail reason in comments
<i>Comments</i>	If possible describe if fault can be fixed with software update: <input type="checkbox"/> YES <input type="checkbox"/> NO Describe more specific faults and/or other information
<i>Date</i>	<i>Sign</i>

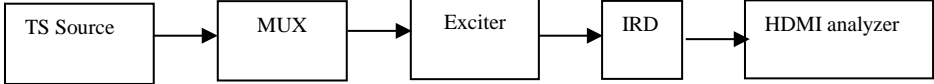
<b>Test Case</b>	<b>Task 9:5 HDMI interface – Original format</b>	
<b>Section</b>	NorDig Unified8.6.2	
<b>Requirement</b>	By choosing an “Original Format” option, i.e. to output the same format as received, if supported by the display. If the received format is not supported, the STB shall select the display mode providing the best possible video quality, as indicated by the E-EDID information. This is to avoid the STB output to go black, if there is a mismatch between received format and display capability.	
<b>IRD Profile(s)</b>	Basic, STB, FE	
<b>Test procedure</b>	<p><b>Purpose of test:</b> To verify that the receiver is able to use the EDID information.</p> <p>This test is relevant for STB only.</p> <p>For other IRDs having HDMI output interface this test is optional.</p> <p><b>Equipment:</b></p>  <pre> graph LR     TS[TS Source] --&gt; MUX[MUX]     MUX --&gt; Exc[Exciter]     Exc --&gt; IRD[IRD]     IRD --&gt; Analyzer[HDMI analyzer]     </pre> <p>Use following resolutions and frame rates in the test stream(s):</p> <ul style="list-style-type: none"> <li>• 720x576i25</li> <li>• 1280x720p50</li> <li>• 1920x1080i25</li> </ul> <p><b>Test procedure:</b> Play a test stream Power On the IRD Tune to the service in test stream</p> <p>Verify that video is displayed in original format if possible for the display.</p> <p><b>Expected result:</b> The IRD shall negotiate the display parameters according the input signal.</p>	
<b>Test result(s)</b>		
<b>Conformity</b>	<input type="checkbox"/> OK Fault <input type="checkbox"/> Major <input type="checkbox"/> Minor, define fail reason in comments	
<b>Comments</b>	If possible describe if fault can be fixed with software update: <input type="checkbox"/> YES <input type="checkbox"/> NO Describe more specific faults and/or other information	
<b>Date</b>		<b>Sign</b>

<b>Test Case</b>	<b>Task 9:6 HDMI – Manual setting for resolution</b>
<b>Section</b>	NorDig Unified8.6.2

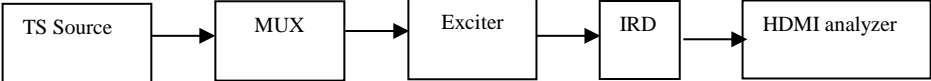
<b>Requirement</b>	By choosing a “Fixed Format” option, i.e. to manually set, preferably with a dedicated knob on the remote control, the default output format from the NorDig STB to a fixed video format. The video format options shall include 1920x1080p@50Hz, 1280x720p@50Hz and 1920x1080i@25Hz.
<b>IRD Profile(s)</b>	Basic, IRD, FE
<b>Test procedure</b>	<p><b>Purpose of test:</b> To verify that the receiver has manual setting video resolution in HDMI output.</p> <p>This test is relevant for STB only.</p> <p>For other IRDs having HDMI output interface this test is optional.</p> <p><b>Equipment:</b></p>  <pre> graph LR     TS[TS Source] --&gt; MUX[MUX]     MUX --&gt; Exciter[Exciter]     Exciter --&gt; IRD[IRD]     IRD --&gt; Analyzer[HDMI analyzer]   </pre> <p><b>Test procedure:</b></p> <ol style="list-style-type: none"> <li>1. Set the manually the display format to 1280*720p50.</li> <li>2. Verify that the video format is set.</li> <li>3. Repeat the test with 1920*1080i25 and 1920*1080p50 formats</li> <li>4. Fill in the test results.</li> </ol> <p><b>Expected result:</b></p> <p>It shall be possible to set video resolution manually in HDMI output.</p>
<b>Test result(s)</b>	
<b>Conformity</b>	<input type="checkbox"/> OK <input type="checkbox"/> Fault <input type="checkbox"/> Major <input type="checkbox"/> Minor, define fail reason in comments
<b>Comments</b>	If possible describe if fault can be fixed with software update: <input type="checkbox"/> YES <input type="checkbox"/> NO Describe more specific faults and/or other information
<b>Date</b>	<b>Sign</b>

<b>Test Case</b>	<b>Task 9:7 HDMI – Signal protection</b>
<b>Section</b>	NorDig Unified8.6.4
<b>Requirement</b>	<p>HDMI interfaces that can output content that is originated from a DVB input signal shall support the High-bandwidth Digital Content Protection (HDCP) [39].</p> <p>The received service may be flagged with a need for content protection or not (CP “ON” or “OFF”) via either the PMT-table or the CA-system or both, as specified by the relevant network/CA-operator.</p> <p>Note 1: Disabling of HDCP is optional</p>
<b>IRD Profile(s)</b>	Basic, IRD, FE
<b>Test procedure</b>	<p><b>Purpose of test:</b> To verify that the receiver is able set the status HDCP according the signal protection scheme.</p>

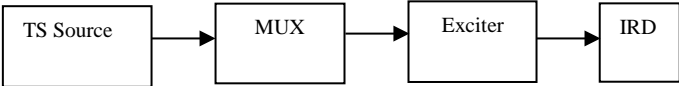

	<p>This test is mandatory if the IRD has HDMI output interface.</p> <p><b>Equipment:</b></p> <div style="text-align: center;">  <pre> graph LR     TS[TS Source] --&gt; MUX[MUX]     MUX --&gt; Exc[Exciter]     Exc --&gt; IRD[IRD]             </pre> </div> <p><b>Test procedure:</b></p> <ol style="list-style-type: none"> <li>1. Setup the equipment</li> <li>2. Set the content protection mode to one by one each mode in table below</li> <li>3. Fill in test results</li> </ol> <p><b>Expected result:</b></p> <p>It shall be possible to set the content protection mode.</p>																																																
<i>Test result(s)</i>	<table border="1" style="width: 100%; border-collapse: collapse;"> <thead> <tr> <th style="width: 5%;">Mode</th> <th style="width: 45%;">IRD actions</th> <th style="width: 15%;">CA-system</th> <th style="width: 15%;">PMT-table</th> <th style="width: 20%;">NOK or OK</th> </tr> </thead> <tbody> <tr> <td style="text-align: center;">1</td> <td>HDCP may be disabled for this service regardless of HDCP user setting (Return to HDCP-user setting when leaving this service)  Note: This requirement is optional</td> <td style="text-align: center;">HDCP Not wanted</td> <td style="text-align: center;">0x00 (HDCP Not wanted)</td> <td></td> </tr> <tr> <td style="text-align: center;">2</td> <td>HDCP shall be enabled for viewing this service (Return to HDCP-user setting when leaving this service)</td> <td style="text-align: center;">HDCP Wanted</td> <td style="text-align: center;">0x00 (HDCP Not wanted)</td> <td></td> </tr> <tr> <td style="text-align: center;">3</td> <td>Content protection is not required. HDCP may be enabled or disabled</td> <td style="text-align: center;">CP Not needed</td> <td style="text-align: center;">0x01 (Not needed)</td> <td></td> </tr> <tr> <td style="text-align: center;">4</td> <td>Content protection is required. HDCP shall be enabled for viewing this service</td> <td style="text-align: center;">CP Required</td> <td style="text-align: center;">0x01 (Not needed)</td> <td></td> </tr> <tr> <td style="text-align: center;">5</td> <td>SD service: HDCP may be enabled or disabled HD service: HDCP shall be enabled this service</td> <td style="text-align: center;">CP Not needed</td> <td style="text-align: center;">0x02 (cond' al require- ment)</td> <td></td> </tr> <tr> <td style="text-align: center;">6</td> <td>Content protection is required. HDCP shall be enabled for viewing this service</td> <td style="text-align: center;">CP Required</td> <td style="text-align: center;">0x02 (cond' al require- ment)</td> <td></td> </tr> <tr> <td style="text-align: center;">7</td> <td>Content protection is required. HDCP shall be enabled for viewing this service</td> <td style="text-align: center;">CP Not needed</td> <td style="text-align: center;">0x03 (CP required)</td> <td></td> </tr> <tr> <td style="text-align: center;">8</td> <td>Content protection is required. HDCP shall be enabled for viewing this service</td> <td style="text-align: center;">CP Required</td> <td style="text-align: center;">0x03 (CP required)</td> <td></td> </tr> </tbody> </table>				Mode	IRD actions	CA-system	PMT-table	NOK or OK	1	HDCP may be disabled for this service regardless of HDCP user setting (Return to HDCP-user setting when leaving this service)  Note: This requirement is optional	HDCP Not wanted	0x00 (HDCP Not wanted)		2	HDCP shall be enabled for viewing this service (Return to HDCP-user setting when leaving this service)	HDCP Wanted	0x00 (HDCP Not wanted)		3	Content protection is not required. HDCP may be enabled or disabled	CP Not needed	0x01 (Not needed)		4	Content protection is required. HDCP shall be enabled for viewing this service	CP Required	0x01 (Not needed)		5	SD service: HDCP may be enabled or disabled HD service: HDCP shall be enabled this service	CP Not needed	0x02 (cond' al require- ment)		6	Content protection is required. HDCP shall be enabled for viewing this service	CP Required	0x02 (cond' al require- ment)		7	Content protection is required. HDCP shall be enabled for viewing this service	CP Not needed	0x03 (CP required)		8	Content protection is required. HDCP shall be enabled for viewing this service	CP Required	0x03 (CP required)	
Mode	IRD actions	CA-system	PMT-table	NOK or OK																																													
1	HDCP may be disabled for this service regardless of HDCP user setting (Return to HDCP-user setting when leaving this service)  Note: This requirement is optional	HDCP Not wanted	0x00 (HDCP Not wanted)																																														
2	HDCP shall be enabled for viewing this service (Return to HDCP-user setting when leaving this service)	HDCP Wanted	0x00 (HDCP Not wanted)																																														
3	Content protection is not required. HDCP may be enabled or disabled	CP Not needed	0x01 (Not needed)																																														
4	Content protection is required. HDCP shall be enabled for viewing this service	CP Required	0x01 (Not needed)																																														
5	SD service: HDCP may be enabled or disabled HD service: HDCP shall be enabled this service	CP Not needed	0x02 (cond' al require- ment)																																														
6	Content protection is required. HDCP shall be enabled for viewing this service	CP Required	0x02 (cond' al require- ment)																																														
7	Content protection is required. HDCP shall be enabled for viewing this service	CP Not needed	0x03 (CP required)																																														
8	Content protection is required. HDCP shall be enabled for viewing this service	CP Required	0x03 (CP required)																																														
<i>Conformity</i>	<input type="checkbox"/> <b>OK</b> <input type="checkbox"/> <b>Fault</b> <input type="checkbox"/> <b>Major</b> <input type="checkbox"/> <b>Minor</b> , define fail reason in comments																																																
<i>Comments</i>	If possible describe if fault can be fixed with software update: <input type="checkbox"/> <b>YES</b> <input type="checkbox"/> <b>NO</b> Describe more specific faults and/or other information																																																
<i>Date</i>			<i>Sign</i>																																														

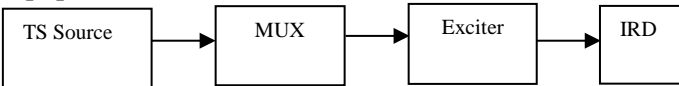
<b>Test Case</b>	<b>Task 9:8 Analogue video interface(Option)</b>	
<b>Section</b>	NorDig Unified8.6.5	
<b>Requirement</b>	<p>The NorDig STB shall provide down-converted versions of the received HDTV signals via analogue video interfaces, where the output signal is down-converted to SDTV format, see section 5.11.</p> <p>The NorDig IRD may provide analogue audio output signals via the SCART and/or the RCA connectors, as specified in sections 8.4, 8.5.1 and 8.5.2.</p>	
<b>IRD Profile(s)</b>	Basic, IRD, FE	
<b>Test procedure</b>	<p><b>Purpose of test:</b> To verify that the IRD always outputs SD (576i) on the SCART or any other analogue video output (Y, P<sub>b</sub>, P<sub>r</sub>, RF-PAL or CVBS) connector.</p> <p>This test is relevant only for IRD with analogue video output interface.</p> <p><b>Equipment:</b></p>  <pre> graph LR     TS[TS Source] --&gt; MUX[MUX]     MUX --&gt; Exciter[Exciter]     Exciter --&gt; IRD[IRD]     </pre> <p>The TS shall contain a service which has a video component that</p> <ul style="list-style-type: none"> <li>• Change between 1280 x 720p@50Hz and 1920 x 1080i@25Hz video resolution</li> </ul> <p><b>Test procedure:</b></p> <ol style="list-style-type: none"> <li>1. Set up the test environment according to above.</li> <li>2. Play out the transport stream with alternating video resolutions 1280 x 720p@50Hz and 1920 x 1080i@25Hz</li> <li>3. Make a channel search on the IRD</li> <li>4. Verify that the SCART or any other analogue video output has always SD (576i) regardless of HDMI setting and resolution.</li> <li>5. Verify that down-converted 1:1 pixel aspect ratio resolutions are displayed as 16:9 letterbox on 4:3 displays.</li> </ol> <p><b>Expected result:</b> That the IRD only outputs SD (576i) on SCART any other analogue video output (i.e. not higher than 576i).</p>	
<b>Test result(s)</b>		
<b>Conformity</b>	<input type="checkbox"/> <b>OK Fault</b> <input type="checkbox"/> Major <input type="checkbox"/> Minor, define fail reason in comments	
<b>Comments</b>	<p>If possible describe if fault can be fixed with software update: <input type="checkbox"/> <b>YES</b> <input type="checkbox"/> <b>NO</b></p> <p>Describe more specific faults and/or other information</p>	
<b>Date</b>		<b>Sign</b>

<b>Test Case</b>	<b>Task 9:9 Remote Control Function Keys</b>	
<b>Section</b>	NorDig 8.7.2	



<b>Requirement</b>	<p>The remote control for the NorDig IRD shall include the following functions (the labelling names that are used in Figure 8.1 are shown below within square brackets for each function), associated with input events. An input event may be associated with a physical key or a logical (e.g. on-screen) key, where the “logical key” is associated with the same function as specified for the corresponding physical key.</p> <p>The NorDig IRD remote control shall include 10 digit keys, labeled 0-9</p> <p>The NorDig IRD’s remote control shall include the following keys for digital TV functions:</p> <ul style="list-style-type: none"> <li>o [←, ↑, →, ↓] – A navigation or pointing system for navigation on the OSD</li> <li>o OK [OK] – a function that selects or confirms current choice or statement</li> <li>o Multifunctional keys [•, •, •, •] – four colour-coded keys for non-dedicated functions. The colours shall be red, green, yellow and blue</li> <li>o Text [Text] – This function displays the teletext as defined in section 7.1 or a Digital Super Teletext if present.</li> </ul>
<b>IRD Profile(s)</b>	Basic, IRD, FE
<b>Test procedure</b>	<p><b>Test procedure:</b></p> <p>Check the manufacturer technical specification / compliance list or verify the remote control functions.</p> <p><b>Expected result:</b></p> <p>The minimum hardware requirement is fulfilled.</p>
<b>Test result(s)</b>	
<b>Conformity</b>	<input type="checkbox"/> OK Fault <input type="checkbox"/> Major <input type="checkbox"/> Minor, define fail reason in comments
<b>Comments</b>	<p>If possible describe if fault can be fixed with software update: <input type="checkbox"/> YES <input type="checkbox"/> NO</p> <p>Describe more specific faults and/or other information</p>
<b>Date</b>	<b>Sign</b>

<b>Test Case</b>	<b>Task 9:10 Remote Control Function Keys for PVR</b>
<b>Section</b>	NorDig 8.7.2.4
<b>Requirement</b>	<p>The NorDig PVR IRD's remote control shall include the following keys for PVR functionality:</p> <ul style="list-style-type: none"> <li>o List of recordings [PVR List] – opens a screen with list of recordings (can be both history and booked).</li> <li>o OTR [OTR] – One-Touch-Recording</li> <li>o Record [Rec] – Start manual recording / start recording of present event.</li> <li>o Timeshift [t.shift] – "pause" live TV (timeshift)</li> <li>o Pause [Pause] – pause Playback of recording.</li> <li>o Play [Play] – start playing timeshift TV / start playback of recording.</li> <li>o Stop [Stop] – stop recording / stop timeshift / stop playback.</li> <li>o Fast Forward [F.fwd] – fast forward of the timeshift or recording (with different speeds).</li> <li>o Fast Rewind [F.rwd] – fast rewind of the timeshift or recording (with different speeds).</li> </ul>
<b>IRD Profile(s)</b>	Basic, PVR, IRD, FE
<b>Test procedure</b>	<p><b>Test procedure:</b></p> <p>Check the manufacturer technical specification / compliance list or verify the remote</p>



	control functions.
	<b>Expected result:</b> The minimum hardware requirement is fulfilled.
<b>Test result(s)</b>	
<b>Conformity</b>	<input type="checkbox"/> <b>OK Fault</b> <input type="checkbox"/> Major <input type="checkbox"/> Minor, define fail reason in comments
<b>Comments</b>	If possible describe if fault can be fixed with software update: <input type="checkbox"/> <b>YES</b> <input type="checkbox"/> <b>NO</b> Describe more specific faults and/or other information
<b>Date</b>	<b>Sign</b>

<b>Test Case</b>	<b>Task 9:11 Remote Control Key event mapping for NorDig Hybrid</b>
<b>Section</b>	NorDig 8.7.2.6
<b>Requirement</b>	The NorDig Hybrid IRD shall generate (HbbTV) events according to Table 8.3 when a key is pressed on the NorDig IRD remote control.
<b>IRD Profile(s)</b>	Hybrid, PVR, IRD, FE
<b>Test procedure</b>	<b>Test procedure:</b> Check the manufacturer technical specification / compliance list or verify the remote control functions.  <b>Expected result:</b> The minimum hardware requirement is fulfilled.
<b>Test result(s)</b>	
<b>Conformity</b>	<input type="checkbox"/> <b>OK Fault</b> <input type="checkbox"/> Major <input type="checkbox"/> Minor, define fail reason in comments
<b>Comments</b>	If possible describe if fault can be fixed with software update: <input type="checkbox"/> <b>YES</b> <input type="checkbox"/> <b>NO</b> Describe more specific faults and/or other information
<b>Date</b>	<b>Sign</b>

## 2.10 Task 10: Interfaces for Conditional Access

<b>Test Case</b>	<b>Task 10:1 Use of Common Interface</b>	
<b>Section</b>	NorDig Unified 9.2	
<b>Requirement</b>	<p>The Common Interface can be used for conditional access and other purposes. A conditional access (CA) module may be connected to the Common Interface of the NorDig IRD in order to provide access control of the incoming services.</p> <p>The Common Interface may be used with CA-modules that comply with the Common Interface Plus specification, see refCI Plus specification; such modules are referred to as CIP-CAM.</p> <p>The Common Interface may be also be used with CA-modules that comply with the DVB Common Interface specification, see EN 50221; such modules are referred to as DVB-CAM.</p> <p>Each CI-slot of the NorDig IRD shall (1&amp;2) be in compliance with the Common Interface Plus specification. Each CI-slot shall support both CIP-CAMs and DVB-CAMs in accordance with with the interoperability matrix that is specified in the CI Plus specification, table 4.1.</p>	
<b>IRD Profile(s)</b>	Basic, IRD, FE	
<b>Test procedure</b>	<p>The Test procedure shall (provisionally) be based on existing interface test specifications for at least the most common CAMs supporting both DVB-CAM and CIP-CAM.</p> <p>The IRD manufacturer shall describe the used test procedure.</p>	
<b>Test result(s)</b>	The test results shall show that the IRD is fully compatible with CAM, when the CAM is equipped for at least one of the CA-systems used in the Nordic area.	
<b>Conformity</b>	<input type="checkbox"/> OK Fault <input type="checkbox"/> Major <input type="checkbox"/> Minor, define fail reason in comments	
<b>Comments</b>	<p>If possible describe if fault can be fixed with software update: <input type="checkbox"/> YES <input type="checkbox"/> NO</p> <p>Describe more specific faults and/or other information</p>	
<b>Date</b>		<b>Sign</b>

<b>Test Case</b>	<b>Task 10:2 Smart Card Interface</b>	
<b>Section</b>	NorDig Unified 9.3.2	
<b>Requirement</b>	<p>The NorDig IRD shall include at least one (1) embedded smart card reader for use with conditional access and/or other applications.</p> <p>The smart card interface shall comply with ISO/IEC 7816 Part 1-3 [60]. The NorDig IRD does not need to support synchronous cards.</p>	
<b>IRD Profile(s)</b>	Basic, IRD, FE	



NorDig

<b>Test procedure</b>	<b>Purpose of test:</b> Verify functionality of smart card interface.  This test is mandatory depending of the network operator or operator requirement.  <b>Equipment:</b> Test bed providing transport streams with CA-scrambled services. IRD under test.  <b>Test procedure:</b> Select a CA-scrambled service and observe decoded picture/sound.
<b>Test result(s)</b>	
<b>Conformity</b>	<input type="checkbox"/> <b>OK</b> <input type="checkbox"/> <b>Fault</b> <input type="checkbox"/> Major <input type="checkbox"/> Minor, define fail reason in comments
<b>Comments</b>	If possible describe if fault can be fixed with software update: <input type="checkbox"/> <b>YES</b> <input type="checkbox"/> <b>NO</b> Describe more specific faults and/or other information
<b>Date</b>	<b>Sign</b>

## 2.11 Task 11: The System Software Update

### 2.11.1 Test equipment summary

To configure the minimum test setup described in these test procedures, the test setup seen in Figure 3. Generic test setup for SSU / CI+ CAM test procedure can be used.

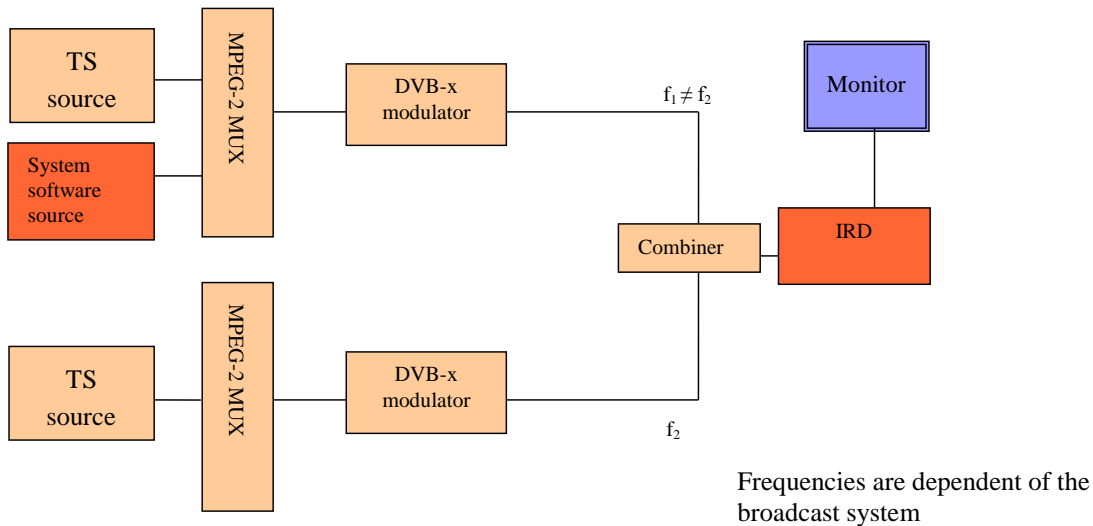

**Figure 3. Generic test setup for SSU / CI+ CAM test procedures**

Note! The needed equipment may vary depending on the used system and can be purchased from many vendors even in a compact all-in-one unit. However, most of the tests can be done using one general test setup.

The SSU / CI+ CAM service is carried within a transport stream. The TS must contain correct type of signaling information in order for the receiver to detect correct SSU / CI+ CAM service. The following sections describe minimum signaling information.

#### The NIT must contain:

- Linkage\_descriptor 0x4A to DVB SSU service using linkage\_type 0x09.

Example for linkage\_descriptor for IRD system download located at Tsid/Onid 0x0456/0x22F1.

Descriptor_tag	0x4A
Transport_stream_id	0x0456
Original_network_id	0x22F1
Service_id	0x1194
Linkage_type	0x09
OUI *)	
selector_bytes	
private_data_byte **)	

\*) DVB OUI or manufacture specific OUI

\*\*) The private\_data\_byte shall be used as specified in the DVB Data Download Specification; Part 1: Simple Profile. (ETSI TS 102 006 v1.3.1 )

**The PMT must contain:**

(The descriptor shall be placed in the component loop of the PSI PMT table.)

- Data\_broadcast\_id\_descriptor

Descriptor_tag	0x66
Data_broadcast_id	0x000A
Id_sector_bytes *)	
OUI **)	
update_type ***)	
update_versioning_flag	
update_version	
selector_bytes	
private_data_bytes	

\*) The id\_sector\_bytes shall be used as specified in the DVB Data Download Specification (ETSI TS 102 006)

\*\*) The OUI value in the PMT shall match the OUI value in the NIT linkage to SSU descriptor.

\*\*\*) Update\_type, use value below specified for simple or enhanced profiles

proprietary update solution (not allowed)	0x0
standard update carousel (i.e. without notification table) via broadcast	0x1
system software update carousel with notification table (UNT) both available via broadcast	0x2
system software update signalled via broadcast UNT, update available from the return channel	0x03
system software update signalled via broadcast UNT, update available from the Internet	0x04
Reserved for future use	0x5 – 0xFF

**The UNT must contain:**

Signalling of UNT is relevant in case of the data\_broadcast\_id\_descriptor parameter update\_type is set to 0x02 in PMT.

The parameters for different descriptors in UNT are specified below:

Descriptor_tag	0x4B
table_id	0x01
OUI <sup>1)</sup>	
processing_order <sup>2)</sup>	
common_descriptor_loop <sup>3)</sup>	
target_descriptor_loop <sup>4)</sup>	
operational_descriptor_loop <sup>5)</sup>	

1) The OUI value in the PMT shall match the OUI value in the NIT linkage to SSU descriptor.

2) Depending of the SSU OTA mechanism

3) Common\_descriptor\_loop carries information which is intended for descriptors which apply to all platform/target devices listed in target\_descriptor\_loop and operational\_descriptor\_loop

4) Target\_descriptor\_loop can contain descriptor

- target\_serial\_number\_descriptor

5) operational\_descriptor\_loop can contain descriptors

- scheduling\_descriptor

Example for scheduling\_descriptor

descriptor_tag	0x01
start_date_time	



end_date_time	
final_availability	0
periodicity_flag	
period_unit	
duration_unit	
estimated_cycle_time_unit	
period	
duration	
estimated_cycle_time	

- update\_descriptor
- ssu\_location\_descriptor
- message\_descriptor
- ssu\_subgroup\_association\_descriptor
- private\_data\_specifier\_descriptor

See more details regarding settings in DVB Data Download Specification (ETSI TS 102 006)

NorDig T2-IRD SSU OTA in DVB-T2 system

- The SSU stream is broadcasted with parameters settings PLP\_ID = 1, T2\_System\_Id = 1 and Cell\_Id = 1 in a single PLP mode.

### 2.11.2 Test cases

<b>Test Case</b>	<b>Task 11:1 IRD System software update using DVB SSU simple profile</b>
<b>Section</b>	NorDig Unified 10.1, 10.3 and 10.6
<b>Requirement</b>	<p>The NorDig IRD shall provide a software download mechanism that enables download of software modules, to add a new software module or replace an existing software module.</p> <p>The actual upgrade of NorDig IRD software shall be initiated by the user (by update user preference setting and/or by user interaction). The user shall be able to disable any automatic update in the user preference settings for SSU.</p> <p>In cases where the user is prompted to confirm an update, the user shall be able to confirm or to abort/postpone the update.</p> <p>The user should be able to control when the installation will be performed, like proceed immediately or perform update in standby. The user shall be able to choose the update approach for the IRD (tested in Task 11:4)</p> <p>Any notification to the user (pop-up message) related to SSU shall be displayed in the same language as the language setting of the IRD.</p> <p>If the system software update does not allow the normal utilization of the</p>

	<p>NorDig IRD, the user shall be warned by some means. For example, by displaying information if the display is not available,(tested in Task 11.4).</p> <p>The progress of the download shall be displayed by the NorDig IRD. If the user chooses to abort the system software upgrade, the NorDig IRD shall remind the user during next restart or shutdown of the IRD to upgrade the receiver if the new software is available over the broadcast channel.</p> <p>The IRD shall inform the user whether there is an IRD update or CIP-CAM update.</p> <p>The IRD manufacturer shall ensure that download of non-certified system-software is prevented. If the NorDig IRD System software is corrupt, the IRD manufacturer shall provide a backup mechanism, either on local storage or via download, which can make the IRD operational again.</p> <p>The NorDig IRD shall be implemented with a protection mechanism for the existing system software. It shall ensure that the existing software will not be corrupted in case the System Software Update (SSU) is interrupted before the new system software is fully downloaded.</p> <p>The NorDig IRD shall be provided with a mechanism ensuring that only newer software versions than the existing System Software are accepted.</p> <p>The IRD manufacturer shall ensure that there are not any compatibility issues if different System Software versions are broadcast via different operators.</p> <p>The NorDig IRD shall support the SSU simple profile using the signaling in NIT, BAT and PMT, in accordance with the DVB-SSU specification. The Linkage descriptor in the NIT table, for linking to the SSU service is defined in section 12.2.6 (The UNT is not used for this profile, see chapter 5 of ref ETSI TS 102 006 ).</p>
<b>IRD Profile(s)</b>	Basic, IRD, FE
<b>Test procedure</b>	<p><b>Purpose of test:</b> To verify the IRD system software update process in broadcast channel using DVB SSU simple profile.</p> <p>The SSU end user functionality is not tested in this case. It is tested in Task 11:4 SSU end user functionality.</p> <p>This test is convenient to do parallel with Task 11:4 SSU end user functionality.</p> <p><b>Equipment:</b> Test setup described in 2.11.1 Test equipment summary</p> <p>Software to upgrade</p> <p>2 pcs IRDs with older software than the version to upgrade or older software to downgrade the IRD under testing.</p>

Selection of two different ONID for different networks corresponding country1 and country2 in the test procedure.

**Test procedure:**

1. Connect and start up the instruments.
2. Configure three outgoing download streams from the system software source. The system software PID, PMT PID and SID may not conflict with each other.
3. Configure the multiplexer to transmit three outgoing system software download streams within TS on the frequency f1. The system software PID, PMT PID and SID may not conflict with each other. (Simulates three system software streams.)
4. Configure linkage\_descriptor for the two system software download streams not to be suitable for the receiver under test. The linkage\_descriptor parameters for the third download stream shall be suitable for the receiver under test. The third system software download stream shall be the last in order.
5. Fill in the test results which parameters are unmatching with the receiver under test.
6. For the frequency f2 configure linkage\_descriptor to refer to the frequency f1 with suitable parameters for the over-the-air download. (Simulates frequency change).
7. Do a channel search and check that all the services are possible to receive.
8. Tune the receiver to a service on the frequency f1.
9. Fill in the test results if the IRD has a setting for automatic search and it is set to "auto search".
10. Initiate the download.
11. Verify that the software is being updated.
12. Fill in the test protocol.
13. Download older software to the receiver in use or use other receiver.
14. Tune the receiver to a service on the frequency f2.
15. Initiate the download again.
16. Verify that the software is being updated.
17. Fill in the test protocol.
18. Downgrade older software to the receiver in use or use another receiver with older software as broadcasted software version.
19. Initiate the download again.
20. Plug out the electric cable to corrupt the downloading of the system software.
21. Plug in the electric cable.
22. Verify that the receiver is still usable.
23. Fill in the test protocol. Fill in extended information in the comments section if the receiver ends up in an error state. Error messages etc.
24. Initiate the download again.
25. Plug out the antenna cable. (Simulates RF disturbances).
26. Plug in the antenna cable.
27. Fill in the test protocol. Fill in extended information in the comments section if the receiver ends up in an error state. Error messages etc.
28. Downgrade the IRD to the original software, or use another sample of the IRD with the original software if available.
29. Verify which ONID values correspond country1 and country2 settings in IRD.
30. Make sure that the IRDs country setting is equal to country2.
31. Configure the TS from f1 carrying the SSU service so that the ONID is equal to country1.
32. Configure the TS from f2 so that the ONID is equal to country2.
33. Fill in the test protocol which ONID values are broadcasted in TS in f1 (country1) and f2 (country2).
34. Fill in the test protocol which country settings are selected in the IRD.

	<p>35. Control that the IRD will not download and install the SSU. 36. Fill in the test protocol.</p> <p><b>Expected result:</b> Receiver performs a software update from DVB SSU simple profile OTA broadcast available stream.</p>																																		
<i>Test result(s)</i>	<table border="1" style="width: 100%; border-collapse: collapse;"> <thead> <tr> <th style="width: 50%;">Unmatched SSU stream number</th> <th style="width: 50%;">Unmatched parameter name</th> </tr> </thead> <tbody> <tr> <td style="text-align: center;">#1</td> <td></td> </tr> <tr> <td style="text-align: center;">#2</td> <td></td> </tr> </tbody> </table> <table border="1" style="width: 100%; border-collapse: collapse;"> <thead> <tr> <th style="width: 50%;"></th> <th style="width: 50%;">ONID value</th> </tr> </thead> <tbody> <tr> <td>ONID value in TS in f1 (country1)</td> <td></td> </tr> <tr> <td>ONID value in TS in f2 (country2)</td> <td></td> </tr> </tbody> </table> <table border="1" style="width: 100%; border-collapse: collapse;"> <thead> <tr> <th style="width: 15%;">Test points</th> <th style="width: 65%;"></th> <th style="width: 20%;">OK or NOK</th> </tr> </thead> <tbody> <tr> <td>9</td> <td>Does IRD have a setting for automatic SSU search set by default to “auto search” ?</td> <td></td> </tr> <tr> <td>10- 12</td> <td>The correct system software on the frequency f1 is upgraded.</td> <td></td> </tr> <tr> <td>13 – 17</td> <td>The correct system software, when initiated on frequency f2, is upgraded.</td> <td></td> </tr> <tr> <td>18 – 23</td> <td>Receiver starts after electric break using old (working) software.</td> <td></td> </tr> <tr> <td>24 – 27</td> <td>The receiver clarifies the RF signal reception disturbances under OTA download. It has current software.</td> <td></td> </tr> <tr> <td>28 – 36</td> <td>The Receiver does not download or install the SSU from other ONIDs than the ONID that matches the country setting in the IRD.</td> <td></td> </tr> </tbody> </table>		Unmatched SSU stream number	Unmatched parameter name	#1		#2			ONID value	ONID value in TS in f1 (country1)		ONID value in TS in f2 (country2)		Test points		OK or NOK	9	Does IRD have a setting for automatic SSU search set by default to “auto search” ?		10- 12	The correct system software on the frequency f1 is upgraded.		13 – 17	The correct system software, when initiated on frequency f2, is upgraded.		18 – 23	Receiver starts after electric break using old (working) software.		24 – 27	The receiver clarifies the RF signal reception disturbances under OTA download. It has current software.		28 – 36	The Receiver does not download or install the SSU from other ONIDs than the ONID that matches the country setting in the IRD.	
Unmatched SSU stream number	Unmatched parameter name																																		
#1																																			
#2																																			
	ONID value																																		
ONID value in TS in f1 (country1)																																			
ONID value in TS in f2 (country2)																																			
Test points		OK or NOK																																	
9	Does IRD have a setting for automatic SSU search set by default to “auto search” ?																																		
10- 12	The correct system software on the frequency f1 is upgraded.																																		
13 – 17	The correct system software, when initiated on frequency f2, is upgraded.																																		
18 – 23	Receiver starts after electric break using old (working) software.																																		
24 – 27	The receiver clarifies the RF signal reception disturbances under OTA download. It has current software.																																		
28 – 36	The Receiver does not download or install the SSU from other ONIDs than the ONID that matches the country setting in the IRD.																																		
<i>Conformity</i>	<input type="checkbox"/> <b>OK</b> <input type="checkbox"/> <b>Fault</b> <input type="checkbox"/> Major <input type="checkbox"/> Minor, define fail reason in comments																																		
<i>Comments</i>	If possible describe if fault can be fixed with software update: <input type="checkbox"/> <b>YES</b> <input type="checkbox"/> <b>NO</b> Describe more specific faults and/or other information																																		
<i>Date</i>		<i>Sign</i>																																	

<i>Test Case</i>	<b>Task 11:2 IRD System software update using DVB SSU enhanced profile - scheduling</b>
<i>Section</i>	NorDig Unified 10.1, 10.2, 10.3, 10.5 and 10.6
<i>Requirement</i>	The NorDig IRD shall support the SSU UNT Enhanced profile using the signaling in NIT, BAT, PMT, and UNT, in accordance with the DVB-SSU specification. The Linkage descriptor in the NIT table, for linking to the SSU service is defined in section 12.2.6 [1]. The descriptors of the UNT Enhanced profile shall be as specified in Section 12.7 [1].
<i>IRD Profile(s)</i>	Basic, IRD, FE

*Test procedure*

**Purpose of test:**

To verify the IRD system software update process in broadcast channel using DVB SSU enhanced profile.

The SSU end user functionality is not tested in this case. It is tested in Task 11:4 SSU end user functionality.

This test is convenient to do parallel with Task 11:4 SSU end user functionality.

**Equipment:**

Test setup described in 2.11.1 Test equipment summary

Software to upgrade suitable for SSU enhanced profile and for the IRD under test, scheduled in the future, with more than one schedule\_descriptor in UNT.

2 pcs IRDs with older software than the version to upgrade or older software to downgrade the IRD under testing.

**Test procedure:**

Refer to Task 11:1 but use DVB SSU enhanced download stream instead.

1. Connect and start up the instruments.
2. Configure three outgoing download streams from the system software source. The system software PID, PMT PID and SID may not conflict with each other.
3. Configure the multiplexer to transmit three outgoing system software download streams within TS on the frequency f1. (Simulates three system software streams.)
4. Configure linkage\_descriptor for the two system software download streams not to be suitable for the receiver under test. The linkage\_descriptor parameters for the third download stream shall be suitable for the receiver under test. The third system software download stream shall be the last in order.
5. Fill in the test results which parameters are unmatching with the receiver under test.
6. Configure UNT inclusive scheduling\_descriptor by creating schedule with three scheduling descriptors, one in the past and two in the future for the system download streams.
7. For the frequency f2 configure linkage\_descriptor to refer to the frequency f1 with suitable parameters for the over-the-air download. (Simulates frequency change).
8. Fill in the test protocol if the IRD support automatic search and it is set to "automatic search" by default.
9. Turn off the IRD and wait until IRD is standby.
10. Turn on the IRD from standby.
11. A message shall be displayed telling that a new software is available at the time specified in the scheduling\_descriptor. The IRD shall find the nearest available scheduled time.
12. Verify that both "OK to download" and "EXIT to abort" options works by verifying that download occurs at scheduled time and that no download occur when user selects EXIT.
13. Verify that IRD doesn't upgrade software at specified time and date.
14. Fill in the test protocol.
15. Turn off the IRD and wait until IRD is standby.
16. Turn on the IRD from standby.
17. A message shall be displayed telling that a new software is available at the time

	<p>specified in the scheduling_descriptor. The IRD shall find the nearest available scheduled time.</p> <ol style="list-style-type: none"> <li>18. Verify that both “OK to download ” and “EXIT to abort” options works by verifying that download occurs at scheduled time and that download occurs when user chooses “OK to download”.</li> <li>19. Verify that IRD is upgraded.</li> <li>20. Reset the IRD to its original sw.</li> <li>21. Enhanced profile with software for the IRD under test, scheduled active now, with more than one schedule_descriptor in UNT.</li> <li>22. Initiate a manual download from the menu.</li> <li>23. A message shall be displayed telling that a new software is available right now.</li> <li>24. Verify that both OK and EXIT works.</li> <li>25. Reset the IRD</li> <li>26. Perform 21,23,24 but initiate the download via a background/standby search.</li> <li>27. Fill in the test test results.</li> </ol> <p><b>Expected result:</b></p> <p>Receiver performs a system software update from DVB SSU enhanced profile OTA broadcast for future available stream.</p>																																	
<i>Test result(s)</i>	<table border="1" style="width: 100%;"> <thead> <tr> <th style="width: 50%;">Unmatched SSU stream number</th> <th style="width: 50%;">Unmatched parameter name</th> </tr> </thead> <tbody> <tr> <td style="text-align: center;">#1</td> <td></td> </tr> <tr> <td style="text-align: center;">#2</td> <td></td> </tr> </tbody> </table> <table border="1" style="width: 100%;"> <thead> <tr> <th style="width: 50%;"></th> <th style="width: 50%;">ONID value</th> </tr> </thead> <tbody> <tr> <td>ONID value in TS in f1 (country1)</td> <td></td> </tr> <tr> <td>ONID value in TS in f2 (country2)</td> <td></td> </tr> </tbody> </table> <table border="1" style="width: 100%;"> <thead> <tr> <th style="width: 20%;">Test points</th> <th style="width: 60%;"></th> <th style="width: 20%;">OK or NOK</th> </tr> </thead> <tbody> <tr> <td>8</td> <td>Does the IRD have a setting for automatic SSU search and it is set to “automatic search” by default?</td> <td></td> </tr> <tr> <td>9-14</td> <td>Does the IRD display a pop-up message telling the closest time and date for the available OTA ?</td> <td></td> </tr> <tr> <td>9-14</td> <td>Does the pop-up message have selection “OK to download” and “EXIT to abort” ?</td> <td></td> </tr> <tr> <td>9-14</td> <td>Selecting EXIT doesn’t upgrade the receiver at specified time and date.</td> <td></td> </tr> <tr> <td>15-20</td> <td>Does the IRD upgrade the future available software at available time and date when turned off and turned on ?</td> <td></td> </tr> <tr> <td>21-26</td> <td>Does the IRD upgrade when the new sw is available right now when searching, From menu and from standby</td> <td></td> </tr> </tbody> </table>	Unmatched SSU stream number	Unmatched parameter name	#1		#2			ONID value	ONID value in TS in f1 (country1)		ONID value in TS in f2 (country2)		Test points		OK or NOK	8	Does the IRD have a setting for automatic SSU search and it is set to “automatic search” by default?		9-14	Does the IRD display a pop-up message telling the closest time and date for the available OTA ?		9-14	Does the pop-up message have selection “OK to download” and “EXIT to abort” ?		9-14	Selecting EXIT doesn’t upgrade the receiver at specified time and date.		15-20	Does the IRD upgrade the future available software at available time and date when turned off and turned on ?		21-26	Does the IRD upgrade when the new sw is available right now when searching, From menu and from standby	
Unmatched SSU stream number	Unmatched parameter name																																	
#1																																		
#2																																		
	ONID value																																	
ONID value in TS in f1 (country1)																																		
ONID value in TS in f2 (country2)																																		
Test points		OK or NOK																																
8	Does the IRD have a setting for automatic SSU search and it is set to “automatic search” by default?																																	
9-14	Does the IRD display a pop-up message telling the closest time and date for the available OTA ?																																	
9-14	Does the pop-up message have selection “OK to download” and “EXIT to abort” ?																																	
9-14	Selecting EXIT doesn’t upgrade the receiver at specified time and date.																																	
15-20	Does the IRD upgrade the future available software at available time and date when turned off and turned on ?																																	
21-26	Does the IRD upgrade when the new sw is available right now when searching, From menu and from standby																																	
<i>Conformity</i>	<input type="checkbox"/> <b>OK Fault</b> <input type="checkbox"/> Major <input type="checkbox"/> Minor, define fail reason in comments																																	
<i>Comments</i>	<p>If possible describe if fault can be fixed with software update: <input type="checkbox"/> <b>YES</b> <input type="checkbox"/> <b>NO</b></p> <p>Describe more specific faults and/or other information</p>																																	

<i>Date</i>		<i>Sign</i>	

<b>Test Case</b>	<b>Task 11:3 IRD System software update using DVB SSU Notifications update type 0x4</b>
<b>Section</b>	NorDig Unified 10.1, 10.2, 10.3, 10.5, 10.6 and 12.7
<b>Requirement</b>	The NorDig IRD shall support the SSU notifications update type 0x4 using UNT in accordance with the DVB-SSU specification. Linkage descriptor in the NIT table, for linking to the SSU service is defined in section 12.2.6 [1]. The descriptors of the SSU UNT shall be as specified in Section 12.7 [1].
<b>IRD Profile(s)</b>	Basic, IRD, FE
<b>Test procedure</b>	<p><b>Purpose of test:</b> To verify the IRD system software update process in broadcast channel using DVB SSU Notifications. A typical use case for SSU Notification is to reach all non-connected connectable IRDs via broadcast channel with information that new SSU software is available but the new SSU software size is too large to be distributed via broadcast channel and/or requires a higher bandwidth over broadcast channel than is available. Manufacturers are recommended to:</p> <ul style="list-style-type: none"> <li>- Pre-store SSU messages in their IRDs and messages should be in all available languages that the IRD supports,</li> <li>- Mainly using the message_index (in the enhanced_message_descriptor, see 12.7.10) to reference which pre-stored message to be displayed for the user,</li> <li>- Minimise the broadcast text (in the enhanced_message_descriptor and/or message descriptor, see 12.7.10).</li> </ul> <p><b>Equipment:</b> Test setup described in 2.11.1 Test equipment summary</p> <p>Software/configuration information to enable the SSU Notification process in the IRD.</p> <p><b>Test procedure:</b></p> <ol style="list-style-type: none"> <li>1. Configure three outgoing download streams from the system software source. The system software PID, PMT PID and SID may not conflict with each other.</li> <li>2. Configure the multiplexer to transmit three outgoing system software download streams within TS on the frequency f1. The system software PID, PMT PID and SID may not conflict with each other. (Simulates three system software streams.)</li> <li>3. Configure linkage_descriptor for the two system software download streams not to be suitable for the receiver under test. The linkage_descriptor parameters for the third download stream shall be suitable for the receiver under test. The third system software download stream shall be the last in order.</li> <li>4. For the frequency f2 configure linkage_descriptor to refer to the frequency f1 with suitable parameters for the over-the-air download. (Simulates frequency change).</li> <li>5. Tune the receiver to a service on the frequency f1.</li> <li>6. Perform a manual software update search.</li> <li>7. Verify that a notification is presented</li> <li>8. Reset the IRD to its factory default settings.</li> <li>9. Repeat step 1-5.</li> <li>10. Perform an automatic search from standby.</li> <li>11. Turn on the IRD from standby.</li> <li>12. Verify that a notification is presented</li> <li>13. Reset the IRD to its factory default settings.</li> </ol>

	<ol style="list-style-type: none"> <li>14. Tune the receiver to a service on the frequency f2.</li> <li>15. Perform a manual software update search.</li> <li>16. Verify that a notification is presented</li> <li>17. Reset the IRD to its factory default settings.</li> <li>18. Repeat step 1-5.</li> <li>19. Perform an automatic search from standby.</li> <li>20. Turn on the IRD from standby.</li> <li>21. Verify that a notification is presented</li> <li>22. Fill in the test results.</li> </ol> <p><b>Expected result:</b> The IRD performs an SSU Notification update.</p>																																																											
<i>Test result(s)</i>	<table border="1" style="width: 100%; border-collapse: collapse;"> <thead> <tr> <th style="width: 50%;">Unmatched SSU stream number</th> <th colspan="4">Unmatched parameter name</th> </tr> </thead> <tbody> <tr> <td style="text-align: center;">#1</td> <td colspan="4"></td> </tr> <tr> <td style="text-align: center;">#2</td> <td colspan="4"></td> </tr> </tbody> </table> <table border="1" style="width: 100%; border-collapse: collapse;"> <thead> <tr> <th style="width: 50%;"></th> <th colspan="4">ONID value</th> </tr> </thead> <tbody> <tr> <td>ONID value in TS in f1 (country1)</td> <td colspan="4"></td> </tr> <tr> <td>ONID value in TS in f2 (country2)</td> <td colspan="4"></td> </tr> </tbody> </table> <table border="1" style="width: 100%; border-collapse: collapse;"> <thead> <tr> <th style="width: 50%;"></th> <th style="width: 12.5%;">OK or NOK Test points 6-7</th> <th style="width: 12.5%;">OK or NOK Test points 10-12</th> <th style="width: 12.5%;">OK or NOK Test points 15-16</th> <th style="width: 12.5%;">OK or NOK Test points 19-21</th> </tr> </thead> <tbody> <tr> <td>Verify that any Notification to the user (pop-up message) related to SSU shall be displayed in the same language as the language setting of the IRD.</td> <td></td> <td></td> <td></td> <td></td> </tr> <tr> <td>Verify the Notification informs the user about where the new software is available(internet adress) and how to proceed with the update process</td> <td></td> <td></td> <td></td> <td></td> </tr> <tr> <td>Verify the user have a choice to postpone/abort/reject the system software update Notification.</td> <td></td> <td></td> <td></td> <td></td> </tr> <tr> <td>If the user didn't choose to abort/ reject the notification or if the SW in the IRD was upgraded to the latest version, verify that the user is reminded with the notification after restart of the IRD</td> <td></td> <td></td> <td></td> <td></td> </tr> </tbody> </table>					Unmatched SSU stream number	Unmatched parameter name				#1					#2						ONID value				ONID value in TS in f1 (country1)					ONID value in TS in f2 (country2)						OK or NOK Test points 6-7	OK or NOK Test points 10-12	OK or NOK Test points 15-16	OK or NOK Test points 19-21	Verify that any Notification to the user (pop-up message) related to SSU shall be displayed in the same language as the language setting of the IRD.					Verify the Notification informs the user about where the new software is available(internet adress) and how to proceed with the update process					Verify the user have a choice to postpone/abort/reject the system software update Notification.					If the user didn't choose to abort/ reject the notification or if the SW in the IRD was upgraded to the latest version, verify that the user is reminded with the notification after restart of the IRD				
Unmatched SSU stream number	Unmatched parameter name																																																											
#1																																																												
#2																																																												
	ONID value																																																											
ONID value in TS in f1 (country1)																																																												
ONID value in TS in f2 (country2)																																																												
	OK or NOK Test points 6-7	OK or NOK Test points 10-12	OK or NOK Test points 15-16	OK or NOK Test points 19-21																																																								
Verify that any Notification to the user (pop-up message) related to SSU shall be displayed in the same language as the language setting of the IRD.																																																												
Verify the Notification informs the user about where the new software is available(internet adress) and how to proceed with the update process																																																												
Verify the user have a choice to postpone/abort/reject the system software update Notification.																																																												
If the user didn't choose to abort/ reject the notification or if the SW in the IRD was upgraded to the latest version, verify that the user is reminded with the notification after restart of the IRD																																																												
<i>Conformity</i>	<input type="checkbox"/> <b>OK Fault</b> <input type="checkbox"/> Major <input type="checkbox"/> Minor, define fail reason in comments																																																											
<i>Comments</i>	If possible describe if fault can be fixed with software update: <input type="checkbox"/> <b>YES</b> <input type="checkbox"/> <b>NO</b> Describe more specific faults and/or other information																																																											
<i>Date</i>			<i>Sign</i>																																																									



<b>Test Case</b>	<b>Task 11:4 SSU end user functionality</b>
<b>Section</b>	NorDig Unified 10.1, 10.2, 10.5, 16.4
<b>Requirement</b>	<p>Any (pop-up) messaging to the user related to SSU shall be displayed in the same language as the language setting of the IRD.</p> <p>If the system software update does not allow the normal utilization of the NorDig IRD, the user shall be warned by some means. For example, by displaying information if the display is not available according to NorDig unified 2.6 sec 10.1.3.</p> <p>If the user selects to abort/postpone an available update or by other ways cancel an available update, the NorDig IRD shall remind the user.</p> <p>The user shall be able to choose the update approach for the IRD and the user shall be able to disable any automatic update.</p> <p>If the IRD supports Fully Automatic mode the user must be able to disable Fully Automatic mode</p> <p>Depending on if the Nordig IRD is connectable or Non connectable the delivery alternatives and the update approaches can vary according to Nordig Unified 2.6 Table 10.1.</p>
<b>IRD Profile(s)</b>	Basic, IRD, FE
<b>Test procedure</b>	<p><b>Purpose of test:</b> To verify that the IRD has settings required for SSU end user functionality.</p> <p>This test is convenient to do parallel with Task 11:1 IRD System software update using DVB SSU simple profile</p> <p><b>Equipment:</b> Test setup described in 2.11.1 Test equipment summary</p> <p>Software to upgrade</p> <p>2 pcs IRDs with older software than the version to upgrade or older software to downgrade the IRD under testing.</p> <p><b>Test procedure:</b></p> <ol style="list-style-type: none"> <li>1. Verify that the IRD supports one of the described upgrade delivery alternatives and approach alternatives specified in [1].</li> <li>2. Fill in the test results.</li> <li>3. Verify that any notification to the user (pop-up message) related to SSU shall be displayed in the same language as the language setting of the IRD.</li> <li>4. Verify that the user is informed about the upgrade process if the SSU does not allow the normal utilization of the NorDig IRD.</li> <li>5. Verify the user can cancel the upgrade process</li> <li>6. Verify that if the user selects to abort/postpone an available update or by other ways cancel an available update, the NorDig IRD shall remind the user.</li> <li>7. Fill in the test results.</li> </ol> <p><b>Expected result:</b> All the test result are OK, and the available upgrade processes works as expected.</p>

<i>Test result(s)</i>	<b>Delivery alternatives</b>	<b>Non connectable IRD</b>	<b>OK or NOK or N/A</b>	<b>Internet connectable IRD</b>	<b>OK or NOK or N/A</b>
	#D1	Mandatory		Mandatory to implement at least one of the alternatives #D1, #D2 or #D3.	
	#D2	n/a			
	#D3	Optional			
	#D4	n/a		Optional	
	#D5	Optional		Optional	
	<b>Approach alternatives</b>	<b>Non connectable IRD</b>	<b>OK or NOK or N/A</b>	<b>Internet connectable IRD</b>	<b>OK or NOK or N/A</b>
	#A1	Mandatory to implement at least one of the alternatives #A1, #A2 or #A3.		Mandatory to implement at least one of the alternatives #A1, #A2, #A3 or #A4.	
	#A2				
	#A3				
#A4	Optional				
#A5	Optional		Optional		
				<b>OK or NOK</b>	
	IRD displays pop-up message with language selected in the settings				
	IRD informs user about upgrade process when applicable				
	User can cancel the ongoing upgrade process				
	User can abort/postpone available update				
	User is reminded about available update				
	User can disable Fully automatic mode.				
<i>Conformity</i>	<input type="checkbox"/> <b>OK Fault</b> <input type="checkbox"/> Major <input type="checkbox"/> Minor, define fail reason in comments				
<i>Comments</i>	If possible describe if fault can be fixed with software update: <input type="checkbox"/> <b>YES</b> <input type="checkbox"/> <b>NO</b> Describe more specific faults and/or other information				
<i>Date</i>			<i>Sign</i>		

<i>Test Case</i>	<b>Task 11:5 Common interface plus (CI+) CAM module system software update</b>
<i>Section</i>	NorDig Unified 10.6 and Content Security Extensions to the Common Interface. Version 1.4 (CI Plus specification)
<i>Requirement</i>	In the case of IRDs with CIP- CAM, the IRD shall also support to update the System Software on the CIP-CAM when such software is broadcast.  The IRD shall inform the user whether there is an IRD update or CIP-CAM update.
<i>IRD Profile(s)</i>	Basic, IDTV, FE



NorDig

<b>Test procedure</b>	<b>Purpose of test:</b> To verify the CI+ CAM module can be updated.  <b>Equipment:</b> Test setup described in 2.11.1 Test equipment summary  Software to upgrade  <b>Test procedure:</b> 1 Setup equipment for broadcast CI+ CAM update 2 Tune the IRD to the multiplex which is carrying the CI+ CAM update 3 Verify that CI+ CAM can be updated with CI+ IRD  <b>Expected result:</b> All test results are OK.
<b>Test result(s)</b>	
<b>Conformity</b>	<input type="checkbox"/> <b>OK</b> <input type="checkbox"/> <b>Fault</b> <input type="checkbox"/> Major <input type="checkbox"/> Minor, define fail reason in comments
<b>Comments</b>	If possible describe if fault can be fixed with software update: <input type="checkbox"/> <b>YES</b> <input type="checkbox"/> <b>NO</b> Describe more specific faults and/or other information
<b>Date</b>	<b>Sign</b>



**2.12 Task 12: Performance**

<b>Test Case</b>	<b>Task 12:1 Video performance</b>	
<b>Section</b>	NorDig Unified 11.2	
<b>Requirement</b>	Measurement results which comply with NorDig Unified requirements.	
<b>IRD Profile(s)</b>	Basic, IRD, FE	
<b>Test procedure</b>	<p><b>Purpose of test:</b> To verify video performance for RGB and PAL output signals.</p> <p>This test is mandatory if the IRD has analog video output.</p> <p><b>Test Equipment:</b> Test signals are created using the test bed shown below:</p> <pre> graph LR     A[MPEG 2-source] --&gt; B[Multiplex]     B --&gt; C[DVB-S/C/T Modulator]     C --&gt; D[Up Converter]     D --&gt; E[DVB Receiver]     E --&gt; F[Video analyzer]     G[PC Sigen] --- B           </pre> <p><b>Test signal configuration:</b> A transport stream containing a video signal with a number of Insertion Test Signals (ITS) is used. The signals employed for this test is a TV-line with black luminance, a TV-line containing the CCIR 17 test signal and a TV-line containing (sin x)/x pulses. Another transport stream containing CCIR 331 test signal is used to check chroma/luma intermodulation. LO Phase noise not measured.</p> <p><b>Test procedure:</b> Measurements of test signal response at RGB and PAL output</p>	
<b>Test result(s)</b>		
<b>Conformity</b>	<input type="checkbox"/> <b>OK Fault</b> <input type="checkbox"/> Major <input type="checkbox"/> Minor, define fail reason in comments	
<b>Comments</b>	If possible describe if fault can be fixed with software update: <input type="checkbox"/> <b>YES</b> <input type="checkbox"/> <b>NO</b> Describe more specific faults and/or other information	
<b>Date</b>		<b>Sign</b>

<b>Test Case</b>	<b>Task 12:2 Audio performance</b>	
<b>Section</b>	NorDig Unified 11.3	
<b>Requirement</b>	<p>Verify test protocol from manufacturer for compliance with NorDig Unified. The manufacturer shall also guarantee that data are typical for the IRD version in regular sale.</p> <p>The measured audio test items shall comply with NorDig Unified requirements (Table 11.1)</p>	
<b>IRD Profile(s)</b>	Basic, IRD, FE	
<b>Test procedure</b>	<b>Purpose of test:</b> Verify performance of audio output signals by checking test protocol from manufacturer.	

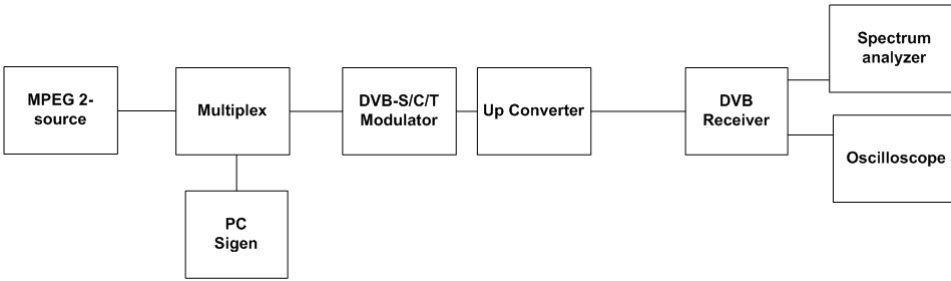
	<p>A limited number of measurements to verify basic audio performance.</p> <p>This test is mandatory if the has analog audio interface.</p> <p><b>Test Equipment:</b> Test signals are created using the test beds shown below:</p>  <pre> graph LR     A[MPEG 2-source] --&gt; B[Multiplex]     B --&gt; C[DVB-S/C/T Modulator]     C --&gt; D[Up Converter]     D --&gt; E[DVB Receiver]     E --&gt; F[Spectrum analyzer]     E --&gt; G[Oscilloscope]     H[PC Sigen] --&gt; B           </pre> <p><b>Test signal configuration:</b> Several transport streams containing various audio test signals is used. The audio signals used for this test includes:</p> <ul style="list-style-type: none"> <li>- Audio multiburst (L+R), 40 Hz to 15 kHz, - 6.0 dB<sub>r</sub>. Each burst with 1 s duration.</li> <li>- 40 sec audio burst (L+R), 1.0 kHz, 0.0 dB<sub>r</sub>, followed by 40 sec silence.</li> <li>- 1 sec audio bursts (R), 15 kHz, + 10.0 dB<sub>r</sub>. (L): silence.</li> </ul> <p><b>Test procedure:</b> Audio signal measurements</p> <p><b>Expected results:</b> Audio performance of the decoded digital audio signal in analog audio output comply with required NorDig Unified performance.</p> <p><b>Note:</b> 0 dB<sub>r</sub> refers to a level equal to full scale – 12 dB. (Full scale is the level where clipping starts to occur). 0 dB<sub>u</sub> refers to a voltage equal to 0.7446 V<sub>rms</sub>.</p>
--	---------------------------------------------------------------------------------------------------------------------------------------------------------------------------------------------------------------------------------------------------------------------------------------------------------------------------------------------------------------------------------------------------------------------------------------------------------------------------------------------------------------------------------------------------------------------------------------------------------------------------------------------------------------------------------------------------------------------------------------------------------------------------------------------------------------------------------------------------------------------------------------------------------------------------------------------------------------------------------------------------------------------------------------------------------------------------------------------------------------------------------------------------------------------------------------------------------------------------------------------------------------------------------------------------------------------------------------------------------------------------------------------------------------------------------------------------------------------------------------------------------------------------------------------------------

<b>Test result(s)</b>	
<b>Conformity</b>	<input type="checkbox"/> OK <input type="checkbox"/> Fault <input type="checkbox"/> Major <input type="checkbox"/> Minor, define fail reason in comments
<b>Comments</b>	If possible describe if fault can be fixed with software update: <input type="checkbox"/> YES <input type="checkbox"/> NO Describe more specific faults and/or other information
<b>Date</b>	<b>Sign</b>

<b>Test Case</b>	<b>Task 12:3 Zapping time</b>
<b>Section</b>	NorDig Unified 11.4
<b>Requirement</b>	<p>The NorDig IRD's zapping time for the services shall satisfy the requirements given in Table 11.2.</p> <p>The figures in Table 11.2 shall be met for an input signal which has:</p> <ul style="list-style-type: none"> <li>• video GOP length of 12,</li> <li>• a repetition rate of ECM of 2 per second (for scrambled services)</li> <li>• repetition rate of PAT and PMT of 10 times per second and</li> <li>• maximum PTS-to-PCR relative delay shall be 700ms.</li> </ul> <p>The picture on the display during the zapping time shall be either frozen or black and the</p>



	<p>sound shall be muted until the new session has been stabilised.</p> <p>The figures in the table are valid for two services on one multiplex as well as for two multiplexes and for both scrambled and unscrambled (FTA) services.</p>						
<b>IRD Profile(s)</b>	Basic, IRD, FE						
<b>Test procedure</b>	<p><b>Purpose of test:</b> Verify zapping times</p> <p><b>Test Equipment:</b> Test bed with a transport stream with different TV services, scrambled and non scrambled IRD under test</p> <p><b>Test procedure:</b></p> <ol style="list-style-type: none"> <li>1. A limited number of sample tests are done to check zapping times.</li> <li>2. Fill in test results</li> </ol> <p><b>Expected results:</b> Note: The figures in table shall be met for a GOP length of 12, a repetition rate of ECM of 2 per second and a repetition rate of PAT and PMT of 10 times per second. The picture on the display during the zapping time shall be either frozen or black and the sound shall be muted until the new session has been stabilised. The figures in the table are valid for any reception conditions.</p> <table border="1"> <thead> <tr> <th>IRD Type</th> <th>Average max zapping time</th> </tr> </thead> <tbody> <tr> <td>IRD with embedded CAS</td> <td>2.5 seconds</td> </tr> <tr> <td>IRD with CI and using a CAM</td> <td>3.5 seconds</td> </tr> </tbody> </table>	IRD Type	Average max zapping time	IRD with embedded CAS	2.5 seconds	IRD with CI and using a CAM	3.5 seconds
IRD Type	Average max zapping time						
IRD with embedded CAS	2.5 seconds						
IRD with CI and using a CAM	3.5 seconds						
<b>Test result(s)</b>	<table border="1"> <thead> <tr> <th>IRD Type</th> <th>Average max zapping time/s</th> </tr> </thead> <tbody> <tr> <td>IRD with embedded CAS</td> <td></td> </tr> <tr> <td>IRD with CI and using a CAM</td> <td></td> </tr> </tbody> </table>	IRD Type	Average max zapping time/s	IRD with embedded CAS		IRD with CI and using a CAM	
IRD Type	Average max zapping time/s						
IRD with embedded CAS							
IRD with CI and using a CAM							
<b>Conformity</b>	<input type="checkbox"/> <b>OK Fault</b> <input type="checkbox"/> Major <input type="checkbox"/> Minor, define fail reason in comments						
<b>Comments</b>	<p>If possible describe if fault can be fixed with software update: <input type="checkbox"/> <b>YES</b> <input type="checkbox"/> <b>NO</b></p> <p>Describe more specific faults and/or other information</p>						
<b>Date</b>	<table border="1"> <tr> <td></td> <td><b>Sign</b></td> <td></td> </tr> </table>		<b>Sign</b>				
	<b>Sign</b>						

## 2.13 Task 13: Service Information

### 2.13.1 General

These test tasks differ from the normal NorDig division of the test tasks. These test tasks are not listed in that order as the requirements appear in NorDig specification. Instead the order of the test tasks are divided in to a order how the different information data shall be able to be retrieved, handled and updated by the receiver. This division in this context is defined as following:

- Static PSI/SI data is defined as a data that must be updated by the receiver in the channel search or first time initialization.
- Quasi static PSI/SI data is defined as a data that must be updated by the receiver when it is toggled between stand-by mode and active mode or vice versa.
- Dynamic PSI/SI data is defined as a data that must be updated by the receiver whenever a change in the data occurs.

In order to maintain the reference to requirements, in every test task, the requirement from the specification is referenced.

<b>Test Case</b>	<b>Task 13:1 SI: General</b>
<b>Section</b>	NorDig Unified 12.1
<b>Requirement</b>	<p>The NorDig IRD shall at least start updating for any changes in the received “quasi-static” SI data after it returns to active from stand-by mode. “Quasi static” SI-data includes NIT and SDT, i.e. SI that is typically stored in the flash memory for service navigations, such as service name, service_ID, number of services.</p> <p>The NorDig IRD shall at least start action for any changes in the received “dynamic” PSI and SI data, (PMT, EIT, TDT/TOT, running status and CA mode) within 1 second. (As a guideline for the implementation, the trigger for changes in received tables can be based on comparing the ‘version id’ in the tables).</p>
<b>IRD Profile(s)</b>	Basic, IRD, FE
<b>Test procedure</b>	This is general requirement that will be test in following tests.

<b>Test Case</b>	<b>Task 13:2 SI: General – Undefined data structures</b>
<b>Section</b>	NorDig Unified 12.1
<b>Requirement</b>	Descriptors or other data structures that are currently undefined or are unknown to NorDig IRD shall be skipped and shall not cause any harm.
<b>IRD Profile(s)</b>	Basic, IRD, FE
<b>Test procedure</b>	<p><b>Purpose of test:</b> Confirm the proper function</p> <p><b>Test procedure:</b> It is a general requirement, which is tested, in the following tests.</p>

<b>Test Case</b>	<b>Task 13:3 SI: General – ‘Actual’ and ‘Other’ tables</b>
<b>Section</b>	NorDig Unified 12.1
<b>Requirement</b>	The IRD shall be able to process the PSI/SI tables, both for the ‘Actual’ and for ‘Other’ transport streams.



<b>IRD Profile(s)</b>	Basic, IRD, FE
<b>Test procedure</b>	This is a general requirement, which is tested, in the following tests.

<b>Test Case</b>	<b>Task 13:4 SI: SI data available through an API</b>
<b>Section</b>	NorDig Unified 12.1
<b>Requirement</b>	The NorDig IRD with an HbbTV-based profile (NorDig Hybrid shall support all the DVB SI additions as defined in the HbbTV v. 1.5 ETSI TS 102 796 v.1.2.1 specification [30].
<b>IRD Profile(s)</b>	Hybrid, IRD, FE
<b>Test procedure</b>	<p><b>In case of NorDig Basic without API:</b></p> <p>Not tested.</p> <p><b>In case of NorDig Enhanced:</b></p> <p>This test is part of the HbbTV Test Suite. Not tested here</p>

<b>Test Case</b>	<b>Task 13:5 SI: Text strings and field size of the SI descriptor</b>
<b>Section</b>	NorDig Unified 12.1.7
<b>Requirement</b>	The NorDig IRD shall support the character tables specified in Table 12.4.
<b>IRD Profile(s)</b>	Basic, IRD, FE
<b>Test procedure</b>	<p><b>Purpose of test:</b> Check the alphabet tables.</p> <p><b>Equipment:</b></p> <pre> graph LR     A[MPEG 2-source] --&gt; B[Multiplex]     B --&gt; C[DVB-S/C/T Modulator]     C --&gt; D[Up Converter]     D --&gt; E[DVB Receiver]     E --&gt; F[Monitor]     G[SI Inserter] --- B     </pre> <p>TS containing in SI tables Nordic characters defined in character table ‘Latin Alphabet number 5’.</p> <p><b>Test procedure:</b></p> <ol style="list-style-type: none"> <li>1. Play-out test stream containing SI tables with text strings that is coded “Latin Alphabet number 5”. Text strings in following SI tables shall be tested: <ul style="list-style-type: none"> <li>• NIT <ul style="list-style-type: none"> <li>○ network_name</li> <li>○ LCD v2.0 channel_list_name</li> </ul> </li> <li>• SDT <ul style="list-style-type: none"> <li>○ Service_name</li> </ul> </li> <li>• EIT <ul style="list-style-type: none"> <li>○ Short_event</li> <li>○ Extended_event</li> </ul> </li> </ul> </li> </ol>



	2. Verify that text strings are displayed as coded in “Latin Alphabet number 5”	
	<b>Expected result:</b> All text strings are displayed as defined.	
<b>Test result(s)</b>		
<b>Conformity</b>	<input type="checkbox"/> <b>OK</b> <input type="checkbox"/> <b>Fault</b> <input type="checkbox"/> Major <input type="checkbox"/> Minor, define fail reason in comments	
<b>Comments</b>	If possible describe if fault can be fixed with software update: <input type="checkbox"/> <b>YES</b> <input type="checkbox"/> <b>NO</b> Describe more specific faults and/or other information	
<b>Date</b>		<b>Sign</b>

### 2.13.2 Static PSI/SI data

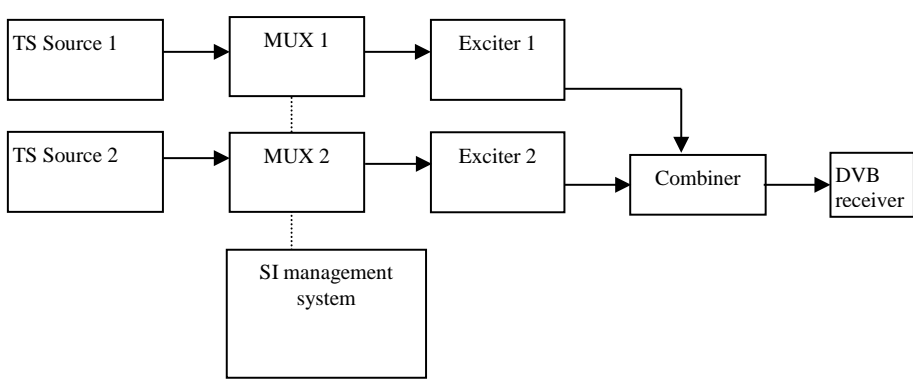
<b>Test Case</b>	<b>Task 13:6 NIT_actual – frequency_list_descriptor</b>	
<b>Section</b>	NorDig Unified 12.2.7	
<b>Requirement</b>	NIT descriptors mandatory to receive and interpret if broadcasted:  Network_name_descriptor Service_list_descriptor Terrestrial_delivery_system_descriptor Linkage_descriptor Private_data_specifier_descriptor Frequency_list_descriptor Nordig Logic_channel_descriptor	
<b>IRD Profile(s)</b>	Basic, IRD, DVB-T, DVB-T2	
<b>Test procedure</b>	<p><b>Purpose of test:</b> To check that when there is not correct center_frequency signalled in terrestrial_system_delivery_desc, but the alternative frequencies are available in Frequency_list_desc.</p> <p>Note: This test is only for terrestrial IRDs.</p> <p><b>Equipment:</b></p>  <pre> graph LR     TS1[TS Source 1] --&gt; MUX1[MUX 1]     TS2[TS Source 2] --&gt; MUX2[MUX 2]     MUX1 -.-&gt; SI[SI management system]     MUX2 -.-&gt; SI     MUX1 --&gt; Exc1[Exciter 1]     MUX2 --&gt; Exc2[Exciter 2]     Exc1 --&gt; Comb[Combiner]     Exc2 --&gt; Comb     Comb --&gt; DVB[DVB receiver]     </pre>	

	Service1	Service2	
<b>MUX1</b> TS_id 1 Network_id 1 ON_id <sup>1)</sup>	SID 1100 S_name Test11 S_type 0x01 PMT PID 1100 V PID 1109 A PID 1108 LCN 1 visible	SID 1200 S_name Test12 S_type 0x01 PMT PID 1200 V PID 1209 A PID 1208 LCN 2 visible	NIT: <sup>3)</sup> terrestrial_system_delivery_descriptor centre_frequency <i>f1</i> MHz  frequency_list_descriptor centre_frequency <i>f3</i> MHz
<b>MUX2</b> TS_id 2 Network_id 2 ON_id <sup>1)</sup>	SID 2100 S_name Test21 S_type 0x01 PMT PID 2100 V PID 2109 A PID 2108 LCN 3 visible	SID 2200 S_name Test22 S_type 0x01 PMT PID 2200 V PID 2209 A PID 2208 LCN 4 visible	
<p><sup>1)</sup> ON_id (Original_network_id) can be chosen in range 0x0001-0xfe00 (operational network) and it shall be same for both muxes.</p> <p><sup>3)</sup> Frequencies <i>f1</i>, <i>f2</i> and <i>f3</i> shall be different.</p> <p><b>Test procedure:</b></p> <ol style="list-style-type: none"> <li>1. Transmit MUX1 at frequency <i>f1</i> and MUX2 at frequency <i>f2</i>.</li> <li>2. Perform factory reset and new channel search.</li> <li>3. Verify that services on MUX1 can be received correctly.</li> <li>4. Zap to a service on MUX2.</li> <li>5. Change the MUX1 frequency to <i>f3</i>.</li> <li>6. Verify that the IRD is able to utilize the information given in the NIT frequency_list_descriptor and receive the services on MUX1.</li> <li>7. Transmit MUX1 at frequency <i>f2</i> and MUX2 at frequency <i>f1</i>.</li> <li>8. Perform factory reset and new channel search.</li> <li>9. Verify that services on MUX1 and MUX2 can be received correctly.</li> </ol> <p><b>Expected result:</b> Terrestrial IRD is able to follow the frequency_list_descriptor and tune to the services, if there is an incorrect frequency in the terrestrial_system_delivery_descriptor. Incorrect centre frequency in frequency_list_descriptor does not cause any harm for the reception.</p>			
<b>Test result(s)</b>			
<b>Conformity</b>	<input type="checkbox"/> OK <input type="checkbox"/> Fault <input type="checkbox"/> Major <input type="checkbox"/> Minor, define fail reason in comments		
<b>Comments</b>	If possible describe if fault can be fixed with software update: <input type="checkbox"/> YES <input type="checkbox"/> NO Describe more specific faults and/or other information		
<b>Date</b>		<b>Sign</b>	

<b>Test Case</b>	<b>Task 13:7 NIT_actual – Missing terrestrial_system_delivery_descriptor</b>
<b>Section</b>	NorDig Unified 12.2.4;
<b>Requirement</b>	NIT descriptors mandatory to receive and interpret if broadcasted:  Network_name_descriptor Service_list_descriptor Terrestrial_delivery_system_descriptor Linkage_descriptor Private_data_specifier_descriptor Frequency_list_descriptor

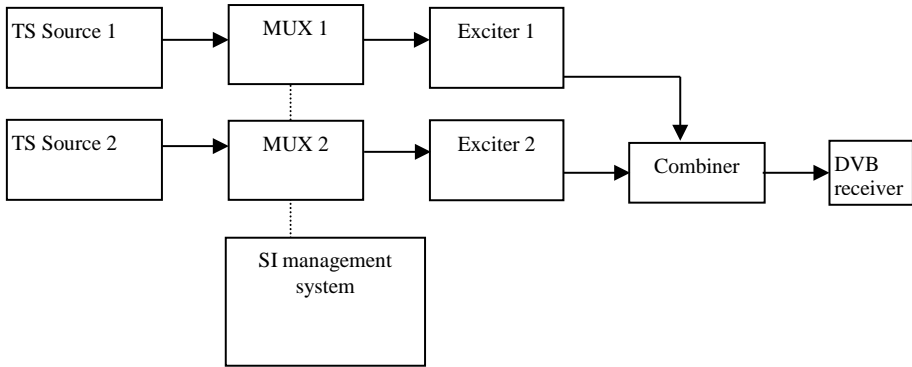
	Nordig Logic_channel_descriptor															
<b>IRD Profile(s)</b>	Basic, IRD, DVB-T, DVB-T2															
<b>Test procedure</b>	<p><b>Purpose of test:</b> To verify the functionality of the receiver when there is no terrestrial_system_delivery_desc signaled.</p> <p>Note: This test is only for terrestrial IRDs.</p> <p><b>Equipment:</b></p>  <table border="1" data-bbox="384 1019 1340 1393"> <thead> <tr> <th></th> <th>Service1</th> <th>Service2</th> <th></th> <th>Frequency</th> </tr> </thead> <tbody> <tr> <td><b>MUX1</b> TS_id 1 Network_id 1 ON_id <sup>1)</sup></td> <td>SID 1100 S_name Test11 S_type 0x01 PMT PID 1100 V PID 1109 A PID 1108 LCN 1 visible</td> <td>SID 1200 S_name Test12 S_type 0x01 PMT PID 1200 V PID 1209 A PID 1208 LCN 2 visible</td> <td>NIT: Missing terrestrial_system_delivery_desc</td> <td>666 MHz</td> </tr> <tr> <td><b>MUX2</b> TS_id 2 Network_id 2 ON_id <sup>1)</sup></td> <td>SID 2100 S_name Test21 S_type 0x01 PMT PID 2100 V PID 2109 A PID 2108 LCN 3 visible</td> <td>SID 2200 S_name Test22 S_type 0x01 PMT PID 2200 V PID 2209 A PID 2208 LCN 4 visible</td> <td></td> <td>730 MHz</td> </tr> </tbody> </table> <p><sup>1)</sup>ON_id (Original_network_id) can be chosen in range 0x0001-0xfe00 (operational network) and it shall be same for both muxes <sup>2)</sup>Network_id for DVB-C and DVB-S/S2 IRD tests shall be same in all muxes</p> <p><b>Test procedure:</b></p> <ol style="list-style-type: none"> <li>1. Remove the terrestrial_system_delivery_descriptor in MUX1</li> <li>2. Do channel search.</li> <li>3. Zap between a service on MUX1 and MUX2.</li> <li>4. Confirm that the reception of services in MUX1 and MUX2 is possible.</li> </ol> <p><b>Expected result:</b> The services are able to receive even when terrestrial_delivery_descriptor is missing.</p>		Service1	Service2		Frequency	<b>MUX1</b> TS_id 1 Network_id 1 ON_id <sup>1)</sup>	SID 1100 S_name Test11 S_type 0x01 PMT PID 1100 V PID 1109 A PID 1108 LCN 1 visible	SID 1200 S_name Test12 S_type 0x01 PMT PID 1200 V PID 1209 A PID 1208 LCN 2 visible	NIT: Missing terrestrial_system_delivery_desc	666 MHz	<b>MUX2</b> TS_id 2 Network_id 2 ON_id <sup>1)</sup>	SID 2100 S_name Test21 S_type 0x01 PMT PID 2100 V PID 2109 A PID 2108 LCN 3 visible	SID 2200 S_name Test22 S_type 0x01 PMT PID 2200 V PID 2209 A PID 2208 LCN 4 visible		730 MHz
	Service1	Service2		Frequency												
<b>MUX1</b> TS_id 1 Network_id 1 ON_id <sup>1)</sup>	SID 1100 S_name Test11 S_type 0x01 PMT PID 1100 V PID 1109 A PID 1108 LCN 1 visible	SID 1200 S_name Test12 S_type 0x01 PMT PID 1200 V PID 1209 A PID 1208 LCN 2 visible	NIT: Missing terrestrial_system_delivery_desc	666 MHz												
<b>MUX2</b> TS_id 2 Network_id 2 ON_id <sup>1)</sup>	SID 2100 S_name Test21 S_type 0x01 PMT PID 2100 V PID 2109 A PID 2108 LCN 3 visible	SID 2200 S_name Test22 S_type 0x01 PMT PID 2200 V PID 2209 A PID 2208 LCN 4 visible		730 MHz												
<b>Test result(s)</b>																
<b>Conformity</b>	<input type="checkbox"/> OK <input type="checkbox"/> Fault <input type="checkbox"/> Major <input type="checkbox"/> Minor, define fail reason in comments															
<b>Comments</b>	If possible describe if fault can be fixed with software update: <input type="checkbox"/> YES <input type="checkbox"/> NO Describe more specific faults and/or other information															

Date	Sign
------	------

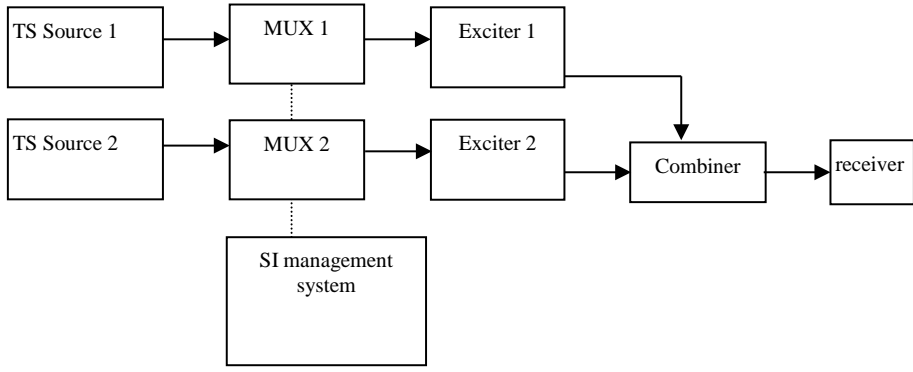
<b>Test Case</b>	<b>Task 13:8 NIT_actual – Missing T2_delivery_system_descriptor</b>															
<b>Section</b>	NorDig Unified 12.2.5;															
<b>Requirement</b>	<p>NIT descriptors mandatory to receive and interpret if broadcasted:</p> <p>Network_name_descriptor  Service_list_descriptor  Terrestrial_delivery_system_descriptor  Extension_descriptor  Linkage_descriptor  Private_data_specifier_descriptor  Frequency_list_descriptor  Nordig Logic_channel_descriptor</p> <p>T2_delivery_system_descriptor</p>															
<b>IRD Profile(s)</b>	Basic, IRD, DVB-T, DVB-T2															
<b>Test procedure</b>	<p><b>Purpose of test:</b>  To verify the functionality of the receiver for the missing T2_delivery_system_desc signaled through the extension_descriptor.</p> <p>Note: This test is only for terrestrial NorDig T2 IRDs.</p> <p><b>Equipment:</b></p>  <table border="1" data-bbox="383 1601 1300 1982"> <thead> <tr> <th></th> <th>Service1</th> <th>Service2</th> <th></th> <th>Frequency</th> </tr> </thead> <tbody> <tr> <td><b>MUX1</b> TS_id 1 Network_id 1 ON_id <sup>1)</sup></td> <td>SID 1100 S_name Test11 S_type 0x01 PMT PID 1100 V PID 1109 A PID 1108 LCN 1 visible</td> <td>SID 1200 S_name Test12 S_type 0x01 PMT PID 1200 V PID 1209 A PID 1208 LCN 2 visible</td> <td>NIT: Missing T2_ delivery_ system_ descriptor</td> <td>666 MHz</td> </tr> <tr> <td><b>MUX2</b> TS_id 2 Network_id 2 ON_id <sup>1)</sup></td> <td>SID 2100 S_name Test21 S_type 0x01 PMT PID 2100 V PID 2109 A PID 2108 LCN 3 visible</td> <td>SID 2200 S_name Test22 S_type 0x01 PMT PID 2200 V PID 2209 A PID 2208 LCN 4 visible</td> <td></td> <td>730 MHz</td> </tr> </tbody> </table> <p><sup>1)</sup> ON_id (Original_network_id) can be chosen in range 0x0001-0xfe00 (operational network) and</p>		Service1	Service2		Frequency	<b>MUX1</b> TS_id 1 Network_id 1 ON_id <sup>1)</sup>	SID 1100 S_name Test11 S_type 0x01 PMT PID 1100 V PID 1109 A PID 1108 LCN 1 visible	SID 1200 S_name Test12 S_type 0x01 PMT PID 1200 V PID 1209 A PID 1208 LCN 2 visible	NIT: Missing T2_ delivery_ system_ descriptor	666 MHz	<b>MUX2</b> TS_id 2 Network_id 2 ON_id <sup>1)</sup>	SID 2100 S_name Test21 S_type 0x01 PMT PID 2100 V PID 2109 A PID 2108 LCN 3 visible	SID 2200 S_name Test22 S_type 0x01 PMT PID 2200 V PID 2209 A PID 2208 LCN 4 visible		730 MHz
	Service1	Service2		Frequency												
<b>MUX1</b> TS_id 1 Network_id 1 ON_id <sup>1)</sup>	SID 1100 S_name Test11 S_type 0x01 PMT PID 1100 V PID 1109 A PID 1108 LCN 1 visible	SID 1200 S_name Test12 S_type 0x01 PMT PID 1200 V PID 1209 A PID 1208 LCN 2 visible	NIT: Missing T2_ delivery_ system_ descriptor	666 MHz												
<b>MUX2</b> TS_id 2 Network_id 2 ON_id <sup>1)</sup>	SID 2100 S_name Test21 S_type 0x01 PMT PID 2100 V PID 2109 A PID 2108 LCN 3 visible	SID 2200 S_name Test22 S_type 0x01 PMT PID 2200 V PID 2209 A PID 2208 LCN 4 visible		730 MHz												

	<p>it shall be same for both muxes.  <sup>2</sup>Network_id for DVB-C and DVB-S/S2 IRD tests shall be same in all muxes</p> <p><b>Test procedure:</b></p> <ol style="list-style-type: none"> <li>1. Remove the T2_delivery_system_descriptor in MUX1</li> <li>2. Do channel search.</li> <li>3. Zap between a service on MUX1 and MUX2.</li> <li>4. Confirm that the reception of services in MUX1 and MUX2 is possible.</li> </ol> <p><b>Expected result:</b>  The services are able to receive even when T2_delivery_system_descriptor is missing.</p>
<b>Test result(s)</b>	
<b>Conformity</b>	<input type="checkbox"/> <b>OK Fault</b> <input type="checkbox"/> Major <input type="checkbox"/> Minor, define fail reason in comments
<b>Comments</b>	If possible describe if fault can be fixed with software update: <input type="checkbox"/> <b>YES</b> <input type="checkbox"/> <b>NO</b> Describe more specific faults and/or other information
<b>Date</b>	<b>Sign</b>

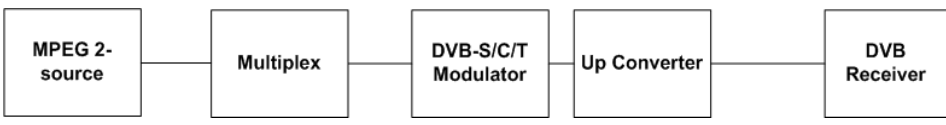
<b>Test Case</b>	<b>Task 13:9 SDT_actual service_descriptor and CA_identifier_descriptor</b>																																									
<b>Section</b>	NorDig Unified 12.2.6, 12.3.2 and 12.33																																									
<b>Requirement</b>	SDT descriptors mandatory to receive and interpret if broadcasted:  Service_descriptor CA_identifier_descriptor Linkage_descriptor																																									
<b>IRD Profile(s)</b>	Basic, IRD, FE																																									
<b>Test procedure</b>	<p><b>Purpose of test:</b>  To check the support for the Service descriptor and CA identifier descriptor.</p> <p><b>Equipment:</b></p>  <table border="1" data-bbox="391 1635 1324 1892"> <thead> <tr> <th></th> <th>Service1</th> <th>Service2</th> <th>Service3</th> <th>Frequency</th> </tr> </thead> <tbody> <tr> <td>MUX</td> <td>SID 1100</td> <td>SID 1200</td> <td>SID 1300</td> <td rowspan="7">Can be chosen depending of the distribution media</td> </tr> <tr> <td>TS_id 1</td> <td>Service type 0x01</td> <td>Service type 0x02</td> <td>Service type 0x0C</td> </tr> <tr> <td>Network_id 1</td> <td>S_name Test11</td> <td>S_name Test12</td> <td>S_name Test13</td> </tr> <tr> <td>ON_id <sup>1)</sup></td> <td>PMT PID 1100</td> <td>PMT PID 1200</td> <td>PMT PID 1300</td> </tr> <tr> <td></td> <td>V PID 1109</td> <td>V PID 1209</td> <td>V PID 1309</td> </tr> <tr> <td></td> <td>A PID 1108</td> <td>A PID 1208</td> <td>A PID 1308</td> </tr> <tr> <td></td> <td>Logical_chan_desc 1 visible</td> <td>Logical_chan_desc 2 visible</td> <td>Logical_chan_desc 3 visible</td> </tr> <tr> <td></td> <td>Encrypted</td> <td>Clear</td> <td>Clear</td> </tr> </tbody> </table> <p><sup>1)</sup>ON_id (Original_network_id) can be chosen in range 0x0001-0xfe00 (operational network)</p> <p>CA_identifier_descriptor may be present in the SDT when at least one service component is scrambled. The CA_system_id is allocated by ETSI and is given by ETR</p>					Service1	Service2	Service3	Frequency	MUX	SID 1100	SID 1200	SID 1300	Can be chosen depending of the distribution media	TS_id 1	Service type 0x01	Service type 0x02	Service type 0x0C	Network_id 1	S_name Test11	S_name Test12	S_name Test13	ON_id <sup>1)</sup>	PMT PID 1100	PMT PID 1200	PMT PID 1300		V PID 1109	V PID 1209	V PID 1309		A PID 1108	A PID 1208	A PID 1308		Logical_chan_desc 1 visible	Logical_chan_desc 2 visible	Logical_chan_desc 3 visible		Encrypted	Clear	Clear
	Service1	Service2	Service3	Frequency																																						
MUX	SID 1100	SID 1200	SID 1300	Can be chosen depending of the distribution media																																						
TS_id 1	Service type 0x01	Service type 0x02	Service type 0x0C																																							
Network_id 1	S_name Test11	S_name Test12	S_name Test13																																							
ON_id <sup>1)</sup>	PMT PID 1100	PMT PID 1200	PMT PID 1300																																							
	V PID 1109	V PID 1209	V PID 1309																																							
	A PID 1108	A PID 1208	A PID 1308																																							
	Logical_chan_desc 1 visible	Logical_chan_desc 2 visible	Logical_chan_desc 3 visible																																							
	Encrypted	Clear	Clear																																							

	<p>162. The descriptor may be used statically (recommended). It will in that case be set according to the services regular/normal scrambling status. Alternatively it may be used dynamically, in accordance with the current services scrambling status. This static use enables IRDs to “grey mark” services that cannot be descrambled due to lack of the required CA-system for the relevant service(s). It allows the IRD to display services that are only temporary (event based) scrambled.</p> <p><b>Test procedure:</b></p> <ol style="list-style-type: none"> <li>1. Verify that CA_identifier_descriptor is signaled in SDT_actual for another CA_system_id than supported by the receiver. If the receiver doesn't support any CA system, the used CA system in EIT_actual p/f can have any valid CA_system_id.</li> <li>2. Do the first time initialization or a channel search</li> <li>3. Verify that the service1 is displayed as non-available, e.g. “grey marked”.</li> </ol> <p><b>Expected result:</b> The service1 is displayed as non-available by the receiver.</p>
<b>Test result(s)</b>	
<b>Conformity</b>	<input type="checkbox"/> OK Fault <input type="checkbox"/> Major <input type="checkbox"/> Minor, define fail reason in comments
<b>Comments</b>	If possible describe if fault can be fixed with software update: <input type="checkbox"/> YES <input type="checkbox"/> NO Describe more specific faults and/or other information
<b>Date</b>	<b>Sign</b>

### 2.13.3 Quasi static PSI/SI data

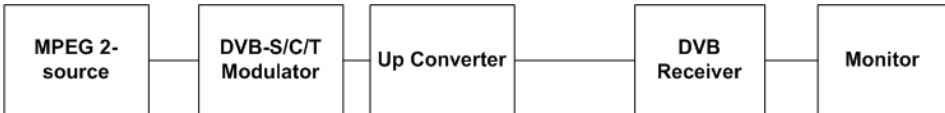
<b>Test Case</b>	<b>Task 13:10 Quasi static update of SDT_actual</b>
<b>Section</b>	NorDig Unified 12.1.1
<b>Requirement</b>	The IRD shall at least start updating for any changes in the received “quasi-static” SI data, (NIT and SDT i.e. SI that is normally stored in the flash memory for service navigations such as service_name, service_ID, number of services), after it return to active from stand-by mode.
<b>IRD Profile(s)</b>	Basic, IRD, FE
<b>Test procedure</b>	<p><b>Purpose of test:</b> To verify the quasi-static use of the SDT_actual information.</p> <p><b>Equipment:</b></p>  <pre> graph LR     A[MPEG 2-source] --- B[DVB-S/C/T Modulator]     B --- C[Up Converter]     C --- D[DVB Receiver]     D --- E[Monitor]   </pre> <p><b>Test procedure:</b></p> <ol style="list-style-type: none"> <li>1. Change the information in SDT;       <ol style="list-style-type: none"> <li>a. service_name</li> <li>b. service_ID</li> </ol> </li> <li>2. Check that the changes are triggered by toggling the receiver from active mode to stand-by mode and vice versa</li> </ol>

	<p>Additionally changed tables / descriptors write down in comments which information is changed.</p> <p><b>Expected result:</b> Changes are triggered and made..</p>		
<b>Test result(s)</b>	<p>Update is made:</p> <p><input type="checkbox"/> From active mode to stand-by mode</p> <p><input type="checkbox"/> From stand-by mode to active mode</p> <p><input type="checkbox"/> In stand-by mode</p>		
<b>Conformity</b>	<p><input type="checkbox"/> <b>OK Fault</b> <input type="checkbox"/> Major <input type="checkbox"/> Minor, define fail reason in comments</p>		
<b>Comments</b>	<p>If possible describe if fault can be fixed with software update: <input type="checkbox"/> <b>YES</b> <input type="checkbox"/> <b>NO</b></p> <p>Describe more specific faults and/or other information</p>		
<b>Date</b>	<table border="1" style="width: 100%;"> <tr> <td style="width: 50%;"></td> <td style="width: 50%; text-align: center;"><i>Sign</i></td> </tr> </table>		<i>Sign</i>
	<i>Sign</i>		

<b>Test Case</b>	<b>Task 13:11 Quasi-static update of SDT_actual – linkage to NorDig simulcast replacement service</b>
<b>Section</b>	NorDig Unified 12.3.4
<b>Requirement</b>	<p>0x82, NorDig Simulcast replacement service, linkage from an (MPEG2 ) SDTV based service to an (MPEG4 AVC) HDTV replacement service with the same content. It may be used during simulcasting of a service in both an SDTV and an HDTV version on separate service ids with same content within the same original network id. This linkage may be included in the (MPEG2) SDTV service (service_type 0x01) within the SDT pointing to the HDTV version (service_type 0x19) of the service. Whenever it is used, it will be used quasi-static.</p> <p>When an SDTV service includes this NorDig simulcast replacement service linkage (0x82) pointing to the HDTV version of the service, the NorDig HD IRDs that are able to receive both the SDTV and the HDTV services shall only include the HDTV version/(service) of the two services within its TV service list.</p> <p>(Clarification: If no ‘NorDig Simulcast replacement service’ linkage is included, both services shall be included. If only the (MPEG-2) SDTV version (service_type 0x01) is possible to receive (due to e.g. reception problems/limitations), the (HDTV) IRD shall include this service even if it carries a linkage ‘NorDig simulcast replacement service’).</p>
<b>IRD Profile(s)</b>	Basic, IRD, FE
<b>Test procedure</b>	<p><b>Purpose of test:</b> To verify the support for the linkage to simulcast replacement service in SDT_actual.</p> <p><b>Equipment:</b></p>

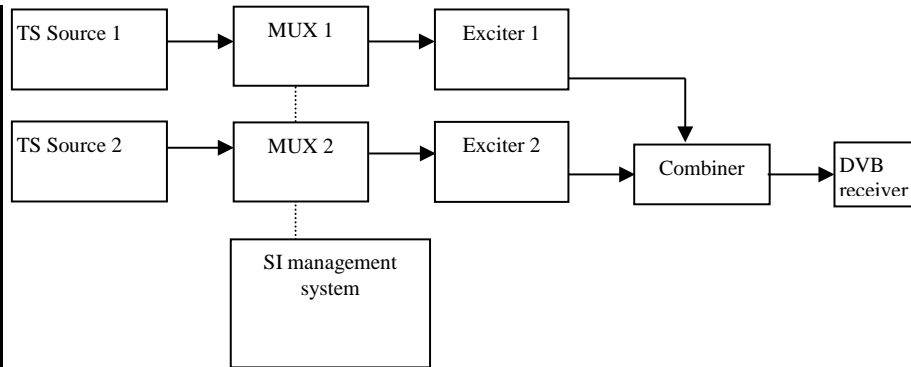

	Service1	Service2	Frequency
<b>MUX1</b> TS_id 1 Network_id 1 ON_id <sup>1)</sup>	SID 1100 S_name Test11 S_type 0x01 PMT PID 1100 V PID 1109 A PID 1108 LCN Ver.1: 1 visible LCN Ver.2: 1 visible	SID 1200 S_name Test12 S_type 0x19 PMT PID 1200 V PID 1209 A PID 1208 LCN Ver.1: 2 visible LCN Ver.2: 2 visible	Can be chosen depending of the distribution media
<b>MUX2</b> TS_id 2 Network_id 2 ON_id <sup>1)</sup>	SID 2100 S_name Test21 S_type 0x01 PMT PID 2100 V PID 2109 A PID 2108 LCN Ver.1: 3 visible LCN Ver.2: 3 visible  SDT_actuallinkage_desc: NorDig Simulcast replacement service pointing to service2 on MUX1	SID 2200 S_name Test22 S_type 0x01 PMT PID 2200 V PID 2209 A PID 2208 LCN Ver.1: 4 visible LCN Ver.2: 4 visible	Can be chosen depending of the distribution media, but cannot be same as in MUX1

<sup>1)</sup>ON\_id (Original\_network\_id) can be chosen in range 0x0001-0xfe00 (operational network) and it shall be same for both muxes.

<sup>2)</sup>Network\_id for DVB-C and DVB-S/S2 IRD tests shall be same in all muxes

Note 1: NorDig Simulcast replacement service has value 0x82 in linkage\_descriptor.

Note 2: Service2 in MUX2 is only for convenience that the HDTV receiver stores service2 MUX2 in the service list.

**Test procedure:**

1. Verify that the SDT\_actuallinkage\_descriptor to a simulcast replacement service1 in MUX2 points to service2 in MUX1.
2. Verify following services are able to be received and decoded:
  - Test11, Test12 and Test22
3. Remove SDT\_actual linkage\_descriptor 0x82 from SDT\_actual in MUX2
4. Toggle receiver to standby and power on it
5. Verify following services are able to be received and decoded:
  - Test11, Test12, Test21 and Test22
6. Add SDT\_actual linkage\_descriptor 0x82 to SDT\_actual in MUX2
7. Toggle receiver to standby and power on it
8. Verify following services are able to be received and decoded:
  - Test11, Test12 and Test22
  -

**Expected result:**



	<p>Verify that receiver stores only HDTV service (service2 in MUX1) instead of simulcast SDTV service (service1 in MUX2) when linkage_descriptor is signaled.</p> <p>Verify that receiver is able to receive and decode both HDTV service (service2 in MUX1) and simulcast SDTV service (service1 in MUX2) when linkage_descriptor is not signaled after updating service information quasi-statically.</p> <p>Verify that receiver stores only HDTV service (service2 in MUX1) instead of simulcast SDTV service (service1 in MUX2) when linkage_descriptor is signaled after updating service information quasi-statically.</p>
<b>Test result(s)</b>	<p>Update is made:</p> <p><input type="checkbox"/> From active mode to stand-by mode</p> <p><input type="checkbox"/> From stand-by mode to active mode</p> <p><input type="checkbox"/> In stand-by mode</p>
<b>Conformity</b>	<p><input type="checkbox"/> <b>OK Fault</b> <input type="checkbox"/> Major <input type="checkbox"/> Minor, define fail reason in comments</p>
<b>Comments</b>	<p>If possible describe if fault can be fixed with software update: <input type="checkbox"/> <b>YES</b> <input type="checkbox"/> <b>NO</b></p> <p>Describe more specific faults and/or other information</p>
<b>Date</b>	<p><b>Sign</b></p>

<b>Test Case</b>	<b>Task 13:12 Quasi-static update of NIT_actual – Linkage to an information service about the network</b>
<b>Section</b>	NorDig Unified 12.2.6
<b>Requirement</b>	<p>NIT Linkage descriptors mandatory to receive and interpret if broadcasted:</p> <p>0x01 Linkage to an information service about the network</p> <p>0x02 Linkage to EPG service</p> <p>0x04 Linkage to transport stream that carries EIT Schedule information for all services</p> <p>0x09 Linkage to DVB/ETSI System Software Download Service</p>
<b>IRD Profile(s)</b>	Basic, IRD, FE
<b>Test procedure</b>	<p><b>Purpose of test:</b></p> <p>To check the support for the Linkage to an information service about the network descriptor.</p> <p><b>Test procedure:</b></p> <p>From the receiver point of view the linkage to an information service about the network, is practically read dynamically when the user request that information. However, the information of the the linkage to an information service about the network content can be updated when toggling between active mode and standby mode for faster access. The NorDig specification defines the NIT_actual as quasi-static data and therefore this test is classified as quasi-static.</p> <p><b>This requirement is tested only with API.</b></p>
<b>Test result(s)</b>	
<b>Conformity</b>	<p><input type="checkbox"/> <b>OK Fault</b> <input type="checkbox"/> Major <input type="checkbox"/> Minor, define fail reason in comments</p>
<b>Comments</b>	<p>If possible describe if fault can be fixed with software update: <input type="checkbox"/> <b>YES</b> <input type="checkbox"/> <b>NO</b></p>

	Describe more specific faults and/or other information		
<i>Date</i>		<i>Sign</i>	

<b>Test Case</b>	<b>Task 13:13 Quasi-static update of NIT_actual – Linkage to EPG service</b>
------------------	------------------------------------------------------------------------------

<b>Section</b>	NorDig Unified 12.2.6
----------------	-----------------------

<b>Requirement</b>	<p>NIT Linkage descriptors mandatory to receive and interpret if broadcasted:</p> <p>0x01 Linkage to an information service about the network</p> <p>0x02 Linkage to EPG service</p> <p>0x04 Linkage to transport stream that carries EIT Schedule information for all services</p> <p>0x09 Linkage to DVB/ETSI System Software Download Service</p>
--------------------	------------------------------------------------------------------------------------------------------------------------------------------------------------------------------------------------------------------------------------------------------------------------------------------------------------------------------------------------------

<b>IRD Profile(s)</b>	Basic, IRD, FE
-----------------------	----------------

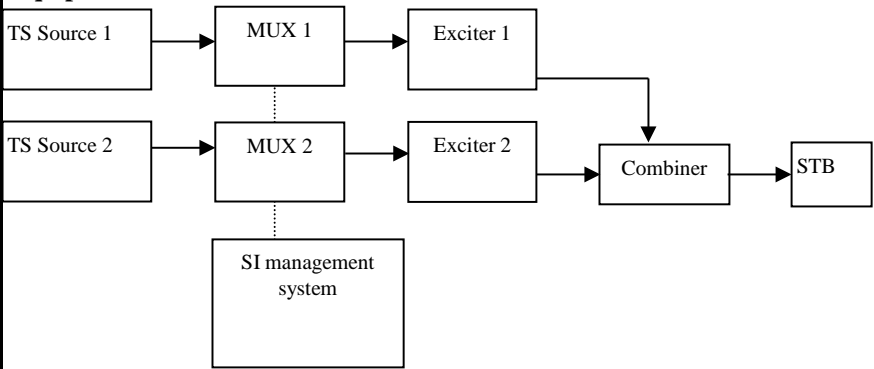
<b>Test procedure</b>	<p><b>Purpose of test:</b> To check the support for the Linkage to EPG service descriptor. To test the use of the linkage_descriptor 0x02 founded in NIT.</p> <p><b>Equipment:</b></p>  <pre> graph LR     TS1[TS Source 1] --&gt; MUX1[MUX 1]     TS2[TS Source 2] --&gt; MUX2[MUX 2]     MUX1 -.- SI[SI management system]     MUX2 -.- SI     MUX1 --&gt; Exc1[Exciter 1]     MUX2 --&gt; Exc2[Exciter 2]     Exc1 --&gt; Comb[Combiner]     Exc2 --&gt; Comb     Comb --&gt; STB[STB]     </pre>
-----------------------	---------------------------------------------------------------------------------------------------------------------------------------------------------------------------------------------------------------------------------------------------------------------------------------------------------------------------------------------------------------------------------------------------------------------------------------------------------------------------------------------------------------------------------------------------------------------------------------------

	<b>Service1</b>	<b>Service2</b>		<b>Frequency</b>
<b>MUX1</b> TS_id 1 Network_id 1 ON_id <sup>1)</sup>	SID 1100 S_name Test11 PMT PID 1100 V PID 1109 A PID 1108 Logical_chan_desc 1 visible	SID 1200 S_name Test12 PMT PID 1200 V PID 1209 A PID 1208 Logical_chan_desc 2 visible	NIT: Linkage to EPG service at SID 2200	Can be chosen depending of the distribution media.
<b>MUX2</b> TS_id 2 Network_id 2 ON_id <sup>1)</sup>	SID 2100 S_name Test21 PMT PID 2100 V PID 2109 A PID 2108 Logical_chan_desc 3 visible	SID 2200 S_name Test22 PMT PID 2200 V PID 2209 A PID 2208 Logical_chan_desc 0 not visible	NIT: Linkage to EPG service at SID 2200	Can be chosen depending of the distribution media. Not same as for Exciter 1

<sup>1)</sup> ON\_id (Original\_network\_id) can be chosen in range 0x0001-0xfe00 (operational network) and it shall be same for both muxes

<sup>2)</sup> Network\_id for DVB-C and DVB-S/S2 IRD tests shall be same in all muxes

**Test procedure:**

From the receiver point of view, the linkage to EPG service, is practically read dynamically when the user request the EPG. However, the information of the linkage to

	<p>EPG content can be updated when toggling between active mode and standby mode for faster access. The NorDig specification defines the NIT_actual as quasi-static data and therefore this test is classified as quasi-static.</p> <ol style="list-style-type: none"> <li>1. Check that there is an EPG service available in the stream at SID 2200.</li> <li>2. Press the guide button and check that EPG is started.</li> <li>3. Change a parameter in the linkage to EPG content</li> <li>4. Toggle between active mode and standby mode.</li> <li>5. If it is relevant, note if the data content in the linkage is updated.</li> </ol> <p><b>Expected result:</b> The EPG is started. (Not relevant for NorDig Basic)</p>
<i>Test result(s)</i>	
<i>Conformity</i>	<input type="checkbox"/> <b>OK</b> <input type="checkbox"/> <b>Fault</b> <input type="checkbox"/> Major <input type="checkbox"/> Minor, define fail reason in comments
<i>Comments</i>	If possible describe if fault can be fixed with software update: <input type="checkbox"/> <b>YES</b> <input type="checkbox"/> <b>NO</b> Describe more specific faults and/or other information
<i>Date</i>	<i>Sign</i>

<i>Test Case</i>	<b>Task 13:14 Quasi-static update of NIT_actual – Linkage to TS that carries EIT sch information for all services</b>
<i>Section</i>	NorDig Unified 12.2.6
<i>Requirement</i>	Linkage_type 0x04 (“Transport stream containing complete network/bouquet SI”) is used for this purpose.
<i>IRD Profile(s)</i>	Basic, IRD, FE
<i>Test procedure</i>	<p>From the receiver point of view, the linkage to TS that carries EIT sch information for all services, is practically read dynamically when the user request that information. However, the information of the the linkage to TS that carries EIT sch information for all services content can be updated when toggling between active mode and standby mode for faster access. The NorDig specification defines the NIT_actual as quasi-static data and therefore this test is classified as quasi-static.</p> <p><b>This requirement is tested in Task 8:44.</b></p>

<i>Test Case</i>	<b>Task 13:15 Quasi-static update of NIT_actual – Linkage to System Software Download service</b>
<i>Section</i>	NorDig Unified 12.2.6
<i>Requirement</i>	<p>NIT Linkage descriptors mandatory to receive and interpret if broadcasted:</p> <p>0x09 Linkage to DVB/ETSI System Software Download Service</p>
<i>IRD Profile(s)</i>	Basic, IRD, FE
<i>Test procedure</i>	<p><b>Purpose of test:</b> To check the support for the Linkage to DVB/ETSI System Software Download Service</p> <p><b>Test procedure:</b></p> <p><b>This requirement is tested in Test Task 11.</b></p>

2.13.4 Dynamic PSI/SI data

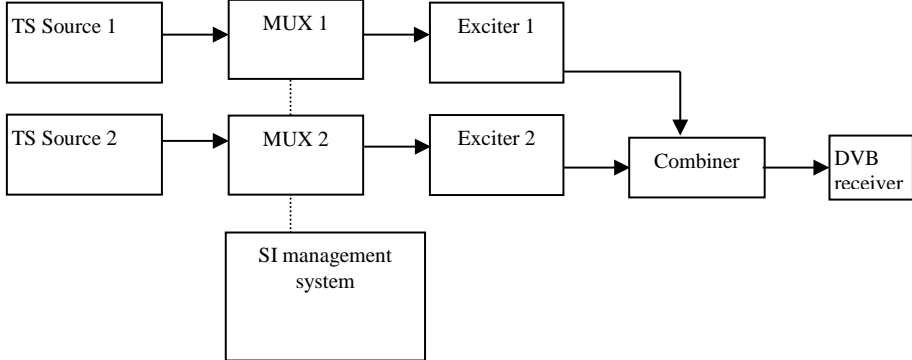
<b>Test Case</b>	<b>Task 13:16 Dynamic update of SDT_actual running status and linkage to a service replacement service</b>																		
<b>Section</b>	NorDig Unified 12.1 and 12.3.4																		
<b>Requirement</b>	<p>SDT descriptors mandatory to receive and interpret if broadcasted:</p> <p>Linkage_descriptor</p> <p>0x05, linkage to a service replacement service. When present, the receiver shall automatically switch to the replacement service if the 'running_status' is set to "1" (not running) and if the receiver are able to receive the SDT containing the original service during the replacement, also switch back when 'running_status' is set to "4" (running).</p>																		
<b>IRD Profile(s)</b>	Basic, IRD, FE																		
<b>Test procedure</b>	<p><b>Purpose of test:</b> To check the support for the Linkage to service replacement service in SDT.</p> <p><b>Equipment:</b></p>  <table border="1" data-bbox="384 1373 1332 1821"> <thead> <tr> <th></th> <th>Service1</th> <th>Service2</th> <th></th> <th>Frequency</th> </tr> </thead> <tbody> <tr> <td><b>MUX1</b> TS_id 1 Network_id 1 ON_id <sup>1)</sup></td> <td>SID 1100 S_name Test11 S_type 0x01 PMT PID 1100 V PID 1109 A PID 1108 LCN 1 visible</td> <td>SID 1200 S_name Test12 S_type 0x01 PMT PID 1200 V PID 1209 A PID 1208 LCN 2 visible</td> <td></td> <td>Can be chosen depending of the distribution media</td> </tr> <tr> <td><b>MUX2</b> TS_id 2 Network_id 2 ON_id <sup>1)</sup></td> <td>SID 2100 S_name Test21 S_type 0x01 PMT PID 2100 V PID 2109 A PID 2108 LCN 3 visible</td> <td>SID 2200 S_name Test22 S_type 0x01 PMT PID 2200 V PID 2209 A PID 2208 LCN 4 visible</td> <td>SDT: linkage_descriptor 0x05 pointing to service1 on MUX2</td> <td>Can be chosen depending of the distribution media, but cannot be same as in MUX1</td> </tr> </tbody> </table> <p><sup>1)</sup> ON_id (Original_network_id) can be chosen in range 0x0001-0xfe00 (operational network) and it shall be same for both muxes <sup>2)</sup> Network_id for DVB-C and DVB-S/S2 IRD tests shall be same in all muxes</p> <p><b>Test procedure:</b></p>					Service1	Service2		Frequency	<b>MUX1</b> TS_id 1 Network_id 1 ON_id <sup>1)</sup>	SID 1100 S_name Test11 S_type 0x01 PMT PID 1100 V PID 1109 A PID 1108 LCN 1 visible	SID 1200 S_name Test12 S_type 0x01 PMT PID 1200 V PID 1209 A PID 1208 LCN 2 visible		Can be chosen depending of the distribution media	<b>MUX2</b> TS_id 2 Network_id 2 ON_id <sup>1)</sup>	SID 2100 S_name Test21 S_type 0x01 PMT PID 2100 V PID 2109 A PID 2108 LCN 3 visible	SID 2200 S_name Test22 S_type 0x01 PMT PID 2200 V PID 2209 A PID 2208 LCN 4 visible	SDT: linkage_descriptor 0x05 pointing to service1 on MUX2	Can be chosen depending of the distribution media, but cannot be same as in MUX1
	Service1	Service2		Frequency															
<b>MUX1</b> TS_id 1 Network_id 1 ON_id <sup>1)</sup>	SID 1100 S_name Test11 S_type 0x01 PMT PID 1100 V PID 1109 A PID 1108 LCN 1 visible	SID 1200 S_name Test12 S_type 0x01 PMT PID 1200 V PID 1209 A PID 1208 LCN 2 visible		Can be chosen depending of the distribution media															
<b>MUX2</b> TS_id 2 Network_id 2 ON_id <sup>1)</sup>	SID 2100 S_name Test21 S_type 0x01 PMT PID 2100 V PID 2109 A PID 2108 LCN 3 visible	SID 2200 S_name Test22 S_type 0x01 PMT PID 2200 V PID 2209 A PID 2208 LCN 4 visible	SDT: linkage_descriptor 0x05 pointing to service1 on MUX2	Can be chosen depending of the distribution media, but cannot be same as in MUX1															

	<ol style="list-style-type: none"> <li>1. Verify that all service have running_status 4 (running)</li> <li>2. Verify that all services are able to be received and decoded</li> <li>3. Choose the service2 on MUX1</li> <li>4. Change running_status of service2 on MUX1 to 1 (not running)</li> <li>5. Verify that receiver receives and decodes service1 on MUX2</li> </ol> <p><b>Expected result:</b></p> <p>Verify that receiver receives and decodes service1 on MUX2.</p>
<b>Test result(s)</b>	
<b>Conformity</b>	<input type="checkbox"/> <b>OK Fault</b> <input type="checkbox"/> Major <input type="checkbox"/> Minor, define fail reason in comments
<b>Comments</b>	If possible describe if fault can be fixed with software update: <input type="checkbox"/> <b>YES</b> <input type="checkbox"/> <b>NO</b> Describe more specific faults and/or other information
<b>Date</b>	<b>Sign</b>

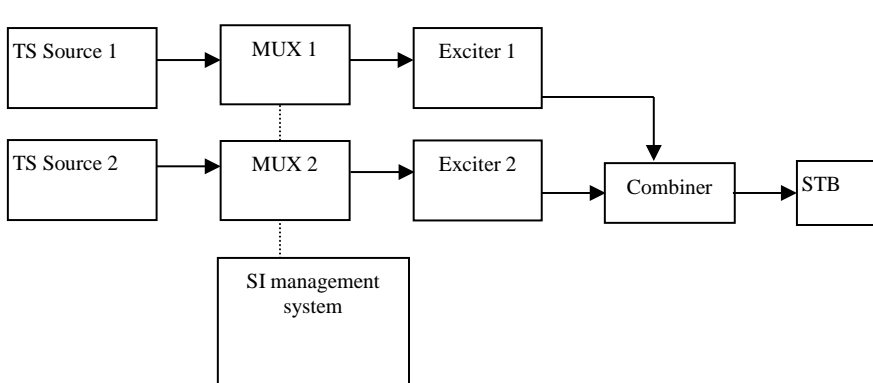
<b>Test Case</b>	<b>Task 13:17 Dynamic update of EIT actual/other p/f</b>																						
<b>Section</b>	NorDig Unified 13.3.2																						
<b>Requirement</b>	<p>NorDig IRD shall make use of the EIT p/f tables from both EIT_actual and EIT_other tables.</p> <p>The NorDig IRD manufacturer shall provide a procedure that allows the user to configure blanking of video and muting of sound for certain parental rating values.</p> <p>If information is missing (i.e. not included in the transmission) the ESG shall <u>not</u> display an error message, instead the text information field shall stay empty (i.e. no information like “no information available”).</p>																						
<b>IRD Profile(s)</b>	Basic, IRD, FE																						
<b>Test procedure</b>	<p><b>Purpose of test:</b> To check that relevant contents of the EIT actual/other p/f are decoded and displayed correctly.</p> <p><b>Equipment:</b></p>  <pre> graph LR     TS1[TS Source 1] --&gt; MUX1[MUX 1]     TS2[TS Source 2] --&gt; MUX2[MUX 2]     MUX1 -.- SI[SI management system]     MUX2 -.- SI     MUX1 --&gt; Exc1[Exciter 1]     MUX2 --&gt; Exc2[Exciter 2]     Exc1 --&gt; Comb[Combiner]     Exc2 --&gt; Comb     Comb --&gt; STB[STB]     </pre> <table border="1" style="width: 100%; border-collapse: collapse;"> <thead> <tr> <th></th> <th><b>Service1</b></th> <th><b>Service2</b></th> <th></th> <th><b>Frequency</b></th> </tr> </thead> <tbody> <tr> <td><b>MUX1</b></td> <td>SID 1100</td> <td>SID 1200</td> <td rowspan="4">EIT actual/other p/f</td> <td rowspan="4">Can be chosen depending of the</td> </tr> <tr> <td>TS_id 1</td> <td>S_name Test11</td> <td>S_name Test12</td> </tr> <tr> <td>Network_id 1</td> <td>PMT PID 1100</td> <td>PMT PID 1200</td> </tr> <tr> <td>ON_id<sup>1)</sup></td> <td>V PID 1109</td> <td>V PID 1209</td> </tr> </tbody> </table>					<b>Service1</b>	<b>Service2</b>		<b>Frequency</b>	<b>MUX1</b>	SID 1100	SID 1200	EIT actual/other p/f	Can be chosen depending of the	TS_id 1	S_name Test11	S_name Test12	Network_id 1	PMT PID 1100	PMT PID 1200	ON_id <sup>1)</sup>	V PID 1109	V PID 1209
	<b>Service1</b>	<b>Service2</b>		<b>Frequency</b>																			
<b>MUX1</b>	SID 1100	SID 1200	EIT actual/other p/f	Can be chosen depending of the																			
TS_id 1	S_name Test11	S_name Test12																					
Network_id 1	PMT PID 1100	PMT PID 1200																					
ON_id <sup>1)</sup>	V PID 1109	V PID 1209																					

	A PID 1108 Logical_chan_desc 1 visible	A PID 1208 Logical_chan_desc 2 visible		distribution media.
<b>MUX2</b> TS_id 2 Network_id 2 ON_id <sup>1)</sup>	SID 2100 S_name Test21 PMT PID 2100 V PID 2109 A PID 2108 Logical_chan_desc 3 visible	SID 2200 S_name Test22 S_type 0x01 PMT PID 2200 V PID 2209 A PID 2208 Logical_chan_desc 4 visible	EIT actual/other p/f	Can be chosen depending of the distribution media. Not same as for Exciter 1
<p><sup>1)</sup>ON_id (Original_network_id) can be chosen in range 0x0001-0xfe00 (operational network) and it shall be same for both muxes.</p> <p><sup>2)</sup>Network_id for DVB-C and DVB-S/S2 IRD tests shall be same in all muxes</p> <p><b>Test procedure:</b></p> <ol style="list-style-type: none"> <li>1. Verify that there is one visible service with EIT information signalled on MUX1, one visible service without EIT signalled on MUX1 and one service with EIT signalled on MUX2.</li> <li>2. Launch navigator.</li> <li>3. Check that service with and without EIT signalled is displayed correctly.</li> <li>4. Verify that the EIT p/f has priority over EIT schedule in navigator (in case if the EIT p/f and EIT schedule has a conflict in EIT information)</li> </ol> <p><b>Expected result:</b></p> <p>The IRD shall display the information signalled in EIT from MUX1 and MUX2 correctly in navigator inclusive all the descriptor defined above.</p> <p>The IRD shall not display error message for the service, which don't have EIT signalled, on MUX1.</p> <p>The ESG has equal layout for all services in one service type.</p>				
<b>Test result(s)</b>				
<b>Conformity</b>	<input type="checkbox"/> <b>OK</b> <input type="checkbox"/> <b>Fault</b> <input type="checkbox"/> Major <input type="checkbox"/> Minor, define fail reason in comments			
<b>Comments</b>	If possible describe if fault can be fixed with software update: <input type="checkbox"/> <b>YES</b> <input type="checkbox"/> <b>NO</b> Describe more specific faults and/or other information			
<b>Date</b>		<b>Sign</b>		

<b>Test Case</b>	<b>Task 13:18 Dynamic update of EIT_actual p/f CA_identifier_descriptor</b>
<b>Section</b>	NorDig Unified 12.4.3
<b>Requirement</b>	EIT_actual p/f descriptors mandatory to receive and interpret if broadcasted:  CA_identifier_descriptor  This descriptor is optional, however, it may be present in the EIT whenever at least one service component is scrambled. The CA_system_id is allocated by ETSI and is given by ETR 162 [16]. When used, it will be used dynamically, i.e. following the services scrambling status, mainly targeting the ESG/EPG applications.
<b>IRD Profile(s)</b>	Basic, IRD, DVB-T, DVB-T2
<b>Test procedure</b>	<b>Purpose of test:</b>

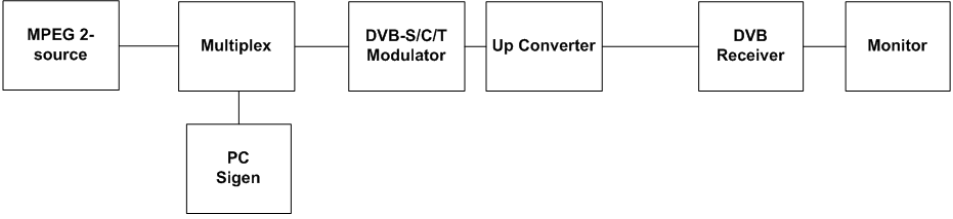
	<p>To verify the support for the dynamic interpretation of the CA_identifier_descriptor in EIT_actual p/f.</p> <p>This test is optional for satellite and cable IRD.</p> <p><b>Equipment:</b></p>  <table border="1" data-bbox="391 705 1348 958"> <thead> <tr> <th></th> <th>Service1</th> <th>Service2</th> <th>Frequency</th> </tr> </thead> <tbody> <tr> <td><b>MUX1</b></td> <td>SID 1100</td> <td>SID 1200</td> <td rowspan="2">Can be chosen depending of the distribution media</td> </tr> <tr> <td>TS_id 1</td> <td>S_name Test11</td> <td>S_name Test12</td> </tr> <tr> <td>Network_id 1</td> <td>PMT PID 1100</td> <td>PMT PID 1200</td> <td></td> </tr> <tr> <td>ON_id <sup>1)</sup></td> <td>V PID 1109</td> <td>V PID 1209</td> <td></td> </tr> <tr> <td></td> <td>A PID 1108</td> <td>A PID 1208</td> <td></td> </tr> <tr> <td></td> <td>Logical_chan_desc 1 visible</td> <td>Logical_chan_desc 2 visible</td> <td></td> </tr> <tr> <td></td> <td></td> <td>EIT: CA_identifier_descriptor signaled for a CA_system_id</td> <td></td> </tr> </tbody> </table> <p><sup>1)</sup>ON_id (Original_network_id) can be chosen in range 0x0001-0xfe00 (operational network) and it shall be same for both muxes</p> <p><sup>2)</sup>Network_id for DVB-C and DVB-S/S2 IRD tests shall be same in all muxes</p> <p><b>Test procedure:</b></p> <ol style="list-style-type: none"> <li>1. Verify that CA_identifier_descriptor is signaled for a service2 next event_id in EIT_actual p/f for a CA_system_id supported by the receiver. If the receiver doesn't support any CA system, the used CA system in EIT_actual p/f can have any valid CA_system_id.</li> <li>2. Verify by accessing the ESG or EPG that the event is marked as scrambled.</li> </ol> <p><b>Expected result:</b> The event is marked as scrambled in the ESG or EPG.</p>		Service1	Service2	Frequency	<b>MUX1</b>	SID 1100	SID 1200	Can be chosen depending of the distribution media	TS_id 1	S_name Test11	S_name Test12	Network_id 1	PMT PID 1100	PMT PID 1200		ON_id <sup>1)</sup>	V PID 1109	V PID 1209			A PID 1108	A PID 1208			Logical_chan_desc 1 visible	Logical_chan_desc 2 visible				EIT: CA_identifier_descriptor signaled for a CA_system_id	
	Service1	Service2	Frequency																													
<b>MUX1</b>	SID 1100	SID 1200	Can be chosen depending of the distribution media																													
TS_id 1	S_name Test11	S_name Test12																														
Network_id 1	PMT PID 1100	PMT PID 1200																														
ON_id <sup>1)</sup>	V PID 1109	V PID 1209																														
	A PID 1108	A PID 1208																														
	Logical_chan_desc 1 visible	Logical_chan_desc 2 visible																														
		EIT: CA_identifier_descriptor signaled for a CA_system_id																														
<b>Test result(s)</b>																																
<b>Conformity</b>	<input type="checkbox"/> OK <input type="checkbox"/> Fault <input type="checkbox"/> Major <input type="checkbox"/> Minor, define fail reason in comments																															
<b>Comments</b>	If possible describe if fault can be fixed with software update: <input type="checkbox"/> YES <input type="checkbox"/> NO Describe more specific faults and/or other information																															
<b>Date</b>	<b>Sign</b>																															
<b>Test Case</b>	<b>Task 13:19 Dynamic update of EIT actual/other p/f short_event_descriptor, extended_event_descriptor and content_descriptor</b>																															
<b>Section</b>	NorDig Unified 12.4																															
<b>Requirement</b>	EIT descriptors mandatory to receive and interpret if broadcasted:  Short_event_descriptor Extended_event_descriptor Component_descriptor																															

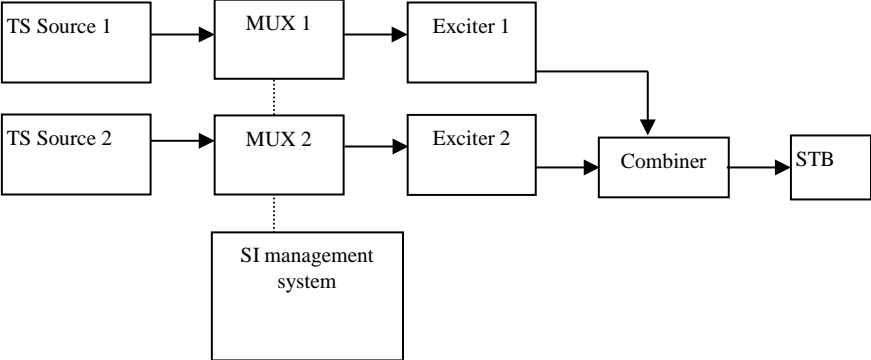
	Content_descriptor Parental_rating_descriptor Private_data_specifier_descriptor															
<b>IRD Profile(s)</b>	Basic, IRD, FE															
<b>Test procedure</b>	<p><b>Purpose of test:</b>          To check the support for the following descriptors in EIT actual/other p/f:          Short_event_descriptor          Extended_event_descriptor          Content_descriptor</p> <p><b>Equipment:</b></p>  <table border="1" data-bbox="389 1048 1347 1424"> <thead> <tr> <th></th> <th>Service1</th> <th>Service2</th> <th></th> <th>Frequency</th> </tr> </thead> <tbody> <tr> <td><b>MUX1</b> TS_id 1 Network_id 1 ON_id <sup>1)</sup></td> <td>SID 1100 S_name Test11 PMT PID 1100 V PID 1109 A PID 1108 Logical_chan_desc 1 visible</td> <td>SID 1200 S_name Test12 PMT PID 1200 V PID 1209 A PID 1208 Logical_chan_desc 2 visible</td> <td></td> <td>Can be chosen depending of the distribution media.</td> </tr> <tr> <td><b>MUX2</b> TS_id 2 Network_id 2 ON_id <sup>1)</sup></td> <td>SID 2100 S_name Test21 PMT PID 2100 V PID 2109 A PID 2108 Logical_chan_desc 3 visible</td> <td>SID 2200 S_name Test22 PMT PID 2200 V PID 2209 A PID 2208 Logical_chan_desc 4 visible</td> <td>Bouquet SI All information in EIT.</td> <td>Can be chosen depending of the distribution media. Not same as for Exciter 1</td> </tr> </tbody> </table> <p><sup>1)</sup>ON_id (Original_network_id) can be chosen in range 0x0001-0xfe00 (operational network) and it shall be same for both muxes  <sup>2)</sup>Network_id for DVB-C and DVB-S/S2 IRD tests shall be same in all muxes</p> <p><b>Test procedure:</b></p> <ol style="list-style-type: none"> <li>1. Check that the descriptors above are signalled for the two tables EIT actual and other p/f</li> <li>2. Choose a service which have descriptors signalled and access the info banner.</li> <li>3. Check that the information on info banner is correct (EIT actual p/f).</li> <li>4. Keep the same channel, but zap using the info banner to an other service.</li> <li>5. Check that the information on info banner is correct (EIT other p/f).</li> <li>6. Change the information in content_descriptor to Movie/Drama, News/Current affairs, Show/Game show, Sports, Children's/Youth programmes, Music/Ballet/Dance, Arts/Culture (without music), Social/Political issues/Economics, Education/ Science/Factual topics and Leisure hobbies, in hexadecimal values 0x1 – 0xA respectively.</li> </ol>		Service1	Service2		Frequency	<b>MUX1</b> TS_id 1 Network_id 1 ON_id <sup>1)</sup>	SID 1100 S_name Test11 PMT PID 1100 V PID 1109 A PID 1108 Logical_chan_desc 1 visible	SID 1200 S_name Test12 PMT PID 1200 V PID 1209 A PID 1208 Logical_chan_desc 2 visible		Can be chosen depending of the distribution media.	<b>MUX2</b> TS_id 2 Network_id 2 ON_id <sup>1)</sup>	SID 2100 S_name Test21 PMT PID 2100 V PID 2109 A PID 2108 Logical_chan_desc 3 visible	SID 2200 S_name Test22 PMT PID 2200 V PID 2209 A PID 2208 Logical_chan_desc 4 visible	Bouquet SI All information in EIT.	Can be chosen depending of the distribution media. Not same as for Exciter 1
	Service1	Service2		Frequency												
<b>MUX1</b> TS_id 1 Network_id 1 ON_id <sup>1)</sup>	SID 1100 S_name Test11 PMT PID 1100 V PID 1109 A PID 1108 Logical_chan_desc 1 visible	SID 1200 S_name Test12 PMT PID 1200 V PID 1209 A PID 1208 Logical_chan_desc 2 visible		Can be chosen depending of the distribution media.												
<b>MUX2</b> TS_id 2 Network_id 2 ON_id <sup>1)</sup>	SID 2100 S_name Test21 PMT PID 2100 V PID 2109 A PID 2108 Logical_chan_desc 3 visible	SID 2200 S_name Test22 PMT PID 2200 V PID 2209 A PID 2208 Logical_chan_desc 4 visible	Bouquet SI All information in EIT.	Can be chosen depending of the distribution media. Not same as for Exciter 1												



	<p>7. Check that the changes are updated in info banner.</p> <p><b>Expected result:</b> The info banner shows the information signalled in descriptors above and it is changed the information is updated.</p>	
<i>Test result(s)</i>		
<i>Conformity</i>	<input type="checkbox"/> <b>OK Fault</b> <input type="checkbox"/> Major <input type="checkbox"/> Minor, define fail reason in comments	
<i>Comments</i>	<p>If possible describe if fault can be fixed with software update: <input type="checkbox"/> <b>YES</b> <input type="checkbox"/> <b>NO</b> Describe more specific faults and/or other information</p>	
<i>Date</i>		<i>Sign</i>

<i>Test Case</i>	<p><b>Task 13:20 Dynamic update of EIT actual/other p/f content descriptor and component_descriptor</b></p>																													
<i>Section</i>	NorDig Unified 12.4																													
<i>Requirement</i>	<p>EIT descriptors mandatory to receive and interpret if broadcasted:</p> <p>Short_event_descriptor Extended_event_descriptor Component_descriptor Content_descriptor Parental_rating_descriptor Private_data_specifier_descriptor CA_identifier_descriptor (optional)</p>																													
<i>IRD Profile(s)</i>	Basic, IRD, FE																													
<i>Test procedure</i>	<p><b>Purpose of test:</b> To check the support for the following descriptors in EIT p/f: Content_descriptor (because it is needed in component descriptor) Component_descriptor</p> <p>This test is a subset of the all combinations of values defined for content_descriptor / component_descriptor. The following combinations are tested:</p> <table border="1" data-bbox="386 1491 1331 1877"> <thead> <tr> <th>Stream_content</th> <th>Component_desc</th> <th>Language</th> </tr> </thead> <tbody> <tr> <td>0x01</td> <td>0x01 MPEG2 SD video, 4:3, 25Hz</td> <td>swe/fin/nor/dan/ice/sami</td> </tr> <tr> <td>0x01</td> <td>0x03 MPEG2 SD video, 16:9, 25Hz without pan vectors</td> <td>swe/fin/nor/dan/ice/sami</td> </tr> <tr> <td>0x02</td> <td>0x01 MPEG1 LII Audio mono</td> <td>swe/fin/nor/dan/ice/sami</td> </tr> <tr> <td>0x02</td> <td>0x02 MPEG1 LII Audio dual mono</td> <td>swe/fin/nor/dan/ice/sami</td> </tr> <tr> <td>0x02</td> <td>0x03 MPEG1 LII Audio stereo (2 channel)</td> <td>swe/fin/nor/dan/ice/sami</td> </tr> <tr> <td>0x05</td> <td>0x01 MPEG4 AVC SD video, 4:3, 25Hz</td> <td>swe/fin/nor/dan/ice/sami</td> </tr> <tr> <td>0x05</td> <td>0x03 MPEG4 AVC SD video, 16:9, 25Hz</td> <td>swe/fin/nor/dan/ice/sami</td> </tr> <tr> <td>0x05</td> <td>0x0B MPEG4 AVC HD video, 16:9, 25Hz</td> <td>swe/fin/nor/dan/ice/sami</td> </tr> </tbody> </table> <p><b>Equipment:</b></p>			Stream_content	Component_desc	Language	0x01	0x01 MPEG2 SD video, 4:3, 25Hz	swe/fin/nor/dan/ice/sami	0x01	0x03 MPEG2 SD video, 16:9, 25Hz without pan vectors	swe/fin/nor/dan/ice/sami	0x02	0x01 MPEG1 LII Audio mono	swe/fin/nor/dan/ice/sami	0x02	0x02 MPEG1 LII Audio dual mono	swe/fin/nor/dan/ice/sami	0x02	0x03 MPEG1 LII Audio stereo (2 channel)	swe/fin/nor/dan/ice/sami	0x05	0x01 MPEG4 AVC SD video, 4:3, 25Hz	swe/fin/nor/dan/ice/sami	0x05	0x03 MPEG4 AVC SD video, 16:9, 25Hz	swe/fin/nor/dan/ice/sami	0x05	0x0B MPEG4 AVC HD video, 16:9, 25Hz	swe/fin/nor/dan/ice/sami
Stream_content	Component_desc	Language																												
0x01	0x01 MPEG2 SD video, 4:3, 25Hz	swe/fin/nor/dan/ice/sami																												
0x01	0x03 MPEG2 SD video, 16:9, 25Hz without pan vectors	swe/fin/nor/dan/ice/sami																												
0x02	0x01 MPEG1 LII Audio mono	swe/fin/nor/dan/ice/sami																												
0x02	0x02 MPEG1 LII Audio dual mono	swe/fin/nor/dan/ice/sami																												
0x02	0x03 MPEG1 LII Audio stereo (2 channel)	swe/fin/nor/dan/ice/sami																												
0x05	0x01 MPEG4 AVC SD video, 4:3, 25Hz	swe/fin/nor/dan/ice/sami																												
0x05	0x03 MPEG4 AVC SD video, 16:9, 25Hz	swe/fin/nor/dan/ice/sami																												
0x05	0x0B MPEG4 AVC HD video, 16:9, 25Hz	swe/fin/nor/dan/ice/sami																												

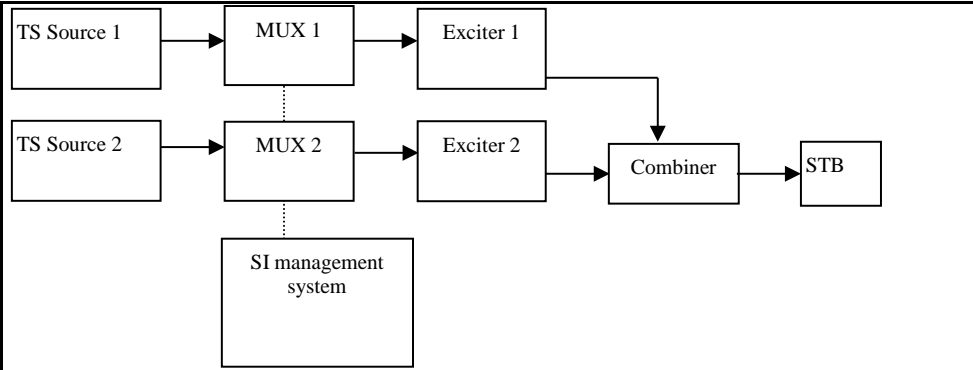

	<b>Service1</b>	<b>Service2</b>		<b>Frequency</b>
<b>MUX1</b> TS_id 1 Network_id 1 ON_id <sup>1)</sup>	SID 1100 S_name Test11 S_type 0x01 PMT PID 1100 V PID 1109 A PID 1108 LCN 1 visible	SID 1200 S_name Test12 S_type 0x01 PMT PID 1200 V PID 1209 A PID 1208 LCN 2 visible		Can be chosen depending of the distribution media.
<b>MUX2</b> TS_id 2 Network_id 2 ON_id <sup>1)</sup>	SID 2100 S_name Test21 S_type 0x19 PMT PID 2100 V PID 2109 A PID 2108 LCN 3 visible	SID 2200 S_name Test22 S_type 0x16 PMT PID 2200 V PID 2209 A PID 2208 LCN 4 visible	Bouquet SI All information in EIT.	Can be chosen depending of the distribution media. Not same as for Exciter 1

<sup>1)</sup>ON\_id (Original\_network\_id) can be chosen in range 0x0001-0xfe00 (operational network) and it shall be same for both muxes.

<sup>2)</sup>Network\_id for DVB-C and DVB-S/S2 IRD tests shall be same in all muxes

**Test procedure:**

1. Check that these descriptors doesn't cause any harm for the receiver and the content of the component descriptor is displayed correctly.

**Expected result:**

Content\_descriptor and component\_descriptor don't cause any harm if they are not visible.

Content\_descriptor and component\_descriptor are decoded correctly if they are visible in info banner or/and ESG.

<b>Test result(s)</b>	
<b>Conformity</b>	<input type="checkbox"/> <b>OK</b> <input type="checkbox"/> <b>Fault</b> <input type="checkbox"/> Major <input type="checkbox"/> Minor, define fail reason in comments
<b>Comments</b>	If possible describe if fault can be fixed with software update: <input type="checkbox"/> <b>YES</b> <input type="checkbox"/> <b>NO</b> Describe more specific faults and/or other information
<b>Date</b>	<b>Sign</b>

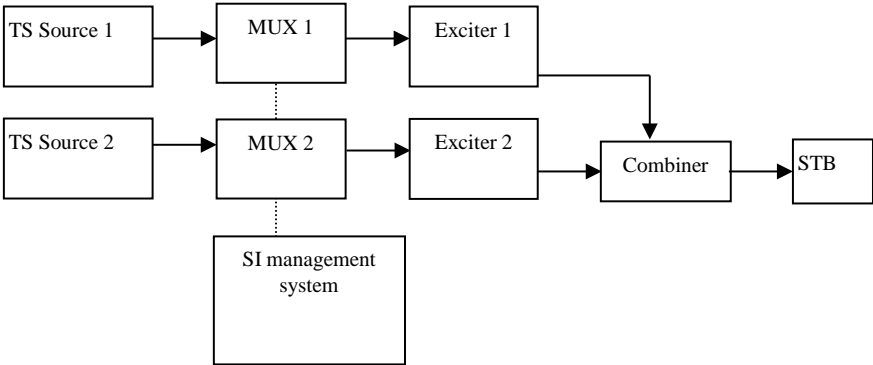
<b>Test Case</b>	<b>Task 13:21 Dynamic update of EIT actual/other p/f parental_rating_descriptor</b>																		
<b>Section</b>	NorDig Unified 13.3.2																		
<b>Requirement</b>	The IRD manufacturer shall provide a procedure that allows the user to configure blanking of video and muting of sound for certain parental rating values (in parental_rating_descriptor in the EIT p/f).																		
<b>IRD Profile(s)</b>	Basic, IRD, FE																		
<b>Test procedure</b>	<p><b>Purpose of test:</b> To check that muting of audio and blanking of video works.</p> <p><b>Equipment:</b></p>  <table border="1" data-bbox="387 1072 1347 1473"> <thead> <tr> <th></th> <th>Service1</th> <th>Service2</th> <th></th> <th>Frequency</th> </tr> </thead> <tbody> <tr> <td><b>MUX1</b> TS_id 1 Network_id 1 ON_id <sup>1)</sup></td> <td>SID 1100 S_name Test11 S_type 0x01 PMT PID 1100 V PID 1109 A PID 1108 LCN 1 visible</td> <td>SID 1200 S_name Test12 S_type 0x01 PMT PID 1200 V PID 1209 A PID 1208 LCN 2 visible</td> <td></td> <td>Can be chosen depending of the distribution media.</td> </tr> <tr> <td><b>MUX2</b> TS_id 2 Network_id 2 ON_id <sup>1)</sup></td> <td>SID 2100 S_name Test21 S_type 0x01 PMT PID 2100 V PID 2109 A PID 2108 LCN 3 visible</td> <td>SID 2200 S_name Test22 S_type 0x01 PMT PID 2200 V PID 2209 A PID 2208 LCN 4 visible</td> <td>Bouquet SI All information in EIT.</td> <td>Can be chosen depending of the distribution media. Not same as for Exciter 1</td> </tr> </tbody> </table> <p><sup>1)</sup>ON_id (Original_network_id) can be chosen in range 0x0001-0xfe00 (operational network) and it shall be same for both muxes <sup>2)</sup>Network_id for DVB-C and DVB-S/S2 IRD tests shall be same in all muxes</p> <p><b>Test procedure:</b></p> <ol style="list-style-type: none"> <li>1. Verify that current program has lower parental_rating than the parental_rating settings allowed in the preferences of the IRD on MUX 1.</li> <li>2. Zap to channel and verify that video is visible</li> <li>3. Verify that next program in the current a services EIT information is signalled for higher parental_rating as allowed in preferences of the IRD on MUX1</li> <li>4. Watch service and verify that EIT present information is updated to the next program</li> <li>5. Verify that the video is blanked and the audio is muted.</li> <li>6. Watch the service until the EIT event information is changed to next program, which has the lower parental_rating as allowed in the preferences.</li> <li>7. Verify that the video is visible and audio is audible after EIT_present update.</li> </ol>					Service1	Service2		Frequency	<b>MUX1</b> TS_id 1 Network_id 1 ON_id <sup>1)</sup>	SID 1100 S_name Test11 S_type 0x01 PMT PID 1100 V PID 1109 A PID 1108 LCN 1 visible	SID 1200 S_name Test12 S_type 0x01 PMT PID 1200 V PID 1209 A PID 1208 LCN 2 visible		Can be chosen depending of the distribution media.	<b>MUX2</b> TS_id 2 Network_id 2 ON_id <sup>1)</sup>	SID 2100 S_name Test21 S_type 0x01 PMT PID 2100 V PID 2109 A PID 2108 LCN 3 visible	SID 2200 S_name Test22 S_type 0x01 PMT PID 2200 V PID 2209 A PID 2208 LCN 4 visible	Bouquet SI All information in EIT.	Can be chosen depending of the distribution media. Not same as for Exciter 1
	Service1	Service2		Frequency															
<b>MUX1</b> TS_id 1 Network_id 1 ON_id <sup>1)</sup>	SID 1100 S_name Test11 S_type 0x01 PMT PID 1100 V PID 1109 A PID 1108 LCN 1 visible	SID 1200 S_name Test12 S_type 0x01 PMT PID 1200 V PID 1209 A PID 1208 LCN 2 visible		Can be chosen depending of the distribution media.															
<b>MUX2</b> TS_id 2 Network_id 2 ON_id <sup>1)</sup>	SID 2100 S_name Test21 S_type 0x01 PMT PID 2100 V PID 2109 A PID 2108 LCN 3 visible	SID 2200 S_name Test22 S_type 0x01 PMT PID 2200 V PID 2209 A PID 2208 LCN 4 visible	Bouquet SI All information in EIT.	Can be chosen depending of the distribution media. Not same as for Exciter 1															

	<p>8. Verify that the EIT p/f has priority over EIT schedule in navigator (in case if the EIT p/f and EIT schedule has a conflict in EIT information)</p> <p><b>Expected result:</b></p> <p>The IRD shall blank the video and mute the audio for ages that are not allowed to decode.</p>
<b>Test result(s)</b>	
<b>Conformity</b>	<input type="checkbox"/> <b>OK</b> <input type="checkbox"/> <b>Fault</b> <input type="checkbox"/> <b>Major</b> <input type="checkbox"/> <b>Minor</b> , define fail reason in comments
<b>Comments</b>	<p>If possible describe if fault can be fixed with software update: <input type="checkbox"/> <b>YES</b> <input type="checkbox"/> <b>NO</b></p> <p>Describe more specific faults and/or other information</p>
<b>Date</b>	<b>Sign</b>

<b>Test Case</b>	<b>Task 13:22 Dynamic update of EIT actual/other p/f and schedule in ESG using linkage</b>
<b>Section</b>	NorDig Unified 12.4.7, 12.2.6, 13.3.1 and 13.3.2
<b>Requirement</b>	<p>Upon user request for EIT schedule information, the IRD shall look for the reference using linkage descriptor mechanism in the NIT and perform a frequency re-tuning if necessary. Linkage_type 0x04 (“Transport Stream containing complete network/bouquet SI”) shall be used to refer to EIT schedule information.</p> <p>The ESG shall include the EIT present/following table.</p> <p>The NorDig IRD shall be able to handle situations when the EIT is not present.</p> <p>The ESG shall be non-discriminatory and display all services on equal basis.</p> <p>The ESG shall process and display the relevant content of the following tables (including start time, end time/duration, and content of all descriptors specified below</p> <p>If information is missing (i.e. not included in the transmission) the ESG shall <u>not</u> display an error message, instead the text information field shall stay empty (i.e. no information like “no information available”).</p> <p>Short_event_desc          Extended_event_desc          Component_desc          Content_desc          Parental_rating_desc          CA_identifier_descriptor (optional)</p>
<b>IRD Profile(s)</b>	Basic, IRD, FE
<b>Test procedure</b>	<p><b>Purpose of test:</b></p> <p>To verify the dynamic update of EIT actual/other schedule information in ESG using the linkage_descriptor 0x04 (“Transport Stream containing complete network/bouquet SI”) in NIT.</p> <p>The verify the handling of the EIT schedule descriptors in NorDig Basic receiver:</p> <p>Short_event_descriptor          Component_descriptor          Extend_event_descriptor          Parental_rating_descriptor</p>

**Equipment:**

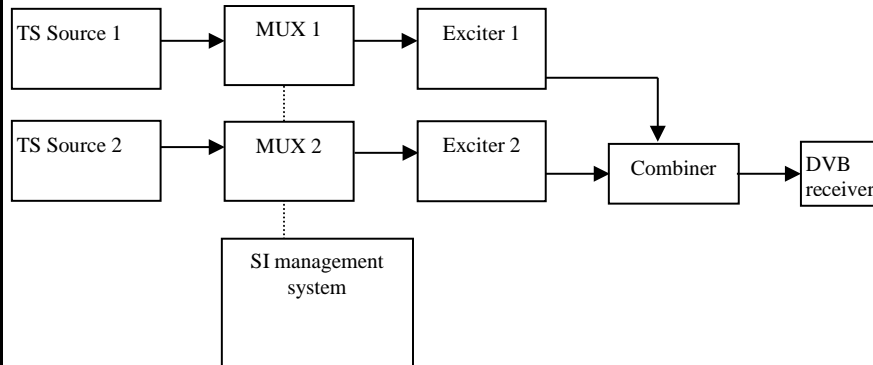

	Service1	Service2		Frequency
<b>MUX1</b> TS_id 1 Network_id 1 ON_id <sup>1)</sup>	SID 1100 S_name Test11 S_type 0x01 PMT PID 1100 V PID 1109 A PID 1108 LCN 1 visible	SID 1200 S_name Test12 S_type 0x01 PMT PID 1200 V PID 1209 A PID 1208 LCN 2 visible		Can be chosen depending of the distribution media.
<b>MUX2</b> TS_id 2 Network_id 2 ON_id <sup>1)</sup>	SID 2100 S_name Test21 S_type 0x01 PMT PID 2100 V PID 2109 A PID 2108 LCN 3 visible	SID 2200 S_name Test22 S_type 0x01 PMT PID 2200 V PID 2209 A PID 2208 LCN 4 visible	Bouquet SI All information in EIT a/o sch.	Can be chosen depending of the distribution media. Not same as for Exciter 1

<sup>1)</sup> ON\_id (Original\_network\_id) can be chosen in range 0x0001-0xfe00 (operational network) and it shall be same for both muxes

<sup>2)</sup> Network\_id for DVB-C and DVB-S/S2 IRD tests shall be same in all muxes

On MUX1 in NIT\_actual first loop configure linkage\_type 0x04 to point to MUX2. On MUX2 configure complete transport stream/bouquet SI. In linkage\_descriptor the service\_id shall be 0x0000.

**Test procedure:**

1. Turn on receiver.
2. Do re-initialization or make sure there are no services in channel list or in ESG.
3. Do channel search.
4. Check in channel list or ESG that there are services available.
5. Press the Guide button.
6. Check that the EIT information is displayed correctly as signalled for 8 days (current day + 7 full days – 24 hours) in EIT schedule.
7. Verify that extended amount (more than 8 days) of EIT data do not cause problems with the receiver
8. Verify that the EIT p/f has priority over EIT schedule in navigator (in case if the EIT p/f and EIT schedule has a conflict in EIT information)

**Expected result:**

Linkage to transport stream/bouquet information is displayed correctly as signalled in EIT schedule for following descriptors:

- Short\_event\_descriptor
- Component\_descriptor



	Extend_event_descriptor Parental_rating_descriptor						
<b>Test result(s)</b>	<table border="1"> <tr> <td></td> <td><b>NOK OR OK</b></td> </tr> <tr> <td>The services and events can be presented to viewer.</td> <td></td> </tr> <tr> <td>EIT information is available for all services and event and it is visible to viewer.</td> <td></td> </tr> </table>		<b>NOK OR OK</b>	The services and events can be presented to viewer.		EIT information is available for all services and event and it is visible to viewer.	
	<b>NOK OR OK</b>						
The services and events can be presented to viewer.							
EIT information is available for all services and event and it is visible to viewer.							
<b>Conformity</b>	<input type="checkbox"/> <b>OK Fault</b> <input type="checkbox"/> Major <input type="checkbox"/> Minor, define fail reason in comments						
<b>Comments</b>	If possible describe if fault can be fixed with software update: <input type="checkbox"/> <b>YES</b> <input type="checkbox"/> <b>NO</b> Describe more specific faults and/or other information						
<b>Date</b>	<b>Sign</b>						

<b>Test Case</b>	<b>Task 13:23 Dynamic update of EIT actual/other p/f and schedule in ESG</b>
<b>Section</b>	NorDig Unified 13.3.1 and 13.3.2
<b>Requirement</b>	<p>The ESG shall include the EIT present/following table.</p> <p>The NorDig IRD shall be able to handle situations when the EIT is not present.</p> <p>The ESG shall be non-discriminatory and display all services on equal basis.</p> <p>The ESG shall process and display the relevant content of the following tables (including start time, end time/duration, and content of all descriptors specified below</p> <p>If information is missing (i.e. not included in the transmission) the ESG shall <u>not</u> display an error message, instead the text information field shall stay empty (i.e. no information like “no information available”).</p> <p>Short_event_desc Extended_event_desc Component_desc Content_desc Parental_rating_desc CA_identifier_descriptor (optional)</p>
<b>IRD Profile(s)</b>	Basic, IRD, FE
<b>Test procedure</b>	<p><b>Purpose of test:</b> To verify the dynamic update of EIT actual/other p/f and schedule information in ESG when EIT information is signaled complete per multiplex, with other words, without using the linkage_descriptor 0x04 (“Transport Stream containing complete network/bouquet SI”) in NIT.</p> <p>The verify the handling of the EIT schedule descriptors in NorDig Basic receiver: Short_event_descriptor Component_descriptor Extend_event_descriptor Parental_rating_descriptor</p> <p><b>Equipment:</b></p>

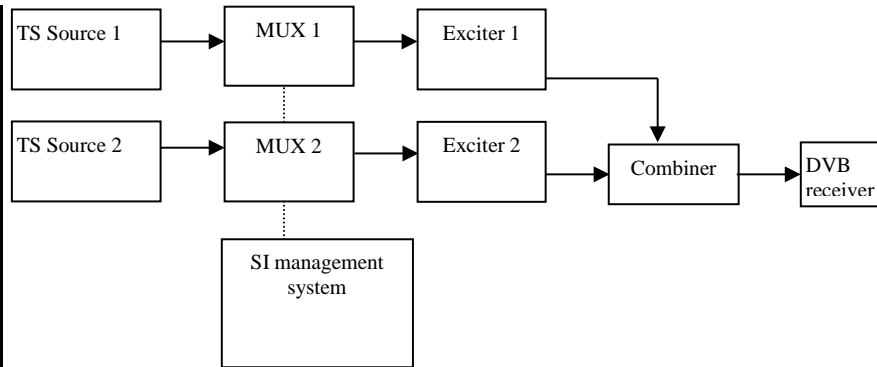

	Service1	Service2	Frequency
<b>MUX1</b> TS_id 1 Network_id 1 ON_id <sup>1)</sup>	SID 1100 S_name Test11 S_type 0x01 PMT PID 1100 V PID 1109 A PID 1108 LCN 1 visible	SID 1200 S_name Test12 S_type 0x01 PMT PID 1200 V PID 1209 A PID 1208 LCN 2 visible	Can be chosen depending of the distribution media.
<b>MUX2</b> TS_id 2 Network_id 2 ON_id <sup>1)</sup>	SID 2100 S_name Test21 S_type 0x01 PMT PID 2100 V PID 2109 A PID 2108 LCN 3 visible	SID 2200 S_name Test22 S_type 0x01 PMT PID 2200 V PID 2209 A PID 2208 LCN 4 visible	Can be chosen depending of the distribution media. Not same as for Exciter 1

<sup>1)</sup>ON\_id (Original\_network\_id) can be chosen in range 0x0001-0xfe00 (operational network) and it shall be same for both muxes

<sup>2)</sup>Network\_id for DVB-C and DVB-S/S2 IRD tests shall be same in all muxes

MUX1 event information (EIT actual p/f and schedule) is cross-distributed to MUX2 as event information (EIT other p/f and schedule).

MUX2 event information (EIT actual p/f and schedule) is cross-distributed to MUX1 as event information (EIT other p/f and schedule).

**Test procedure:**

1. Turn on receiver.
2. Do re-initialization or make sure there are no services in channel list or in ESG.
3. Do channel search.
4. Check in channel list or ESG that there are services available.
5. Press the Guide or ESG button.
6. Check that the EIT information is displayed correctly as signalled for 8 days (current day + 7 full days – 24 hours) in EIT schedule.
7. Verify that extended amount (more than 8 days) of EIT data do not cause problems with the receiver
8. Verify that the EIT p/f has priority over EIT schedule in navigator (in case if the EIT p/f and EIT schedule has a conflict in EIT information)
- 9.

**Expected result:**

EIT information is displayed correctly as signalled in EIT actual/other p/f and schedule for following descriptors:

- Short\_event\_descriptor
- Component\_descriptor
- Extend\_event\_descriptor



	Parental_rating_descriptor						
<b>Test result(s)</b>	<table border="1"> <tr> <td></td> <td><b>NOK OR OK</b></td> </tr> <tr> <td>The services and events can be presented to viewer.</td> <td></td> </tr> <tr> <td>EIT information is cross-distributed and it is visible to viewer. (MUX1 EIT information can be seen when receiver is tuned to a service on MUX2. Also the MUX2 EIT information can be seen when receiver is tuned to a service on MUX1).</td> <td></td> </tr> </table>		<b>NOK OR OK</b>	The services and events can be presented to viewer.		EIT information is cross-distributed and it is visible to viewer. (MUX1 EIT information can be seen when receiver is tuned to a service on MUX2. Also the MUX2 EIT information can be seen when receiver is tuned to a service on MUX1).	
		<b>NOK OR OK</b>					
The services and events can be presented to viewer.							
EIT information is cross-distributed and it is visible to viewer. (MUX1 EIT information can be seen when receiver is tuned to a service on MUX2. Also the MUX2 EIT information can be seen when receiver is tuned to a service on MUX1).							
<b>Conformity</b>	<input type="checkbox"/> <b>OK Fault</b> <input type="checkbox"/> Major <input type="checkbox"/> Minor, define fail reason in comments						
<b>Comments</b>	If possible describe if fault can be fixed with software update: <input type="checkbox"/> <b>YES</b> <input type="checkbox"/> <b>NO</b> Describe more specific faults and/or other information						
<b>Date</b>	<b>Sign</b>						

<b>Test Case</b>	<b>Task 13:24 PMT Descriptors - General</b>
<b>Section</b>	NorDig Unified 12.6.2
<b>Requirement</b>	<p>The following descriptors are used in PMT:</p> <p>Video_stream_descriptor  CA_descriptor  ISO_639_language_descriptor  Private_data_indicator_descriptor  Stream_identifier_descriptor  Teletext_descriptor  Subtitling_descriptor  Private_data_specifier_descriptor</p> <p>Audio_stream_descriptor (optional)  Target_background_descritor (optional)  Video_window_descritor (optional)</p>
<b>IRD Profile(s)</b>	Basic, IRD, FE
<b>Test procedure</b>	<p><b>Purpose of test:</b></p> <p>To check the support for the following descriptors:</p> <p>Video_stream_descriptor  CA_descriptor  ISO_639_language_descriptor  Private_data_indicator_descriptor  Stream_identifier_descriptor  Private_data_specifier_descriptor</p> <p><b>Equipment:</b></p>



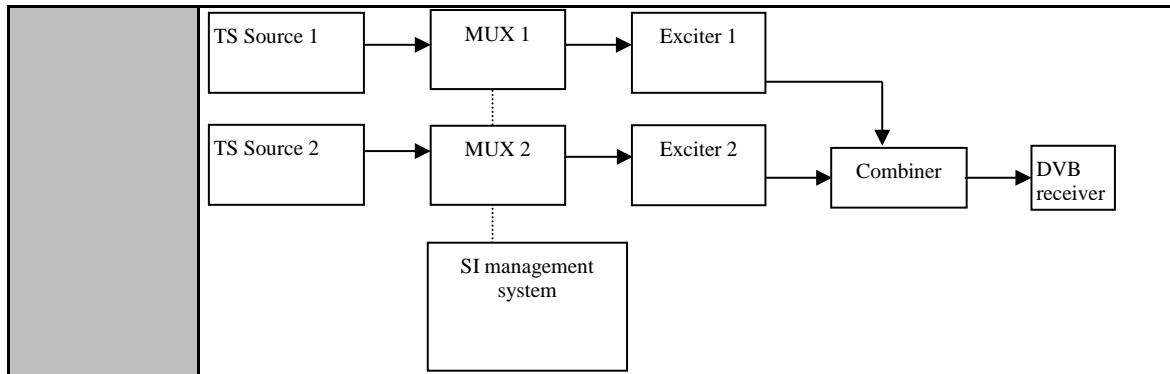

	Service1	Service2		Frequency
<b>MUX1</b> TS_id 1 Network_id 1 ON_id <sup>1)</sup>	SID 1100 S_name Test11 S_type 0x01 PMT PID 1100 V PID 1109 A PID 1108 LCN 1 visible	SID 1200 S_name Test12 S_type 0x01 PMT PID 1200 V PID 1209 A PID 1208 LCN 2 visible		Can be chosen depending of the distribution media
<b>MUX2</b> TS_id 2 Network_id 2 ON_id <sup>1)</sup>	SID 2100 S_name Test21 S_type 0x01 PMT PID 2100 V PID 2109 A PID 2108 LCN 3 visible	SID 2200 S_name Test22 S_type 0x01 PMT PID 2200 V PID 2209 A PID 2208 LCN 4 visible		Can be chosen depending of the distribution media, but cannot be same as in MUX1

<sup>1)</sup>ON\_id (Original\_network\_id) can be chosen in range 0x0001-0xfe00 (operational network) and it shall be same for both muxes

<sup>2)</sup>Network\_id for DVB-C and DVB-S/S2 IRD tests shall be same in all muxes

**Test procedure:**

1. Control that the MUX1 has a service with descriptors signalled above
2. Zap to this service and check quickly that it works.

**Expected result:**

All components in the service are able to decode.

<b>Test result(s)</b>	
<b>Conformity</b>	<input type="checkbox"/> OK <input type="checkbox"/> Fault <input type="checkbox"/> Major <input type="checkbox"/> Minor, define fail reason in comments
<b>Comments</b>	If possible describe if fault can be fixed with software update: <input type="checkbox"/> YES <input type="checkbox"/> NO Describe more specific faults and/or other information
<b>Date</b>	<b>Sign</b>

<b>Test Case</b>	<b>Task 13:25 PMT Descriptors – teletext pages, teletext subtitling and DVB subtitling</b>
<b>Section</b>	NorDig Unified 12.6.2
<b>Requirement</b>	The following descriptors are used in PMT: teletext_descriptor subtitling_descriptor
<b>IRD Profile(s)</b>	Basic, IRD, FE

<b>Test procedure</b>	<b>This requirement is tested in Test Task 8</b>
-----------------------	--------------------------------------------------

<b>Test Case</b>	<b>Task 13:26 Dynamic update of PMT PID values</b>
------------------	----------------------------------------------------

<b>Section</b>	NorDig Unified 12.1
----------------	---------------------

<b>Requirement</b>	The NorDig IRD shall at least start action for any changes in the received "dynamic" PSI and SI data, (PMT, EIT, TDT/TOT, running status and CA mode) within 1 second. (As a guideline for the implementation, the trigger for changes in received tables can be based on comparing the 'version id' in the tables)
--------------------	---------------------------------------------------------------------------------------------------------------------------------------------------------------------------------------------------------------------------------------------------------------------------------------------------------------------

<b>IRD Profile(s)</b>	Basic, IRD, FE
-----------------------	----------------

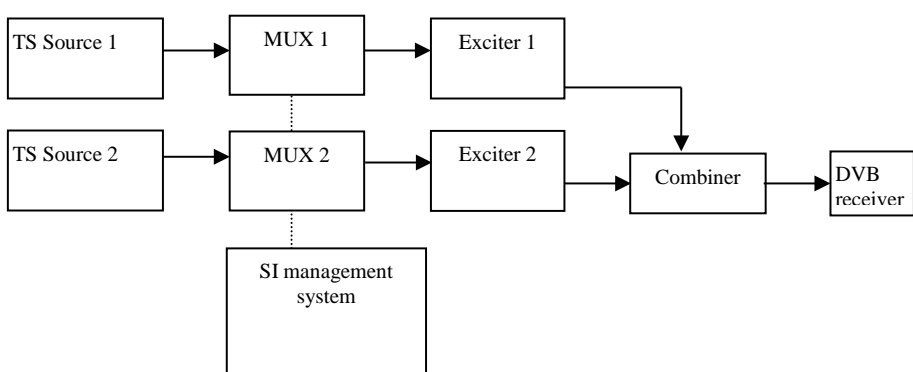
<b>Test procedure</b>	<p><b>Purpose of test:</b> To verify that the receiver is able to maintain reception when PID values in PMT are dropped, added or changed.</p> <p><b>Equipment:</b></p>  <table border="1" data-bbox="383 1209 1332 1467"> <thead> <tr> <th></th> <th>Service1</th> <th>Service2</th> <th></th> <th>Frequency</th> </tr> </thead> <tbody> <tr> <td><b>MUX1</b></td> <td>SID 1100</td> <td>SID 1200</td> <td></td> <td rowspan="7">Can be chosen depending of the distribution media</td> </tr> <tr> <td>TS_id 1</td> <td>S_name Test11</td> <td>S_name Test12</td> <td></td> </tr> <tr> <td>Network_id 1</td> <td>S_type 0x01</td> <td>S_type 0x01</td> <td></td> </tr> <tr> <td>ON_id<sup>1)</sup></td> <td>PMT PID 1100</td> <td>PMT PID 1200</td> <td></td> </tr> <tr> <td></td> <td>V PID 1109 incl PCR</td> <td>V PID 1209 incl PCR</td> <td></td> </tr> <tr> <td></td> <td>A PID 1108</td> <td>A PID 1208</td> <td></td> </tr> <tr> <td></td> <td>Teletext PID 1107</td> <td>Teletext PID 1207</td> <td></td> </tr> <tr> <td></td> <td>DVB Subt PID 1106</td> <td>DVB Subt PID 1106</td> <td></td> </tr> <tr> <td></td> <td>LCN1 visible</td> <td>LCN 2 visible</td> <td></td> <td></td> </tr> </tbody> </table> <p><sup>1)</sup>ON_id (Original_network_id) can be chosen in range 0x0001-0xfe00 (operational network)</p> <p>Sometimes broadcaster may drop, add or change the content of the PID. If this happens, the PMT is updated by changing the version_id.</p> <p><b>Test procedure:</b></p> <ol style="list-style-type: none"> <li>1. Control that the MUX1 and MUX2 have services signaled as defined in table above</li> <li>2. Zap all the services and check quickly that they work.</li> <li>3. Drop all PIDs on Service1 on MUX1.</li> <li>4. Zap to service1 in MUX1</li> <li>5. Add PIDs in following order:             <ol style="list-style-type: none"> <li>a. Video PID 1109</li> <li>b. Audio PID 1108</li> <li>c. Teletext PID1107</li> <li>d. DVB subtitling PID 1106</li> </ol> </li> <li>6. Verify that the service is decoded correctly by watching the video, listening the audio and reading the teletext, teletext subtitling and DVB subtitling</li> </ol>					Service1	Service2		Frequency	<b>MUX1</b>	SID 1100	SID 1200		Can be chosen depending of the distribution media	TS_id 1	S_name Test11	S_name Test12		Network_id 1	S_type 0x01	S_type 0x01		ON_id <sup>1)</sup>	PMT PID 1100	PMT PID 1200			V PID 1109 incl PCR	V PID 1209 incl PCR			A PID 1108	A PID 1208			Teletext PID 1107	Teletext PID 1207			DVB Subt PID 1106	DVB Subt PID 1106			LCN1 visible	LCN 2 visible		
	Service1	Service2		Frequency																																											
<b>MUX1</b>	SID 1100	SID 1200		Can be chosen depending of the distribution media																																											
TS_id 1	S_name Test11	S_name Test12																																													
Network_id 1	S_type 0x01	S_type 0x01																																													
ON_id <sup>1)</sup>	PMT PID 1100	PMT PID 1200																																													
	V PID 1109 incl PCR	V PID 1209 incl PCR																																													
	A PID 1108	A PID 1208																																													
	Teletext PID 1107	Teletext PID 1207																																													
	DVB Subt PID 1106	DVB Subt PID 1106																																													
	LCN1 visible	LCN 2 visible																																													

	<p>7. Change the following PID values:</p> <ol style="list-style-type: none"> <li>a. Video PID 1109 to 1103</li> <li>b. Audio PID 1108 to 1102</li> </ol> <p><b>Expected result:</b> After addition of the PIDs, all the component in the service are decoded correctly.</p> <p>Change of PID values maintains the service decoding.</p>	
<b>Test result(s)</b>		
<b>Conformity</b>	<input type="checkbox"/> <b>OK Fault</b> <input type="checkbox"/> Major <input type="checkbox"/> Minor, define fail reason in comments	
<b>Comments</b>	<p>If possible describe if fault can be fixed with software update: <input type="checkbox"/> <b>YES</b> <input type="checkbox"/> <b>NO</b></p> <p>Describe more specific faults and/or other information</p>	
<b>Date</b>		<b>Sign</b>

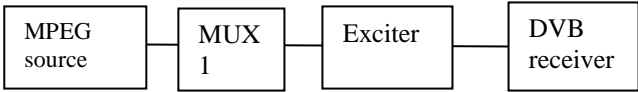
<b>Test Case</b>	<b>Task 13:27 Dynamic update of PMT-Component priority (stream type)</b>	
<b>Section</b>	NorDig Unified 12.6.3	
<b>Requirement</b>	<p>NorDig IRDs shall ignore advanced audio streams when it does not support such decoding those streams.</p> <p>For example, an IRD that do not include any AC-3 (down-mix) decoder, (maybe only supports pass-through of AC-3 to the digital audio output), shall not choose the AC-3 audio stream as default. Instead it shall choose among the IRDs supported audio stream types according to chapter 6.5, Audio prioritising.</p> <p>For video decoding, NorDig IRDs shall select the service's video components, and set the default setting in accordance with the priority list in Table 6.1.</p>	
<b>IRD Profile(s)</b>	Basic, IRD, FE	
<b>Test procedure</b>	<p><b>Purpose of test:</b> To verify that the receiver is able select video and audio components in priority order.</p> <p><b>Equipment:</b></p> <div style="text-align: center;">  <pre> graph LR     A[MPEG source] --- B[MUX 1]     B --- C[Exciter]     C --- D[DVB receiver]           </pre> </div> <p>The idea in this test is that there is always video and audio available in the receiver output or IDTV's integrated display / speakers independently which input video and audio format(s) is(are) available in the service.</p> <p>Depending of the audio selection settings (stereo or multichannel) in receiver menu system receiver shall output always audio in the correct format in the physical audio output or IDTV's integrated speakers..</p> <p>MPEG source must have capability to simultaneously with</p> <p>* video component broadcast for following video formats:</p> <ul style="list-style-type: none"> <li>• MPEG-2 MP@ML (SD)</li> </ul>	

- MPEG-4 AVC HP@L4 (HD)
- MPEG-4 AVC HP@L4 / L3 (SD)

\* audio component broadcast for following audio formats:

- MPEG-1 Layer II
- MPEG-4 HE AAC
- AC-3
- E-AC-3

	Service1	Service2	Frequency
<b>MUX1</b>	SID 1100	SID 1200	Can be chosen depending of the distribution media
TS_id 1	S_name Test11	S_name Test12	
Network_id 1	PMT PID 1100	PMT PID 1200	
ON_id <sup>1)</sup>	V PID 1109 (MPEG 2 SD)	V PID 1209 incl PCR	
	V PID 1119 (AVC HD)	A PID 1208	
	V PID 1129 (AVC SD)	Teletext PID 1207	
	A PID 1108 (MPEG1 L2)	DVB Subt PID 1106	
	A PID 1118 (HE AAC)	Logical_chan_desc 2 visible	
	A PID 1128 (E-AC-3)		
	A PID 1138 (AC-3)		
	Logical_chan_desc 1 visible		

<sup>1)</sup>ON\_id (Original\_network\_id) can be chosen in range 0x0001-0xfe00 (operational network)

The service PCR is broadcasted in separate PID.

**Test procedure:**

1. Control that the MUX1 have services signaled as defined in table above
2. Zap all the services and check quickly that they works.
3. Zap to service1 in MUX1
4. Drop PIDs in following order:
  - a. Video PID 1119
  - b. Video PID 1129
  - c. Audio PID 1118
  - d. Audio PID 1128
  - e. Audio PID 1138
5. Add PIDs in following order:
  - a. Video PID 1129
  - b. Video PID 1119
  - c. Audio PID 1138
  - d. Audio PID 1128
  - e. Audio PID 1118
6. Verify that the service is decoded correctly by watching the video, listening the audio

**Expected result:**

HDTV receiver: After remove and addition of the PIDs, all the component in the service are decoded correctly.

SDTV receiver: stream\_types not supported by the receiver are not affecting the receiver operability.

**Test result(s)**

Video codecs:

	Video codec	Stream_type	Priority	OK/NOK
	MPEG-4 AVC HP@L4 HD video stream	0x1B	1 (highest)	
	MPEG-4 AVC HP@L4 / L3 SD video stream	0x1B	2	
	Basic, MPEG-2 MP@ML video stream (or MPEG1)	0x02 (0x01)	3 (lowest)	
	Audio codecs:			
	Audio codec	Stream_type	Priority	OK/NOK
	MPEG-4 HE.AAC (or LC.AAC) v2 audio stream	0x11	1 (highest)	
	E-AC-3 (Enhanced AC-3) audio stream	0x06	2	
	AC-3 (AC-3) audio stream	0x06	3	
	Basic, MPEG-1 Layer II audio stream	0x03	4 (lowest)	
Conformity	<input type="checkbox"/> <b>OK Fault</b> <input type="checkbox"/> Major <input type="checkbox"/> Minor, define fail reason in comments			
Comments	If possible describe if fault can be fixed with software update: <input type="checkbox"/> <b>YES</b> <input type="checkbox"/> <b>NO</b> Describe more specific faults and/or other information			
Date		Sign		

Test Case	<b>Task 13:28 Dynamic update of PMT - Content_Protection_descriptor</b>
Section	NorDig Unified 12.6.7
Requirement	This descriptor is used to signal the content protection level for the received service, see Table 12.29. The IRD shall use the signalled Content Protection level together with the IRD's HDCP user setting to determine if HDCP shall be enabled or disabled on the HDMI output interface, see section 8.6.4. The Content Protection descriptor shall be conveyed in the descriptor loop immediately following the program_info_length field in the Program Map Table. The descriptor only applies to the service to which the program map table is applicable. If the descriptor is missing for a service, it shall be interpreted as content protection level 0x01 (see Table 12.29).
IRD Profile(s)	Basic, IRD, FE
Test procedure	<b>This requirement is tested in TestTask 9:7</b>

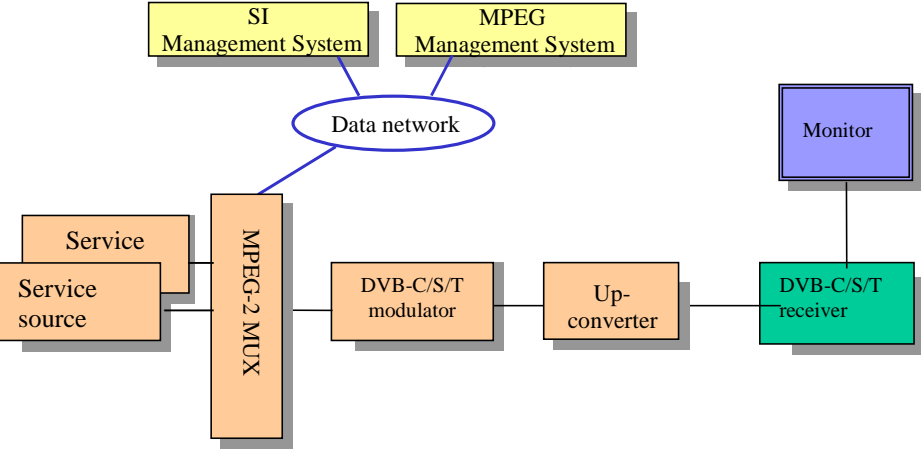
<b>Test Case</b>	<b>Task 13:29 Dynamic update of TDT/TOT</b>
<b>Section</b>	NorDig Unified 12.5
<b>Requirement</b>	The NorDig IRD shall have a real time clock and time/date (calendar) running continuously. The time/date (calendar) shall be updated by incoming TDT and TOT from SI. NorDig IRD shall display the correct time for each country based on TDT, TOT, and the country name selected by the user.
<b>IRD Profile(s)</b>	Basic, IRD, FE
<b>Test procedure</b>	<p><b>Purpose of test:</b> To verify that the real time clock runs continuously.</p> <p><b>Equipment:</b></p>  <p><b>Test procedure for continuously running clock / calendar:</b></p> <ol style="list-style-type: none"> <li>1. Connect and start up the instruments</li> <li>2. Make sure that the TDT (Time and Date Table) and TOT (Time Offset Table) are present in the transport stream.</li> <li>3. Locate the time and date display.</li> <li>4. Check if the time and date is updated and fill in the test protocol. (Date can be tested separately and filled later in the test protocol).</li> </ol> <p><b>Expected result:</b> The time and date shall be displayed and updated in the navigator as time goes by.</p> <p><b>Purpose of test:</b> To test that the real time clock is updated from TDT and TOT information.</p> <p><b>Equipment:</b> As in previous test.</p> <p>Example of the configuration of the local_time_offset descriptor in the TOT for Sweden and from summertime to wintertime change. Date of the change is 28/10/2001 and time 01:00:00 o'clock.</p>

	<table border="1" data-bbox="387 248 1217 515"> <tr> <td><i>Descriptor tag</i></td> <td></td> <td><i>0x58</i></td> </tr> <tr> <td><i>Descriptor length</i></td> <td></td> <td></td> </tr> <tr> <td><i>Country code</i></td> <td><i>SWE</i></td> <td><i>0x535745</i></td> </tr> <tr> <td><i>Country region id</i></td> <td><i>Only one time zone</i></td> <td><i>00 00 00 (bin)</i></td> </tr> <tr> <td><i>Reserved</i></td> <td></td> <td><i>0 (bin)</i></td> </tr> <tr> <td><i>Local time offset polarity</i></td> <td><i>the polarity is positive</i></td> <td><i>0 (bin)</i></td> </tr> <tr> <td><i>Local time offset</i></td> <td><i>2 h in Sweden on summertime</i></td> <td><i>0x0200</i></td> </tr> <tr> <td><i>Time of change</i></td> <td><i>28/10/2001 01:00:00</i></td> <td><i>0xCBf2010000</i></td> </tr> <tr> <td><i>Next time offset</i></td> <td><i>01:00:00</i></td> <td><i>0x0100</i></td> </tr> </table> <p><b>Test procedure Updated clock by TDT and TOT:</b></p> <p>(Use traditional calendar to find out dates and times for the next wintertime and summertime changes.)</p> <ol style="list-style-type: none"> <li>1. Connect and start up the instruments</li> <li>2. Make sure that the TDT (Time and Date Table) and TOT (Time Offset Table) is present in the transport stream.</li> <li>3. Configure the TOT without local_time_offset decriptor. Configure the TDT in the transport stream as it is specified in the test protocol.</li> <li>4. Turn on receiver.</li> <li>5. Wait for the change of the year.</li> <li>6. Locate the time and date display.</li> <li>7. Check the time and date in the navigator.</li> <li>8. Fill in the result and NOK or OK in the test protocol.</li> <li>9. Turn off receiver.</li> <li>10. Configure TOT local_time_offset descriptor for the next change to wintertime/summertime. Set UTC_time in the TDT few minutes before actual change. Make sure the same UTC_time is used in TOT.</li> <li>11. Turn on receiver.</li> <li>12. Check the time and date in the navigator.</li> <li>13. Fill in the test date and time, result date and time and NOK or OK in the protocol.</li> <li>14. Turn off receiver.</li> <li>15. Configure TOT local_time_offset descriptor for the next change to summertime/wintertime after the date used in test point 10. Set UTC_time in the TDT few minutes before that change. Make sure the same UTC_time is used in TOT.</li> <li>16. Turn on receiver.</li> <li>17. Check the time and date in the navigator.</li> <li>18. Fill in the test date and time, result date and time and NOK or OK in the protocol.</li> <li>19. Repeat test points 14 to 18 using country codes for ICE (Iceland), DNK (Denmark), FIN (Finland) and NOR (Norway).</li> </ol> <p><b>Expected result:</b> All test results fulfills the expected results as defined in the specification.</p>	<i>Descriptor tag</i>		<i>0x58</i>	<i>Descriptor length</i>			<i>Country code</i>	<i>SWE</i>	<i>0x535745</i>	<i>Country region id</i>	<i>Only one time zone</i>	<i>00 00 00 (bin)</i>	<i>Reserved</i>		<i>0 (bin)</i>	<i>Local time offset polarity</i>	<i>the polarity is positive</i>	<i>0 (bin)</i>	<i>Local time offset</i>	<i>2 h in Sweden on summertime</i>	<i>0x0200</i>	<i>Time of change</i>	<i>28/10/2001 01:00:00</i>	<i>0xCBf2010000</i>	<i>Next time offset</i>	<i>01:00:00</i>	<i>0x0100</i>
<i>Descriptor tag</i>		<i>0x58</i>																										
<i>Descriptor length</i>																												
<i>Country code</i>	<i>SWE</i>	<i>0x535745</i>																										
<i>Country region id</i>	<i>Only one time zone</i>	<i>00 00 00 (bin)</i>																										
<i>Reserved</i>		<i>0 (bin)</i>																										
<i>Local time offset polarity</i>	<i>the polarity is positive</i>	<i>0 (bin)</i>																										
<i>Local time offset</i>	<i>2 h in Sweden on summertime</i>	<i>0x0200</i>																										
<i>Time of change</i>	<i>28/10/2001 01:00:00</i>	<i>0xCBf2010000</i>																										
<i>Next time offset</i>	<i>01:00:00</i>	<i>0x0100</i>																										
<p><i>Test result(s)</i></p>	<p><b>Test procedure for continuously running clock / calendar :</b></p> <table border="1" data-bbox="387 1776 1235 1906"> <thead> <tr> <th><b>Expected result, time</b></th> <th><b>Expected result, date</b></th> <th><b>NOK or OK, time</b></th> <th><b>NOK or OK, date</b></th> </tr> </thead> <tbody> <tr> <td>Time is changed.</td> <td>Date is changed.</td> <td></td> <td></td> </tr> </tbody> </table> <p><b>Test procedure Updated clock by TDT and TOT:</b> Test points 1-8. (TDT test)</p>	<b>Expected result, time</b>	<b>Expected result, date</b>	<b>NOK or OK, time</b>	<b>NOK or OK, date</b>	Time is changed.	Date is changed.																					
<b>Expected result, time</b>	<b>Expected result, date</b>	<b>NOK or OK, time</b>	<b>NOK or OK, date</b>																									
Time is changed.	Date is changed.																											

Test date and time		Date and time in MJD+UTC (BCD) format (required in the TDT)			
2001-12-31 23:57:00		0xCC32235700			

Result, time	Result, date	Expected result, time	Expected result, date	NOK or OK, time	NOK or OK, date
		The time ≈ 23:57 is presented in a comprehensive format	The date 2001-12-31 is presented in a comprehensive format		
		The time ≈ 00:01 is presented in a comprehensive format	The date 2002-01-01 is presented in a comprehensive format		

Test points 9-13. (TOT test)

Test, time	Test, date	Expected result, time	Expected result, date	NOK or OK, time	NOK or OK, date
		Time before change.	Date before change.		
		Time after change.	Time before change.		

Test points 14-19. (TOT test)



Test, time	Test, date	Expected result, time	Expected result, date	Country code	NOK or OK, time	NOK or OK, date
		Time before change.	Date before change.	SWE		
		Time after change.	Time before change.	SWE		
		Time before change.	Date before change.	ICE		
		Time after change.	Time before change.	ICE		
		Time before change.	Date before change.	DNK		
		Time after change.	Time before change.	DNK		
		Time before change.	Date before change.	FIN		
		Time after change.	Time before change.	FIN		
		Time before change.	Date before change.	NOR		
		Time after change.	Time before change.	NOR		
<b>Conformity</b>	<input type="checkbox"/> <b>OK Fault</b> <input type="checkbox"/> Major <input type="checkbox"/> Minor, define fail reason in comments					
<b>Comments</b>	If possible describe if fault can be fixed with software update: <input type="checkbox"/> <b>YES</b> <input type="checkbox"/> <b>NO</b> Describe more specific faults and/or other information					
<b>Date</b>				<b>Sign</b>		

## 2.14 Task 14: Navigator

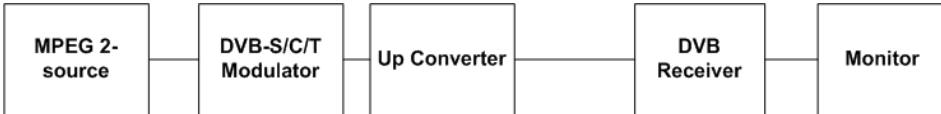
<b>Test Case</b>	<b>Task 14:1 Navigator: General</b>	
<b>Section</b>	NorDig Unified 13.1 and 16	
<b>Requirement</b>	<p>The NorDig IRD shall implement a basic Navigator, which provides user access to system information, and allows the user to control the operation of the IRD. The Navigator is by definition part of the system software.</p> <p>The Navigator shall include a service list function and a basic Event Schedule Guide.</p> <p>The Navigator shall also initiate bootloading</p> <p>The Navigator shall support the Nordic and English languages.</p>	
<b>IRD Profile(s)</b>	Basic, IRD, FE	
<b>Test procedure</b>	<p><b>Purpose of test:</b> To test the existents of the Navigator functions.</p> <p>Initiating of bootloading in Navigator is tested in test taskTask 6:1.</p> <p><b>Equipment:</b></p> <div style="text-align: center;">  <pre> graph LR     A[MPEG 2-source] --- B[DVB-S/C/T Modulator]     B --- C[Up Converter]     C --- D[DVB Receiver]     D --- E[Monitor] </pre> </div> <p><b>Test procedure:</b></p> <ol style="list-style-type: none"> <li>1. Start the Navigator.</li> <li>2. Check that it displays the valid services and allow control of the IRD.</li> <li>3. Check that a service list is presented and that EIT p/f is displayed.</li> <li>4. Verify navigator supports Nordic and English languages.</li> <li>5. Verify that navigator has user setting for the preferences</li> </ol> <p><b>Expected result:</b></p> <p>The Navigator is present and complies with the requirement defined above.</p> <p>Verify initiating of bootloading is tested in Task 6.1.</p>	
<b>Test result(s)</b>		
<b>Conformity</b>	<input type="checkbox"/> <b>OK Fault</b> <input type="checkbox"/> Major <input type="checkbox"/> Minor, define fail reason in comments	
<b>Comments</b>	<p>If possible describe if fault can be fixed with software update: <input type="checkbox"/> <b>YES</b> <input type="checkbox"/> <b>NO</b></p> <p>Describe more specific faults and/or other information</p>	
<b>Date</b>		<b>Sign</b>

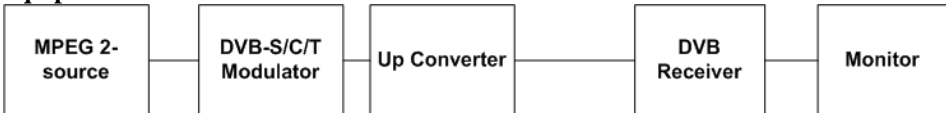

<b>Test Case</b>	<b>Task 14:2 Service list - General requirement</b>	
<b>Section</b>	NorDig Unified 13.2.1	
<b>Requirement</b>	The service list shall be displayed to the user. The user shall be able to select a service from the displayed service list. The selected service shall appear immediately	
<b>IRD Profile(s)</b>	Basic, IRD, FE	
<b>Test procedure</b>	<p><b>Purpose of test:</b> To verify that the service list contains services and they are accessible.</p> <p><b>Equipment:</b></p>  <pre> graph LR     A[MPEG 2-source] --- B[DVB-S/C/T Modulator]     B --- C[Up Converter]     C --- D[DVB Receiver]     D --- E[Monitor]             </pre> <p><b>Test procedure:</b> Start the Navigator and go through and select all services in the list in a random pattern.</p> <p><b>Expected result:</b> Verify that all services are accessible.</p>	
<b>Test result(s)</b>		
<b>Conformity</b>	<input type="checkbox"/> OK Fault <input type="checkbox"/> Major <input type="checkbox"/> Minor, define fail reason in comments	
<b>Comments</b>	If possible describe if fault can be fixed with software update: <input type="checkbox"/> YES <input type="checkbox"/> NO Describe more specific faults and/or other information	
<b>Date</b>		<b>Sign</b>

<b>Test Case</b>	<b>Task 14:3 Service list – service types and categories</b>	
<b>Section</b>	NorDig Unified 12.1.4 and 12.1.5 and 13.2.1.1	
<b>Requirement</b>	<p>The NorDig IRD shall minimum handle the service types listed in Table 12.1.</p> <p>Service types that are not supported by the NorDig IRD should be ignored. (If the (SDTV) IRD do not support MPEG-4 AVC video decoder, it should not list/install within the TV service list service types for advanced codec; 0x16 and 0x19).</p> <p>The services are group into three service type categories; TV (1), Radio (2) and Others/data (3) services:                      (1)TV category includes services with service type; 0x01 digital (MPEG-2) TV service, 0x16 advanced codec SD TV service and 0x19 advanced codec HD TV service.                      (2)Radio category includes services with service type; 0x02 digital radio sound service and 0x0A advanced codec digital radio sound service.                      (3)Others/(data) category includes all other service types that are not included in TV (1) and Radio (2) categories.</p> <p>The NorDig IRD (1) shall during installation of services create a common service list for each category (i.e. all 0x01, 0x16 and 0x19 within same TV category list and so on for the Radio and Other/data categories).</p>	

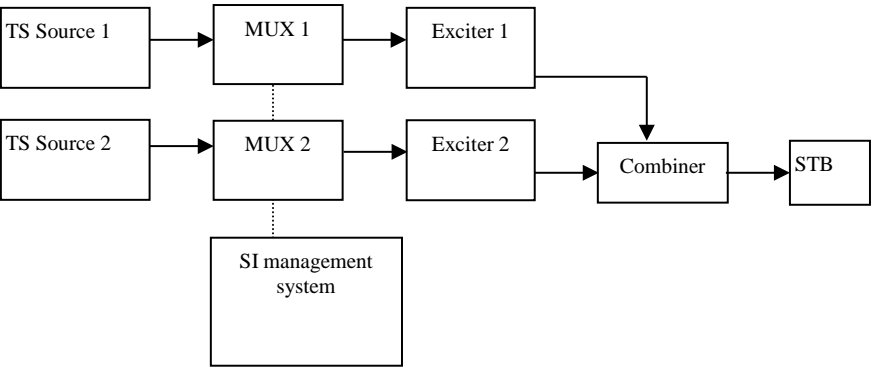
	<p>The IRD shall build up different sections inside one service list or build up several service lists, one for each different service_type as the default IRD service_list(s).</p>															
<p><b>IRD Profile(s)</b></p>	<p>Basic, IRD, FE</p>															
<p><b>Test procedure</b></p>	<p><b>Purpose of test:</b> To test that the different type of services are located on different lists.</p> <p><b>Equipment:</b></p>  <table border="1" data-bbox="406 985 1316 1444"> <thead> <tr> <th></th> <th>Service1</th> <th>Service2</th> <th>Service3</th> <th>Frequency</th> </tr> </thead> <tbody> <tr> <td><b>MUX1</b> TS_id 1 Network_id 1 ON_id <sup>1)</sup></td> <td>SID 1100 Service type 0x01 S_name Test11 PMT PID 1100 V PID 1109 A PID 1108 LCD: 1 visible Encrypted</td> <td>SID 1200 Service type 0x02 S_name Test12 PMT PID 1200  A PID 1208 LCD: 2 visible Clear</td> <td>SID 1300 Service type 0x0C S_name Test13 PMT PID 1300 V PID 1309 A PID 1308 LCD: 3 visible Clear</td> <td>Can be chosen depending of the distribution media</td> </tr> <tr> <td><b>MUX2</b> TS_id 2 Network_id 2<sup>2)</sup> ON_id <sup>1)</sup></td> <td>SID 2100 Service type 0x16 S_name Test21 PMT PID 2100 V PID 2109 A PID 2108 LCD: 4 visible Clear</td> <td>SID 2200 Service type 0x19 S_name Test22 PMT PID 2200 V PID 2209 A PID 2208 LCD: 5 visible Clear</td> <td>SID 2300 Service type 0x0A S_name Test23 PMT PID 2300  A PID 2308 LCD: 6 visible Clear</td> <td>Can be chosen depending of the distribution media</td> </tr> </tbody> </table> <p><sup>1)</sup>ON_id (Original_network_id) can be chosen in range 0x0001-0xfe00 (operational network) and it shall be same for both muxes and it shall be same for both muxes <sup>2)</sup>Network_id for DVB-C and DVB-S/S2 IRD tests shall be same in all muxes</p> <p>Channel list ID is set to 1 and country_code according to country settings in the receiver. Services in MUX1 are using MPEG-2 video and MPEG1 LII audio. Services in MUX2 are allowed only use advanced coded video and audio, with other words MPEG-4 AVC video and HE-AAC or E-AC-3 audio.</p> <p><b>Test procedure:</b></p> <ol style="list-style-type: none"> <li>1. Verify that the services on MUX1 and MUX2 have service types digital television services, digital radio service and data broadcast service according to table above.</li> <li>2. Perform re-initialisation if needed.</li> <li>3. Check the service lists.</li> </ol>		Service1	Service2	Service3	Frequency	<b>MUX1</b> TS_id 1 Network_id 1 ON_id <sup>1)</sup>	SID 1100 Service type 0x01 S_name Test11 PMT PID 1100 V PID 1109 A PID 1108 LCD: 1 visible Encrypted	SID 1200 Service type 0x02 S_name Test12 PMT PID 1200  A PID 1208 LCD: 2 visible Clear	SID 1300 Service type 0x0C S_name Test13 PMT PID 1300 V PID 1309 A PID 1308 LCD: 3 visible Clear	Can be chosen depending of the distribution media	<b>MUX2</b> TS_id 2 Network_id 2 <sup>2)</sup> ON_id <sup>1)</sup>	SID 2100 Service type 0x16 S_name Test21 PMT PID 2100 V PID 2109 A PID 2108 LCD: 4 visible Clear	SID 2200 Service type 0x19 S_name Test22 PMT PID 2200 V PID 2209 A PID 2208 LCD: 5 visible Clear	SID 2300 Service type 0x0A S_name Test23 PMT PID 2300  A PID 2308 LCD: 6 visible Clear	Can be chosen depending of the distribution media
	Service1	Service2	Service3	Frequency												
<b>MUX1</b> TS_id 1 Network_id 1 ON_id <sup>1)</sup>	SID 1100 Service type 0x01 S_name Test11 PMT PID 1100 V PID 1109 A PID 1108 LCD: 1 visible Encrypted	SID 1200 Service type 0x02 S_name Test12 PMT PID 1200  A PID 1208 LCD: 2 visible Clear	SID 1300 Service type 0x0C S_name Test13 PMT PID 1300 V PID 1309 A PID 1308 LCD: 3 visible Clear	Can be chosen depending of the distribution media												
<b>MUX2</b> TS_id 2 Network_id 2 <sup>2)</sup> ON_id <sup>1)</sup>	SID 2100 Service type 0x16 S_name Test21 PMT PID 2100 V PID 2109 A PID 2108 LCD: 4 visible Clear	SID 2200 Service type 0x19 S_name Test22 PMT PID 2200 V PID 2209 A PID 2208 LCD: 5 visible Clear	SID 2300 Service type 0x0A S_name Test23 PMT PID 2300  A PID 2308 LCD: 6 visible Clear	Can be chosen depending of the distribution media												

	<p>4. Fill in the measurement record.</p> <p><b>Expected result:</b> Different types of services are available on different category lists according to requirement.</p> <p>Categories are 'TV', 'Radio', and 'Data/Other' services.</p> <p>Optionally SDTV receiver doesn't store HDTV services.</p>																																																																			
<b>Test result(s)</b>	<p>Measurement record:</p> <table border="1" style="margin-left: auto; margin-right: auto;"> <thead> <tr> <th colspan="5">SDTV receiver</th> </tr> <tr> <th>Pos</th> <th>'TV'</th> <th>'Radio'</th> <th>'Data/Other'</th> <th>NOK or OK</th> </tr> </thead> <tbody> <tr> <td>1</td> <td>Test11</td> <td></td> <td></td> <td></td> </tr> <tr> <td>2</td> <td></td> <td>Test12</td> <td></td> <td></td> </tr> <tr> <td>3</td> <td></td> <td></td> <td>Test13</td> <td></td> </tr> </tbody> </table> <table border="1" style="margin-left: auto; margin-right: auto;"> <thead> <tr> <th colspan="5">HDTV receiver</th> </tr> <tr> <th>Pos</th> <th>'TV'</th> <th>'Radio'</th> <th>'Data/Other'</th> <th>NOK or OK</th> </tr> </thead> <tbody> <tr> <td>1</td> <td>Test11</td> <td></td> <td></td> <td></td> </tr> <tr> <td>2</td> <td></td> <td>Test12</td> <td></td> <td></td> </tr> <tr> <td>3</td> <td></td> <td></td> <td>Test13</td> <td></td> </tr> <tr> <td>4</td> <td>Test21</td> <td></td> <td></td> <td></td> </tr> <tr> <td>5</td> <td>Test22</td> <td></td> <td></td> <td></td> </tr> <tr> <td>6</td> <td></td> <td>Test23</td> <td></td> <td></td> </tr> </tbody> </table>			SDTV receiver					Pos	'TV'	'Radio'	'Data/Other'	NOK or OK	1	Test11				2		Test12			3			Test13		HDTV receiver					Pos	'TV'	'Radio'	'Data/Other'	NOK or OK	1	Test11				2		Test12			3			Test13		4	Test21				5	Test22				6		Test23		
SDTV receiver																																																																				
Pos	'TV'	'Radio'	'Data/Other'	NOK or OK																																																																
1	Test11																																																																			
2		Test12																																																																		
3			Test13																																																																	
HDTV receiver																																																																				
Pos	'TV'	'Radio'	'Data/Other'	NOK or OK																																																																
1	Test11																																																																			
2		Test12																																																																		
3			Test13																																																																	
4	Test21																																																																			
5	Test22																																																																			
6		Test23																																																																		
<b>Conformity</b>	<input type="checkbox"/> <b>OK Fault</b> <input type="checkbox"/> Major <input type="checkbox"/> Minor, define fail reason in comments																																																																			
<b>Comments</b>	<p>If possible describe if fault can be fixed with software update: <input type="checkbox"/> <b>YES</b> <input type="checkbox"/> <b>NO</b></p> <p>Describe more specific faults and/or other information</p>																																																																			
<b>Date</b>		<b>Sign</b>																																																																		

<b>Test Case</b>	<b>Task 14:4 Service list – use of NIT_other and SDT_other</b>
<b>Section</b>	NorDig Unified 13.2.2 and 13.2.3
<b>Requirement</b>	<p>The NorDig IRD shall make use of the descriptors listed in below in all NIT_actual (the transport stream the NorDig IRD is tuned to) and NIT_other (other transport stream) tables available in order to update the service list (system delivery data, number of transport streams, logic channel number etc).</p> <p>NIT descriptors:</p> <p>Network_name_descriptor          Satellite_delivery_system_descriptor          Cable_delivery_system_descriptor          Terrestrial_delivery_system_descriptor</p> <p>T2_delivery_system_descriptor          Service_list_descriptor</p> <p>(Nordig) Logical_channel_descriptor</p> <p>A Navigator shall never display services that the IRD is not able to receive or decode</p>

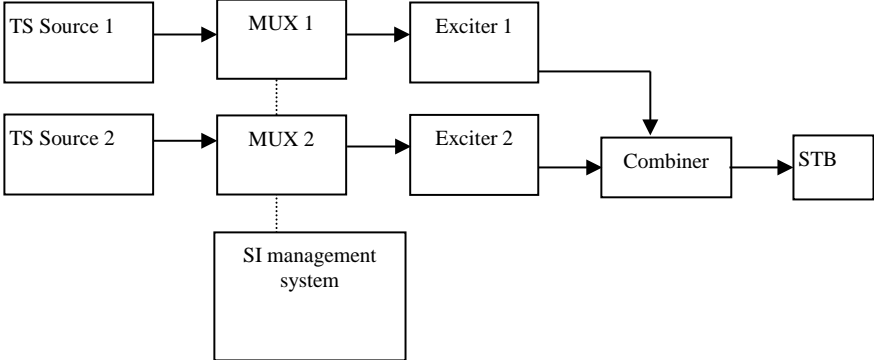
	<p>except for descrambling.</p> <p>The IRD shall use the descriptors listed in table 13.2 from both SDT_actual and SDT_other tables to update the service list (service names etc.).</p>												
<b>IRD Profile(s)</b>	Basic, IRD, FE												
<b>Test procedure</b>	<p><b>Purpose of test:</b> To verify that the services, which are not able to receive, but signaled in SDT_other and/or NIT_other, are not visible in service list.</p> <p><b>Equipment:</b></p>  <table border="1" data-bbox="387 1025 1342 1406"> <thead> <tr> <th></th> <th>Service1</th> <th>Service2</th> <th>Frequency</th> </tr> </thead> <tbody> <tr> <td><b>MUX1</b> TS_id 1 Network_id 1 ON_id <sup>1)</sup></td> <td>SID 1100 S_name Test11 PMT PID 1100 V PID 1109 A PID 1108 Logical_chan_desc 1 visible</td> <td>SID 1200 S_name Test12 PMT PID 1200 V PID 1209 A PID 1208 Logical_chan_desc 2 visible</td> <td>Can be chosen depending of the distribution media.</td> </tr> <tr> <td><b>MUX2</b> TS_id 2 Network_id 2 ON_id <sup>1)</sup></td> <td>SID 2100 S_name Test21 PMT PID 2100 V PID 2109 A PID 2108 Logical_chan_desc 3 visible</td> <td>SID 2200 S_name Test22 PMT PID 2200 V PID 2209 A PID 2208 Logical_chan_desc 4 visible</td> <td>Can be chosen depending of the distribution media. Not same as for Exciter 1</td> </tr> </tbody> </table> <p><sup>1)</sup>ON_id (Original_network_id) can be chosen in range 0x0001-0xfe00 (operational network) and it shall be same for both muxes  <sup>2)</sup>Network_id for DVB-C and DVB-S/S2 IRD tests shall be same in all muxes</p> <p>Following tables are signaled in both MUX:</p> <ul style="list-style-type: none"> <li>• SDT_actual and</li> <li>• SDT_other</li> <li>• NIT_acutal inclusive service_list</li> <li>• NIT_other inclusive service_list</li> </ul> <p>With following information content:</p> <ul style="list-style-type: none"> <li>• In MUX1, the SDT_actual corresponds the SDT_other in MUX2.</li> <li>• In MUX2, the SDT_actual corresponds the SDT_other in MUX1</li> <li>• In MUX1, the NIT_actual corresponds the NIT_other in MUX2</li> <li>• In MUX2, the NIT_acutal corresponds the NIT_other in MUX1</li> </ul> <p>With other words, the SDT and NIT information is cross-distributed between multiplexes.</p> <p><b>Test procedure:</b></p>		Service1	Service2	Frequency	<b>MUX1</b> TS_id 1 Network_id 1 ON_id <sup>1)</sup>	SID 1100 S_name Test11 PMT PID 1100 V PID 1109 A PID 1108 Logical_chan_desc 1 visible	SID 1200 S_name Test12 PMT PID 1200 V PID 1209 A PID 1208 Logical_chan_desc 2 visible	Can be chosen depending of the distribution media.	<b>MUX2</b> TS_id 2 Network_id 2 ON_id <sup>1)</sup>	SID 2100 S_name Test21 PMT PID 2100 V PID 2109 A PID 2108 Logical_chan_desc 3 visible	SID 2200 S_name Test22 PMT PID 2200 V PID 2209 A PID 2208 Logical_chan_desc 4 visible	Can be chosen depending of the distribution media. Not same as for Exciter 1
	Service1	Service2	Frequency										
<b>MUX1</b> TS_id 1 Network_id 1 ON_id <sup>1)</sup>	SID 1100 S_name Test11 PMT PID 1100 V PID 1109 A PID 1108 Logical_chan_desc 1 visible	SID 1200 S_name Test12 PMT PID 1200 V PID 1209 A PID 1208 Logical_chan_desc 2 visible	Can be chosen depending of the distribution media.										
<b>MUX2</b> TS_id 2 Network_id 2 ON_id <sup>1)</sup>	SID 2100 S_name Test21 PMT PID 2100 V PID 2109 A PID 2108 Logical_chan_desc 3 visible	SID 2200 S_name Test22 PMT PID 2200 V PID 2209 A PID 2208 Logical_chan_desc 4 visible	Can be chosen depending of the distribution media. Not same as for Exciter 1										

	<p>The idea of the test is that for stationary reception, the services from the SDT_other and NIT_other service_list_description shall not be installed in the service list if the services are not able to be received.</p> <ol style="list-style-type: none"> <li>1. Attenuate the output level of the exciter 1 to very low level or disconnect the output cable.</li> <li>2. Clear all channels on service list (channel list in receiver).</li> <li>3. Make new channel search.</li> <li>4. Verify that no services are installed carried within the transport stream through MUX1.</li> <li>5. Fill in the measurement record in test results.</li> <li>6. Increase the output level of the exciter1 to a output level that is able to be received by the receiver.</li> <li>7. Clear all channels on service list (channel list in receiver).</li> <li>8. Make new channel search.</li> <li>9. Verify that all the services carried within transport stream from both MUX1 and MUX2 are installed in the service list (channel list in receiver).</li> <li>10. Zap to service1 in MUX1.</li> </ol> <p><b>Expected result:</b> Services that are not able to be received are not available in the service list (channel list).</p>					
<i>Test result(s)</i>	<table border="1"> <thead> <tr> <th style="text-align: left;">Requirement</th> <th style="text-align: left;">NOK or OK</th> </tr> </thead> <tbody> <tr> <td>Services are not listed in service list (channel list) when the services are not able to be received</td> <td></td> </tr> </tbody> </table>		Requirement	NOK or OK	Services are not listed in service list (channel list) when the services are not able to be received	
Requirement	NOK or OK					
Services are not listed in service list (channel list) when the services are not able to be received						
<i>Conformity</i>	<input type="checkbox"/> <b>OK Fault</b> <input type="checkbox"/> Major <input type="checkbox"/> Minor, define fail reason in comments					
<i>Comments</i>	<p>If possible describe if fault can be fixed with software update: <input type="checkbox"/> <b>YES</b> <input type="checkbox"/> <b>NO</b> Describe more specific faults and/or other information</p>					
<i>Date</i>		<i>Sign</i>				

<i>Test Case</i>	<b>Task 14:5 Service list - Inconsistent of SDT_actual and NIT_actual information</b>
<i>Section</i>	NorDig Rules Of Operation 2.6.2
<i>Requirement</i>	Optional descriptors: Service_list_descriptor
<i>IRD Profile(s)</i>	Basic, IRD, FE

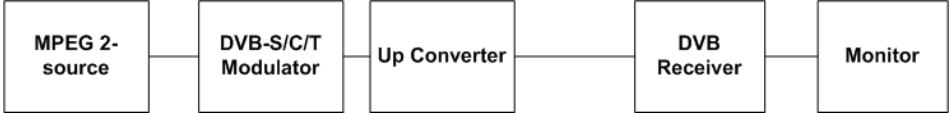
<b>Test procedure</b>	<p><b>Purpose of the test:</b> To verify if the IRD updates service list quasi-static from SDT_actual instead of NIT_actual service_list_descriptor.</p> <p><b>Equipment:</b></p> <div style="text-align: center;">  <pre> graph LR     A[MPEG 2-source] --- B[DVB-S/C/T Modulator]     B --- C[Up Converter]     C --- D[DVB Receiver]     D --- E[Monitor]             </pre> </div> <p><b>Test procedure:</b></p> <p>Service_list in NIT is optional to broadcast. Therefore, it is important to verify how the receiver extract information from the SDT_actual and NIT_actual service_list in case the information is inconsistent.</p> <p>Transport stream shall have at least one service configured. The SDT_actual signalize the service, but the service_list_descriptor in NIT_actual shall not have the service listed.</p> <p><b>Test procedure:</b></p> <ol style="list-style-type: none"> <li>1. Make first time installation of the IRD</li> <li>2. Verify the service_list_descriptor doesn't list at least one of the services carried within transport stream. With other words, there is inconsistent between SDT_actual and service_list_descriptor in NIT_actual</li> <li>3. Verify that all the carried services within transport stream are in the service list.</li> </ol> <p><b>Expected result:</b> Services, carried within transport stream and listed in SDT_actual, are listed in service list independently if the services are listed in service_list_descriptor in NIT_actual.</p>
<b>Test result(s)</b>	
<b>Conformity</b>	<input type="checkbox"/> OK <input type="checkbox"/> Fault <input type="checkbox"/> Major <input type="checkbox"/> Minor, define fail reason in comments
<b>Comments</b>	If possible describe if fault can be fixed with software update: <input type="checkbox"/> YES <input type="checkbox"/> NO Describe more specific faults and/or other information
<b>Date</b>	<b>Sign</b>

<b>Test Case</b>	<b>Task 14:6 Service list – NIT_actual interpretation</b>
<b>Section</b>	NorDig Unified 13.2.2, 13.2.1.1
<b>Requirement</b>	<p>The information in the descriptors specified in table 13.1 and table 13.2 shall be displayed. The original network operator name may be omitted in case only one network is available.</p> <p>Note: Table13.1 descriptors</p> <p>Network_name_descriptor Satellite_delivery_system_descriptor Cable_delivery_system_descriptor Terrestrial_delivery_system_descriptor</p> <p>T2_delivery_system_descriptor Service_list_descriptor</p> <p>(Nordig) Logical_channel_descriptor</p>
<b>IRD Profile(s)</b>	Basic, IRD, FE

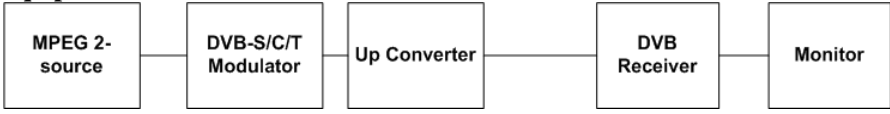

<b>Test procedure</b>	<p><b>Purpose of test:</b> To verify that the information in descriptors are displayed.</p> <p><b>Equipment:</b></p>  <table border="1" data-bbox="391 548 1308 739"> <thead> <tr> <th></th> <th>Service1</th> <th>Service2</th> <th>Frequency</th> </tr> </thead> <tbody> <tr> <td>MUX</td> <td>SID 1100</td> <td>SID 1200</td> <td rowspan="5">Can be chosen depending of the distribution media</td> </tr> <tr> <td>TS_id 1</td> <td>S_name Test11</td> <td>S_name Test12</td> </tr> <tr> <td>Network_id 1</td> <td>PMT PID 1100</td> <td>PMT PID 1200</td> </tr> <tr> <td>ON_id <sup>1)</sup></td> <td>V PID 1109</td> <td>V PID 1209</td> </tr> <tr> <td></td> <td>A PID 1108</td> <td>A PID 1208</td> </tr> <tr> <td></td> <td>Logical_chan_desc 1 visible</td> <td>Logical_chan_desc 2 visible</td> <td></td> </tr> </tbody> </table> <p><sup>1)</sup>ON_id (Original_network_id) can be chosen in range 0x0001-0xFE00 (operational network). Network_name NorDigTest</p> <p><b>Test procedure:</b> Start the Navigator. Check that the following information is available for all services:</p> <ul style="list-style-type: none"> <li>• network name, i.e. NorDigTest</li> <li>• transmission parameters for respective distribution media</li> <li>• service name, i.e. Test11 and Test12 on stored on channel positions 1 and 2.</li> <li>• service type, i.e. Digital television service</li> </ul> <p><b>Expected result:</b> Verify that all the information specified above is available.</p>				Service1	Service2	Frequency	MUX	SID 1100	SID 1200	Can be chosen depending of the distribution media	TS_id 1	S_name Test11	S_name Test12	Network_id 1	PMT PID 1100	PMT PID 1200	ON_id <sup>1)</sup>	V PID 1109	V PID 1209		A PID 1108	A PID 1208		Logical_chan_desc 1 visible	Logical_chan_desc 2 visible	
	Service1	Service2	Frequency																								
MUX	SID 1100	SID 1200	Can be chosen depending of the distribution media																								
TS_id 1	S_name Test11	S_name Test12																									
Network_id 1	PMT PID 1100	PMT PID 1200																									
ON_id <sup>1)</sup>	V PID 1109	V PID 1209																									
	A PID 1108	A PID 1208																									
	Logical_chan_desc 1 visible	Logical_chan_desc 2 visible																									
<b>Test result(s)</b>																											
<b>Conformity</b>	<input type="checkbox"/> <b>OK</b> <input type="checkbox"/> <b>Fault</b> <input type="checkbox"/> Major <input type="checkbox"/> Minor, define fail reason in comments																										
<b>Comments</b>	If possible describe if fault can be fixed with software update: <input type="checkbox"/> <b>YES</b> <input type="checkbox"/> <b>NO</b> Describe more specific faults and/or other information																										
<b>Date</b>		<b>Sign</b>																									

<b>Test Case</b>	<b>Task 14:7 Service list – NIT_actual original_network_ID</b>
<b>Section</b>	Nordig Unified 13.2.2
<b>Requirement</b>	Original_network_ID within 0xFF00-0xFFFF (temporary_private_use), shall only be used for test and (shorter) demonstration transmission. Receiver will not install or display services within these original_network_ids.
<b>IRD Profile(s)</b>	Basic, IRD, FE

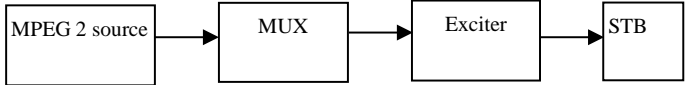
<b>Test procedure</b>	<b>Purpose of test:</b> To test the reception in the test network.																									
	<b>Equipment:</b>																									
																										
	<table border="1" style="width: 100%; border-collapse: collapse;"> <thead> <tr> <th></th> <th>Service1</th> <th>Service2</th> <th>Frequency</th> </tr> </thead> <tbody> <tr> <td>MUX</td> <td>SID 1100</td> <td>SID 1200</td> <td rowspan="5">Can be chosen depending of the distribution media</td> </tr> <tr> <td>TS_id 1</td> <td>S_name Test11</td> <td>S_name Test12</td> </tr> <tr> <td>Network_id 1</td> <td>PMT PID 1100</td> <td>PMT PID 1200</td> </tr> <tr> <td>ON_id <sup>1)</sup></td> <td>V PID 1109</td> <td>V PID 1209</td> </tr> <tr> <td></td> <td>A PID 1108</td> <td>A PID 1208</td> </tr> <tr> <td></td> <td>Logical_chan_desc 1 visible</td> <td>Logical_chan_desc 2 visible</td> <td></td> </tr> </tbody> </table>			Service1	Service2	Frequency	MUX	SID 1100	SID 1200	Can be chosen depending of the distribution media	TS_id 1	S_name Test11	S_name Test12	Network_id 1	PMT PID 1100	PMT PID 1200	ON_id <sup>1)</sup>	V PID 1109	V PID 1209		A PID 1108	A PID 1208		Logical_chan_desc 1 visible	Logical_chan_desc 2 visible	
		Service1	Service2	Frequency																						
MUX	SID 1100	SID 1200	Can be chosen depending of the distribution media																							
TS_id 1	S_name Test11	S_name Test12																								
Network_id 1	PMT PID 1100	PMT PID 1200																								
ON_id <sup>1)</sup>	V PID 1109	V PID 1209																								
	A PID 1108	A PID 1208																								
	Logical_chan_desc 1 visible	Logical_chan_desc 2 visible																								
<sup>1)</sup> ON_id (Original_network_id) can be chosen in range 0x0001-0xfe00 (operational network) and it shall be same for both muxes.																										
<b>Test procedure:</b> <ol style="list-style-type: none"> <li>1. Turn on receiver.</li> <li>2. Do re-initialization or make sure there are no services in channel list or in ESG.</li> <li>3. Make sure that the ON_id is on the range of the operational network.</li> <li>4. Do channel search.</li> <li>5. Check in channel list or ESG that the services are available.</li> <li>6. Change ON_id to 0xFF00.</li> <li>7. Do re-initialization or make sure there are no services in channel list or in ESG.</li> <li>8. Do channel search.</li> <li>9. Check that receiving ON_id 0xFF00/FFFF does not stop the scanning procedure, this frequency is just skipped.</li> <li>10. Check in channel list or ESG that there are no services available.</li> <li>11. Change ON_id to 0xFFFF.</li> <li>12. Repeat from test point 7.</li> </ol>																										
<b>Expected result:</b> Services are not available for ON-id range 0xFF00 – 0xFFFF.																										
<b>Test result(s)</b>																										
<b>Conformity</b>	<input type="checkbox"/> OK <input type="checkbox"/> Fault <input type="checkbox"/> Major <input type="checkbox"/> Minor, define fail reason in comments																									
<b>Comments</b>	If possible describe if fault can be fixed with software update: <input type="checkbox"/> YES <input type="checkbox"/> NO Describe more specific faults and/or other information																									
<b>Date</b>	<b>Sign</b>																									

<b>Test Case</b>	<b>Task 14:8 Service list – NIT_actual network_ID</b>
<b>Section</b>	Nordig Unified 13.2.2
<b>Requirement</b>	Network_ID within 0xFF01-0xFFFF (temporary_private_use), shall only be used for test and (shorter) demonstration transmission. Receiver will not install or display services within these network_ids.
<b>IRD Profile(s)</b>	Basic, IRD, FE
<b>Test procedure</b>	<b>Purpose of test:</b> To test the reception in the test network.
<b>Equipment:</b>	

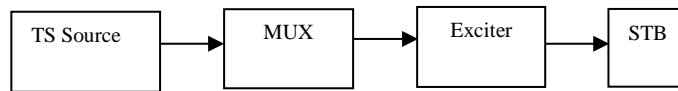

	Service2	Service2	Frequency
MUX	SID 1100	SID 1200	Can be chosen depending of the distribution media.
TS_id 1	S_name Test11	S_name Test12	
Network_id <sup>1)</sup>	PMT PID 1100	PMT PID 1200	
ON_id <sup>2)</sup>	V PID 1109	V PID 1209	
	A PID 1108	A PID 1208	
	Logical_chan_desc 1 visible	Logical_chan_desc 2 visible	

<sup>1)</sup> Network\_id on the range 0x0001 – 0xFDFF (operational network).

<sup>2)</sup> ON\_id (Original\_network\_id) can be chosen on range 0x0001-0xFE00 (operational network)

**Test procedure:**

1. Turn on receiver.
2. Do re-initialization or make sure there are no services in channel list or in ESG.
3. Make sure that the network\_id is on the range of the operational network.
4. Do channel search.
5. Check in channel list or ESG that there are no services available.
6. Change the network\_id to 0xFF01.
7. Do re-initialization or make sure there are no services in channel list or in ESG.
8. Do channel search.
- 9.** Check that receiving network\_id 0xFF01/FFFF does not stop the scanning procedure, this frequency is just skipped.
10. Check in channel list or ESG that there are no services available.
11. Change the network\_id to 0xFFFF.
12. Repeat from test point 7.

**Expected result:**

Services are not available for network\_id range 0xFF01 – 0xFFFF.

<b>Test result(s)</b>	
<b>Conformity</b>	<input type="checkbox"/> OK <input type="checkbox"/> Fault <input type="checkbox"/> Major <input type="checkbox"/> Minor, define fail reason in comments
<b>Comments</b>	If possible describe if fault can be fixed with software update: <input type="checkbox"/> YES <input type="checkbox"/> NO Describe more specific faults and/or other information
<b>Date</b>	<b>Sign</b>

<b>Test Case</b>	<b>Task 14:9 Service list – Inconsistent SDT_actual/NIT_actual and SDT_other/NIT_other</b>
<b>Section</b>	NorDig Rules Of Operation 2.6.2
<b>Requirement</b>	
<b>IRD Profile(s)</b>	Basic, IRD, FE
<b>Test procedure</b>	Purpose of the test: To verify if the IRD updates service list quasi-static from SDT_actual instead of NIT_actual service_list_descriptor.  Equipment:

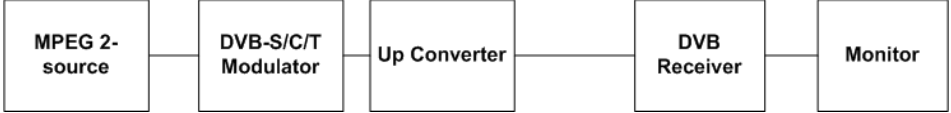
			
	<p>Test procedure:</p> <p>Service_list in NIT is optional to broadcast. Therefore, it is important to verify how the receiver extract information from the SDT_actual and NIT_actual service_list in case the information is inconsistent.</p> <p>Transport stream shall have at least one service configured. The SDT_actual signalize the service, but the service_list_descriptor in NIT_actual shall not have the service listed.</p> <p>Test procedure:</p> <ol style="list-style-type: none"> <li>1. Make first time installation of the IRD</li> <li>2. Verify the service_list_descriptor doesn't list at least one of the services carried within transport stream. With other words, there is inconsistent between SDT_actual and service_list_descriptor in NIT_actual</li> <li>3. Verify that all the carried services within transport stream are in the service list.</li> </ol> <p>Expected result:</p> <p>Services, carried within transport stream and listed in SDT_actual, are listed in service list independently if the services are listed in service_list_descriptor in NIT_actual.</p>		
<b>Test result(s)</b>			
<b>Conformity</b>	<input type="checkbox"/> <b>OK</b> <input type="checkbox"/> <b>Fault</b> <input type="checkbox"/> Major <input type="checkbox"/> Minor, define fail reason in comments		
<b>Comments</b>	If possible describe if fault can be fixed with software update: <input type="checkbox"/> <b>YES</b> <input type="checkbox"/> <b>NO</b> Describe more specific faults and/or other information		
<b>Date</b>		<b>Sign</b>	

<b>Test Case</b>	<b>Task 14:10 Service list – Handling of multiple channel lists from same networks and NorDig LCD</b>
<b>Section</b>	NorDig Unified 12.2.9.3.2
<b>Requirement</b>	<p>The Logical Channel Descriptor version 2 enables transmission within same network of multiple Channel lists, meaning that there might it be several channel lists available for a IRD to choose between. The NorDig IRD may treat each channel list as complete with all intended services for that network (original network id) and it is up to the broadcaster to ensure that all intended services are included in all lists.</p> <p>The NorDig IRD shall at least store the sorting from one of the available Channel lists as default, but it is recommended that theNorDig IRD store all the transmitted Channel Lists sorting that matches the IRD's country code settings (especially for IRDs that are not letting the user choose list during installation).</p> <p>When several Channel Lists are available from same network (original network id) for the IRD during first time installation (or complete re-installation), the NorDig IRD shall choose the channel list as the default one with following priority:</p> <ol style="list-style-type: none"> <li>1.The list with same country code as the IRD's user preference setting's country code. If several list available with same matching country code, the IRD shall choose the one with lowest list_id value OR let the viewer choose from a list, (typically using the channel_list_name)</li> <li>2.If no Channel list has a country code that matches the user preference setting's country</li> </ol>



channel lists IDs.

For cable and terrestrial networks, a subset of channel lists is required as long as one and same ON\_id is in concern. Transmissions in these networks are not normally dedicated for receivers with different country settings. Therefore, two channel list (e.g. ListDNKpri and ListDNKsec) with same country\_code is enough to test requirement in this test.

The channel list under test shall not be signaled with channel\_list\_ID 1. E.g. if receiver dedicated to Swedish market is under test, ListSWEpri shall be signaled with other channel\_list\_ID than 1 in order to avoid malfunction in receiver where the receiver selects first list found.

MUX1:

Channel_list_ID	Channel list name	Country_code
1	ListSWEpri	SWE
2	ListFINpri	FIN
3	ListNORpri	NOR
4	ListDNKpri	DNK
5	ListIRLpri	IRL
6	ListSWEsec	SWE
7	ListFINsec	FIN
8	ListNORsec	NOR
9	ListDNKsec	DNK
10	ListIRLsec	IRL

MUX2:

Channel_list_ID	Channel list name	Country_code
1	ListSWEpri	SWE
2	ListFINpri	FIN
3	ListNORpri	NOR
4	ListDNKpri	DNK
5	ListIRLpri	IRL
6	ListSWEsec	SWE
7	ListFINsec	FIN
8	ListNORsec	NOR
9	ListDNKsec	DNK
10	ListIRLsec	IRL

**Test procedure:**

Receiver country is equal as channel list country\_code:

1. Perform factory reset to the receiver
2. Perform channel search
3. Verify that the all services are found
4. The channel list with lowest channel list ID is automatically selected by the receiver or the user is able to select the channel list.

Receiver country is not equal as channel list country\_code:

5. Perform factory reset to the receiver
6. Perform channel search
7. Verify that the all services are found



8. The channel list is either user selectable or automatically selected by the receiver according to lowest channel list ID.

**Expected result:**

The channel list with same country code as the IRD's user preference setting's country code the IRD shall choose the one with lowest list\_id value OR let the viewer choose from a list (typically using the channel\_list\_name).

If no Channel list has a country code that matches the user preference setting's country code, the IRD shall let the viewer choose from a list (recommended) OR choose the one with lowest list\_id value.

Service name	Logical channel position(SWE)	Logical channel position(FIN)	Logical channel position(NOR)	Logical channel position(DNK)	Logical channel position(IRL)	Channel list
Test11	1	2	1	1	4	Either with lowest channel list ID (primary) or user selected
Test12	2	1	3	2	2	
Test21	3	3	2	4	3	
Test22	4	4	4	3	1	

<b>Test result(s)</b>	
<b>Conformity</b>	<input type="checkbox"/> <b>OK</b> <input type="checkbox"/> <b>Fault</b> <input type="checkbox"/> Major <input type="checkbox"/> Minor, define fail reason in comments
<b>Comments</b>	If possible describe if fault can be fixed with software update: <input type="checkbox"/> <b>YES</b> <input type="checkbox"/> <b>NO</b> Describe more specific faults and/or other information
<b>Date</b>	<b>Sign</b>

<b>Test Case</b>	<b>Task 14:11 Service list – Simultaneous transmission of LCD v1 and v2</b>
<b>Section</b>	NorDig Unified 12.2.9.4
<b>Requirement</b>	When broadcasting both LCD version 1 and version 2 within one Original Network ID, the NorDig IRDs supporting both descriptors shall only sort according to the version 2 (i.e. NorDig LCD version 2 has higher priority).
<b>IRD Profile(s)</b>	Basic, IRD, FE
<b>Test procedure</b>	<b>Purpose of test:</b> To verify the support for simultaneous transmission of LCD ver.1 and Ver2.  <b>Equipment:</b>

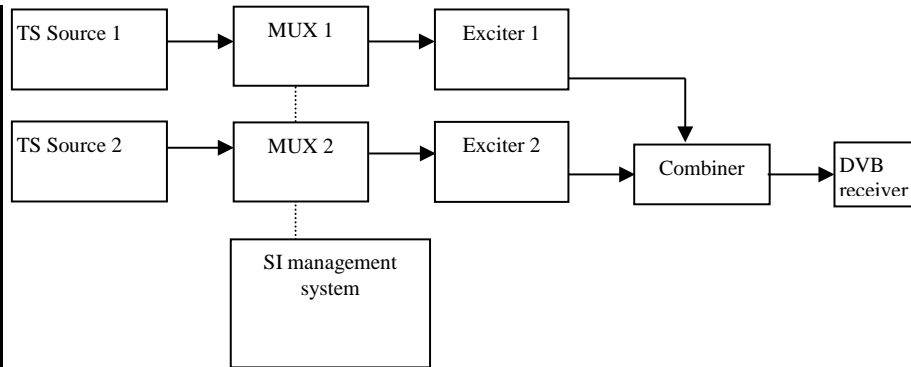

	Service1	Service2	Service3	Frequency
<b>MUX1</b> TS_id 1 Network_id 1 ON_id <sup>1)</sup>	SID 1100 S_name Test11 S_type 0x01 PMT PID 1100 V PID 1109 A PID 1108 LCN Ver.1: 1 visible LCN Ver.2: 2 visible	SID 1200 S_name Test12 S_type 0x01 PMT PID 1200 V PID 1209 A PID 1208 LCN Ver.1: 2 visible LCN Ver.2: 1 visible	SID 1300 S_name Test13 S_type 0x01 PMT PID 1300 V PID 1309 A PID 1308 LCN Ver.1: 3 visible LCN Ver.2: 3 visible	Can be chosen depending of the distribution media
<b>MUX2</b> TS_id 2 Network_id 2 ON_id <sup>1)</sup>	SID 2100 S_name Test21 S_type 0x01 PMT PID 2100 V PID 2109 A PID 2108 LCN Ver.1: 4 visible LCN Ver.2: 5 visible	SID 2200 S_name Test22 S_type 0x01 PMT PID 2200 V PID 2209 A PID 2208 LCN Ver.1: - LCN Ver.2: -		Can be chosen depending of the distribution media, but cannot be same as in MUX1

<sup>1)</sup>ON\_id (Original\_network\_id) can be chosen in range 0x0001-0xfe00 (operational network) and it shall be same for both muxes

<sup>2)</sup>Network\_id for DVB-C and DVB-S/S2 IRD tests shall be same in all muxes

Note: It is not obvious that network operators will broadcast different LCN in different version of LCD. However, for testing purposes, different LCNs are broadcasted.

**Test procedure:**

1. Perform factory reset to the receiver
2. Perform automatic channel search
3. Verify that the all services are found
4. Verify that the services are stored according the LCD version 2 signaling.

**Expected result:**

The channel numbers are correct.

Service in service list should be stored as listed below:

Service name	IRD supports version 2
Test12	1
Test11	2
Test13	3
Test21	5
Test22	Last in the list

**Test result(s)**

**Conformity**  OK Fault  Major  Minor, define fail reason in comments





<b>Comments</b>	If possible describe if fault can be fixed with software update: <input type="checkbox"/> YES <input type="checkbox"/> NO Describe more specific faults and/or other information
<b>Date</b>	<b>Sign</b>

<b>Test Case</b>	<b>Task 14:12 Service list – Simultaneous reception of multiple networks and NorDig LCD</b>
------------------	---------------------------------------------------------------------------------------------

<b>Section</b>	NorDig Unified 12.2.9.5
----------------	-------------------------

<b>Requirement</b>	<p>The NorDig IRD with terrestrial front-end shall be able to install several (DTT) original networks (with different original network ids).</p> <p>For multiple original networks (original network ids) the NorDig IRD shall first sort/list all services from one original network (original network id) according to that LCD, before sorting/listing the next original network. The first original network is the primary network and any additional received original networks are referred to as secondary network(s).</p> <p>The user shall be able to set which original network that shall be the primary, either via the user preferences, e.g. matching country setting (preferred) or via user selectable list of available original networks or similar mechanism. In order to simplify this, the NorDig IRD should map/translate the original network id into the country name. This means that for IRD where the user has set the country setting, the primary network should automatic be the country matching the original network id (and its services shall be listed first in the NorDig IRD’s service list).</p>
--------------------	----------------------------------------------------------------------------------------------------------------------------------------------------------------------------------------------------------------------------------------------------------------------------------------------------------------------------------------------------------------------------------------------------------------------------------------------------------------------------------------------------------------------------------------------------------------------------------------------------------------------------------------------------------------------------------------------------------------------------------------------------------------------------------------------------------------------------------------------------------------------------------------------------------------------------------------------------------------------------------------------------------------------------------------------------------------------------------------------------------------------------------------

<b>IRD Profile(s)</b>	Basic, IRD, DVB-T, DVB-T2
-----------------------	---------------------------

<b>Test procedure</b>	<p><b>Purpose of test:</b> To verify the support for the reception of multiple networks and NorDig LCN.</p> <p><b>Equipment:</b></p> <pre> graph LR     TS1[TS Source 1] --&gt; MUX1[MUX 1]     TS2[TS Source 2] --&gt; MUX2[MUX 2]     MUX1 -.-&gt; SI[SI management system]     MUX2 -.-&gt; SI     MUX1 --&gt; Exc1[Exciter 1]     MUX2 --&gt; Exc2[Exciter 2]     Exc1 --&gt; Comb[Combiner]     Exc2 --&gt; Comb     Comb --&gt; DVB[DVB receiver]     </pre> <table border="1"> <thead> <tr> <th></th> <th>Service1</th> <th>Service2</th> <th>Service3</th> <th>Frequency</th> </tr> </thead> <tbody> <tr> <td><b>MUX1</b> TS_id 1 Network_id 1 ON_id X<sup>1)</sup></td> <td>SID 1100 S_name Test11 S_type 0x01 PMT PID 1100 V PID 1109 A PID 1108 LCN 2 visible</td> <td>SID 1200 S_name Test12 S_type 0x01 PMT PID 1200 V PID 1209 A PID 1208 LCN 5 visible</td> <td>SID 1300 S_name Test13 S_type 0x01 PMT PID 1300 V PID 1309 A PID 1308 LCN 6 visible</td> <td>Can be chosen depending of the distribution media</td> </tr> <tr> <td><b>MUX2</b> TS_id 2 Network_id 2 ON_id Y<sup>1)</sup></td> <td>SID 2100 S_name Test21 S_type 0x01 PMT PID 2100 V PID 2109 A PID 2108 LCN 2 visible</td> <td>SID 2200 S_name Test22 S_type 0x01 PMT PID 2200 V PID 2209 A PID 2208 LCN 4 visible</td> <td>SID 2300 S_name Test23 S_type 0x01 PMT PID 2300 V PID 2309 A PID 2308 LCN 7 visible</td> <td>Can be chosen depending of the distribution media, but cannot be same as in MUX1</td> </tr> </tbody> </table>		Service1	Service2	Service3	Frequency	<b>MUX1</b> TS_id 1 Network_id 1 ON_id X <sup>1)</sup>	SID 1100 S_name Test11 S_type 0x01 PMT PID 1100 V PID 1109 A PID 1108 LCN 2 visible	SID 1200 S_name Test12 S_type 0x01 PMT PID 1200 V PID 1209 A PID 1208 LCN 5 visible	SID 1300 S_name Test13 S_type 0x01 PMT PID 1300 V PID 1309 A PID 1308 LCN 6 visible	Can be chosen depending of the distribution media	<b>MUX2</b> TS_id 2 Network_id 2 ON_id Y <sup>1)</sup>	SID 2100 S_name Test21 S_type 0x01 PMT PID 2100 V PID 2109 A PID 2108 LCN 2 visible	SID 2200 S_name Test22 S_type 0x01 PMT PID 2200 V PID 2209 A PID 2208 LCN 4 visible	SID 2300 S_name Test23 S_type 0x01 PMT PID 2300 V PID 2309 A PID 2308 LCN 7 visible	Can be chosen depending of the distribution media, but cannot be same as in MUX1
	Service1	Service2	Service3	Frequency												
<b>MUX1</b> TS_id 1 Network_id 1 ON_id X <sup>1)</sup>	SID 1100 S_name Test11 S_type 0x01 PMT PID 1100 V PID 1109 A PID 1108 LCN 2 visible	SID 1200 S_name Test12 S_type 0x01 PMT PID 1200 V PID 1209 A PID 1208 LCN 5 visible	SID 1300 S_name Test13 S_type 0x01 PMT PID 1300 V PID 1309 A PID 1308 LCN 6 visible	Can be chosen depending of the distribution media												
<b>MUX2</b> TS_id 2 Network_id 2 ON_id Y <sup>1)</sup>	SID 2100 S_name Test21 S_type 0x01 PMT PID 2100 V PID 2109 A PID 2108 LCN 2 visible	SID 2200 S_name Test22 S_type 0x01 PMT PID 2200 V PID 2209 A PID 2208 LCN 4 visible	SID 2300 S_name Test23 S_type 0x01 PMT PID 2300 V PID 2309 A PID 2308 LCN 7 visible	Can be chosen depending of the distribution media, but cannot be same as in MUX1												

	<p><sup>1)</sup>ON_id (Original_network_id) can be chosen in range 0x0001-0xfe00 (operational network). Values for X and Y shall be selected different.</p> <p>Note for services belonging to secondary ON_id: SDT_actual service order shall not be equal with LCN number order because this may result to a situation that the receiver has sorted the services according to SDT_actual service order instead of the LCN number order.</p> <p><b>Test procedure:</b></p> <ol style="list-style-type: none"> <li>1. Perform factory reset to the receiver</li> <li>2. The primary network is either user selectable or automatically based on the country settings in the receiver.</li> <li>3. Perform channel search</li> <li>4. Verify that the all services are found</li> <li>5. Verify that the services are ordered firstly by the ON_id and secondly by the LCD.</li> </ol> <p><b>Expected result:</b></p> <p>User is able to select which network is the primary network.</p> <p>The channel numbers are correct.</p> <p>Service in service list should be stored as listed below:</p> <table border="1" data-bbox="497 1034 1230 1292"> <thead> <tr> <th>Service name</th> <th>ON_id X as primary</th> <th>ON_id Y as primary</th> </tr> </thead> <tbody> <tr> <td>Test11</td> <td>2</td> <td>Last in the list e.g. 8</td> </tr> <tr> <td>Test12</td> <td>5</td> <td>Last in the list e.g. 9</td> </tr> <tr> <td>Test13</td> <td>6</td> <td>Last in the list e.g. 10</td> </tr> <tr> <td>Test21</td> <td>Last in the list, e.g. 7</td> <td>2</td> </tr> <tr> <td>Test22</td> <td>Last in the list, e.g. 8</td> <td>4</td> </tr> <tr> <td>Test23</td> <td>Last in the list, e.g. 9</td> <td>7</td> </tr> </tbody> </table>	Service name	ON_id X as primary	ON_id Y as primary	Test11	2	Last in the list e.g. 8	Test12	5	Last in the list e.g. 9	Test13	6	Last in the list e.g. 10	Test21	Last in the list, e.g. 7	2	Test22	Last in the list, e.g. 8	4	Test23	Last in the list, e.g. 9	7
Service name	ON_id X as primary	ON_id Y as primary																				
Test11	2	Last in the list e.g. 8																				
Test12	5	Last in the list e.g. 9																				
Test13	6	Last in the list e.g. 10																				
Test21	Last in the list, e.g. 7	2																				
Test22	Last in the list, e.g. 8	4																				
Test23	Last in the list, e.g. 9	7																				
<b>Test result(s)</b>																						
<b>Conformity</b>	<input type="checkbox"/> OK Fault <input type="checkbox"/> Major <input type="checkbox"/> Minor, define fail reason in comments																					
<b>Comments</b>	If possible describe if fault can be fixed with software update: <input type="checkbox"/> YES <input type="checkbox"/> NO Describe more specific faults and/or other information																					
<b>Date</b>	<b>Sign</b>																					

<b>Test Case</b>	<b>Task 14:13 Service list - Priority of LCN between SD and HDTV services</b>
<b>Section</b>	NorDig Unified 12.2.9.2.3, 12.2.9.3.4 and 13.2
<b>Requirement</b>	<p>If several services are allocated to the same logic_channel_number, (within the same channel list, as may be the case if several terrestrial regions can be received at the same location or several satellite networks are received), one service shall be ordered according to the logic_channel_number and the others shall be placed last in that list.</p> <p>Empty spaces in the broadcast logic channel numbering shall then not be used;instead they shall be located last, after the service with highest logic channel number of that service_type.(The broadcaster may quite consciously choose to leave empty spaces in the logic channel numbering, for future services, etc, in order to avoid a complete rearrangement of the list).</p>

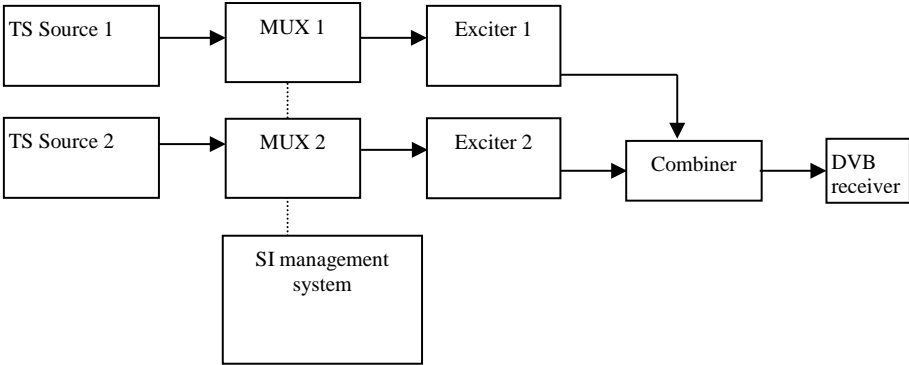
	<p>Whenever two or more services within same category are allocated to the same logical_channel_number, the HD IRD shall priorities the advanced codec services as following for TV category; first 0x19 adv codec HDTV service, secondly 0x16 adv codec SDTV service and last 0x01 (MPEG-2 SD) TV service and for radio category; first 0x0A adv codec radio and secondly 0x02 radio service types.</p> <p>Whenever two or more services within same category are allocated to the same logical_channel_number, the NorDig HDTV IRD shall first priorities the advanced codec services as stated in Table12.1 above (see chapter 12.1.4 for priority between different services within same service category).</p>															
<p><b>IRD Profile(s)</b></p>	<p>Basic, IRD, FE</p>															
<p><b>Test procedure</b></p>	<p><b>Purpose of test:</b> To verify the support for priority of LCN between SD and HD services.</p> <p><b>Equipment:</b></p>  <table border="1" data-bbox="387 1178 1337 1653"> <thead> <tr> <th></th> <th>Service1</th> <th>Service2</th> <th>Service3</th> <th>Frequency</th> </tr> </thead> <tbody> <tr> <td><b>MUX1</b> TS_id 1 Network_id 1 ON_id <sup>1)</sup></td> <td>SID 1100 S_name Test11 S_type 0x01 PMT PID 1100 V PID 1109 A PID 1108 LCN Ver.1: 1 visible LCN Ver.2: 1 visible</td> <td>SID 1200 S_name Test12 S_type 0x01 PMT PID 1200 V PID 1209 A PID 1208 LCN Ver.1: 2 visible LCN Ver.2: 2 visible</td> <td>SID 1300 S_name Test13 S_type 0x02 PMT PID 1300  A PID 1308 LCN Ver.1: 3 visible LCN Ver.2: 3 visible</td> <td>Can be chosen depending of the distribution media</td> </tr> <tr> <td><b>MUX2</b> TS_id 1 Network_id 2 ON_id <sup>1)</sup></td> <td>SID 2100 S_name Test21 S_type 0x19 PMT PID 2100 V PID 2109 A PID 2108 LCN Ver.1: 1 visible LCN Ver.2: 1 visible</td> <td>SID 2200 S_name Test22 S_type 0x16 PMT PID 2200 V PID 2209 A PID 2208 LCN Ver.1: 2 visible LCN Ver.2: 2 visible</td> <td>SID 2300 S_name Test23 S_type 0x0A PMT PID 2300  A PID 2308 LCD ver.1: 3 visible LCD ver.2: 3 visible</td> <td>Can be chosen depending of the distribution media, but cannot be same as in MUX1</td> </tr> </tbody> </table> <p><sup>1)</sup>ON_id (Original_network_id) can be chosen in range 0x0001-0xfe00 (operational network) and it shall be same for both muxes. <sup>2)</sup>Network_id for DVB-C and DVB-S/S2 IRD tests shall be same in all muxes</p> <p>Note 1: Receiver can use the service_type when sorting the HD and SD services. Note 2: Test13 (HD) has higher priority than Test21 (SD) in HDTV receiver.</p> <p>Channel list ID is set to 1 with country code equal to receiver country settings.</p> <p>The TS_id is set to 1, but the network_id differs between multiplexes. This configuration simulates terrestrial regions.</p>		Service1	Service2	Service3	Frequency	<b>MUX1</b> TS_id 1 Network_id 1 ON_id <sup>1)</sup>	SID 1100 S_name Test11 S_type 0x01 PMT PID 1100 V PID 1109 A PID 1108 LCN Ver.1: 1 visible LCN Ver.2: 1 visible	SID 1200 S_name Test12 S_type 0x01 PMT PID 1200 V PID 1209 A PID 1208 LCN Ver.1: 2 visible LCN Ver.2: 2 visible	SID 1300 S_name Test13 S_type 0x02 PMT PID 1300  A PID 1308 LCN Ver.1: 3 visible LCN Ver.2: 3 visible	Can be chosen depending of the distribution media	<b>MUX2</b> TS_id 1 Network_id 2 ON_id <sup>1)</sup>	SID 2100 S_name Test21 S_type 0x19 PMT PID 2100 V PID 2109 A PID 2108 LCN Ver.1: 1 visible LCN Ver.2: 1 visible	SID 2200 S_name Test22 S_type 0x16 PMT PID 2200 V PID 2209 A PID 2208 LCN Ver.1: 2 visible LCN Ver.2: 2 visible	SID 2300 S_name Test23 S_type 0x0A PMT PID 2300  A PID 2308 LCD ver.1: 3 visible LCD ver.2: 3 visible	Can be chosen depending of the distribution media, but cannot be same as in MUX1
	Service1	Service2	Service3	Frequency												
<b>MUX1</b> TS_id 1 Network_id 1 ON_id <sup>1)</sup>	SID 1100 S_name Test11 S_type 0x01 PMT PID 1100 V PID 1109 A PID 1108 LCN Ver.1: 1 visible LCN Ver.2: 1 visible	SID 1200 S_name Test12 S_type 0x01 PMT PID 1200 V PID 1209 A PID 1208 LCN Ver.1: 2 visible LCN Ver.2: 2 visible	SID 1300 S_name Test13 S_type 0x02 PMT PID 1300  A PID 1308 LCN Ver.1: 3 visible LCN Ver.2: 3 visible	Can be chosen depending of the distribution media												
<b>MUX2</b> TS_id 1 Network_id 2 ON_id <sup>1)</sup>	SID 2100 S_name Test21 S_type 0x19 PMT PID 2100 V PID 2109 A PID 2108 LCN Ver.1: 1 visible LCN Ver.2: 1 visible	SID 2200 S_name Test22 S_type 0x16 PMT PID 2200 V PID 2209 A PID 2208 LCN Ver.1: 2 visible LCN Ver.2: 2 visible	SID 2300 S_name Test23 S_type 0x0A PMT PID 2300  A PID 2308 LCD ver.1: 3 visible LCD ver.2: 3 visible	Can be chosen depending of the distribution media, but cannot be same as in MUX1												

	<p>Services in MUX1 are using MPEG-2 video and MPEG-1 LII audio. Services in MUX2 are allowed only use advanced coded video and audio, with other words, MPEG-4 AVC video and HE-AAC or E-AC-3 audio.</p> <p>The reception quality from both frequencies must be such a good that the terrestrial receiver doesn't do any best service selection.</p> <p><b>Test procedure:</b></p> <ol style="list-style-type: none"> <li>1. Perform factory reset to the receiver</li> <li>2. Perform channel search</li> <li>3. Verify that the all services are found</li> <li>4. Verify that the services are ordered according the priority</li> </ol> <p><b>Expected result:</b> The channel numbers are correct.</p> <p>In SDTV receivers only SDTV services are listed in service list according to their categories.</p> <p>In HDTV receivers HDTV services are prioritized over SDTV services in correct categories. SDTV services are listed last in the service list.</p> <p>Services in service list should be stored as in correct categories.</p>																																																												
<b>Test result(s)</b>	<p>Measurement record:</p> <table border="1" style="margin-left: auto; margin-right: auto; border-collapse: collapse;"> <thead> <tr> <th colspan="5">SDTV receiver with support</th> </tr> <tr> <th>Pos</th> <th>'TV'</th> <th>'Radio'</th> <th>'Data/Other'</th> <th>NOK or OK</th> </tr> </thead> <tbody> <tr> <td>1</td> <td>Test11</td> <td></td> <td></td> <td></td> </tr> <tr> <td>2</td> <td>Test12</td> <td></td> <td></td> <td></td> </tr> <tr> <td>3</td> <td></td> <td>Test13</td> <td></td> <td></td> </tr> </tbody> </table> <table border="1" style="margin-left: auto; margin-right: auto; border-collapse: collapse;"> <thead> <tr> <th colspan="5">HDTV receiver</th> </tr> <tr> <th>Pos</th> <th>'TV'</th> <th>'Radio'</th> <th>'Data/Other'</th> <th>NOK or OK</th> </tr> </thead> <tbody> <tr> <td>1</td> <td>Test21</td> <td></td> <td></td> <td></td> </tr> <tr> <td>2</td> <td>Test22</td> <td></td> <td></td> <td></td> </tr> <tr> <td>3</td> <td></td> <td>Test23</td> <td></td> <td></td> </tr> <tr> <td>Last in the list</td> <td>Test11</td> <td>Test13</td> <td></td> <td></td> </tr> <tr> <td>Last in the list</td> <td>Test12</td> <td></td> <td></td> <td></td> </tr> </tbody> </table>	SDTV receiver with support					Pos	'TV'	'Radio'	'Data/Other'	NOK or OK	1	Test11				2	Test12				3		Test13			HDTV receiver					Pos	'TV'	'Radio'	'Data/Other'	NOK or OK	1	Test21				2	Test22				3		Test23			Last in the list	Test11	Test13			Last in the list	Test12			
SDTV receiver with support																																																													
Pos	'TV'	'Radio'	'Data/Other'	NOK or OK																																																									
1	Test11																																																												
2	Test12																																																												
3		Test13																																																											
HDTV receiver																																																													
Pos	'TV'	'Radio'	'Data/Other'	NOK or OK																																																									
1	Test21																																																												
2	Test22																																																												
3		Test23																																																											
Last in the list	Test11	Test13																																																											
Last in the list	Test12																																																												
<b>Conformity</b>	<input type="checkbox"/> <b>OK Fault</b> <input type="checkbox"/> Major <input type="checkbox"/> Minor, define fail reason in comments																																																												
<b>Comments</b>	<p>If possible describe if fault can be fixed with software update: <input type="checkbox"/> <b>YES</b> <input type="checkbox"/> <b>NO</b></p> <p>Describe more specific faults and/or other information</p>																																																												
<b>Date</b>	<table border="1" style="display: inline-table; border-collapse: collapse;"> <tr> <td style="width: 100px; height: 20px;"></td> <td style="width: 100px; height: 20px;"></td> </tr> </table> <b>Sign</b>																																																												



<b>Test Case</b>	<b>Task 14:14 Quasi-static update of service list – service addition</b>
<b>Section</b>	NorDig Unified 12.1 and 13.2.4
<b>Requirement</b>	<p>The IRD shall at least start updating for any changes in the received “quasi-static” SI data, (NIT and SDT i.e. SI that is normally stored in the flash memory for service navigations such as service_name, service_ID, number of services), after it return to active from stand-by mode.</p> <p>... Initiation of update in the Service List that the IRD is not able to perform in the ‘background’ without disturbances or user action/confirmation, shall (only) be made after manual power up or after user selection to an affected service/transport stream (e.g. when re-scanning is needed).</p>
<b>IRD Profile(s)</b>	Basic, IRD, FE
<b>Test procedure</b>	<p><b>Purpose of the test:</b> To check that the IRD updates service list quasi-static when a service is added within transport stream.</p> <p><b>Equipment:</b></p> <pre> graph LR     A[MPEG 2-source] --- B[DVB-S/C/T Modulator]     B --- C[Up Converter]     C --- D[DVB Receiver]     D --- E[Monitor]     </pre> <p>NOTE: For the terrestrial networks where several transmitters can be received simultaneously, it is important to verify the parameters original_network_id, transport_stream_id and service_id to make a service unique. In cases where original_network_id and transport_stream_id are the same, but the services carried within transport stream differs, network_id can be interpreted to verify if the transport stream belongs to an other region.</p> <p><b>Test procedure:</b></p> <p>In initial phase transport stream carries at least one service. In second phase at least one new service is added inclusive the required PSI/SI signalization parameters.</p> <ol style="list-style-type: none"> <li>1. Make first time installation of the IRD or verify that the receiver doesn't have the service which will be added in the service list already installed in the service list..</li> <li>2. Check that the original service is accessed.</li> <li>3. Add a new service within transport stream             <ol style="list-style-type: none"> <li>a. Verify the service is added in SDT_actual, PAT and PMT.</li> <li>b. Verify the service is added in service in service_list_descriptor in NIT_actual</li> </ol> </li> <li>4. Toggle receiver from active mode to standby mode and from standby mode to active mode</li> <li>5. Verify the added service is added to service list.</li> </ol> <p><b>Expected result:</b> IRD automatically adds and updates the new service in the service list The service it is accessible.</p>
<b>Test result(s)</b>	<p>If possible, mark when the service addition is done:</p> <p><input type="checkbox"/> From active mode to stand-by mode</p> <p><input type="checkbox"/> From stand-by mode to active mode</p> <p><input type="checkbox"/> In stand-by mode</p>

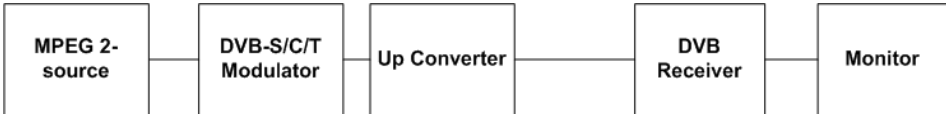

<b>Conformity</b>	<input type="checkbox"/> OK Fault <input type="checkbox"/> Major <input type="checkbox"/> Minor, define fail reason in comments	
<b>Comments</b>	If possible describe if fault can be fixed with software update: <input type="checkbox"/> YES <input type="checkbox"/> NO Describe more specific faults and/or other information	
<b>Date</b>		<b>Sign</b>

<b>Test Case</b>	<b>Task 14:15 Quasi-static update of service list – non-visible data service addition</b>																																	
<b>Section</b>	NorDig Unified 12.1 and 13.2.4																																	
<b>Requirement</b>	<p>The IRD shall at least start updating for any changes in the received “quasi-static” SI data, (NIT and SDT i.e. SI that is normally stored in the flash memory for service navigations such as service_name, service_ID, number of services), after it return to active from stand-by mode.</p> <p>... Initiation of update in the Service List that the IRD is not able to perform in the ‘background’ without disturbances or user action/confirmation, shall (only) be made after manual power up or after user selection to an affected service/transport stream (e.g. when re-scanning is needed).</p>																																	
<b>IRD Profile(s)</b>	Basic, IRD, FE																																	
<b>Test procedure</b>	<p><b>Purpose of test:</b> To verify that the IRD does not add a “non-visible” data service (Service type 0x0C, LCN: 0 non-visible) in the service list quasi-statically when such a service is added within transport stream.</p> <p><b>Equipment:</b></p>  <table border="1" data-bbox="397 1267 1326 1496"> <thead> <tr> <th></th> <th>Service1</th> <th>Service2</th> <th>Frequency</th> </tr> </thead> <tbody> <tr> <td><b>MUX1</b></td> <td>SID 1100</td> <td>SID 1200</td> <td rowspan="6">Can be chosen depending of the distribution media.</td> </tr> <tr> <td>TS_id 1</td> <td>S_name Test11</td> <td>S_name Test21</td> </tr> <tr> <td>Network_id 1</td> <td>S type 1</td> <td>S type 12</td> </tr> <tr> <td>ON_id <sup>1)</sup></td> <td>PMT PID 1100</td> <td>PMT PID 1200</td> </tr> <tr> <td></td> <td>V PID 1109</td> <td>V PID 1209</td> </tr> <tr> <td></td> <td>A PID 1108</td> <td>A PID 1208</td> </tr> <tr> <td></td> <td>Logic number</td> <td>Logic number</td> <td></td> </tr> <tr> <td></td> <td>1 visible</td> <td>0 non-visible</td> <td></td> </tr> </tbody> </table> <p><sup>1)</sup>ON_id (Original_network_id) can be chosen in range 0x0001-0xfe00 (operational network)</p> <p><b>Test procedure:</b></p> <p>In initial phase transport stream carries at least one service. In second phase at least one new “non-visible” data service is added inclusive the required PSI/SI signalization parameters.</p> <ol style="list-style-type: none"> <li>1. Verify that the receiver doesn’t have the service2 in MUX1 already installed.</li> <li>2. Check that the service1 in MUX1 is accessed.</li> <li>3. Add a new “non-visible” data service (Service2 in MUX1) within transport stream             <ol style="list-style-type: none"> <li>a. Verify the service is added in SDT_actual, PAT and PMT.</li> <li>b. Verify the service is added in logical_channel_number_descriptor in NIT_actual</li> </ol> </li> <li>4. Toggle receiver from active mode to standby mode and from standby mode to active mode</li> </ol>				Service1	Service2	Frequency	<b>MUX1</b>	SID 1100	SID 1200	Can be chosen depending of the distribution media.	TS_id 1	S_name Test11	S_name Test21	Network_id 1	S type 1	S type 12	ON_id <sup>1)</sup>	PMT PID 1100	PMT PID 1200		V PID 1109	V PID 1209		A PID 1108	A PID 1208		Logic number	Logic number			1 visible	0 non-visible	
	Service1	Service2	Frequency																															
<b>MUX1</b>	SID 1100	SID 1200	Can be chosen depending of the distribution media.																															
TS_id 1	S_name Test11	S_name Test21																																
Network_id 1	S type 1	S type 12																																
ON_id <sup>1)</sup>	PMT PID 1100	PMT PID 1200																																
	V PID 1109	V PID 1209																																
	A PID 1108	A PID 1208																																
	Logic number	Logic number																																
	1 visible	0 non-visible																																

	<p>5. Verify that the IRD detects the added service2 in MUX1<sup>2</sup> without disturbing end-user and it doesn't store the service2 in MUX1 in the service list.</p> <p><sup>2)</sup> Receiver can inform end-user with a notice e.g. in case of an own OTA service that a new software is available. In case of unmatched OTA service receiver shall not inform addition of a new service.</p> <p><b>Expected result:</b> IRD detects the added "non-visible" data service quasi-statically without end-user disturbance.</p> <p>The "non-visible" data service is not visible in the service list.</p>
<b>Test result(s)</b>	
<b>Conformity</b>	<input type="checkbox"/> OK <input type="checkbox"/> Fault <input type="checkbox"/> Major <input type="checkbox"/> Minor, define fail reason in comments
<b>Comments</b>	If possible describe if fault can be fixed with software update: <input type="checkbox"/> YES <input type="checkbox"/> NO Describe more specific faults and/or other information
<b>Date</b>	<b>Sign</b>

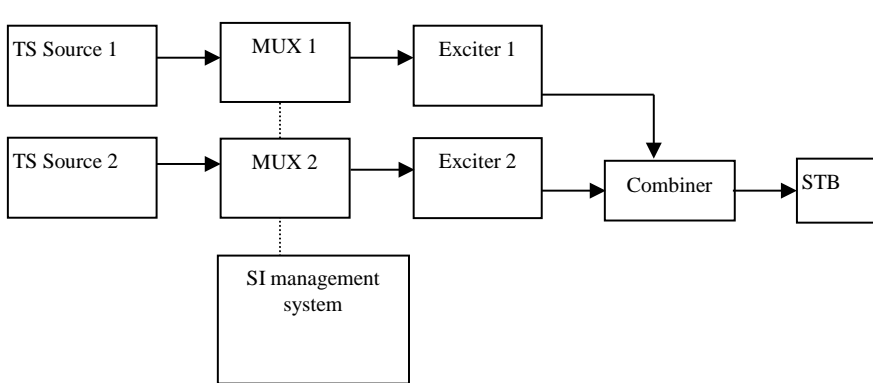
<b>Test Case</b>	<b>Task 14:16 Quasi-static update of service list – services moved between different transport streams</b>																																
<b>Section</b>	NorDig Unified 12.1 and 13.2.4																																
<b>Requirement</b>	This test is an addition to NorDig Unified TestTask 8:26 and Task 8:29.																																
<b>IRD Profile(s)</b>	Basic, IRD, FE																																
<b>Test procedure</b>	<p><b>Purpose of test:</b> To verify that the IRD updates service list quasi-static when one or several services are moved between different transport streams.</p> <p><b>Equipment:</b></p>  <pre> graph LR     TS1[TS Source 1] --&gt; MUX1[MUX 1]     TS2[TS Source 2] --&gt; MUX2[MUX 2]     MUX1 -.-&gt; SI[SI management system]     MUX2 -.-&gt; SI     MUX1 --&gt; Exc1[Exciter 1]     MUX2 --&gt; Exc2[Exciter 2]     Exc1 --&gt; Comb[Combiner]     Exc2 --&gt; Comb     Comb --&gt; STB[STB]     </pre> <table border="1" data-bbox="383 1792 1324 2016"> <thead> <tr> <th></th> <th>Service1</th> <th>Service2</th> <th>Frequency</th> </tr> </thead> <tbody> <tr> <td><b>MUX1</b></td> <td>SID 1100</td> <td>SID 1200</td> <td rowspan="6">Can be chosen depending of the distribution media.</td> </tr> <tr> <td>TS_id 1</td> <td>S_name Test11</td> <td>S_name Test12</td> </tr> <tr> <td>Network_id 1</td> <td>S type 1</td> <td>S type 1</td> </tr> <tr> <td>ON_id <sup>1)</sup></td> <td>PMT PID 1100</td> <td>PMT PID 1200</td> </tr> <tr> <td></td> <td>V PID 1109</td> <td>V PID 1209</td> </tr> <tr> <td></td> <td>A PID 1108</td> <td>A PID 1208</td> </tr> <tr> <td></td> <td>Logic number</td> <td>Logic number</td> </tr> <tr> <td></td> <td>1 visible</td> <td>3 visible</td> <td></td> </tr> </tbody> </table>				Service1	Service2	Frequency	<b>MUX1</b>	SID 1100	SID 1200	Can be chosen depending of the distribution media.	TS_id 1	S_name Test11	S_name Test12	Network_id 1	S type 1	S type 1	ON_id <sup>1)</sup>	PMT PID 1100	PMT PID 1200		V PID 1109	V PID 1209		A PID 1108	A PID 1208		Logic number	Logic number		1 visible	3 visible	
	Service1	Service2	Frequency																														
<b>MUX1</b>	SID 1100	SID 1200	Can be chosen depending of the distribution media.																														
TS_id 1	S_name Test11	S_name Test12																															
Network_id 1	S type 1	S type 1																															
ON_id <sup>1)</sup>	PMT PID 1100	PMT PID 1200																															
	V PID 1109	V PID 1209																															
	A PID 1108	A PID 1208																															
	Logic number	Logic number																															
	1 visible	3 visible																															

<b>MUX2</b>	SID 2100	SID 2200	Can be chosen depending of the distribution media. Not same as for Exciter 1
TS_id 2	S_name Test21	S_name Test22	
Network_id 2	S type 1	S type 1	
ON_id <sup>1)</sup>	PMT PID 2100	PMT PID 2200	
	V PID 2109	V PID 2209	
	A PID 2108	A PID 2208	
	Logic number 2 visible	Logic number 4 visible	

<sup>1)</sup>ON\_id (Original\_network\_id) can be chosen in range 0x0001-0xfe00 (operational network) and it shall be same for both muxes

<sup>2)</sup>Network\_id for DVB-C and DVB-S/S2 IRD tests shall be same in all muxes

**Test procedure:**

1. Verify that the private\_data\_specifier\_descriptor and NorDig\_logic\_channel\_descriptor are signaled in NIT\_actual.
2. Perform a re-initialisation and a channel search.
3. Verify that the services from MUX 1 and MUX2 are located in service list as they are signaled.
4. Fill in the measurement record 1
5. Change following configurations:
  1. remove service "Test11" from MUX1 and add this service to MUX2, rename it to "Test11 new"
  2. remove service "Test21" from MUX2 and add this service to MUX1, rename it to "Test21 new"
6. Toggle between active mode and standby mode.
7. Verify the services are stored at their logical numbers in the service list.
8. Fill in the measurement record 2.

When a move of service happens, its TS\_id and Network\_id change according to configuration in this test, the receiver shall identify the service as new and add it in the service list. When the receiver detects the service with equal LCN is removed, it shall move the service from the last positions in service list to its corresponding position signaled in LCN.

**Expected result:**

Services remain at their signaled logical channel positions after moving them between different transport streams.

**Test result(s)**

Measurement record 1:

TV list	NOK or OK
1 Test11	
2 Test21	
3 Test12	
4 Test22	

Measurement record 2:

TV list	NOK or OK
1 Test11 new	
2 Test21 new	
3 Test12	
4 Test22	

**Conformity**

OK Fault  Major  Minor, define fail reason in comments

**Comments**

If possible describe if fault can be fixed with software update: YES NO  
Describe more specific faults and/or other information

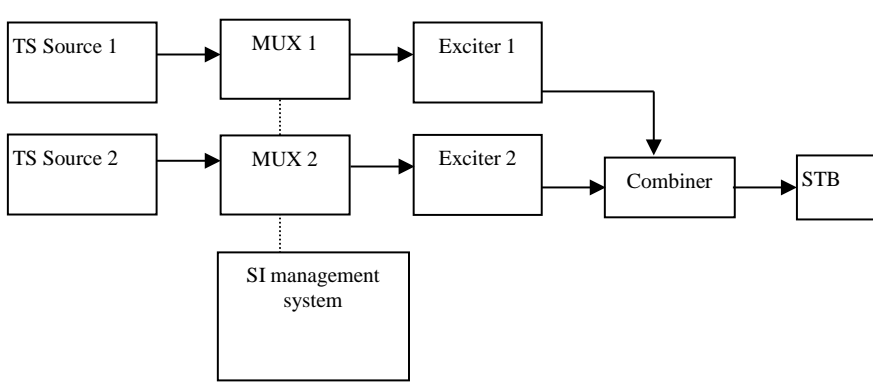

<b>Date</b>		<b>Sign</b>

<b>Test Case</b>	<b>Task 14:17 Quasi-static update of service list – service remove</b>															
<b>Section</b>	NorDig Unified 12.1 and 13.2.4															
<b>Requirement</b>	<p>The IRD shall at least start updating for any changes in the received “quasi-static” SI data, (NIT and SDT i.e. SI that is normally stored in the flash memory for service navigations such as service_name, service_ID, number of services), after it return to active from stand-by mode.</p> <p>... Initiation of update in the Service List that the IRD is not able to perform in the ‘background’ without disturbances or user action/confirmation, shall (only) be made after manual power up or after user selection to an affected service/transport stream (e.g. when re-scanning is needed).</p>															
<b>IRD Profile(s)</b>	Basic, IRD, FE															
<b>Test procedure</b>	<p><b>Purpose of the test:</b> To check that the IRD updates service list quasi-static when a service is removed within transport stream.</p> <p><b>Equipment:</b></p>  <table border="1" style="width: 100%; border-collapse: collapse;"> <thead> <tr> <th></th> <th><b>Service1</b></th> <th><b>Service2</b></th> <th></th> <th><b>Frequency</b></th> </tr> </thead> <tbody> <tr> <td><b>MUX1</b> TS_id 1 Network_id 1 ON_id <sup>1)</sup></td> <td>SID 1100 S_name Test11 S_type 0x01 PMT PID 1100 V PID 1109 A PID 1108 LCN 1 visible</td> <td>SID 1200 S_name Test12 S_type 0x01 PMT PID 1200 V PID 1209 A PID 1208 LCN 2 visible</td> <td></td> <td>Can be chosen depending of the distribution media.</td> </tr> <tr> <td><b>MUX2</b> TS_id 2 Network_id 2 ON_id <sup>1)</sup></td> <td>SID 2100 S_name Test21 S_type 0x01 PMT PID 2100 V PID 2109 A PID 2108 LCN 3 visible</td> <td>SID 2200 S_name Test22 S_type 0x01 PMT PID 2200 V PID 2209 A PID 2208 LCN 4 visible</td> <td>Bouquet SI All information in EIT.</td> <td>Can be chosen depending of the distribution media. Not same as for Exciter 1</td> </tr> </tbody> </table> <p><sup>1)</sup>ON_id (Original_network_id) can be chosen in range 0x0001-0xfe00 (operational network) and it shall be same for both muxes <sup>2)</sup>Network_id for DVB-C and DVB-S/S2 IRD tests shall be same in all muxes</p>		<b>Service1</b>	<b>Service2</b>		<b>Frequency</b>	<b>MUX1</b> TS_id 1 Network_id 1 ON_id <sup>1)</sup>	SID 1100 S_name Test11 S_type 0x01 PMT PID 1100 V PID 1109 A PID 1108 LCN 1 visible	SID 1200 S_name Test12 S_type 0x01 PMT PID 1200 V PID 1209 A PID 1208 LCN 2 visible		Can be chosen depending of the distribution media.	<b>MUX2</b> TS_id 2 Network_id 2 ON_id <sup>1)</sup>	SID 2100 S_name Test21 S_type 0x01 PMT PID 2100 V PID 2109 A PID 2108 LCN 3 visible	SID 2200 S_name Test22 S_type 0x01 PMT PID 2200 V PID 2209 A PID 2208 LCN 4 visible	Bouquet SI All information in EIT.	Can be chosen depending of the distribution media. Not same as for Exciter 1
	<b>Service1</b>	<b>Service2</b>		<b>Frequency</b>												
<b>MUX1</b> TS_id 1 Network_id 1 ON_id <sup>1)</sup>	SID 1100 S_name Test11 S_type 0x01 PMT PID 1100 V PID 1109 A PID 1108 LCN 1 visible	SID 1200 S_name Test12 S_type 0x01 PMT PID 1200 V PID 1209 A PID 1208 LCN 2 visible		Can be chosen depending of the distribution media.												
<b>MUX2</b> TS_id 2 Network_id 2 ON_id <sup>1)</sup>	SID 2100 S_name Test21 S_type 0x01 PMT PID 2100 V PID 2109 A PID 2108 LCN 3 visible	SID 2200 S_name Test22 S_type 0x01 PMT PID 2200 V PID 2209 A PID 2208 LCN 4 visible	Bouquet SI All information in EIT.	Can be chosen depending of the distribution media. Not same as for Exciter 1												

	<p>NOTE: For the terrestrial networks where several transmitters can be received simultaneously, it is important to verify the parameters original_network_id, transport_stream_id and service_id to make a service unique. In cases where original_network_id and transport_stream_id are the same, but the services carried within transport stream differs, network_id can be interpreted to verify if the transport stream belongs to an other region.</p> <p><b>Test procedure:</b></p> <p>In initial phase transport stream carries at least two services. In second phase one service is removed inclusive the required PSI/SI signalization parameters.</p> <ol style="list-style-type: none"> <li>1. Make first time installation of the IRD or verify that all signaled services within transport stream are in the service list.</li> <li>2. Remove Service2 carried within transport stream through MUX1             <ol style="list-style-type: none"> <li>a. Verify the Service2 is removed from SDT_actual, PAT and PMT in MUX1.</li> <li>b. Verify the Service2 is removed from service_list_descriptor in NIT_actual in MUX1.</li> <li>c. Verify the Service2 is removed from SDT_other in MUX2 in case the SDT_other is signaled.</li> </ol> </li> <li>3. Toggle receiver from active mode to standby mode and from standby mode to active mode</li> <li>4. Verify the service removed from the service list.</li> </ol> <p><b>Expected result:</b> IRD automatically removes the service from the service list.</p> <p>NOTE 1: If the removed service is reserved for any reason, e.g. for timer use, the receiver will have a conflict in that time when the removed service is requested. It is receiver manufacture responsibility to handle such a conflict.</p> <p>NOTE 2: In that time when the service is removed from the transport stream and user is watching an other service, displaying of any OSD is not allowed, due to the possibility that the viewer may be disturbed of that, e.g. in case of recording another service</p> <p>NOTE 3: If a user requests a removed service by zapping to that service, an OSD request to remove the service is allowed.</p>
<b>Test result(s)</b>	<p>If possible, mark when the service remove is done:</p> <p><input type="checkbox"/> From active mode to stand-by mode</p> <p><input type="checkbox"/> From stand-by mode to active mode</p> <p>Does the receiver remove the service from the service list if the user is zapping to a removed service:</p> <p><input type="checkbox"/> Yes</p> <p><input type="checkbox"/> No</p>
<b>Conformity</b>	<input type="checkbox"/> <b>OK Fault</b> <input type="checkbox"/> Major <input type="checkbox"/> Minor, define fail reason in comments
<b>Comments</b>	If possible describe if fault can be fixed with software update: <input type="checkbox"/> <b>YES</b> <input type="checkbox"/> <b>NO</b> Describe more specific faults and/or other information
<b>Date</b>	<b>Sign</b>
<b>Test Case</b>	<b>Task 14:18 Quasi-static update of service list from NIT_actual for non-existing multiplexers</b>
<b>Section</b>	NorDig Unified 12.1 and 13.2.4

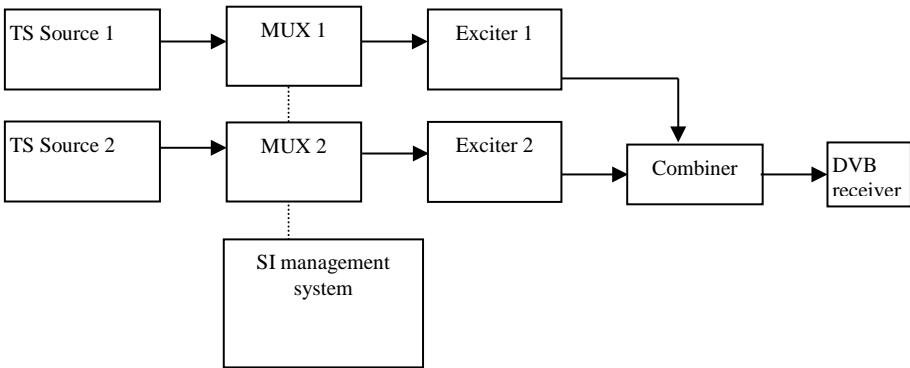
<p><b>Requirement</b></p>	<p>The IRD shall at least start updating for any changes in the received “quasi-static” SI data, (NIT and SDT i.e. SI that is normally stored in the flash memory for service navigations such as service_name, service_ID, number of services), after it return to active from stand-by mode.</p> <p>... Initiation of update in the Service List that the IRD is not able to perform in the ‘background’ without disturbances or user action/confirmation, shall (only) be made after manual power up or after user selection to an affected service/transport stream (e.g. when re-scanning is needed).</p>
<p><b>IRD Profile(s)</b></p>	<p>Basic, IRD, FE</p>
<p><b>Test procedure</b></p>	<p><b>Purpose of test:</b> To verify that the IRD is able to update the service list automatically by doing it quasi-statically or dynamically.</p> <p><b>Equipment:</b></p>  <pre> graph LR     TS1[TS Source 1] --&gt; MUX1[MUX 1]     TS2[TS Source 2] --&gt; MUX2[MUX 2]     MUX1 -.- SI[SI management system]     MUX2 -.- SI     MUX1 --&gt; Exc1[Exciter 1]     MUX2 --&gt; Exc2[Exciter 2]     Exc1 --&gt; Comb[Combiner]     Exc2 --&gt; Comb     Comb --&gt; DVB[DVB receiver]     </pre> <p><b>NOTE:</b> Assumption in the transport stream NIT_actual is that it has not the TS_id signaled for the added multiplexer.</p> <p><b>Test procedure:</b></p> <ol style="list-style-type: none"> <li>1. Set up the system and verify the transport stream contains a NIT_actual with original_network_id in operating range and TS_id=0x1.</li> <li>2. Do a reinstallation of the IRD</li> <li>3. Verify which services IRD has in its service list (and a service from following steps is not stored in the service list.)</li> <li>4. Turn off the IRD</li> <li>5. Add new TS_id in the NIT_actual including a service_list_descriptor and logical_channel_descriptor for at least one service.</li> <li>6. Turn on IRD.</li> <li>7. Verify how (turn on or switch off) the IRD updates the changed data in the service list.</li> <li>8. Fill in the test results how the updates are done.</li> <li>9. Verify the IRD at least displays an information message to end-user stating a new scan is required or do a re-scan in the network.</li> <li>10. Verify that the new service from the new multiplex is added to the service list.</li> </ol> <p><b>Expected result:</b> IRD shall update the service list by doing a scan in case of the service is in a non-existing multiplex (not scanned before).</p>
<p><b>Test result(s)</b></p>	



NorDig

<b>Conformity</b>	<input type="checkbox"/> OK Fault <input type="checkbox"/> Major <input type="checkbox"/> Minor, define fail reason in comments		
<b>Comments</b>	If possible describe if fault can be fixed with software update: <input type="checkbox"/> YES <input type="checkbox"/> NO Describe more specific faults and/or other information		
<b>Date</b>		<b>Sign</b>	

<b>Test Case</b>	<b>Task 14:19 Quasi-static update of service list from NIT_actual for removing a multiplex</b>
------------------	------------------------------------------------------------------------------------------------

<b>Section</b>	NorDig Unified 12.1 and 13.2.4
----------------	--------------------------------

<b>Requirement</b>	<p>The IRD shall at least start updating for any changes in the received “quasi-static” SI data, (NIT and SDT i.e. SI that is normally stored in the flash memory for service navigations such as service_name, service_ID, number of services), after it return to active from stand-by mode.</p> <p>... Initiation of update in the Service List that the IRD is not able to perform in the ‘background’ without disturbances or user action/confirmation, shall (only) be made after manual power up or after user selection to an affected service/transport stream (e.g. when re-scanning is needed).</p>
--------------------	----------------------------------------------------------------------------------------------------------------------------------------------------------------------------------------------------------------------------------------------------------------------------------------------------------------------------------------------------------------------------------------------------------------------------------------------------------------------------------------------------------------------------------------------------------------------------------------------------------------

<b>IRD Profile(s)</b>	Basic, IRD, FE
-----------------------	----------------

<b>Test procedure</b>	<p><b>Purpose of test:</b> To verify that the IRD is able to update the service list automatically by doing it quasi-static.</p> <p><b>Equipment:</b></p> <pre> graph LR     TS1[TS Source 1] --&gt; MUX1[MUX 1]     TS2[TS Source 2] --&gt; MUX2[MUX 2]     MUX1 -.- SI[SI management system]     MUX2 -.- SI     MUX1 --&gt; Exc1[Exciter 1]     MUX2 --&gt; Exc2[Exciter 2]     Exc1 --&gt; Comb[Combiner]     Exc2 --&gt; Comb     Comb --&gt; DVB[DVB receiver]     </pre> <p><b>Test procedure:</b></p> <ol style="list-style-type: none"> <li>1. Set up the system and verify that both transport streams contains identical NIT_actual with original_network_id in operating range</li> <li>2. Do a reinstallation of the IRD</li> <li>3. Verify which services IRD has in its service list (and a service from following steps is not stored in the service list.)</li> <li>4. Select a channel which is located in TS Source 1.</li> <li>5. Turn off the IRD</li> <li>6. Remove TS Source 2 from the NIT_actual including a service_list_descriptor and logical_channel_descriptor and switch off RF.</li> <li>7. Turn on IRD.</li> <li>8. Verify how (turn on or switch off) the IRD updates the changed data in the service list.</li> </ol>
-----------------------	--------------------------------------------------------------------------------------------------------------------------------------------------------------------------------------------------------------------------------------------------------------------------------------------------------------------------------------------------------------------------------------------------------------------------------------------------------------------------------------------------------------------------------------------------------------------------------------------------------------------------------------------------------------------------------------------------------------------------------------------------------------------------------------------------------------------------------------------------------------------------------------------------------------------------------------------------------------------------------------------------------------------------------------------------------------------------------------------------------------------------------------------------------------------------------------------------------------------------------------------------------------

	<p>9. Fill in the test results how the updates are done.</p> <p>10. Verify the IRD at least displays an information message to end-user stating a new scan is required or do a re-scan in the network.</p> <p>11. Verify that services from TS Source 2 are removed from channel list.</p> <p><b>Expected result:</b> IRD shall update the service list by doing a re-scan.</p>
<i>Test result(s)</i>	
<i>Conformity</i>	<input type="checkbox"/> <b>OK Fault</b> <input type="checkbox"/> Major <input type="checkbox"/> Minor, define fail reason in comments
<i>Comments</i>	<p>If possible describe if fault can be fixed with software update: <input type="checkbox"/> <b>YES</b> <input type="checkbox"/> <b>NO</b></p> <p>Describe more specific faults and/or other information</p>
<i>Date</i>	<i>Sign</i>

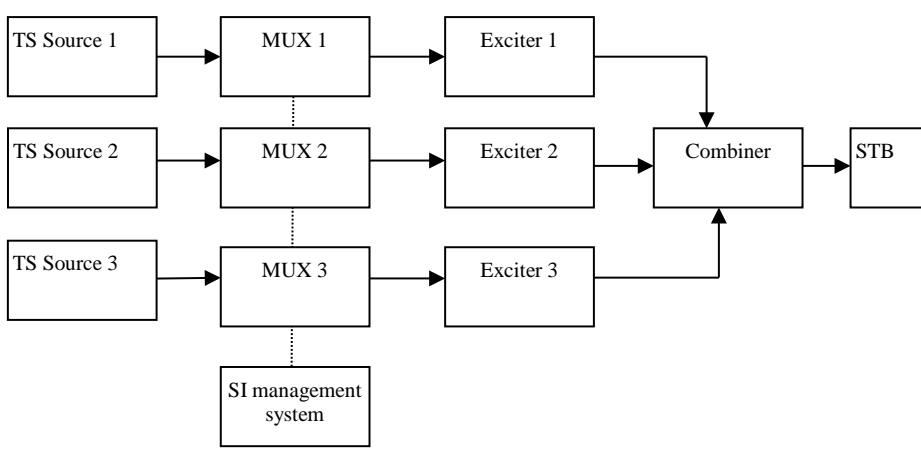
<i>Test Case</i>	<b>Task 14:20 Quasi-static update of NorDig LCN v1</b>
<i>Section</i>	NorDig Unified 12.2.9.1 and 13.2.2
<i>Requirement</i>	<p>NIT descriptors mandatory to receive and interpret if broadcasted:</p> <p>Private_data_specifier_descriptor NorDig channel descriptor</p> <p>Services that are not listed in NorDig Logic_channel_descriptor, shall be displayed in the service list(s) and shall be located last in the list (for that service_type).</p>
<i>IRD Profile(s)</i>	Basic, IRD, FE
<i>Test procedure</i>	<p><b>Purpose of test:</b> To check the support for the private data specifier and NorDig logic channel version 1 descriptors.</p> <p>To verify that the services, which are not listed in NorDig logic_channel_descriptor are displayed last in service list for that service type.</p> <p><b>Equipment:</b></p>  <pre> graph LR     TS1[TS Source 1] --&gt; MUX1[MUX 1]     TS2[TS Source 2] --&gt; MUX2[MUX 2]     TS3[TS Source 3] --&gt; MUX3[MUX 3]     MUX1 -.- SI[SI management system]     MUX2 -.- SI     MUX3 -.- SI     MUX1 --&gt; Exc1[Exciter 1]     MUX2 --&gt; Exc2[Exciter 2]     MUX3 --&gt; Exc3[Exciter 3]     Exc1 --&gt; Comb[Combiner]     Exc2 --&gt; Comb     Exc3 --&gt; Comb     Comb --&gt; STB[STB]   </pre>

	Service1	Service2	Service3	Service3	Frequency
<b>MUX1</b> TS_id 1 Network_id 1 ON_id <sup>1)</sup>	SID 1100 S_name Test11 S type 1 or 22 PMT PID 1100 V PID 1109 A PID 1108 Logic number 1 visible	SID 1200 S_name Test12 S type 12 PMT PID 1200 V PID 1209 A PID 1208 Logic number 0 non-visible	SID 1300 S_name Test13 S type 2 PMT PID 1300 V PID 1309 A PID 1308 Logic number 3 visible	SID 1400 S_name Test14 S type 1 or 22 PMT PID 1400 V PID 1409 A PID 1408 Logic number 0 non-visible	Can be chosen depending of the distribution media.
<b>MUX2</b> TS_id 2 Network_id 2 ON_id <sup>1)</sup>	SID 2100 S_name Test21 S type 1 or 22 PMT PID 2100 V PID 2109 A PID 2108 Logic number 3 visible	SID 2200 S_name Test22 S type 1 or 22 PMT PID 2200 V PID 2209 A PID 2208 Logic number missing	SID 2300 S_name Test23 S type 1 or 22 PMT PID 2300 V PID 2309 A PID 2308 Logic number 98 visible		Can be chosen depending of the distribution media. Not same as for Exciter 1
<b>MUX3</b> TS_id 3 Network_id 3 ON_id <sup>1)</sup>	SID 3100 S_name Test31 S type 1 or 22 PMT PID 3100 V PID 3109 A PID 3108 Logic number 2 visible	SID 3200 S_name Test32 S type 1 or 22 PMT PID 3200 V PID 3209 A PID 3208 Logic number 4 visible	SID 3300 S_name Test33 S type 1 or 22 PMT PID 3300 V PID 3309 A PID 3308 Logic number 5 visible	SID 3400 S_name Test34 S type 1 or 22 PMT PID 3400 V PID 3409 A PID 3408 Logic number 10 visible	Can be chosen depending of the distribution media. Not same as for Exciter 1 and 2

<sup>1)</sup> ON\_id (Original\_network\_id) can be chosen in range 0x0001-0xfe00 (operational network) and it shall be same for all muxes

<sup>2)</sup> Network\_id for DVB-C and DVB-S/S2 IRD tests shall be same in all muxes

**Test procedure:**

- Verify that the private\_data\_specifier\_descriptor and NorDig\_channel\_descriptor are signaled in NIT\_actual.
- If needed perform a re-initialisation and a channel search.
- Verify that the services from MUX 1, MUX2 and MUX3 are located in service list as they are signaled.
- Fill in the measurement record 1
- Verify the service2 in MUX2 is listed last in the TV service list.
- Change the content of the following logical\_channel\_descriptors
  - service2 in MUX1: from 0 to 1 (visible)
  - service4 in MUX1: from 0 to 4 (visible)
  - service1 in MUX2: from 3 to 99 (remains visible)
  - service2 in MUX3: from 4 to 5 (remains visible)
  - service3 in MUX3: from 5 to 0 (non-visible)
  - service4 in MUX3: from 10 to 3 (remains visible)
- Toggle between active mode and standby mode.
- Verify the services are stored at their logical numbers in the service list.
- Fill in the measurement record 2.

**Expected result:**  
 Services are stored in correct type of service lists and in their signaled logical channel positions.  
 Service2 in MUX2 is listed last in the TV service list.

<b>Test result(s)</b>	Measurement record 1							
	<table border="1"> <tr> <td>TV list</td> <td>Radio list</td> <td>Data list</td> <td><b>NOK or OK</b></td> </tr> <tr> <td>1 Test11</td> <td>3 Test13</td> <td></td> <td></td> </tr> </table>	TV list	Radio list	Data list	<b>NOK or OK</b>	1 Test11	3 Test13	
TV list	Radio list	Data list	<b>NOK or OK</b>					
1 Test11	3 Test13							

	<p>2 Test31 3 Test21 4 Test32 5 Test33 10 Test34 98 Test23 99 Test22</p> <p>Measurement record 2</p> <table border="1"> <thead> <tr> <th>TV list</th> <th>Radio list</th> <th>Data list</th> <th>NOK or OK</th> </tr> </thead> <tbody> <tr> <td>1 Test11</td> <td>3 Test13</td> <td>1 Test12</td> <td></td> </tr> <tr> <td>2 Test31</td> <td></td> <td></td> <td></td> </tr> <tr> <td>3 Test34</td> <td></td> <td></td> <td></td> </tr> <tr> <td>4 Test14</td> <td></td> <td></td> <td></td> </tr> <tr> <td>5 Test32</td> <td></td> <td></td> <td></td> </tr> <tr> <td>98 Test23</td> <td></td> <td></td> <td></td> </tr> <tr> <td>99 Test21</td> <td></td> <td></td> <td></td> </tr> <tr> <td>100 Test22</td> <td></td> <td></td> <td></td> </tr> </tbody> </table>	TV list	Radio list	Data list	NOK or OK	1 Test11	3 Test13	1 Test12		2 Test31				3 Test34				4 Test14				5 Test32				98 Test23				99 Test21				100 Test22			
TV list	Radio list	Data list	NOK or OK																																		
1 Test11	3 Test13	1 Test12																																			
2 Test31																																					
3 Test34																																					
4 Test14																																					
5 Test32																																					
98 Test23																																					
99 Test21																																					
100 Test22																																					
<b>Conformity</b>	<input type="checkbox"/> OK Fault <input type="checkbox"/> Major <input type="checkbox"/> Minor, define fail reason in comments																																				
<b>Comments</b>	If possible describe if fault can be fixed with software update: <input type="checkbox"/> YES <input type="checkbox"/> NO Describe more specific faults and/or other information																																				
<b>Date</b>	<b>Sign</b>																																				

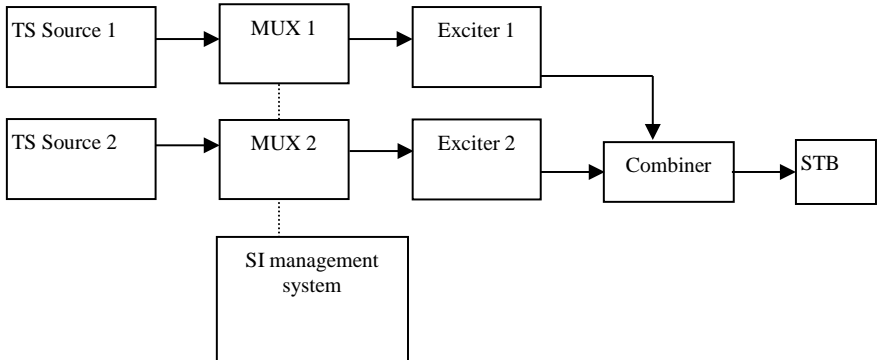
<b>Test Case</b>	<b>Task 14:21 Quasi-static update of NorDig LCN v2</b>
<b>Section</b>	NorDig Unified 12.2.9.2
<b>Requirement</b>	NIT descriptors mandatory to receive and interpret if broadcasted:  Private_data_specifier_descriptor NorDig logical_channel_descriptor v2
<b>IRD Profile(s)</b>	Basic, IRD, FE
<b>Test procedure</b>	<p><b>Purpose of test:</b> To check the support for the private data specifier and NorDig logic channel version 2 descriptors.</p> <p><b>Equipment:</b></p>  <pre> graph LR     TS1[TS Source 1] --&gt; MUX1[MUX 1]     TS2[TS Source 2] --&gt; MUX2[MUX 2]     MUX1 -.- SI[SI management system]     MUX2 -.- SI     MUX1 --&gt; Exc1[Exciter 1]     MUX2 --&gt; Exc2[Exciter 2]     Exc1 --&gt; Comb[Combiner]     Exc2 --&gt; Comb     Comb --&gt; STB[STB]           </pre>

	Service1	Service2	Service3	Frequency
<b>MUX1</b> TS_id 1 Network_id 1 ON_id <sup>1)</sup>	SID 1100 S_name Test11 S type 1 PMT PID 1100 V PID 1109 A PID 1108 LCN Ver.2 1 visible	SID 1200 S_name Test12 S type 12 PMT PID 1200 V PID 1209 A PID 1208 LCN Ver.2 0 non-visible	SID 1300 S_name Test13 S type 2 PMT PID 1300 V PID 1309 A PID 1308 LCN Ver.2 3 visible	Can be chosen depending of the distribution media.
<b>MUX2</b> TS_id 2 Network_id 2 ON_id <sup>1)</sup>	SID 2100 S_name Test21 S type 1 PMT PID 2100 V PID 2109 A PID 2108 LCN Ver.2 3 visible	SID 2200 S_name Test22 S type 1 PMT PID 2200 V PID 2209 A PID 2208 LCN Ver.2 missing	SID 2300 S_name Test23 S type 1 PMT PID 2300 V PID 2309 A PID 2308 LCN Ver.2 98 visible	Can be chosen depending of the distribution media. Not same as for Exciter 1

<sup>1)</sup>ON\_id (Original\_network\_id) can be chosen in range 0x0001-0xfe00 (operational network) and it shall be same for both muxes

<sup>2)</sup>Network\_id for DVB-C and DVB-S/S2 IRD tests shall be same in all muxes

For satellite networks the channel lists represented in tables below are valid due to the capability to receive services within one and same ON\_id in different countries where even different country\_settings in receiver are relevant. The LCN is equal in all different channel lists IDs.

For cable and terrestrial networks, a subset of channel lists is required as long as one and same ON\_id is in concern. Transmissions in these networks are not normally dedicated for receivers with different country settings. Therefore, one channel list is enough to test requirement in this test.

MUX1:

Channel_list_ID	Channel list name	Country_code
1	ListSWE	SWE
2	ListFIN	FIN
3	ListNOR	NOR
4	ListDNK	DNK
5	ListICE	ICE

MUX2:

Channel_list_ID	Channel list name	Country_code
1	ListSWE	SWE
2	ListFIN	FIN
3	ListNOR	NOR
4	ListDNK	DNK
5	ListICE	ICE

**Test procedure:**

1. Verify that the private\_data\_specifier\_descriptor and NorDig\_channel\_descriptor are signaled in NIT\_actual.
2. If needed perform a re-initialisation and a channel search.
3. Verify that the services from MUX 1 and MUX2 are located in service list as they are signaled.



	<ol style="list-style-type: none"> <li>4. Fill in the measurement record 1</li> <li>5. Verify the service2 in MUX2 is listed last in the TV service list.</li> <li>6. Change the content of the following logical_channel_descriptors             <ol style="list-style-type: none"> <li>a. service1 in MUX2: from 3 to 99 (remains visible)</li> <li>b. service2 in MUX1: from 0 to 1 (visible)</li> </ol> </li> <li>7. Toggle between active mode and standby mode.</li> <li>8. Verify the services are stored at their logical numbers in the service list.</li> <li>9. Fill in the measurement record 2.</li> </ol> <p><b>Expected result:</b>            Services are stored in correct categories of service lists, with correct channel list name, and in their signaled logical channel positions.            Service2 in MUX2 is listed last in the TV service list.            Quasi-static update of service list is performed.</p>																								
<i>Test result(s)</i>	<p>Measurement record 1</p> <table border="1" style="width: 100%; border-collapse: collapse;"> <tr> <td style="width: 80%;">Selected country settings in receiver(for information)</td> <td></td> </tr> <tr> <td>Selected channel list name (for information)</td> <td></td> </tr> </table> <table border="1" style="width: 100%; border-collapse: collapse; margin-top: 10px;"> <thead> <tr> <th style="width: 33%;">TV list</th> <th style="width: 33%;">Radio list</th> <th style="width: 17%;">Data list</th> <th style="width: 17%;">NOK or OK</th> </tr> </thead> <tbody> <tr> <td>1 Test11 3 Test21 98 Test23 99 Test22</td> <td>3 Test13</td> <td></td> <td></td> </tr> </tbody> </table> <p>Measurement record 2</p> <table border="1" style="width: 100%; border-collapse: collapse;"> <tr> <td style="width: 80%;">Selected country settings in receiver (for information)</td> <td></td> </tr> <tr> <td>Selected channel list name (for information)</td> <td></td> </tr> </table> <table border="1" style="width: 100%; border-collapse: collapse; margin-top: 10px;"> <thead> <tr> <th style="width: 33%;">TV list</th> <th style="width: 33%;">Radio list</th> <th style="width: 17%;">Data list</th> <th style="width: 17%;">NOK or OK</th> </tr> </thead> <tbody> <tr> <td>1 Test11 98 Test23 99 Test21 100 Test22</td> <td>3 Test13</td> <td>1 Test12</td> <td></td> </tr> </tbody> </table>	Selected country settings in receiver(for information)		Selected channel list name (for information)		TV list	Radio list	Data list	NOK or OK	1 Test11 3 Test21 98 Test23 99 Test22	3 Test13			Selected country settings in receiver (for information)		Selected channel list name (for information)		TV list	Radio list	Data list	NOK or OK	1 Test11 98 Test23 99 Test21 100 Test22	3 Test13	1 Test12	
Selected country settings in receiver(for information)																									
Selected channel list name (for information)																									
TV list	Radio list	Data list	NOK or OK																						
1 Test11 3 Test21 98 Test23 99 Test22	3 Test13																								
Selected country settings in receiver (for information)																									
Selected channel list name (for information)																									
TV list	Radio list	Data list	NOK or OK																						
1 Test11 98 Test23 99 Test21 100 Test22	3 Test13	1 Test12																							
<i>Conformity</i>	<input type="checkbox"/> <b>OK Fault</b> <input type="checkbox"/> Major <input type="checkbox"/> Minor, define fail reason in comments																								
<i>Comments</i>	If possible describe if fault can be fixed with software update: <input type="checkbox"/> <b>YES</b> <input type="checkbox"/> <b>NO</b> Describe more specific faults and/or other information																								
<i>Date</i>	<table border="1" style="width: 100%; border-collapse: collapse;"> <tr> <td style="width: 50%;"></td> <td style="width: 50%; text-align: center;"><i>Sign</i></td> </tr> </table>		<i>Sign</i>																						
	<i>Sign</i>																								

## 2.15 Task 15: PVR Functionality

<b>Test Case</b>	<b>Task 15:1 Recording File System</b>
<b>Section</b>	NorDig Unified 14.2
<b>Requirement</b>	<p>The NorDig PVR shall at all times keep a file system of the PVR's recordings and make them available upon request for the user to select and playback.</p> <p>The user shall be able to list the recordings as:</p> <ul style="list-style-type: none"> <li>all recordings, as ordered by date&amp;time</li> </ul> <p>For all recordings that have been programmed via the ESG or EPG, each recorded item in the NorDig PVR's list of recordings shall display for the user at least information about the recorded event's date of recording and event_name extracted from EIT data during the recording. If no event information is available for a specific recording then the service_name shall be used. For manual recording that span several events, it is recommended to use the service_name instead.</p>
<b>IRD Profile(s)</b>	Basic, PVR, IRD, FE
<b>Test procedure</b>	<p><b>Purpose of test:</b> To verify that IRD recordings file system is according requirements</p> <p><b>Test procedure:</b> This is a general requirement and will be tested in the following test tasks.</p>

<b>Test Case</b>	<b>Task 15:2 Recording capacity</b>
<b>Section</b>	NorDig Unified 14.2.2
<b>Requirement</b>	<p>The NorDig PVR shall be able to indicate its momentary available recording capacity. The basis for the indication shall be explained in the instruction manual and should be in terms of capacity (e.g. GB), percentage or time (e.g. hours).</p> <p>The Manufacture shall clearly state the recording capacity for the NorDig PVR in marketing specification and in the instruction manual. It shall as a minimum be specified in terms of bytes (like GigaByte, GB etc).</p>
<b>IRD Profile(s)</b>	Basic, PVR, IRD, FE
<b>Test procedure</b>	<p><b>Purpose of test:</b> To verify that IRD indicates the capacity of the mass storage.</p> <p><b>Equipment:</b> IRD Under test</p> <p><b>Test procedure:</b></p> <ol style="list-style-type: none"> <li>Verify that the recording capacity is presented in the IRD menu.</li> <li>Verify that the instruction manual states clearly the recording capacity.</li> </ol> <p><b>Expected results:</b> The IRD and the instruction manual indicates the recording capacity.</p>
<b>Test result(s)</b>	
<b>Conformity</b>	<input type="checkbox"/> OK <input type="checkbox"/> Fault <input type="checkbox"/> Major <input type="checkbox"/> Minor, define fail reason in comments
<b>Comments</b>	If possible describe if fault can be fixed with software update: <input type="checkbox"/> YES <input type="checkbox"/> NO Describe more specific faults and/or other information
<b>Date</b>	<b>Sign</b>

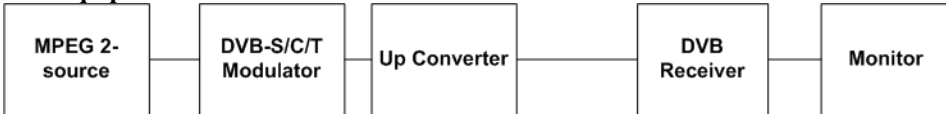
<b>Test Case</b>	<b>Task 15:3 Deletion of the recordings</b>	
<b>Section</b>	NorDig Unified 14.2.3	
<b>Requirement</b>	<p>The user shall be able to manually delete any recorded event in the NorDig PVR by deleting one recording at the time.</p> <p>The NorDig PVR shall have a mode (set as factory default) where the NorDig PVR shall ask for user confirmation before deletion of recordings (i.e. the NorDig PVR may in addition have alternative mode where the NorDig PVR will delete recordings without any extra confirmation).</p>	
<b>IRD Profile(s)</b>	Basic, PVR, IRD, FE	
<b>Test procedure</b>	<p><b>Purpose of test:</b> To verify that receiver that the IRD can delete PVR content.</p> <p><b>Test Equipment:</b></p>  <pre> graph LR     A[MPEG 2-source] --- B[DVB-S/C/T Modulator]     B --- C[Up Converter]     C --- D[DVB Receiver]     D --- E[Monitor] </pre> <p><b>Test procedure:</b></p> <ol style="list-style-type: none"> <li>1. Open the Receivers PVR/PDR content menu.</li> <li>2. Select one recorded program and delete it.</li> <li>3. Verify that the content is removed and PVR/PDR storage is freed.</li> <li>4. Verify that the IRD has a function that removes all recordings from the mass storage.</li> </ol> <p><b>Expected results:</b> The receiver shall handle deletion of the recorded content.</p>	
<b>Test result(s)</b>		
<b>Conformity</b>	<input type="checkbox"/> OK Fault <input type="checkbox"/> Major <input type="checkbox"/> Minor, define fail reason in comments	
<b>Comments</b>	If possible describe if fault can be fixed with software update: <input type="checkbox"/> YES <input type="checkbox"/> NO Describe more specific faults and/or other information	
<b>Date</b>		<b>Sign</b>

<b>Test Case</b>	<b>Task 15:4 Failed and incomplete recordings</b>	
<b>Section</b>	NorDig Unified 14.2.4	
<b>Requirement</b>	The NorDig PVR shall have a mechanism for informing the user of failed or incomplete (partial) recordings. For incomplete (partial) recordings it should inform the user how much of the booked event has not been successfully recorded.	
<b>IRD Profile(s)</b>	Basic, PVR, IRD, FE	

<b>Test procedure</b>	<p><b>Purpose of test:</b> To verify that IRD handles the failed and incomplete recordings according requirements.</p> <p><b>Equipment:</b> IRD Under test</p> <p><b>Test procedure:</b></p> <ol style="list-style-type: none"> <li>1. Schedule a recording.</li> <li>2. Disconnect IRD from mains before the start time of the recording.</li> <li>3. Re-connect IRD to mains after the end time of the recording.</li> <li>4. Verify that the IRD indicates the recording has failed.</li> </ol> <p>Incomplete recordings will be tested in test cases below.</p>
<b>Test result(s)</b>	
<b>Conformity</b>	<input type="checkbox"/> <b>OK</b> <input type="checkbox"/> <b>Fault</b> <input type="checkbox"/> Major <input type="checkbox"/> Minor, define fail reason in comments
<b>Comments</b>	If possible describe if fault can be fixed with software update: <input type="checkbox"/> <b>YES</b> <input type="checkbox"/> <b>NO</b> Describe more specific faults and/or other information
<b>Date</b>	<i>Sign</i>

	<b>Task 15:5 File system intact after update</b>
<b>Section</b>	NorDig Unified 14.2.6
<b>Requirement</b>	The NorDig PVR's file systems of recorded events shall be intact after <ul style="list-style-type: none"> <li>• updating of the PVR IRD's System Software and/or</li> <li>• updating of CA system and/or</li> <li>• re-installation or update of installed services</li> </ul>
<b>IRD Profile(s)</b>	Basic, PVR, IRD, FE
<b>Test procedure</b>	<p><b>Purpose of test:</b> To verify that IRD file system is intact after system update, CA system update and/or re-installation or update of the installed services</p> <p><b>Equipment:</b></p> <ul style="list-style-type: none"> <li>• IRD Under test</li> <li>• Test stream</li> </ul> <p><b>Preparation for the test:</b></p> <ol style="list-style-type: none"> <li>1. Perform recordings to the IRD mass media.</li> <li>2. View some of the recordings.</li> <li>3. List the content on the mass media.</li> </ol> <p><b>Test procedure:</b></p> <ol style="list-style-type: none"> <li>1. Perform a SW update (for example, during SSU update test tasks).</li> <li>2. Verify that all expected recordings on the IRD mass media are available after the SW update.</li> <li>3. Perform a CA system update: <ol style="list-style-type: none"> <li>a. IRD with Common Interface: Change the CA module to another.</li> <li>b. IRD with integrated CA system: Manufacturer describe the procedure</li> </ol> </li> <li>4. Verify that all expected recordings on the IRD mass media are available after the CA system update.</li> <li>5. Perform factory reset and new installation of the IRD</li> <li>6. Verify that all expected recordings on the IRD mass media are available after the new installation.</li> </ol>

	<b>Expected result:</b> The file system is intact after a software update.	
<b>Test result(s)</b>	Measurement record	
	<b>Test point</b>	<b>Result OK/NOK</b>
	Recordings are available after SW update	
	Recordings are available after CA system update	
	Recordings are available after IRD re-installation	
<b>Conformity</b>	<input type="checkbox"/> <b>OK</b> <input type="checkbox"/> <b>Fault</b> <input type="checkbox"/> Major <input type="checkbox"/> Minor, define fail reason in comments	
<b>Comments</b>	If possible describe if fault can be fixed with software update: <input type="checkbox"/> <b>YES</b> <input type="checkbox"/> <b>NO</b> Describe more specific faults and/or other information	
<b>Date</b>		<b>Sign</b>

	<b>Task 15:6 Limitations in recorded content – no extraction</b>	
<b>Section</b>	NorDig Unified 14.2.7	
<b>Requirement</b>	For protected content (unless otherwise specified by the relevant network/Operator), it shall not be possible to extract or output content from the NorDig PVR in un-protected format, therefore all recordings shall be stored in a protected format not easy to extract by the user.	
<b>IRD Profile(s)</b>	Basic, PVR, IRD, FE	
<b>Test procedure</b>	<p><b>Purpose of test:</b> To verify that IRD's recorded content is not extractable to the user</p> <p><b>Equipment:</b> IRD Under test</p> <p><b>Test procedure:</b></p> <ol style="list-style-type: none"> <li>1. Make sure that IRD has some recorded content</li> <li>2. Verify that the content is not extractable in un-protected format</li> </ol> <p><b>Expected results:</b> The IRD shall protect the content on mass storage</p>	
<b>Test result(s)</b>		
<b>Conformity</b>	<input type="checkbox"/> <b>OK</b> <input type="checkbox"/> <b>Fault</b> <input type="checkbox"/> Major <input type="checkbox"/> Minor, define fail reason in comments	
<b>Comments</b>	If possible describe if fault can be fixed with software update: <input type="checkbox"/> <b>YES</b> <input type="checkbox"/> <b>NO</b> Describe more specific faults and/or other information	
<b>Date</b>		<b>Sign</b>

	<b>Task 15:7 Limitations in recorded content – downscaling of the HD content to the removable media</b>	
<b>Section</b>	NorDig Unified 14.2.7	
<b>Requirement</b>	NorDig PVRs' using standardised removable media, such as DVD or Blu-ray for recording of protected content shall downscale any HD content to SD resolution (maximum 720x576) before storing it to the removable media. HD content may be recorded in its original resolution if the recording retains the original broadcast scrambling or any other local device scrambling approved by the Network/Operator.	
<b>IRD Profile(s)</b>	Basic, PVR, IRD, FE	



<b>Test procedure</b>	<p><b>Purpose of test:</b> To verify that IRD's recorded content is downscaled to standardized removable media.</p> <p><b>Equipment:</b> IRD Under test</p> <p>This test is applicable only for NorDig PVR IRDs that are able to store the content to a standardized removable media, such as DVD or Blu-ray disc.</p> <p><b>Test procedure:</b></p> <ol style="list-style-type: none"> <li>Record HD content to a standardized media.</li> <li>Verify that the content is recorded as downscaled to SD format.</li> </ol> <p><b>Expected results:</b> The IRD shall downscale the content on removable media.</p>
<b>Test result(s)</b>	
<b>Conformity</b>	<input type="checkbox"/> <b>OK</b> <input type="checkbox"/> <b>Fault</b> <input type="checkbox"/> Major <input type="checkbox"/> Minor, define fail reason in comments
<b>Comments</b>	If possible describe if fault can be fixed with software update: <input type="checkbox"/> <b>YES</b> <input type="checkbox"/> <b>NO</b> Describe more specific faults and/or other information
<b>Date</b>	<b>Sign</b>

	<b>Task 15:8 Disk Management</b>
<b>Section</b>	NorDig Unified 14.2.8
<b>Requirement</b>	The NorDig PVR shall have appropriate disk management (including de-fragmentation handling for Hard Disk Drive based PVRs) to minimise need for re-formatting disk during its lifetime.
<b>IRD Profile(s)</b>	Basic, PVR, IRD, FE
<b>Test procedure</b>	<p><b>Purpose of test:</b> To verify that IRD has the disk management function</p> <p><b>Equipment:</b> IRD Under test</p> <p><b>Test procedure:</b></p> <ol style="list-style-type: none"> <li>Verify that the IRD has the disk management and de-fragmentation function</li> </ol> <p><b>Expected results:</b> The IRD has the disk management function.</p>
<b>Test result(s)</b>	
<b>Conformity</b>	<input type="checkbox"/> <b>OK</b> <input type="checkbox"/> <b>Fault</b> <input type="checkbox"/> Major <input type="checkbox"/> Minor, define fail reason in comments
<b>Comments</b>	If possible describe if fault can be fixed with software update: <input type="checkbox"/> <b>YES</b> <input type="checkbox"/> <b>NO</b> Describe more specific faults and/or other information
<b>Date</b>	<b>Sign</b>

	<b>Task 15:9 General PVR recording – bitrates</b>
<b>Section</b>	NorDig Unified 14.3.1
<b>Requirement</b>	The NorDig PVR shall as a minimum support recording up to 20 Mbps per (SD) service and shall as a minimum support recording up to 30 Mbps per (HD) service. The NorDig PVR shall be able to record for at least 60 minutes with the above transmission figures.
<b>IRD Profile(s)</b>	Basic, PVR, IRD, FE

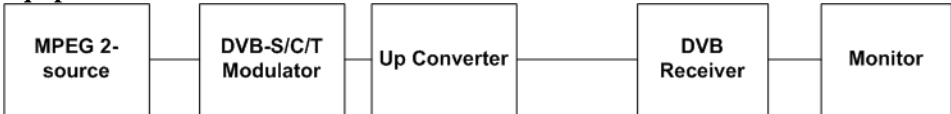
<b>Test procedure</b>	<p><b>Purpose of test:</b> To verify that IRD meet with the general requirements</p> <p><b>Equipment:</b></p>  <p>Test stream with SD service of 20 Mbps bit rate Test stream with HD service of 30 Mbps bit rate</p> <p><b>Test procedure:</b></p> <ol style="list-style-type: none"> <li>1. Select a SD service with 20 Mbps bit rate.</li> <li>2. Start recording for duration of one hour.</li> <li>3. Select a HD service with 30 Mbps bit rate.</li> <li>4. Start recording for duration of one hour.</li> <li>5. Verify that the recordings are performed correctly.</li> </ol> <p><b>Expected results:</b> The IRD is capable of recording with the required service bitrate.</p>						
<b>Test result(s)</b>	<p>Measurement record</p> <table border="1"> <thead> <tr> <th>Test point</th> <th>Result OK/NOK</th> </tr> </thead> <tbody> <tr> <td>SD content, bitrate up to 20Mbps can be recorded and viewed</td> <td></td> </tr> <tr> <td>HD content, bitrate up to 30Mbps can be recorded and viewed</td> <td></td> </tr> </tbody> </table>	Test point	Result OK/NOK	SD content, bitrate up to 20Mbps can be recorded and viewed		HD content, bitrate up to 30Mbps can be recorded and viewed	
Test point	Result OK/NOK						
SD content, bitrate up to 20Mbps can be recorded and viewed							
HD content, bitrate up to 30Mbps can be recorded and viewed							
<b>Conformity</b>	<input type="checkbox"/> <b>OK</b> <input type="checkbox"/> <b>Fault</b> <input type="checkbox"/> Major <input type="checkbox"/> Minor, define fail reason in comments						
<b>Comments</b>	<p>If possible describe if fault can be fixed with software update: <input type="checkbox"/> <b>YES</b> <input type="checkbox"/> <b>NO</b></p> <p>Describe more specific faults and/or other information</p>						
<b>Date</b>	<table border="1"> <tr> <td style="width: 50%;"></td> <td style="width: 20%;"><i>Sign</i></td> <td style="width: 30%;"></td> </tr> </table>		<i>Sign</i>				
	<i>Sign</i>						

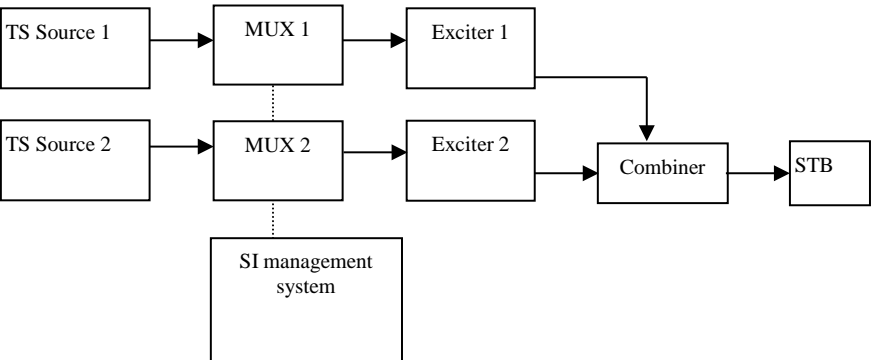
	<b>Task 15:10 General PVR recording – service types</b>													
<b>Section</b>	NorDig Unified 14.3.1 and 14.3.9													
<b>Requirement</b>	The NorDig PVR shall be able to record all supported service types (TV, radio etc) and its components (as described in NorDig Unified 14.3.9)													
<b>IRD Profile(s)</b>	Basic, PVR, IRD, FE													
<b>Test procedure</b>	<p><b>Purpose of test:</b> To verify that IRD record and plays all service types and the components in the service</p> <p><b>Equipment:</b></p>  <table border="1" style="width: 100%; margin-top: 10px;"> <thead> <tr> <th style="width: 25%;"></th> <th style="width: 25%;">Service1</th> <th style="width: 25%;">Service2</th> <th style="width: 25%;">Service3</th> <th style="width: 25%;">Frequency</th> </tr> </thead> <tbody> <tr> <td> </td> <td> </td> <td> </td> <td> </td> <td> </td> </tr> </tbody> </table>					Service1	Service2	Service3	Frequency					
	Service1	Service2	Service3	Frequency										

	<b>MUX1</b> TS_id 1 Network_id 1 ON_id <sup>1)</sup>	SID 1100 Service type 0x01 S_name Test11 PMT PID 1100 V PID 1109 A PID 1108 LCD: 1 visible Encrypted	SID 1200 Service type 0x02 S_name Test12 PMT PID 1200  A PID 1208 LCD: 2 visible Clear	SID 1300 Service type 0x0C S_name Test13 PMT PID 1300 V PID 1309 A PID 1308 LCD: 3 visible Clear	Can be chosen depending of the distribution media
	<b>MUX2</b> TS_id 2 Network_id 2 <sup>2)</sup> ON_id <sup>1)</sup>	SID 2100 Service type 0x16 S_name Test21 PMT PID 2100 V PID 2109 A PID 2108 LCD: 4 visible Clear	SID 2200 Service type 0x19 S_name Test22 PMT PID 2200 V PID 2209 A PID 2208 LCD: 5 visible Clear	SID 2300 Service type 0x0A S_name Test23 PMT PID 2300  A PID 2308 LCD: 6 visible Clear	Can be chosen depending of the distribution media
<p><sup>1)</sup> ON_id (Original_network_id) can be chosen in range 0x0001-0xfe00 (operational network) and it shall be same for both muxes and it shall be same for both muxes</p> <p><sup>2)</sup> Network_id for DVB-C and DVB-S/S2 IRD tests shall be same in all muxes</p> <p>Channel list ID is set to 1 and country_code according to country settings in the receiver.</p> <p>Services in MUX1 are using MPEG-2 video and MPEG1 LII audio.</p> <p>Services in MUX2 are allowed only use advanced coded video and audio, with other words MPEG-4 AVC video and HE-AAC or E-AC-3 audio.</p> <p>Services may contain multiple audio and subtitling tracks and teletext.</p> <p><b>Test procedure:</b></p> <ol style="list-style-type: none"> <li>1. Perform factory reset and new installation of the IRD.</li> <li>2. Verify the IRD installs the channels to appropriate service lists.</li> <li>3. Perform a recording, e.g.5 min, on each service.</li> <li>4. Play back the recordings.</li> <li>5. Verify that the IRD plays back the recordings correctly and all components are available in the recording.</li> </ol> <p><b>Expected results:</b></p> <p>The IRD records and plays the complete service.</p>					
<b>Test result(s)</b>	<b>Service name</b>	<b>Service type</b>			<b>Result OK/NOK</b>
	Test11	Digital television service (0x01)			
	Test12	Digital radio sound service (0x02)			
	Test13	Data broadcast service (0x0C)			
	Test21	H.264/AVC SD digital television service (0x16)			
	Test22	H.264/AVC SD digital television service (0x19)			
	Test23	Advanced codec digital radio sound service (0x0A)			
<b>Conformity</b>	<input type="checkbox"/> <b>OK</b> <input type="checkbox"/> <b>Fault</b> <input type="checkbox"/> Major <input type="checkbox"/> Minor, define fail reason in comments				
<b>Comments</b>	If possible describe if fault can be fixed with software update: <input type="checkbox"/> <b>YES</b> <input type="checkbox"/> <b>NO</b> Describe more specific faults and/or other information				
<b>Date</b>		<b>Sign</b>			

	<b>Task 15:11 ESG/EPG recording programming – individual events without CRID</b>
<b>Section</b>	NorDig Unified 14.3.2
<b>Requirement</b>	The NorDig PVR shall make it possible for the user to select individual events and

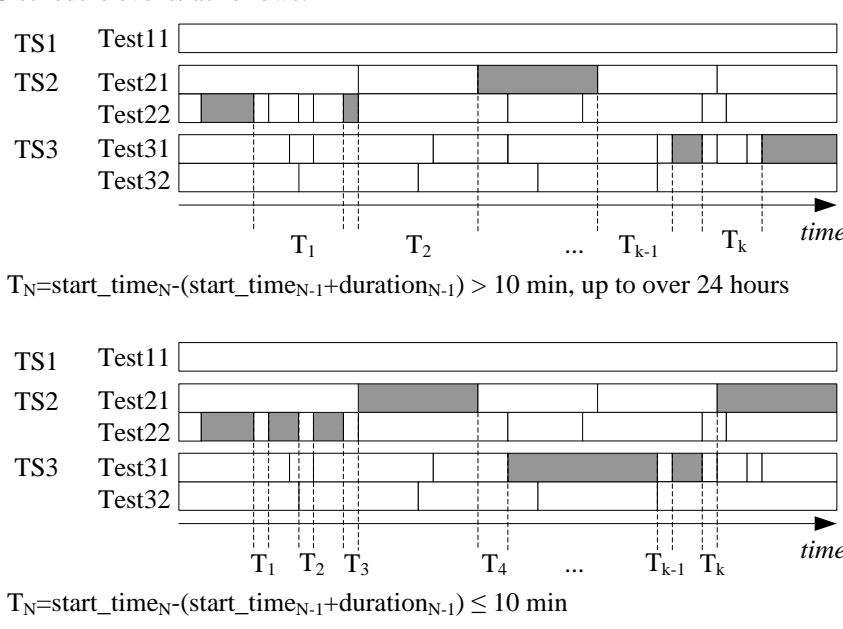

	series to be recorded from the ESG or EPG display (based on information from EIT data).						
<b>IRD Profile(s)</b>	Basic, PVR, IRD, FE						
<b>Test procedure</b>	<p><b>Purpose of test:</b> To verify that the IRD is able to handle several scheduled recordings (manual and EPG scheduled) in on mode. To verify that the IRD is able to wake up from standby to perform scheduled recordings and set itself back into the originating power state after the scheduled recordings have been completed.</p> <p><b>Equipment:</b> Live network or a test network of 3 MUX (tbd) is used for this test. ESG schedule events as follows:</p>  <p><b>Test procedure:</b></p> <ol style="list-style-type: none"> <li>Schedule several events from ESG/EPG for recording as follows:             <ol style="list-style-type: none"> <li>Events with a long time gap (<math>&gt; 10</math> min) between the events</li> <li>Events with a short time gap (<math>\leq 10</math> min) between the events</li> </ol> </li> <li>Take note on/list the scheduled events (event name, start time, duration, service).</li> <li>Select a service on MUX3.</li> <li>Set the IRD to stand-by mode.</li> <li>Verify that the IRD records all the scheduled events and returns back to the originating power state after each scheduled event.</li> <li>Resume the IRD from standby.</li> <li>Verify that all the scheduled events are recorded and they can be played back correctly.</li> </ol> <p><b>Expected results:</b> The IRD performs scheduled recordings correctly in all possible situations. The IRD sets itself back to the originating power state after recording.</p>						
<b>Test result(s)</b>	<p>Measurement record</p> <table border="1" data-bbox="391 1899 1337 2020"> <thead> <tr> <th data-bbox="391 1899 865 1933">Test point</th> <th data-bbox="865 1899 1337 1933">Result OK/NOK</th> </tr> </thead> <tbody> <tr> <td data-bbox="391 1933 865 2000">IRD records individual events with a long gap in between</td> <td data-bbox="865 1933 1337 2000"></td> </tr> <tr> <td data-bbox="391 2000 865 2020">IRD records individual events with a</td> <td data-bbox="865 2000 1337 2020"></td> </tr> </tbody> </table>	Test point	Result OK/NOK	IRD records individual events with a long gap in between		IRD records individual events with a	
Test point	Result OK/NOK						
IRD records individual events with a long gap in between							
IRD records individual events with a							



	short gap in between	
<b>Conformity</b>	<input type="checkbox"/> OK <b>Fault</b> <input type="checkbox"/> Major <input type="checkbox"/> Minor, define fail reason in comments	
<b>Comments</b>	If possible describe if fault can be fixed with software update: <input type="checkbox"/> YES <input type="checkbox"/> NO Describe more specific faults and/or other information	
<b>Date</b>		<b>Sign</b>

	<b>Task 15:12 ESG/EPG recording programming – individual event with CRID</b>	
<b>Section</b>	NorDig Unified 14.3.2	
<b>Requirement</b>	The NorDig PVR shall make it possible for the user to select individual events and series to be recorded from the ESG or EPG display (based on information from EIT data).	
<b>IRD Profile(s)</b>	Basic, PVR, IRD, FE	
<b>Test procedure</b>	<p><b>Purpose of test:</b> To verify that IRD enables ESG/EPG reording programming for individual event.</p> <p><b>Equipment:</b> IRD Under test Stream</p> <p><b>Test procedure:</b></p> <ol style="list-style-type: none"> <li>1. Open the EPG and schedule a recording by selecting an event with CRID in the EPG.</li> <li>2. Verify that the IRD records the event correctly.</li> <li>3. Playback recording initiated by EPG.</li> </ol> <p><b>Expected results:</b> The IRD enables recording from EPG/ESG.</p>	
<b>Test result(s)</b>		
<b>Conformity</b>	<input type="checkbox"/> OK <b>Fault</b> <input type="checkbox"/> Major <input type="checkbox"/> Minor, define fail reason in comments	
<b>Comments</b>	If possible describe if fault can be fixed with software update: <input type="checkbox"/> YES <input type="checkbox"/> NO Describe more specific faults and/or other information	
<b>Date</b>		<b>Sign</b>

	<b>Task 15:13 ESG/EPG recording programming – individual event with CRID – same event recording</b>	
<b>Section</b>	NorDig Unified 14.3.2	
<b>Requirement</b>	If the user selects an event for recording from the ESG/EPG which has the same programme CRID value as an earlier recording within the NorDig PVR list of recordings, the NorDig PVR shall inform the user at the time of booking that this new selected event might already have been recorded and offer the option for the user to record anyway or not (1). The NorDig PVR should display information about this earlier recording (like the event name, date of recording and description).	
<b>IRD Profile(s)</b>	Basic, PVR, IRD, FE	

<b>Test procedure</b>	<p><b>Purpose of test:</b> To verify that IRD informs user if ESG/EPG reording programming for individual event is already set for recording.</p> <p><b>Equipment:</b> IRD Under test Stream with EIT including CRID. Two events shall have the same CRID value.</p> <p><b>Test procedure:</b></p> <ol style="list-style-type: none"> <li>1. Open the EPG and schedule a recording by selecting an event with CRID in the EPG.</li> <li>2. Try schedule another later recording from the ESG/EPG by selecting an event with the same CRID in the EPG that has been already selected for recording.</li> <li>3. Verify that the IRD informs the user that the event is already set for recording.</li> </ol> <p><b>Expected results:</b> The IRD inform user if the same program with same CRID is already selected for recording from the EPG/ESG.</p>
<b>Test result(s)</b>	
<b>Conformity</b>	<input type="checkbox"/> OK <input type="checkbox"/> Fault <input type="checkbox"/> Major <input type="checkbox"/> Minor, define fail reason in comments
<b>Comments</b>	If possible describe if fault can be fixed with software update: <input type="checkbox"/> YES <input type="checkbox"/> NO Describe more specific faults and/or other information
<b>Date</b>	<b>Sign</b>

	<b>Task 15:14 ESG/EPG recording programming – series</b>
<b>Section</b>	NorDig Unified 14.3.3
<b>Requirement</b>	<p>All events that have the same series CRID belongs to the same Series. An individual event inside a Series is referenced here as an Episode. (For definition of CRID see section 12.4.6.2).</p> <p>The NorDig PVR shall be able to record a complete Series via the CRID. The NorDig PVR shall store and track series CRIDs that are programmed for recording for up to 91 days between occurrences in EIT schedule. To allow broadcasters to reuse a series CRID for a different editorial concept, the NorDig PVR shall discard any series CRIDs not seen in EIT for 91 days.</p> <p>The display of programmes selected for recording shall include an indication if the programme is included as a consequence of being one of a series.</p> <p>The IRD should be aware that the default authority may be changed over time (for example a service might have default authority added in SDT), the NorDig PVR should automatically update its stored default authorities (not only during installation).</p> <p>The NorDig PVR shall support recording of all episodes of a specific series via series CRID'ws in the broadcast. It shall be possible from ESG/EPG to program the NorDig PVR to record a series of events.</p> <p>The NorDig PVR shall indicate in the ESG/EPG that an event is part of a series (1). The NorDig PVR shall, if the user selects to record the event that belongs to a series, request the user what to record:</p> <ol style="list-style-type: none"> <li>1.Only the single event selected.</li> <li>2.Several or All events (episodes) of the series</li> </ol>

<b>IRD Profile(s)</b>	Basic, PVR, IRD, FE	
<b>Test procedure</b>	<p><b>Purpose of test:</b> To verify that IRD enables ESG/EPG reording programming for series of events.</p> <p><b>Equipment:</b> IRD Under test Stream with EIT information including CRID.</p> <p><b>Test procedure:</b></p> <ol style="list-style-type: none"> <li>1. Open the EPG and schedule a recording by selecting a series CRID in the EPG.</li> <li>2. Verify that EPG contains information that event is part of the Series</li> <li>3. Initiate recording</li> <li>4. Verify that IRD is asking if one or all Episodes shall be recorded</li> <li>5. Select all Episodes</li> <li>6. Verify that all Episodes of the Series is recorded</li> <li>7. Playback all recordings initiated by EPG and verify that recordings are playbaced correctly</li> </ol> <ol style="list-style-type: none"> <li>8. Open the EPG and schedule a recording by selecting a series CRID in the EPG.</li> <li>9. Verify that EPG contains information that event is part of the Series</li> <li>10. Initiate recording</li> <li>11. Verify that IRD is asking if one or all Episodes shall be recorded</li> <li>12. Select all one Episode</li> <li>13. Verify that only one Episode of the Series is recorded</li> <li>14. Playback recording initiated by EPG and verify that recording is playbaced correctly</li> </ol> <p><b>Expected results:</b> The IRD enables series recording from EPG/ESG.</p>	
<b>Test result(s)</b>		
<b>Conformity</b>	<input type="checkbox"/> OK <b>Fault</b> <input type="checkbox"/> Major <input type="checkbox"/> Minor, define fail reason in comments	
<b>Comments</b>	If possible describe if fault can be fixed with software update: <input type="checkbox"/> YES <input type="checkbox"/> NO Describe more specific faults and/or other information	
<b>Date</b>		<b>Sign</b>

	<b>Task 15:15 Split recordings</b>	
<b>Section</b>	NorDig Unified 14.3.4	
<b>Requirement</b>	<p>A programme may consist of multiple EIT events within the same service or over several services. For example, a film might be divided into two parts/blocks interrupted by a news programme in the middle (see Figure 14.1 A) or a longer sport event might be split into several parts/blocks over several services, (see Figure 14.1 B).</p> <p>Signalling carried in the SI allows the PVR to identify and record all the events containing the parts of a single programme. A “split programme” is a single piece of content which comprises of two or more EIT events having the same CRID and IMI value with the gap from the scheduled end time (start_time plus duration) to the scheduled start time of any two of those events is less than 3 hours (see section 12.4.6).</p> <p>The NorDig PVR shall consider a split programme to be segments of a single item of content (1). When selecting a split programme for recording, the NorDig PVR shall select and record all constituent events so that the complete programme content is recorded.</p>	



	<p>There are cases where a NorDig PVR may during the time of programming a recording only see a single event with the booked CRID and IMI combination (for example initially only the first part/block of the split programme has so far been included in the EIT).</p> <p>The NorDig PVR shall continue to monitor the EIT for additional events with the same CRID and IMI combination and include them to the selected recording (1). In case of overlap between the split events and if the NorDig PVR has limitation in recording capacity when back-to-back recording, then the NorDig PVR shall first finalise recording of the first part/event of the split programme (according to the events start time and duration) before starting recording the next part of the split programme, This is the same behaviour as back-to-back recordings.</p>
<b>IRD Profile(s)</b>	Basic, PVR, IRD, FE
<b>Test procedure</b>	<p><b>Purpose of test:</b> To verify that IRD handles split recordings.</p> <p><b>Equipment:</b></p> <ul style="list-style-type: none"> <li>• IRD Under test</li> <li>• Streams with split events of same content:             <ul style="list-style-type: none"> <li>○ Stream 1: Event splitted on the same channel with max. 3 hour gap between splitted events</li> <li>○ Stream 2: Event splitted between two channels in different multiplexes without gaps between splits</li> <li>○ Stream 3: Event splitted between two channels in different multiplexes with gaps between splits (max. 3 hour)</li> <li>○ Stream 4: Event splitted between two channels in different multiplexes with overlaps between splits</li> </ul> </li> </ul> <p><b>Test procedure:</b></p> <ol style="list-style-type: none"> <li>1. Initiate recording of event part of a content split into several events from EPG.</li> <li>2. The IRD presents information that there are several that are part of the same content and offer to record the whole content.</li> <li>3. Repeat with all test streams</li> </ol> <p><b>Expected result:</b> The IRD is able to initiate recording of several events that are part of the same content and it is indicated in the EPG. The IRD presents this in a user friendly way.</p>
<b>Test result(s)</b>	
<b>Conformity</b>	<input type="checkbox"/> OK <b>Fault</b> <input type="checkbox"/> Major <input type="checkbox"/> Minor, define fail reason in comments
<b>Comments</b>	If possible describe if fault can be fixed with software update: <input type="checkbox"/> YES <input type="checkbox"/> NO Describe more specific faults and/or other information
<b>Date</b>	<b>Sign</b>

	<b>Task 15:16 Split recordings- dynamic update of EIT</b>
<b>Section</b>	NorDig Unified 14.3.4
<b>Requirement</b>	During the lifecycle of EIT schedule broadcasters may change programmes from split to single or vice versa.
<b>IRD Profile(s)</b>	Basic, PVR, IRD, FE

<b>Test procedure</b>	<p><b>Purpose of test:</b> To verify that IRD handles split recordings.</p> <p><b>Equipment:</b></p> <ul style="list-style-type: none"> <li>• IRD Under test</li> <li>• Streams with events of same content: <ul style="list-style-type: none"> <li>○ Stream 1: Event splitted dynamically(*) on the same channel with max. 3 hour gap between splitted events</li> <li>○ Stream 2: Event dynamically(*) splitted between two channels in different multiplexes with out gaps between splits</li> <li>○ Stream 3: Event dynamically(*) splitted between two channels in different multiplexes with gaps between splits (max. 3 hour)</li> <li>○ Stream 4: Event splitted dynamically(*) between two channels in different multiplexes with overlaps between splits</li> <li>○ Stream 5: A splitted event dynamically(*) changed to single event</li> </ul> </li> </ul> <p>* Dynamically means update of the event information to correspond the change of single program to a splitted program or a splitted program to a single program</p> <p><b>Test procedure:</b></p> <ol style="list-style-type: none"> <li>1. Initiate recording of a event that is dynamically changed to splitted event or one event from EPG.</li> <li>2. Verify that the IRD records the whole event.</li> <li>3. Repeat with all test streams</li> </ol> <p><b>Expected result:</b> The IRD is able to record dynamically changed splitted events.</p>	
<b>Test result(s)</b>		
<b>Conformity</b>	<input type="checkbox"/> <b>OK</b> <input type="checkbox"/> <b>Fault</b> <input type="checkbox"/> Major <input type="checkbox"/> Minor, define fail reason in comments	
<b>Comments</b>	If possible describe if fault can be fixed with software update: <input type="checkbox"/> <b>YES</b> <input type="checkbox"/> <b>NO</b> Describe more specific faults and/or other information	
<b>Date</b>	<b>Sign</b>	

	<b>Task 15:17 Recommended events</b>	
<b>Section</b>	NorDig Unified 14.3.5	
<b>Requirement</b>	<p>When the event selected has one or more recommendation(s) associated with it (signalled from original event with crid_type 0x03), the NorDig PVR should offer the option to record the recommendations (programme or series) as well as the selected programme or series.</p> <p>Once selected, the appropriate recommended event(s) shall also be marked as selected to be recorded on the EPG display.</p> <p>The recommended event(s) may also have recommendation(s) of its own. When user chooses to select to include the recommendation(s) into the recording, the NorDig PVR shall not include more than the original event's recommendation(s) (i.e. the NorDig PVR shall not follow more than the original event's initial recommendation and a recommendation should not be used to create a linked list of events to be recorded).</p>	
<b>IRD Profile(s)</b>	Basic, PVR, IRD, FE	

<b>Test procedure</b>	<p><b>Purpose of test:</b> To verify that IRD supports recommended events</p> <p><b>Equipment:</b> IRD Under test Stream with EIT information including CRID for recommendations</p> <p><b>Test procedure:</b></p> <ol style="list-style-type: none"> <li>1. Open EPG and schedule a event</li> <li>2. Verify that IRD recommended only events that are related to the schedule event</li> <li>3. Verify that it is possible to schedule recordings for recommended event</li> </ol> <p><b>Expected results:</b> The IRD supports recommended events</p>
<b>Test result(s)</b>	
<b>Conformity</b>	<input type="checkbox"/> <b>OK</b> <input type="checkbox"/> <b>Fault</b> <input type="checkbox"/> Major <input type="checkbox"/> Minor, define fail reason in comments
<b>Comments</b>	If possible describe if fault can be fixed with software update: <input type="checkbox"/> <b>YES</b> <input type="checkbox"/> <b>NO</b> Describe more specific faults and/or other information
<b>Date</b>	<b>Sign</b>

	<b>Task 15:18 Alternative Recording</b>
<b>Section</b>	NorDig Unified 14.3.6
<b>Requirement</b>	<p>When scheduled recordings overlap, the NorDig PVR shall use the alternate instance information (1), when provided, to record one or more of the programmes at their alternate times thereby minimising the conflict, subject to any device limitations (e.g. available space).</p> <p>Where a programme is repeated in its entirety a broadcaster may assign the same programme CRID to both EIT events. The NorDig PVR should detect an alternative instance of a programme (as when two events has same programme CRID) (1). This can be used to assist in resolution of booking clashes.</p> <p>Where alternate instances belong to the same series this allows the NorDig PVR to only record a single showing of each episode, usually the first.</p>
<b>IRD Profile(s)</b>	Basic, PVR, IRD, FE
<b>Test procedure</b>	<p><b>Purpose of test:</b> To verify that IRD handles alternative instance recording.</p> <p><b>Equipment:</b></p> <ul style="list-style-type: none"> <li>• IRD Under test</li> <li>• Stream 1: Recorded stream with split information about alternative instance of event on same channel.</li> <li>• Stream 2: Recorded stream with split information about alternative instance of event on same channel.</li> </ul> <p><b>Test procedure:</b></p> <ol style="list-style-type: none"> <li>1. Playout stream 1.</li> <li>2. Schedule an event conflicting with the event with alternative instance.</li> <li>3. The IRD shall notify that there is a collision but that there is an alternative instance that can be recorded on the same service instead.</li> <li>4. Playout stream 2.</li> <li>5. Schedule an event conflicting with the event with alternative instance.</li> <li>6. The IRD shall notify that there is a collision but that there is an alternative instance that can be recorded on another service instead.</li> </ol>

	<b>Expected result:</b> The IRD is able to use alternative information to record a programme at an alternative time in the case of conflict, including also on other TV services.
<b>Test result(s)</b>	
<b>Conformity</b>	<input type="checkbox"/> OK <input type="checkbox"/> Fault <input type="checkbox"/> Major <input type="checkbox"/> Minor, define fail reason in comments
<b>Comments</b>	If possible describe if fault can be fixed with software update: <input type="checkbox"/> YES <input type="checkbox"/> NO Describe more specific faults and/or other information
<b>Date</b>	<b>Sign</b>

	<b>Task 15:19 Accurate Recording – EIT information present</b>
<b>Section</b>	NorDig Unified 14.3.7
<b>Requirement</b>	<p>The NorDig PVR shall determine the timing of the recording through monitoring of the EIT schedule and EIT present/following information.</p> <p>The NorDig PVR shall record at least for the duration where the event ID in the EIT present table matches the event ID of the event selected from the EIT schedule to a precision of 10 Seconds, unless there is a conflict with another recording event.</p> <p>Where the Event ID is signalled in EIT present table early (in advance of the schedule start_time) the NorDig PVR shall start recording. As a minimum the NorDig PVR shall handle early starts of at least 10 minutes, provided there are no other recordings in progress.</p> <p>The NorDig PVR shall monitor the EIT schedule and EIT present/following for updates to the start time and duration such that any event will be captured should the schedule be updated no later than 2 minutes prior to the current scheduled time of broadcast.</p> <p>Where the Event ID does not appear within EITp/f (in neither the present nor following tables) within the expected schedule time and duration the NorDig PVR should record according to the scheduled start time and duration. If the event id appears in the EIT following table at the scheduled start time, it means that the event is delayed and the NorDig PVR should wait with the start of the recording until the event ID appears in the EIT present table.</p> <p>The duration of the recording shall be changed even if the EITp/f is updated after the start time has elapsed, until the event is no longer present in the EIT present tab.</p>
<b>IRD Profile(s)</b>	Basic, PVR, IRD, FE
<b>Test procedure</b>	<p><b>Purpose of test:</b> To verify that IRD handles accurate recording based on the EIT information according to the PVR_rec minimum scenario.</p> <p><b>Equipment:</b> IRD Under test Stream with EIT information that is updated accurately (EIT present table), having consequent EIT schedule and EIT p/f scenarios as follows:</p> <ul style="list-style-type: none"> <li>• EIT1: Event start_time<sub>1</sub>, duration = duration<sub>1</sub>.</li> <li>• EIT2: Event start_time<sub>2</sub> = start_time<sub>1</sub>-10min and duration<sub>2</sub> ≠ duration<sub>1</sub>.</li> <li>• EIT3: Event start_time<sub>3</sub>&gt;start_time<sub>2</sub>, duration<sub>3</sub> = duration<sub>2</sub>.</li> <li>• EIT4: Event start_time<sub>4</sub>=start_time<sub>3</sub>, duration<sub>4</sub>=duration<sub>3</sub>.</li> <li>• EIT5: Event start_time<sub>5</sub>=start_time<sub>4</sub>, duration<sub>5</sub>&gt;duration<sub>4</sub>.</li> </ul> <p>Each scenario consists of multiple EIT sections:</p> <ul style="list-style-type: none"> <li>• Event shall be included in the EIT_schedule of EIT1.</li> <li>• Event shall be included in the EIT_following of EIT2 and EIT3.</li> <li>• Event shall be included in the EIT_present of EIT4 and EIT5.</li> <li>• Event start_time and duration shall be constant in EIT_schedule during the test.</li> </ul> <p>Event event_id shall be constant during the test.</p>



Event name or short\_event\_descriptor may be updated to indicate the originating EIT scenario number.

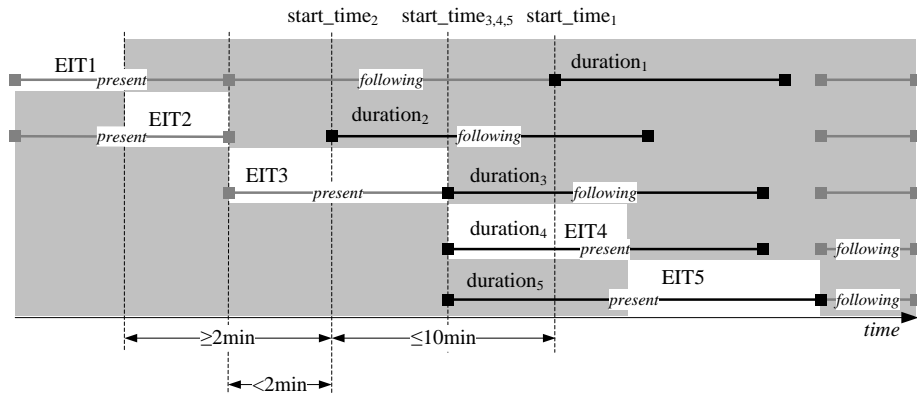

**Test procedure:**

1. Broadcast EIT schedule and EIT p/f scenario EIT1.
2. Schedule Event for recording from EPG/ESG.
3. Set IRD into the stand-by mode.
4. Update EIT scenario to EIT2, where Event start\_time and duration are updated.
5. Shortly before start\_time<sub>2</sub>, update EIT scenario to EIT3, where start\_time is delayed.
6. Update EIT scenario to EIT4 at start\_time<sub>3</sub> so that Event is the present event.
7. While Event is present, update EIT scenario to EIT5, where duration is updated.
8. Fill in the measurement record.

**Expected results:**

The IRD performs accurate recording based on the EIT present information. Recording should start at start\_time<sub>4</sub> or alternatively recording shall start at start\_time<sub>2</sub> ±10 s. Recording shall stop at start\_time<sub>5</sub>+duration<sub>5</sub>±10 s.

**Test result(s)**

Measurement record	
Test point	Result OK/NOK
IRD prioritizes EIT_present/following over EIT_schedule	
IRD handles correctly an early start of a scheduled event	
IRD handles correctly a delayed start of a scheduled event	
IRD handles EIT present duration update during recording	
Recording begins according to EIT present ±10 s.	
Recording is stopped according to EIT present ± 10 s.	
Recording is not indicated as incomplete.	
Recording is correctly viewable	

**Conformity**  OK  Fault  Major  Minor, define fail reason in comments

**Comments** If possible describe if fault can be fixed with software update:  YES  NO  
Describe more specific faults and/or other information

**Date** \_\_\_\_\_ **Sign** \_\_\_\_\_

<b>Task 15:20 Accurate Recording – EIT information missing</b>	
<b>Section</b>	NorDig Unified 14.3.7

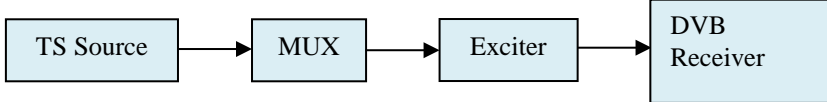
<b>Requirement</b>	<p>Where the Event ID does not appear within EITp/f (in neither the present nor following tables) within the expected schedule time and duration the NorDig PVR should record according to the scheduled start time and duration. If the event id appears in the EIT following table at the scheduled start time, it means that the event is delayed and the NorDig PVR should wait with the start of the recording until the event ID appears in the EIT present table.</p> <p>The duration of the recording shall be changed even if the EITp/f is updated after the start time has elapsed, until the event is no longer present in the EIT present table.</p> <p>If the NorDig PVR starts to record at the expected scheduled start time even if the event does not appear within EIT p/f, the recording shall be considered as incomplete.</p> <p>Where there is a loss of signal or EIT present table is no longer being received, the NorDig PVR will continue to record at least until the end time of the event (defined by start_time plus duration) in the last received EITp/f. If the signal is restored the NorDig PVR will continue to record according to its normal operation.</p>												
<b>IRD Profile(s)</b>	Basic, PVR, IRD, FE												
<b>Test procedure</b>	<p><b>Purpose of test:</b> To verify that IRD handles accurate recording based on the EIT information</p> <p><b>Equipment:</b></p> <div style="text-align: center;">  <pre> graph LR     A[TS Source] --&gt; B[MUX]     B --&gt; C[Exciter]     C --&gt; D[DVB Receiver]             </pre> </div> <p>Stream with EIT information that is updated (EIT present table)</p> <p><b>Test procedure:</b></p> <ol style="list-style-type: none"> <li>Schedule an event for recording from EPG/ESG.</li> <li>Set IRD into the stand-by mode</li> <li>Remove EIT information</li> <li>Verify that IRD checks the EIT information and updates recording before scheduled recording.</li> <li>Verify that recording is completed as indicated at the initial time of the recording and missing EIT present information do not change the initial recording.</li> </ol> <p><b>Expected results:</b> The IRD performs accurate recording without EIT information</p>												
<b>Test result(s)</b>	<p>Measurement record</p> <table border="1" style="width: 100%;"> <thead> <tr> <th style="width: 70%;">Test point</th> <th style="width: 30%;">Result OK/NOK</th> </tr> </thead> <tbody> <tr> <td>IRD checks the EIT information at least 10 min before scheduled recording takes place</td> <td></td> </tr> <tr> <td>Recording begins according to EIT schedule</td> <td></td> </tr> <tr> <td>Recording is stopped according to EIT schedule</td> <td></td> </tr> <tr> <td>IRD indicates that the recording is incomplete</td> <td></td> </tr> <tr> <td>The recording is correctly viewable</td> <td></td> </tr> </tbody> </table>	Test point	Result OK/NOK	IRD checks the EIT information at least 10 min before scheduled recording takes place		Recording begins according to EIT schedule		Recording is stopped according to EIT schedule		IRD indicates that the recording is incomplete		The recording is correctly viewable	
Test point	Result OK/NOK												
IRD checks the EIT information at least 10 min before scheduled recording takes place													
Recording begins according to EIT schedule													
Recording is stopped according to EIT schedule													
IRD indicates that the recording is incomplete													
The recording is correctly viewable													
<b>Conformity</b>	<input type="checkbox"/> OK <input type="checkbox"/> Fault <input type="checkbox"/> Major <input type="checkbox"/> Minor, define fail reason in comments												
<b>Comments</b>	<p>If possible describe if fault can be fixed with software update: <input type="checkbox"/> YES <input type="checkbox"/> NO</p> <p>Describe more specific faults and/or other information</p>												
<b>Date</b>	<b>Sign</b>												
<b>Task 15:21 Accurate Recording – Loss of signal</b>													
<b>Section</b>	NorDig Unified 14.3.7												

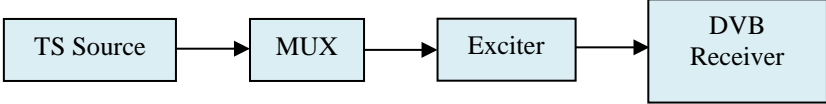
<b>Requirement</b>	Where there is a loss of signal or EIT present table is no longer being received, the NorDig PVR will continue to record at least until the end time of the event (defined by start_time plus duration) in the last received EITp/f. If the signal is restored the NorDig PVR will continue to record according to its normal operation.										
<b>IRD Profile(s)</b>	Basic, PVR, IRD, FE										
<b>Test procedure</b>	<p><b>Purpose of test:</b> To verify that IRD handles accurate recording in spite of reception problems.</p> <p><b>Equipment:</b></p> <div style="text-align: center;">  <pre> graph LR     TS[TS Source] --&gt; MUX[MUX]     MUX --&gt; Exciter[Exciter]     Exciter --&gt; DVB[DVB Receiver]             </pre> </div> <p>Test stream shall contain EIT_actual schedule and present/following tables.</p> <p><b>Test procedure:</b></p> <ol style="list-style-type: none"> <li>Schedule the event 'Test Event' for recording from EPG</li> <li>Set IRD into the stand-by mode</li> <li>Disconnect IRD from the Exciter while the recording is ongoing.</li> <li>Re-connect the IRD to the Exciter before the end time of the event.</li> <li>Wake up the IRD from stand-by after the recording is completed.</li> <li>Play back the recording.</li> <li>Fill in the measurement record.</li> </ol> <p><b>Expected results:</b> IRD is able to handle reception errors gracefully. IRD indicates the incomplete recordings.</p>										
<b>Test result(s)</b>	<p>Measurement record</p> <table border="1" style="width: 100%;"> <thead> <tr> <th>Test point</th> <th>Result OK/NOK</th> </tr> </thead> <tbody> <tr> <td>IRD continues recording after signal is re-connected</td> <td></td> </tr> <tr> <td>Recording is stopped at the end time of the event</td> <td></td> </tr> <tr> <td>IRD indicates that the recording is incomplete</td> <td></td> </tr> <tr> <td>The incomplete recording is viewable to the largest possible extent</td> <td></td> </tr> </tbody> </table>	Test point	Result OK/NOK	IRD continues recording after signal is re-connected		Recording is stopped at the end time of the event		IRD indicates that the recording is incomplete		The incomplete recording is viewable to the largest possible extent	
Test point	Result OK/NOK										
IRD continues recording after signal is re-connected											
Recording is stopped at the end time of the event											
IRD indicates that the recording is incomplete											
The incomplete recording is viewable to the largest possible extent											
<b>Conformity</b>	<input type="checkbox"/> OK <input type="checkbox"/> Fault <input type="checkbox"/> Major <input type="checkbox"/> Minor, define fail reason in comments										
<b>Comments</b>	If possible describe if fault can be fixed with software update: <input type="checkbox"/> YES <input type="checkbox"/> NO Describe more specific faults and/or other information										
<b>Date</b>	<b>Sign</b>										

	<b>Task 15:22 Accurate Recording – EIT update in stand-by</b>
<b>Section</b>	NorDig Unified 14.3.7
<b>Requirement</b>	In standby mode (where the NorDig PVR IRD is not decoding any transport stream) the NorDig PVR shall have the capability to power on automatically twice per day to update the EIT and scheduled recordings. There may be an option to amend the time of power on or to switch off the facility as a user option, but factory default for this shall be that it is on.
<b>IRD Profile(s)</b>	Basic, PVR, IRD, FE
<b>Test procedure</b>	<p><b>Purpose of test:</b> To verify that IRD check the EIT schedule information at least twice per day in stand-by mode</p> <p><b>Equipment:</b> IRD Under test Stream with EIT information that is updated</p>



<b>Test procedure:</b>	<ol style="list-style-type: none"> <li>1. Schedule a recording from ESG/EPG for 24 hours from current time.</li> <li>2. Set IRD to stand-by mode.</li> <li>3. While IRD is in stand-by mode, update the EIT Schedule information so that the start times and durations of the scheduled recording are changed.</li> <li>4. After 12 hours, update the EIT Schedule information again.</li> <li>5. Verify that IRD updates the EIT information at least twice a day and performs the recordings correctly according to the changed EIT information.</li> <li>6. Verify that IRD has performed the recordings correctly according to the updated EIT Schedule.</li> </ol>
<b>Expected results:</b>	The IRD IRD checks the EIT information and updates the recording accordingly at least twice a day.
<b>Test result(s)</b>	
<b>Conformity</b>	<input type="checkbox"/> <b>OK</b> <input type="checkbox"/> <b>Fault</b> <input type="checkbox"/> Major <input type="checkbox"/> Minor, define fail reason in comments
<b>Comments</b>	If possible describe if fault can be fixed with software update: <input type="checkbox"/> <b>YES</b> <input type="checkbox"/> <b>NO</b> Describe more specific faults and/or other information
<b>Date</b>	<i>Sign</i>

<b>Test Case</b>	<b>Task 15:23 Simultaneous recording – OTR and viewing</b>											
<b>Section</b>	NorDig Unified 14.3.8 and 14.3.15											
<b>Requirement</b>	The NorDig PVRs shall be able to record one service while viewing another, independently even if the services are on different transport streams.											
<b>IRD Profile(s)</b>	Basic, PVR, IRD, FE											
<b>Test procedure</b>	<p><b>Purpose of test:</b> To verify that the IRD handles the simultaneous recording.</p> <p><b>Test Equipment:</b> Live network or a test network of at least 2 MUX with both SD and HD services (TBD).</p> <p><b>Test procedure:</b></p> <ol style="list-style-type: none"> <li>1. Initiate OTR.</li> <li>2. Zap to a service on another multiplex.</li> <li>3. Watch and change the service for a few times.</li> <li>4. Stop OTR.</li> <li>5. Play back the recording</li> </ol> <p><b>Expected results:</b> The NorDig PVRs shall be able to record one service while viewing another, independently even if the services are on different transport streams.</p>											
<b>Test result(s)</b>	<table border="1" style="width: 100%;"> <thead> <tr> <th style="width: 70%;">Test point</th> <th style="width: 30%;">Result OK/NOK</th> </tr> </thead> <tbody> <tr> <td>IRD is able to tune to another service while recording.</td> <td></td> </tr> <tr> <td>OTR recording does not disturb viewing.</td> <td></td> </tr> <tr> <td>Viewing does not disturb the recording.</td> <td></td> </tr> <tr> <td>Channel change does not disturb the recording.</td> <td></td> </tr> </tbody> </table>		Test point	Result OK/NOK	IRD is able to tune to another service while recording.		OTR recording does not disturb viewing.		Viewing does not disturb the recording.		Channel change does not disturb the recording.	
Test point	Result OK/NOK											
IRD is able to tune to another service while recording.												
OTR recording does not disturb viewing.												
Viewing does not disturb the recording.												
Channel change does not disturb the recording.												
<b>Conformity</b>	<input type="checkbox"/> <b>OK</b> <input type="checkbox"/> <b>Fault</b> <input type="checkbox"/> Major <input type="checkbox"/> Minor, define fail reason in comments											
<b>Comments</b>	If possible describe if fault can be fixed with software update: <input type="checkbox"/> <b>YES</b> <input type="checkbox"/> <b>NO</b> Describe more specific faults and/or other information											
<b>Date</b>	<i>Sign</i>											

<b>Test Case</b>	<b>Task 15:24 Simultaneous recording – Scheduled recording and viewing</b>											
<b>Section</b>	NorDig Unified 14.3.8 and 14.3.16											
<b>Requirement</b>	The NorDig PVRs shall be able to record one service while viewing another, independently even if the services are on different transport streams.											
<b>IRD Profile(s)</b>	Basic, PVR, IRD, FE											
<b>Test procedure</b>	<p><b>Purpose of test:</b> To verify that the IRD handles the simultaneous recording.</p> <p><b>Test Equipment:</b> Live network or a test network of at least 2 MUX with both SD and HD services (TBD).</p> <p><b>Test procedure:</b></p> <ol style="list-style-type: none"> <li>1. Schedule a recording from EPG/ESG.</li> <li>2. Zap to a service on another multiplex.</li> <li>3. Watch and change the service for a few times until the scheduled recording is completed.</li> <li>4. Play back the recording.</li> </ol> <p><b>Expected results:</b> The NorDig PVRs shall be able to record one service while viewing another, independently even if the services are on different transport streams.</p>											
<b>Test result(s)</b>	<p>Measurement record</p> <table border="1"> <thead> <tr> <th>Test point</th> <th>Result OK/NOK</th> </tr> </thead> <tbody> <tr> <td>IRD is able to tune to another service while scheduled recording is ongoing.</td> <td></td> </tr> <tr> <td>Scheduled recording does not disturb viewing.</td> <td></td> </tr> <tr> <td>Viewing does not disturb the recording.</td> <td></td> </tr> <tr> <td>Channel change does not disturb the recording.</td> <td></td> </tr> </tbody> </table>		Test point	Result OK/NOK	IRD is able to tune to another service while scheduled recording is ongoing.		Scheduled recording does not disturb viewing.		Viewing does not disturb the recording.		Channel change does not disturb the recording.	
Test point	Result OK/NOK											
IRD is able to tune to another service while scheduled recording is ongoing.												
Scheduled recording does not disturb viewing.												
Viewing does not disturb the recording.												
Channel change does not disturb the recording.												
<b>Conformity</b>	<input type="checkbox"/> <b>OK Fault</b> <input type="checkbox"/> Major <input type="checkbox"/> Minor, define fail reason in comments											
<b>Comments</b>	If possible describe if fault can be fixed with software update: <input type="checkbox"/> <b>YES</b> <input type="checkbox"/> <b>NO</b> Describe more specific faults and/or other information											
<b>Date</b>		<i>Sign</i>										

<b>Test Case</b>	<b>Task 15:25 Simultaneous recording – OTR and time-shift</b>	
<b>Section</b>	NorDig Unified 14.3.8, 14.3.12, 14.3.15 and 14.4.2	
<b>Requirement</b>	The NorDig PVR should be able to record a background service (that is not viewed) at the same time as timeshift record the viewing service, independently if the services are on different transport streams.	
<b>IRD Profile(s)</b>	Basic, PVR, IRD, FE	
<b>Test procedure</b>	<p><b>Purpose of test:</b> To verify that the IRD handles the simultaneous recording and timeshift.</p> <p><b>Test Equipment:</b> Live network or a test network of at least 2 MUX with both SD and HD services (TBD).</p> <p><b>Test procedure:</b></p> <ol style="list-style-type: none"> <li>1. Initiate OTR.</li> <li>2. Zap to a service on another multiplex.</li> <li>3. Initiate timeshift and pause viewing for few minutes.</li> <li>4. View, Fast forward, Rewind and Pause the timeshifted video in a random pattern.</li> </ol>	

	<ol style="list-style-type: none"> <li>5. Fast forward the playback the timeshifted content to real time. Rewind and view.</li> <li>6. Stop the timeshift.</li> <li>7. Stop OTR.</li> <li>8. Play back the recording.</li> </ol> <p><b>Expected results:</b> The NorDig PVR is able to timeshift another service while recording.</p>														
<b>Test result(s)</b>	<table border="1"> <tr> <td colspan="2">Measurement record</td> </tr> <tr> <td><b>Test point</b></td> <td><b>Result OK/NOK</b></td> </tr> <tr> <td>IRD is able to timeshift another service while recording.</td> <td></td> </tr> <tr> <td>OTR recording does not disturb timeshift functionality.</td> <td></td> </tr> <tr> <td>Timeshift pause does not disturb the recording.</td> <td></td> </tr> <tr> <td>Timeshift viewing does not disturb the recording.</td> <td></td> </tr> <tr> <td>Timeshift FF/REW/PAUSE does not disturb the recording.</td> <td></td> </tr> </table>	Measurement record		<b>Test point</b>	<b>Result OK/NOK</b>	IRD is able to timeshift another service while recording.		OTR recording does not disturb timeshift functionality.		Timeshift pause does not disturb the recording.		Timeshift viewing does not disturb the recording.		Timeshift FF/REW/PAUSE does not disturb the recording.	
Measurement record															
<b>Test point</b>	<b>Result OK/NOK</b>														
IRD is able to timeshift another service while recording.															
OTR recording does not disturb timeshift functionality.															
Timeshift pause does not disturb the recording.															
Timeshift viewing does not disturb the recording.															
Timeshift FF/REW/PAUSE does not disturb the recording.															
<b>Conformity</b>	<input type="checkbox"/> <b>OK</b> <input type="checkbox"/> <b>Fault</b> <input type="checkbox"/> Major <input type="checkbox"/> Minor, define fail reason in comments														
<b>Comments</b>	If possible describe if fault can be fixed with software update: <input type="checkbox"/> <b>YES</b> <input type="checkbox"/> <b>NO</b> Describe more specific faults and/or other information														
<b>Date</b>	<table border="1"> <tr> <td></td> <td><i>Sign</i></td> <td></td> </tr> </table>		<i>Sign</i>												
	<i>Sign</i>														







<b>Test Case</b>	<b>Task 15:26 Simultaneous recording – Scheduled recording and time-shift</b>														
<b>Section</b>	NorDig Unified 14.3.8, 14.3.12, 14.3.16 and 14.4.2														
<b>Requirement</b>	The NorDig PVR should be able to record a background service (that is not viewed) at the same time as timeshift record the viewing service, independently if the services are on different transport streams.														
<b>IRD Profile(s)</b>	Basic, PVR, IRD, FE														
<b>Test procedure</b>	<p><b>Purpose of test:</b> To verify that the IRD handles the simultaneous recording and timeshift.</p> <p><b>Test Equipment:</b> Live network or a test network of at least 2 MUX with both SD and HD services (TBD).</p> <p><b>Test procedure:</b></p> <ol style="list-style-type: none"> <li>1. Schedule a recording from EPG/ESG.</li> <li>2. Zap to a service on another multiplex.</li> <li>3. Initiate timeshift and pause viewing for few minutes.</li> <li>4. View, Fast forward, Rewind and Pause the timeshifted video in a random pattern.</li> <li>5. Chase playback the timeshifted content to real time. Rewind and view again.</li> <li>5. Stop the timeshift after the scheduled recording is completed.</li> <li>6. Play back the recording.</li> </ol> <p><b>Expected results:</b> The NorDig PVR is able to timeshift another service while recording.</p>														
<b>Test result(s)</b>	<table border="1"> <tr> <td colspan="2">Measurement record</td> </tr> <tr> <td><b>Test point</b></td> <td><b>Result OK/NOK</b></td> </tr> <tr> <td>IRD is able to timeshift another service while recording.</td> <td></td> </tr> <tr> <td>Scheduled recording does not disturb timeshift functionality.</td> <td></td> </tr> <tr> <td>Timeshift pause does not disturb the recording.</td> <td></td> </tr> <tr> <td>Timeshift viewing does not disturb the recording.</td> <td></td> </tr> <tr> <td>Timeshift replay and trick modes do not disturb the recording.</td> <td></td> </tr> </table>	Measurement record		<b>Test point</b>	<b>Result OK/NOK</b>	IRD is able to timeshift another service while recording.		Scheduled recording does not disturb timeshift functionality.		Timeshift pause does not disturb the recording.		Timeshift viewing does not disturb the recording.		Timeshift replay and trick modes do not disturb the recording.	
Measurement record															
<b>Test point</b>	<b>Result OK/NOK</b>														
IRD is able to timeshift another service while recording.															
Scheduled recording does not disturb timeshift functionality.															
Timeshift pause does not disturb the recording.															
Timeshift viewing does not disturb the recording.															
Timeshift replay and trick modes do not disturb the recording.															
<b>Conformity</b>	<input type="checkbox"/> <b>OK</b> <input type="checkbox"/> <b>Fault</b> <input type="checkbox"/> Major <input type="checkbox"/> Minor, define fail reason in comments														



<b>Comments</b>	If possible describe if fault can be fixed with software update: <input type="checkbox"/> YES <input type="checkbox"/> NO Describe more specific faults and/or other information		
<b>Date</b>		<b>Sign</b>	

<b>Test Case</b>	<b>Task 15:27 Simultaneous recording and playback</b>														
<b>Section</b>	NorDig Unified 14.4.4														
<b>Requirement</b>	The NorDig PVR shall be able to record and playback simultaneously. It shall be possible to record one service from the live transmissions while playback another earlier recording. The user shall be also able to start the playback of a recording for which the recording has not yet completed (“chase playback”).														
<b>IRD Profile(s)</b>	Basic, PVR, IRD, FE														
<b>Test procedure</b>	<p><b>Purpose of test:</b> To verify that the IRD handles the simultaneous recording and playback.</p> <p><b>Test Equipment:</b> Live network or a test network of at least 2 MUX with both SD and HD services (TBD).</p> <p><b>Test procedure:</b></p> <ol style="list-style-type: none"> <li>1. Initiate OTR.</li> <li>2. Zap to a service on another multiplex.</li> <li>3. Play back the recording initiated in test step 1.</li> <li>4. View, Fast forward, Rewind and Pause the timeshifted video in a random pattern.</li> <li>5. Fast forward the playback the timeshifted content to real time. Rewind and view.</li> <li>6. Stop the playback.</li> <li>7. Stop OTR.</li> <li>8. Play back the recording.</li> </ol> <p><b>Expected results:</b> The NorDig PVRs shall be able to record and playback simultaneously. Chase playback is possible.</p>														
<b>Test result(s)</b>	<p>Measurement record</p> <table border="1" style="width: 100%;"> <thead> <tr> <th style="width: 70%;">Test point</th> <th style="width: 30%;">Result OK/NOK</th> </tr> </thead> <tbody> <tr> <td>IRD is able to playback an ongoing recording.</td> <td></td> </tr> <tr> <td>Playback does not disturb the recording functionality.</td> <td></td> </tr> <tr> <td>Playback pause does not disturb the recording.</td> <td></td> </tr> <tr> <td>Playback viewing does not disturb the recording.</td> <td></td> </tr> <tr> <td>Playback FF/REW does not disturb the recording.</td> <td></td> </tr> </tbody> </table>			Test point	Result OK/NOK	IRD is able to playback an ongoing recording.		Playback does not disturb the recording functionality.		Playback pause does not disturb the recording.		Playback viewing does not disturb the recording.		Playback FF/REW does not disturb the recording.	
Test point	Result OK/NOK														
IRD is able to playback an ongoing recording.															
Playback does not disturb the recording functionality.															
Playback pause does not disturb the recording.															
Playback viewing does not disturb the recording.															
Playback FF/REW does not disturb the recording.															
<b>Conformity</b>	<input type="checkbox"/> OK Fault <input type="checkbox"/> Major <input type="checkbox"/> Minor, define fail reason in comments														
<b>Comments</b>	If possible describe if fault can be fixed with software update: <input type="checkbox"/> YES <input type="checkbox"/> NO Describe more specific faults and/or other information														
<b>Date</b>		<b>Sign</b>													

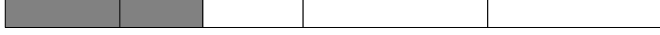
	<b>Task 15:28 Back-to-back recordings – Static EIT information</b>		
<b>Section</b>	NorDig Unified 14.3.11, 14.3.16.2		
<b>Requirement</b>	The NorDig PVR shall be able to record back-to-back events both on same and on		

	<p>different services.</p> <p>Back-to-back events refer to two events that immediately follow each other, i.e. the following event start_time is immediately after the previous events stop time,(start_time plus duration).</p> <p>For overlapping events see NorDig Unified 14.3.16.2. If the first event has same or higher priority as the second event (see 14.3.16.2) and the first event will overrun, if the NorDig PVR has limitation in recording capacity, it shall first finalise recording of the first event (including its overrun part) before starting recording the next event.</p> <p>The overrun shall be treated as the more important part of the events, see figure below. If the NorDig PVR has been set to add additional recording time (“safe margins”) before and after recorded events’ start and stop time, any overlapping “safe margins” between the back-to-back events shall be removed (if the NorDig PVR has limitation in recording capacity for this)</p> <p>If a conflict occurs in a partially or completely overlapping recording after the time of programming the NorDig PVR shall prioritize the recording with the highest priority , as illustrated in figures below. For conflict with events with same priority, the NorDig PVR shall first finalize the first recording (including any late over-run) before starting with next. (See also back-to-back recording).</p>
<p><b>IRD Profile(s)</b></p>	<p>Basic, PVR, IRD, FE</p>
<p><b>Test procedure</b></p>	<p><b>Purpose of test:</b> To verify that IRD handles back-to-back recording</p> <p><b>Equipment:</b> IRD Under test Test network of at least 2 MUX, with services as follows:</p> <ul style="list-style-type: none"> <li>• Services with EIT information that indicate programs are back-to-back</li> <li>• Services with EIT information that indicate programs are overlapping</li> </ul> <p>TS1    Test11                 Test12 </p> <p>TS2    Test21                 Test22 </p> <p style="text-align: right;"><i>time</i> →</p> <p>Example: For all scheduled events, <math>start\_time_N = (start\_time_{N-1} + duration_{N-1})</math></p> <p>TS1    Test11                 Test12 </p> <p>TS2    Test21                 Test22 </p> <p style="text-align: right;"><i>time</i> →</p> <p>Example: For all scheduled events, <math>start\_time_N &lt; (start\_time_{N-1} + duration_{N-1})</math></p> <p><b>Test procedure:</b></p> <ol style="list-style-type: none"> <li>1. Schedule recordings from EPG that are back-to-back</li> <li>2. Verify that the events are recorded correctly</li> <li>3. Verify that playback of the events are correct</li> <li>4. Schedule recordings from EPG that are overlapping</li> <li>5. Verify that the events are recorded correctly (in conflict situation, the earlier recording has the priority)</li> <li>6. Verify that playback of the events are correct</li> </ol>



	<b>Expected results:</b> The IRD handles back-to-back recording correctly.																				
<b>Test result(s)</b>	Measurement record <table border="1"> <thead> <tr> <th>Test point</th> <th>Result OK/NOK</th> </tr> </thead> <tbody> <tr> <td>IRD records back-to-back events correctly from</td> <td></td> </tr> <tr> <td>- the same service</td> <td></td> </tr> <tr> <td>- different services on same multiplex</td> <td></td> </tr> <tr> <td>- different services on different multiplexes</td> <td></td> </tr> <tr> <td>IRD records overlapping events correctly from</td> <td></td> </tr> <tr> <td>- the same service</td> <td></td> </tr> <tr> <td>- different services on same multiplex</td> <td></td> </tr> <tr> <td>- different services on different multiplexes</td> <td></td> </tr> <tr> <td>IRD handles possible recording conflicts correctly</td> <td></td> </tr> </tbody> </table>	Test point	Result OK/NOK	IRD records back-to-back events correctly from		- the same service		- different services on same multiplex		- different services on different multiplexes		IRD records overlapping events correctly from		- the same service		- different services on same multiplex		- different services on different multiplexes		IRD handles possible recording conflicts correctly	
Test point	Result OK/NOK																				
IRD records back-to-back events correctly from																					
- the same service																					
- different services on same multiplex																					
- different services on different multiplexes																					
IRD records overlapping events correctly from																					
- the same service																					
- different services on same multiplex																					
- different services on different multiplexes																					
IRD handles possible recording conflicts correctly																					
<b>Conformity</b>	<input type="checkbox"/> OK <input type="checkbox"/> Fault <input type="checkbox"/> Major <input type="checkbox"/> Minor, define fail reason in comments																				
<b>Comments</b>	If possible describe if fault can be fixed with software update: <input type="checkbox"/> YES <input type="checkbox"/> NO Describe more specific faults and/or other information																				
<b>Date</b>	<b>Sign</b>																				

	<b>Task 15:29 Back-to-back recordings – Changes in EIT information</b>
<b>Section</b>	NorDig Unified 14.3.11, 14.3.16.2
<b>Requirement</b>	<p>The NorDig PVR shall be able to record back-to-back events both on same and on different services.</p> <p>Back-to-back events refer to two events that immediately follow each other, i.e. the following event start_time is immediately after the previous events stop time.(start_time plus duration).</p> <p>For overlapping events see NorDig Unified 14.3.16.2. If the first event has same or higher priority as the second event (see 14.3.16.2) and the first event will overrun, if the NorDig PVR has limitation in recording capacity, it shall first finalise recording of the first event (including its overrun part) before starting recording the next event.</p> <p>The overrun shall be treated as the more important part of the events, see figure below. If the NorDig PVR has been set to add additional recording time (“safe margins”) before and after recorded events’ start and stop time, any overlapping “safe margins” between the back-to-back events shall be removed (if the NorDig PVR has limitation in recording capacity for this)</p> <p>If a conflict occurs in a partially or completely overlapping recording after the time ofprogramming the NorDig PVR shall prioritize the recording with the highest priority , as illustrated in figures below. For conflict with events with same priority, the NorDig PVR shall first finalize the first recording (including any late over-run) before starting with next. (See also back-to-back recording).</p>
<b>IRD Profile(s)</b>	Basic, PVR, IRD, FE
<b>Test procedure</b>	<p><b>Purpose of test:</b> To verify that IRD handles back-to-back recording with dynamic update in EIT</p> <p><b>Equipment:</b> IRD Under test Test network of at least 2 MUX, with services as follows:</p> <ul style="list-style-type: none"> <li>• Services with EIT information updated to indicate programs are back-to-back</li> <li>• Services with EIT information updated to indicate programs are overlapping</li> </ul>

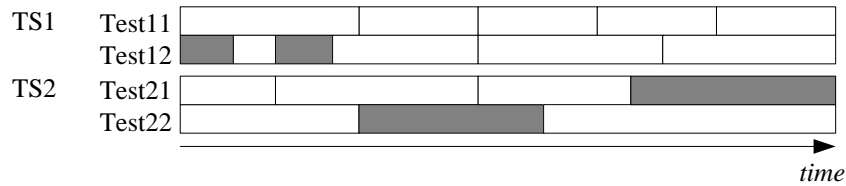

Initial situation example: For all scheduled events,  $start\_time_N > (start\_time_{N-1} + duration_{N-1})$

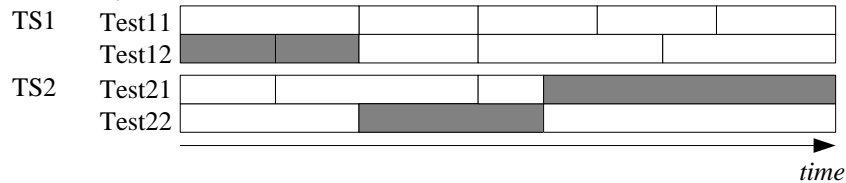

Example: For all scheduled events,  $start\_time_N = (start\_time_{N-1} + duration_{N-1})$

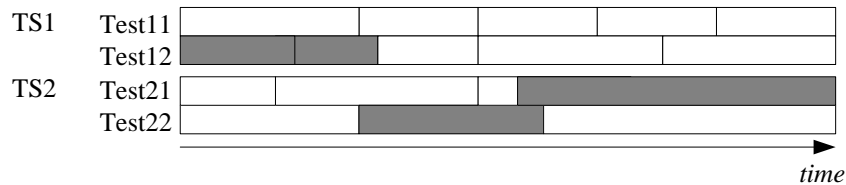

Example: For all scheduled events,  $start\_time_N < (start\_time_{N-1} + duration_{N-1})$

**Test procedure:**

1. Schedule recordings from EPG as per the initial situation.
2. Update the EIT in a way that the events will be back-to-back
3. Verify that the events are recorded correctly
4. Verify that playback of the events are correct
5. Schedule recordings from EPG as per the initial situation.
6. Update the EIT in a way that the events that will be overlapping
7. Verify that the events are recorded correctly (the earlier recording has the priority)
8. Verify that playback of the events are correct

**Expected results:**

The IRD handles back-to-back recording correctly with dynamic update of EIT information

<i>Test result(s)</i>	Measurement record:	
	<b>Test point</b>	<b>Result OK/NOK</b>
	IRD records back-to-back events correctly from	
	- the same service	
	- different services on same multiplex	
	- different services on different multiplexes	
	IRD records overlapping events correctly from	
	- the same service	
- different services on same multiplex		
- different services on different multiplexes		
IRD handles possible recording conflicts correctly		
<i>Conformity</i>	<input type="checkbox"/> OK <input type="checkbox"/> Fault <input type="checkbox"/> Major <input type="checkbox"/> Minor, define fail reason in comments	
<i>Comments</i>	If possible describe if fault can be fixed with software update: <input type="checkbox"/> YES <input type="checkbox"/> NO Describe more specific faults and/or other information	
<i>Date</i>		<i>Sign</i>

<b>Task 15:30 Timeshift recording</b>							
<b>Section</b>	NorDig Unified 14.3.12						
<b>Requirement</b>	The NorDig PVR shall be able to pause or timeshift live TV for at least 60 minutes. It should be possible to save time-shifted events into the PVR list of recordings.						
<b>IRD Profile(s)</b>	Basic, PVR, IRD, FE						
<b>Test procedure</b>	<p><b>Purpose of test:</b> To verify that IRD supports timeshift recording.</p> <p><b>Equipment:</b></p> <ul style="list-style-type: none"> <li>• IRD Under test</li> <li>• Live stream or test network with SD and HD services, containing video, multiple audio and multiple subtitling components and teletext</li> </ul> <p><b>Test procedure:</b></p> <ol style="list-style-type: none"> <li>1. Pause the live view on a channel</li> <li>2. Verify that the IRD is able to timeshift for at least 60 minutes.</li> <li>3. Start the viewing of paused content.</li> <li>4. Verify that the timeshifted content is played out correctly and all components are available.</li> </ol> <p><b>Expected result:</b> The paused content can be viewed from the point where the broadcast was paused by pressing a single button and the trick modes can be used in chased playback.</p>						
<b>Test result(s)</b>	<p>Measurement record</p> <table border="1"> <thead> <tr> <th>Test point</th> <th>Result OK/NOK</th> </tr> </thead> <tbody> <tr> <td>Timeshift duration is at least 60 minutes</td> <td></td> </tr> <tr> <td>IRD is able to play back all service components in time-shift</td> <td></td> </tr> </tbody> </table>	Test point	Result OK/NOK	Timeshift duration is at least 60 minutes		IRD is able to play back all service components in time-shift	
Test point	Result OK/NOK						
Timeshift duration is at least 60 minutes							
IRD is able to play back all service components in time-shift							
<b>Conformity</b>	<input type="checkbox"/> OK <input type="checkbox"/> Fault <input type="checkbox"/> Major <input type="checkbox"/> Minor, define fail reason in comments						
<b>Comments</b>	If possible describe if fault can be fixed with software update: <input type="checkbox"/> YES <input type="checkbox"/> NO Describe more specific faults and/or other information						
<b>Date</b>	<b>Sign</b>						

<b>Task 15:31 Manual recording</b>	
<b>Section</b>	NorDig Unified 14.3.14
<b>Requirement</b>	<p>The NorDig PVR shall make it possible for the viewer to set a manual recording, without using the EPG/ESG/EIT data, by setting the service, start-time and end-time (or duration).</p> <p>The time and date for the user when programming shall be the local time, including any offset, at the time of recording according to the IRD's settings, and not the local time at the time of programming. This means that if there is a change in local time offset (e.g. change in daylight-saving time) between the time of programming and the time of recording, the time and date shall refer to the new local time at the time of recording.</p> <p>It should be possible to set weekly repeated manual recording (like every Monday 19:00:00 to 20:00:00 or every weekday between 12:00:00 to 12:15:00)</p>
<b>IRD Profile(s)</b>	Basic, PVR, IRD, FE
<b>Test procedure</b>	<p><b>Purpose of test:</b> To verify that IRD</p> <p><b>Equipment:</b></p>

	<ul style="list-style-type: none"> <li>• IRD Under test</li> <li>• Live stream or test network with SD and HD services, containing video, multiple audio and multiple subtitling components and teletext</li> </ul> <p><b>Test procedure:</b></p> <ol style="list-style-type: none"> <li>1. Schedule a recording by setting a manual timer.</li> <li>2. Playback recording initiated by the manual timer</li> </ol> <p><b>Expected result:</b></p> <p>The IRD is able to initiate recordings using manual timers.</p>
<b>Test result(s)</b>	
<b>Conformity</b>	<input type="checkbox"/> <b>OK</b> <input type="checkbox"/> <b>Fault</b> <input type="checkbox"/> Major <input type="checkbox"/> Minor, define fail reason in comments
<b>Comments</b>	If possible describe if fault can be fixed with software update: <input type="checkbox"/> <b>YES</b> <input type="checkbox"/> <b>NO</b> Describe more specific faults and/or other information
<b>Date</b>	<b>Sign</b>

	<b>Task 15:32 Manual recording – Changes in TDT/TOT</b>
<b>Section</b>	NorDig Unified 14.3.14
<b>Requirement</b>	<p>The NorDig PVR shall make it possible for the viewer to set a manual recording, without using the EPG/ESG/EIT data, by setting the service, start-time and end-time (or duration).</p> <p>The time and date for the user when programming shall be the local time, including any offset, at the time of recording according to the IRD's settings, and not the local time at the time of programming. This means that if there is a change in local time offset (e.g. change in daylight-saving time) between the time of programming and the time of recording, the time and date shall refer to the new local time at the time of recording.</p> <p>It should be possible to set weekly repeated manual recording (like every Monday 19:00:00 to 20:00:00 or every weekday between 12:00:00 to 12:15:00)</p>
<b>IRD Profile(s)</b>	Basic, PVR, IRD, FE
<b>Test procedure</b>	<p><b>Purpose of test:</b></p> <p>To verify that IRD supports daylight saving changes.</p> <p><b>Equipment:</b></p> <ul style="list-style-type: none"> <li>• IRD Under test</li> <li>• Live stream or test network having a time offset change</li> </ul> <p><b>Test procedure:</b></p> <ol style="list-style-type: none"> <li>1. Schedule a recording for an event after the time offset change indicated in the time_of_change field in the local_time_offset_descriptor of TOT.</li> <li>2. Set the IRD to standby.</li> <li>3. Wait until the time event for the time offset change has been passed.</li> <li>4. Resume the IRD from standby.</li> <li>5. Verify that the recording start time and duration are correctly as scheduled.</li> <li>6. Verify that the recording is played back correctly.</li> </ol> <p><b>Expected result:</b></p> <p>The IRD is able to initiate recordings using manual timers and recording is according summer/wintertime change correctly.</p>



<b>Test result(s)</b>	Measurement record	
	<b>Test point</b>	<b>Result OK/NOK</b>
	Scheduled recordings are planned for the local time during the recording	
	IRD is able to perform manual recordings correctly when time offset decreases	
	IRD is able to perform manual recordings correctly when time offset increases	
<b>Conformity</b>	<input type="checkbox"/> <b>OK</b> <input type="checkbox"/> <b>Fault</b> <input type="checkbox"/> Major <input type="checkbox"/> Minor, define fail reason in comments	
<b>Comments</b>	If possible describe if fault can be fixed with software update: <input type="checkbox"/> <b>YES</b> <input type="checkbox"/> <b>NO</b> Describe more specific faults and/or other information	
<b>Date</b>		<b>Sign</b>

	<b>Task 15:33 One Touch Recording (OTR)</b>	
<b>Section</b>	NorDig Unified 14.3.15	
<b>Requirement</b>	<p>The NorDig PVR shall include a direct recording setting as a One-touch recording (OTR) function which allows the user to start a recording, while watching live TV, with one button press on the remote control.</p> <p>This One-touch recording shall not be delayed by further requests for user interaction unless to proceed would affect a recording that is either already underway or scheduled to start before the end of the OTR recording.</p> <p>The duration of the One-touch recording operation shall be based on either a pre-set time or current viewed event.</p>	
<b>IRD Profile(s)</b>	Basic, PVR, IRD, FE	
<b>Test procedure</b>	<p><b>Purpose of test:</b> To verify that IRD supports one-touch recording.</p> <p><b>Equipment:</b></p> <ul style="list-style-type: none"> <li>• IRD Under test</li> <li>• Live stream or test network</li> </ul> <p><b>Test procedure:</b></p> <ol style="list-style-type: none"> <li>1. Watch a channel for a few minutes</li> <li>2. Press record button to start recording.</li> <li>3. Wait for a few minutes.</li> <li>4. Stop recording using the remote control button for 'stop'.</li> <li>5. Press again record button for OTR.</li> <li>6. Change volume, view teletext and toggle between different available subtitling and audio components. Set the IRD to stand-by and wake it up.</li> <li>7. Wait until the default recording duration has exceed.</li> <li>8. View the recordings.</li> <li>9. Fill in the measurement record.</li> </ol> <p><b>Expected result:</b> The IRD is able to initiate a recording by pressing dedicated record button</p>	
<b>Test result(s)</b>	Measurement record	
	<b>Test point</b>	<b>Result OK/NOK</b>
	IRD begins the OTR immediately after user has pressed the 'Record' button unless overridden by conflict handling.	
	OTR default duration is either a pre-set time or until the end of the event.	
	OTR is automatically stopped after default duration has exceed.	



	OTR is not disturbed by user actions.	
<b>Conformity</b>	<input type="checkbox"/> <b>OK</b> <input type="checkbox"/> <b>Fault</b> <input type="checkbox"/> Major <input type="checkbox"/> Minor, define fail reason in comments	
<b>Comments</b>	If possible describe if fault can be fixed with software update: <input type="checkbox"/> <b>YES</b> <input type="checkbox"/> <b>NO</b> Describe more specific faults and/or other information	
<b>Date</b>		<b>Sign</b>

	<b>Task 15:34 Automatic Conflict Handling – During programming</b>											
<b>Section</b>	NorDig Unified 14.3.16.1											
<b>Requirement</b>	<p>If a conflict is detected it shall be indicated immediately to the user, together with details of the cause, so that the user can take appropriate action.</p> <p>When programming a recording which comes in conflict with an earlier programmed recording and when the NorDig PVR can detect an alternative instance in one or both of them, the NorDig PVR shall either automatically re-program one of the to the alternative instance or propose that viewer solve the conflict by moving one of the recordings to the alternative instance and asking for confirmation.</p>											
<b>IRD Profile(s)</b>	Basic, PVR, IRD, FE											
<b>Test procedure</b>	<p><b>Purpose of test:</b> To verify that IRD detects conflict in during recordings programming</p> <p><b>Equipment:</b> IRD Under test Live signal or test streams with EIT information containing overlapping events. Conflicting events shall be tested also as signaled with alternative instances, if supported by the broadcaster.</p> <p><b>Test procedure:</b></p> <ol style="list-style-type: none"> <li>1. Watch a channel for a few minutes</li> <li>2. Schedule an event ‘Event1’ with start_time1 and duration1 for recording from ESG/EPG.</li> <li>3. Schedule an another event on a different channel on the same multiplex that will overlap with the previous recording causing a conflict in the IRD recording resources.             <ol style="list-style-type: none"> <li>a. Event with start_time2 = start_time1</li> <li>b. Event with start_time2 &lt; start_time1</li> <li>c. Event with start_time2 &gt; start_time1</li> <li>d. Event with start_time2 &lt; start_time1 and start_time2+duration2 &gt; start_time1+duration1</li> <li>e. Event with start_time2 &gt; start_time1 and start_time2+duration2 &lt; start_time1+duration1</li> </ol> </li> <li>4. Repeat the test with events on a different multiplex</li> <li>5. Fill in the measurement record.</li> </ol> <p><b>Expected results:</b> The IRD detects conflict during programming of the recordings</p>											
<b>Test result(s)</b>	<p>Measurement record</p> <table border="1"> <thead> <tr> <th>Test point</th> <th>Status OK/NOK</th> </tr> </thead> <tbody> <tr> <td>IRD indicates overlapping scheduled recordings on same multiplex immediately when the conflict is detected</td> <td></td> </tr> <tr> <td>IRD indicates overlapping scheduled recordings on different multiplexes immediately when the conflict is detected</td> <td></td> </tr> <tr> <td>IRD proposes to adjust the overlapping recordings or proposes automatically a new instance of the same event</td> <td></td> </tr> <tr> <td>Conflict indication includes details of the cause.</td> <td></td> </tr> </tbody> </table>		Test point	Status OK/NOK	IRD indicates overlapping scheduled recordings on same multiplex immediately when the conflict is detected		IRD indicates overlapping scheduled recordings on different multiplexes immediately when the conflict is detected		IRD proposes to adjust the overlapping recordings or proposes automatically a new instance of the same event		Conflict indication includes details of the cause.	
Test point	Status OK/NOK											
IRD indicates overlapping scheduled recordings on same multiplex immediately when the conflict is detected												
IRD indicates overlapping scheduled recordings on different multiplexes immediately when the conflict is detected												
IRD proposes to adjust the overlapping recordings or proposes automatically a new instance of the same event												
Conflict indication includes details of the cause.												



<b>Conformity</b>	<input type="checkbox"/> OK <b>Fault</b> <input type="checkbox"/> Major <input type="checkbox"/> Minor, define fail reason in comments
<b>Comments</b>	If possible describe if fault can be fixed with software update: <input type="checkbox"/> YES <input type="checkbox"/> NO Describe more specific faults and/or other information
<b>Date</b>	<b>Sign</b>

	<b>Task 15:35 Automatic Conflict Handling – After programming</b>
<b>Section</b>	NorDig Unified 14.3.16.2
<b>Requirement</b>	<p>If the NorDig PVR has a number of active programmed series recordings and if there occurs a request of more simultaneous recordings than the NorDig PVR is capable of handling, the NorDig PVR shall be able to handle this without user confirmation at the time of actual recording, i.e. the IRD may inform of the conflict via the OSD but shall automatically solve the conflict at the time of actual recording if the user does not manually change the conflict handling.</p> <p>Any information on OSD about conflict shall not be included in recording and shall have a time-out if no user reaction. All requests for user confirmation shall be done during the time of programming or during the setting of user preferences.</p> <p>The conflict(s) shall be solved with higher priority recordings having preference before recordings with a lower priority. It is up to the NorDig PVR manufacture to define the PVR's priority list, however it may typically be as prioritised in Table 14.1. Conflict(s) of recording with same priority level shall also be automatically solved (at least one of them shall be recorded), but it is up to the NorDig PVR manufacture to define a mechanism. The NorDig PVR should offer for the user the ability to change the conflict priority in the user preferences.</p>
<b>IRD Profile(s)</b>	Basic, PVR, IRD, FE
<b>Test procedure</b>	<p><b>Purpose of test:</b> To verify that IRD detects conflict in during recording</p> <p><b>Equipment:</b> IRD Under test Live signal or test streams with EIT information updated to have overlapping events. Conflicting events shall be tested also as signalized with alternative instances, if supported by the broadcaster.</p> <p><b>Test procedure:</b></p> <ol style="list-style-type: none"> <li>1. Watch a channel for a few minutes.</li> <li>2. Schedule an event 'Event' with start_time and duration for recording from ESG/EPG.</li> <li>3. Start OTR on a different channel on the same multiplex that will overlap with the previous recording causing a conflict in the IRD recording resources.             <ol style="list-style-type: none"> <li>a. OTR is started before start_time</li> <li>b. OTR is started after start_time</li> </ol> </li> <li>4. Repeat the test with events on different multiplexes.</li> <li>5. Fill in the measurement record.</li> </ol> <p><b>Expected results:</b> The IRD detects conflict during recording and resolves the conflict automatically</p>



<i>Test result(s)</i>	Measurement record	
	<b>Test point</b>	<b>Status OK/NOK</b>
	IRD indicates if recording is overlapping with scheduled recordings on the same multiplex	
	IRD indicates if recording is overlapping with scheduled recordings on different multiplexes	
	OSD about conflict has a time-out and IRD adjusts the overlapping recordings or re-programs automatically a new instance of the same event unless overridden by user actions. Automatic conflict handling does not disturb the recording with higher priority.	
<i>Conformity</i>	<input type="checkbox"/> <b>OK</b> <input type="checkbox"/> <b>Fault</b> <input type="checkbox"/> Major <input type="checkbox"/> Minor, define fail reason in comments	
<i>Comments</i>	If possible describe if fault can be fixed with software update: <input type="checkbox"/> <b>YES</b> <input type="checkbox"/> <b>NO</b> Describe more specific faults and/or other information	
<i>Date</i>		<i>Sign</i>

	<b>Task 15:36 Maximum length of recordings</b>	
<i>Section</i>	NorDig Unified 14.3.17	
<i>Requirement</i>	<p>If there is a failure within the transmission of the EIT and other transmission errors, the NorDig PVR shall stop recording 4 hours after scheduled duration of the event has passed (even if the event still appears in EIT present table).</p> <p>For events that have a duration that is longer than 8 hours, the NorDig PVR may stop recording after 8 hours.</p>	
<i>IRD Profile(s)</i>	Basic, PVR, IRD, FE	
<i>Test procedure</i>	<p><b>Purpose of test:</b> To verify that IRD records maximum time specified.</p> <p><b>Equipment:</b> IRD Under test Stream or live network with EIT information</p> <p><b>Test procedure:</b></p> <ol style="list-style-type: none"> <li>1. Schedule an event for recording that has duration of more than 8 hours.</li> <li>2. Verify that IRD has recorded the event for at least 8 hours</li> <li>3. Schedule an event (less than 4 hours) and take a note of the ending time of the event.</li> <li>4. Remove EIT information.</li> <li>5. Verify that IRD stops recording 4 hours after the original end time of the event.</li> <li>6. Schedule an event (more than 4 hours) and take a note of the ending time of the event.</li> <li>7. Remove EIT information.</li> <li>8. Verify that IRD stops recording 4 hours after the original end time or 8 hours after from the beginning of the recording.</li> </ol> <p><b>Expected results:</b> The IRD handles max. length of recordings.</p>	
<i>Test result(s)</i>		
<i>Conformity</i>	<input type="checkbox"/> <b>OK</b> <input type="checkbox"/> <b>Fault</b> <input type="checkbox"/> Major <input type="checkbox"/> Minor, define fail reason in comments	





<b>Comments</b>	If possible describe if fault can be fixed with software update: <input type="checkbox"/> YES <input type="checkbox"/> NO Describe more specific faults and/or other information		
<b>Date</b>		<b>Sign</b>	

	<b>Task 15:37 Recording of parallel broadcast</b>		
<b>Section</b>	NorDig Unified 14.3.19		
<b>Requirement</b>	Some services and events are parallel broadcasted in multiple versions. In this context a parallel broadcast of same programme event is identified that all service's events have the same programme_CRID. Examples of parallel broadcasts are services with same national content but with different regional content and services with same content but with different resolution ie SD and HD simulcast broadcast services. The NorDig IRD that has been programmed to record an event with a specific programme_crid or series_crid which a programme_crid is part of, shall only record one instance of the event from one of the services when the event is parallel broadcasted over several services at the same time.		
<b>IRD Profile(s)</b>	Basic, PVR, IRD, FE		
<b>Test procedure</b>	<p><b>Purpose of test:</b> To verify that IRD handles recordings with parallel broadcasts.</p> <p><b>Equipment:</b> IRD Under test Live stream or test network with EIT information. The network shall have simultaneous parallel broadcasts of events with equal programme_crid.</p> <p><b>Test procedure:</b></p> <ol style="list-style-type: none"> <li>Schedule an event with multiple parallel broadcasts for recording.</li> <li>Verify that IRD records only one of the event instances.</li> </ol> <p><b>Expected results:</b> The IRD handles recordings with parallel broadcasts.</p>		
<b>Test result(s)</b>			
<b>Conformity</b>	<input type="checkbox"/> OK <b>Fault</b> <input type="checkbox"/> Major <input type="checkbox"/> Minor, define fail reason in comments		
<b>Comments</b>	If possible describe if fault can be fixed with software update: <input type="checkbox"/> YES <input type="checkbox"/> NO Describe more specific faults and/or other information		
<b>Date</b>		<b>Sign</b>	

	<b>Task 15:38 Playback - General</b>		
<b>Section</b>	NorDig Unified 14.4.1		
<b>Requirement</b>	The NorDig PVR shall be able to playback recordings of all supported service types (TV, radio etc) and all belonging components/PIDs (as described in 14.4.5). Only the service related interactive applications from the current viewed service (live or playback) are required to be active, this means that during playback all interactive applications from the live service in the background may be terminated.		
<b>IRD Profile(s)</b>	Basic, PVR, IRD, FE		

<b>Test procedure</b>	<p><b>Purpose of test:</b> To verify that IRD is able to play back the recordings it has performed with all belonging components/PIDs.</p> <p><b>Equipment:</b> IRD Under test Live stream or test network.</p> <p><b>Test procedure:</b>  The requirement in this test will be verified in the following test tasks.</p> <p><b>Expected results:</b> IRD is successfully able to play back the recordings.</p>
<b>Test result(s)</b>	
<b>Conformity</b>	<input type="checkbox"/> <b>OK</b> <input type="checkbox"/> <b>Fault</b> <input type="checkbox"/> Major <input type="checkbox"/> Minor, define fail reason in comments
<b>Comments</b>	If possible describe if fault can be fixed with software update: <input type="checkbox"/> <b>YES</b> <input type="checkbox"/> <b>NO</b> Describe more specific faults and/or other information
<b>Date</b>	<b>Sign</b>

	<b>Task 15:39 Replay/Playback – trick modes in playback</b>
<b>Section</b>	NorDig Unified 14.4.2
<b>Requirement</b>	<p>The NorDig PVR shall support the following trick modes during playback of recorded events (incl timeshift) for all supported video formats/codecs:</p> <ul style="list-style-type: none"> <li>• Play (playback at normal speed)</li> <li>• Pause</li> <li>• Stop (stop may be combined with pause, but must enable an easy way to stop playback and return to list of recordings and live viewing mode)</li> <li>• Fast forward and shall support fast forward at minimum 3 different speeds, (like x3, x6, x15 and x30).</li> <li>• Fast reverse and should support fast reverse at minimum 3 different speeds, (like x3, x6, x15 and x30).</li> </ul>
<b>IRD Profile(s)</b>	Basic, PVR, IRD, FE
<b>Test procedure</b>	<p><b>Purpose of test:</b> To verify that IRD handles correctly different trick modes in playback.</p> <p><b>Equipment:</b> IRD Under test Live stream or test network.</p> <p><b>Test procedure:</b></p> <ol style="list-style-type: none"> <li>1. Play back recordings with different kinds of video, audio and subtitling components.</li> <li>2. Pause and resume the playback. Repeat for several times with various durations, from few seconds up to several minutes.</li> <li>3. Fast forward the recording. Toggle between different FF speeds. Resume playback from each available FF speed.</li> <li>4. Rewind the recording. Toggle between different REW speeds, if available. Resume playback from each available REW speed.</li> <li>5. Stop the playback.</li> <li>6. Fill in the measurement record.</li> </ol> <p><b>Expected results:</b> The IRD handles different trick modes. Playback is not disturbed by usage of the trick modes.</p>



<b>Test result(s)</b>	Measurement record	
	<b>Test point</b>	<b>Result OK/NOK</b>
	IRD has Pause mode in playback and it works correctly.	
	IRD has 3 or more different FF speeds.	
	IRD has REW functionality (with 1 or more speeds)	
<b>Conformity</b>	<input type="checkbox"/> <b>OK</b> <input type="checkbox"/> <b>Fault</b> <input type="checkbox"/> Major <input type="checkbox"/> Minor, define fail reason in comments	
<b>Comments</b>	If possible describe if fault can be fixed with software update: <input type="checkbox"/> <b>YES</b> <input type="checkbox"/> <b>NO</b> Describe more specific faults and/or other information	
<b>Date</b>		<b>Sign</b>

	<b>Task 15:40 Replay/Playback – trick modes in timeshift</b>	
<b>Section</b>	NorDig Unified 14.4.2	
<b>Requirement</b>	The NorDig PVR shall support the following trick modes during playback of recorded events (incl timeshift) for all supported video formats/codecs: <ul style="list-style-type: none"> <li>· Play (playback at normal speed)</li> <li>· Pause</li> <li>· Stop (stop may be combined with pause, but must enable an easy way to stop playback and return to list of recordings and live viewing mode)</li> <li>· Fast forward and shall support fast forward at minimum 3 different speeds, (like x3, x6, x15 and x30).</li> <li>· Fast reverse and should support fast reverse at minimum 3 different speeds, (like x3, x6, x15 and x30).</li> </ul>	
<b>IRD Profile(s)</b>	Basic, PVR, IRD, FE	
<b>Test procedure</b>	<p><b>Purpose of test:</b> To verify that IRD handles correctly different trick modes in timeshift.</p> <p><b>Equipment:</b> IRD Under test Live stream or test network.</p> <p><b>Test procedure:</b></p> <ol style="list-style-type: none"> <li>1. Timeshift services with different kinds of video, audio and subtitling components.</li> <li>2. Pause and resume the timeshift. Repeat for several times with various durations, from few seconds up to several minutes.</li> <li>3. Fast forward the timeshift. Toggle between different FF speeds. Resume timeshift viewing from each available FF speed.</li> <li>4. Fast forward until timeshift reaches the real time.</li> <li>5. Rewind the timeshift. Toggle between different REW speeds, if available. Resume playback from each available REW speed.</li> <li>6. Stop the timeshift.</li> <li>7. Fill in the measurement record.</li> </ol> <p><b>Expected results:</b> The IRD handles different trick modes. Playback is not disturbed by usage of the trick modes.</p>	
<b>Test result(s)</b>	Measurement record	
	<b>Test point</b>	<b>Result OK/NOK</b>
	IRD supports 3 or more different FF speeds in timeshift.	
	IRD supports REW functionality (with 1 or more speeds) in timeshift	
	Chase fast forward works correctly	
<b>Conformity</b>	<input type="checkbox"/> <b>OK</b> <input type="checkbox"/> <b>Fault</b> <input type="checkbox"/> Major <input type="checkbox"/> Minor, define fail reason in comments	



<b>Comments</b>	If possible describe if fault can be fixed with software update: <input type="checkbox"/> YES <input type="checkbox"/> NO Describe more specific faults and/or other information	
<b>Date</b>	<b>Sign</b>	

	<b>Task 15:41 Relative synchronisation</b>											
<b>Section</b>	NorDig Unified 14.4.3											
<b>Requirement</b>	The NorDig PVRs shall not introduce more relative delay (reduced “lipsync”) during playback between the audio, video and other PES packetised components (like subtitling) compared to decoding of live content, measured 5s or later after start of normal playback (see chapter 6.1.2.1 and 7). After using trick mode the relative delay shall meet the requirements within 5s after resuming back to normal playback speed.											
<b>IRD Profile(s)</b>	Basic, PVR, IRD, FE											
<b>Test procedure</b>	<p><b>Purpose of test:</b> To verify that IRD sustains the ‘lipsync’ during playback and time-shift.</p> <p><b>Equipment:</b> IRD Under test Live stream or test network.</p> <p><b>Test procedure:</b></p> <p><b>The requirement in this test can be verified in parallel with the other 15:xx tasks. Subtitling synchronization is tested in tasks 15:49 and 15:50.</b></p> <ol style="list-style-type: none"> <li>1. Play back recordings with different video, audio and subtitling components.</li> <li>2. Compare the relative delay of video and audio in playback with the live content.</li> <li>3. Compare the relative delay of video and audio in timeshift with the live content.</li> <li>4. Fill in the measurement record.</li> </ol> <p><b>Expected results:</b> The IRD recovers the ‘lipsync’ during normal playback mode and time-shift after 5s.</p>											
<b>Test result(s)</b>	<table border="1" style="width: 100%;"> <tr> <td colspan="2">Measurement record</td> </tr> <tr> <td style="background-color: #cccccc;"><b>Test point</b></td> <td style="background-color: #cccccc;"><b>Result OK/NOK</b></td> </tr> <tr> <td>Video and audio components are played back in sync compared with the live content.</td> <td></td> </tr> <tr> <td>Video and audio components are played back in timeshift in sync compared with the live content.</td> <td></td> </tr> <tr> <td>Synchronization of video and audio components is settled after changing from a trick mode to normal playback speed within 5 seconds.</td> <td></td> </tr> </table>		Measurement record		<b>Test point</b>	<b>Result OK/NOK</b>	Video and audio components are played back in sync compared with the live content.		Video and audio components are played back in timeshift in sync compared with the live content.		Synchronization of video and audio components is settled after changing from a trick mode to normal playback speed within 5 seconds.	
Measurement record												
<b>Test point</b>	<b>Result OK/NOK</b>											
Video and audio components are played back in sync compared with the live content.												
Video and audio components are played back in timeshift in sync compared with the live content.												
Synchronization of video and audio components is settled after changing from a trick mode to normal playback speed within 5 seconds.												
<b>Conformity</b>	<input type="checkbox"/> OK <input type="checkbox"/> Fault <input type="checkbox"/> Major <input type="checkbox"/> Minor, define fail reason in comments											
<b>Comments</b>	If possible describe if fault can be fixed with software update: <input type="checkbox"/> YES <input type="checkbox"/> NO Describe more specific faults and/or other information											
<b>Date</b>	<b>Sign</b>											

<b>Test Case</b>	<b>Task 15:42 Full service playback – Dynamic update of PMT audio language</b>
<b>Section</b>	NorDig Unified 14.4.5
<b>Requirement</b>	During playback of recorded content the user shall be able to perform the same full service selection as would have been possible during basic live viewing, such as select

audio and/or subtitling language (if several components with same type are available), switch subtitling on or off, select audio format etc (with the limitation outlined in section 14.3.9). The basic live viewing refers to all streams excluding any HbbTV related streams. Dynamic changes in the services (such as a change of video aspect ratio or change of audio format) that occur during the recording shall be processed in the same way as during live viewing.

During playback the NorDig PVR shall be able to set the same control as during live viewing, for example blanking of video and muting of sound depending on the event's parental rating values (see 14.3.2) and signal protection (HDCP) on its digital output interface (see 9.9.4). For cases where the information is coming from EIT data (like parental rating descriptor), the playback shall at least act on the EIT signalling at the start of the recording (see 15.2.1). For the cases where the information is coming from PMT or the elementary streams (like signal protection and aspect ratio), the playback shall perform the same as live viewing and following any changes therein (i.e. PMT and elementary stream header information shall be stored and processed during playback).

**IRD Profile(s)** Basic, PVR, IRD, FE

**Test procedure** **Purpose of test:**  
To verify that receiver that the Receiver handles the dynamic update of certain PSI/SI tables.

**Test Equipment:**

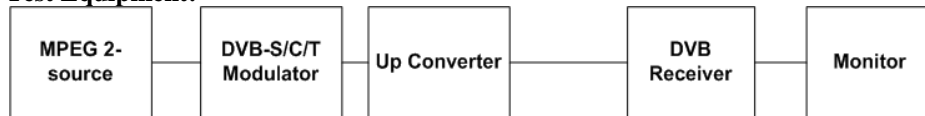

<b>MUX1</b> TS_id 1 Network_id 1 ON_id <sup>1)</sup>	<b>Service1</b> SID 1100 S_name Test11 S_type 0x01 PMT PID 1100 V PID 1109 (MPEG2 SD) A PID 1108 (MPEG1L2) A PID 1107 (MPEG1L2) LCN 1 visible	<b>Service2</b> SID 1200 S_name Test12 S_type 0x16 or 0x19 PMT PID 1200 V PID 1209 (MPEG4 AVC) A PID 1208 (AC-3/E-AC-3 or HE-AAC) A PID 1207 (AC-33/E-AC-3 or HE-AAC) LCN 2 visible	Bouquet SI All information in EIT.	Can be chosen depending of the distribution media.
---------------------------------------------------------------	-----------------------------------------------------------------------------------------------------------------------------------------------------------------------	-------------------------------------------------------------------------------------------------------------------------------------------------------------------------------------------------------------	---------------------------------------	----------------------------------------------------

<sup>1)</sup> ON\_id (Original\_network\_id) can be chosen in range 0x0001-0xfe00 (operational network) and it shall be same for both muxes

Services may contain other components, e.g. teletext, subtitling and multiple additional audio tracks.

PMT of the test services shall be updated during the test so that audio components are added and removed in various combinations, e.g. by the following pattern:

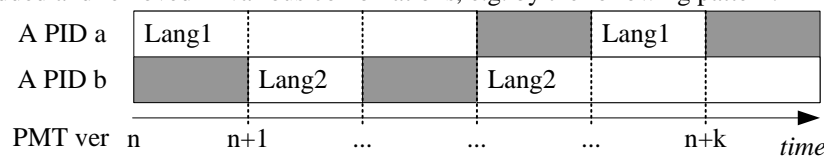

**Test procedure:**

1. Set the user preference for primary audio language to Lang1.
2. Set the user preference for secondary audio language to other than Lang1 or Lang2.
3. Start recording.
4. Select an another service.
5. Update the PMT table of the service and add/remove audio component(s).
6. Stop the recording.
7. Set the user preference for primary audio language to other than Lang1 or

	<p>Lang2 and secondary audio language to Lang2.</p> <p>8. Play back the recording.</p> <p>9. Fill in the measurement record.</p> <p><b>Expected results:</b> The receiver shall handle updates in PMT and record/playback according to the signaling. All decodable components in PMT have been recorded. User preference for primary/secondary audio language works correctly in playback.</p>										
<b>Test result(s)</b>	<p>Measurement record:</p> <table border="1"> <thead> <tr> <th>Test point</th> <th>Result OK/NOK</th> </tr> </thead> <tbody> <tr> <td>IRD records all decodable audio components in the service</td> <td></td> </tr> <tr> <td>User preference for primary/secondary audio language works correctly in playback.</td> <td></td> </tr> <tr> <td>Audio track is selected for playback dynamically by the PMT</td> <td></td> </tr> <tr> <td>PMT update and consequent audio track selection do not disturb the playback of other components.</td> <td></td> </tr> </tbody> </table>	Test point	Result OK/NOK	IRD records all decodable audio components in the service		User preference for primary/secondary audio language works correctly in playback.		Audio track is selected for playback dynamically by the PMT		PMT update and consequent audio track selection do not disturb the playback of other components.	
Test point	Result OK/NOK										
IRD records all decodable audio components in the service											
User preference for primary/secondary audio language works correctly in playback.											
Audio track is selected for playback dynamically by the PMT											
PMT update and consequent audio track selection do not disturb the playback of other components.											
<b>Conformity</b>	<input type="checkbox"/> <b>OK Fault</b> <input type="checkbox"/> Major <input type="checkbox"/> Minor, define fail reason in comments										
<b>Comments</b>	<p>If possible describe if fault can be fixed with software update: <input type="checkbox"/> <b>YES</b> <input type="checkbox"/> <b>NO</b></p> <p>Describe more specific faults and/or other information</p>										
<b>Date</b>	<table border="1"> <tr> <td></td> <td><i>Sign</i></td> <td></td> </tr> </table>		<i>Sign</i>								
	<i>Sign</i>										

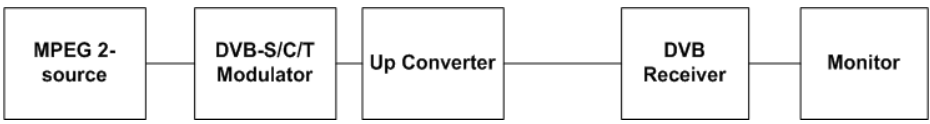
<b>Test Case</b>	<b>Task 15:43 Full service playback – Dynamic update of PMT audio format</b>
<b>Section</b>	NorDig Unified 14.4.5
<b>Requirement</b>	<p>During playback of recorded content the user shall be able to perform the same full service selection as would have been possible during basic live viewing, such as select audio and/or subtitling language (if several components with same type are available), switch subtitling on or off, select audio format etc (with the limitation outlined in section 14.3.9). The basic live viewing refers to all streams excluding any HbbTV related streams. Dynamic changes in the services (such as a change of video aspect ratio or change of audio format) that occur during the recording shall be processed in the same way as during live viewing.</p> <p>During playback the NorDig PVR shall be able to set the same control as during live viewing, for example blanking of video and muting of sound depending on the event's parental rating values (see 14.3.2) and signal protection (HDCP) on its digital output interface (see 9.9.4). For cases where the information is coming from EIT data (like parental rating descriptor), the playback shall at least act on the EIT signalling at the start of the recording (see 15.2.1). For the cases where the information is coming from PMT or the elementary streams (like signal protection and aspect ratio), the playback shall perform the same as live viewing and following any changes therein (i.e. PMT and elementary stream header information shall be stored and processed during playback).</p>
<b>IRD Profile(s)</b>	Basic, PVR, IRD, FE
<b>Test procedure</b>	<p><b>Purpose of test:</b> To verify that receiver that the Receiver handles the dynamic update of certain PSI/SI tables.</p> <p><b>Test Equipment:</b></p> <div style="text-align: center;">  <pre> graph LR     A[MPEG 2-source] --&gt; B[DVB-S/C/T Modulator]     B --&gt; C[Up Converter]     C --&gt; D[DVB Receiver]     D --&gt; E[Monitor]           </pre> </div> <p>MPEG-2 source must have capability to support dynamic changes in audio components within service(s).</p>

	<p>In case of dual-channel audio the first language_descriptor definition corresponds physical left channel and second language_descriptor definition corresponds physical right channel.</p> <p>This test task can be performed in parallel with Task 7:28 Dynamic changes in audio components.</p> <p><b>Test procedure:</b></p> <ol style="list-style-type: none"> <li>1. Start recording.</li> <li>2. Use MPEG-2 source to generate dynamic changes in audio components as listed in test results</li> <li>3. Play back the recording.</li> <li>4. Fill in the test results.</li> </ol> <p><b>Expected result:</b></p> <p>IRD is able to handle dynamic changes in audio components in playback.</p>																		
<b>Test result(s)</b>	<p>Measurement record:</p> <table border="1"> <thead> <tr> <th>Test point</th> <th>NOK or OK</th> </tr> </thead> <tbody> <tr> <td>Change of number of audio channels within same audio codec (eg. AC-3 2.0 to AC-3 5.1 and vice versa.</td> <td></td> </tr> <tr> <td>Change of bitrate for an audio component (eg. MPEG1-L2 bitrate from 192 kbps to 160 kbps)</td> <td></td> </tr> <tr> <td>Change of audio PID value (any codec)</td> <td></td> </tr> <tr> <td>Change from dual-channel audio into stereo audio and vice versa</td> <td></td> </tr> <tr> <td>Removal of selected audio component and using the next preferred one</td> <td></td> </tr> <tr> <td>Addition of one audio component with higher preferred user setting</td> <td></td> </tr> <tr> <td>Change of the audio codec (eg. from MPEG1-L2 to AC-3</td> <td></td> </tr> <tr> <td>Change of ISO 639-2 language for an audio component</td> <td></td> </tr> </tbody> </table>	Test point	NOK or OK	Change of number of audio channels within same audio codec (eg. AC-3 2.0 to AC-3 5.1 and vice versa.		Change of bitrate for an audio component (eg. MPEG1-L2 bitrate from 192 kbps to 160 kbps)		Change of audio PID value (any codec)		Change from dual-channel audio into stereo audio and vice versa		Removal of selected audio component and using the next preferred one		Addition of one audio component with higher preferred user setting		Change of the audio codec (eg. from MPEG1-L2 to AC-3		Change of ISO 639-2 language for an audio component	
Test point	NOK or OK																		
Change of number of audio channels within same audio codec (eg. AC-3 2.0 to AC-3 5.1 and vice versa.																			
Change of bitrate for an audio component (eg. MPEG1-L2 bitrate from 192 kbps to 160 kbps)																			
Change of audio PID value (any codec)																			
Change from dual-channel audio into stereo audio and vice versa																			
Removal of selected audio component and using the next preferred one																			
Addition of one audio component with higher preferred user setting																			
Change of the audio codec (eg. from MPEG1-L2 to AC-3																			
Change of ISO 639-2 language for an audio component																			
<b>Conformity</b>	<input type="checkbox"/> <b>OK</b> <input type="checkbox"/> <b>Fault</b> <input type="checkbox"/> Major <input type="checkbox"/> Minor, define fail reason in comments																		
<b>Comments</b>	<p>If possible describe if fault can be fixed with software update: <input type="checkbox"/> <b>YES</b> <input type="checkbox"/> <b>NO</b></p> <p>Describe more specific faults and/or other information</p>																		
<b>Date</b>	<table border="1"> <tr> <td style="width: 50%;"></td> <td style="width: 10%; text-align: center;"><b>Sign</b></td> <td style="width: 40%;"></td> </tr> </table>		<b>Sign</b>																
	<b>Sign</b>																		

<b>Test Case</b>	<b>Task 15:44 Full service playback – Dynamic update of PMT audio type</b>
<b>Section</b>	NorDig Unified 14.4.5
<b>Requirement</b>	<p>During playback of recorded content the user shall be able to perform the same full service selection as would have been possible during basic live viewing, such as select audio and/or subtitling language (if several components with same type are available), switch subtitling on or off, select audio format etc (with the limitation outlined in section 14.3.9). The basic live viewing refers to all streams excluding any HbbTV related streams. Dynamic changes in the services (such as a change of video aspect ratio or change of audio format) that occur during the recording shall be processed in the same way as during live viewing.</p> <p>During playback the NorDig PVR shall be able to set the same control as during live viewing, for example blanking of video and muting of sound depending on the event's parental rating values (see 14.3.2) and signal protection (HDCP) on its digital output interface (see 9.9.4). For cases where the information is coming from EIT data (like parental rating descriptor), the playback shall at least act on the EIT signalling at the start of the recording (see 15.2.1). For the cases where the information is coming from</p>

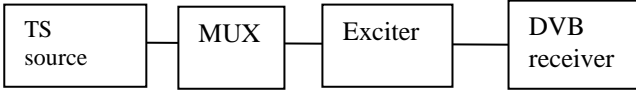
	PMT or the elementary streams (like signal protection and aspect ratio), the playback shall perform the same as live viewing and following any changes therein (i.e. PMT and elementary stream header information shall be stored and processed during playback).										
<b>IRD Profile(s)</b>	Basic, PVR, IRD, FE										
<b>Test procedure</b>	<p><b>Purpose of test:</b> To verify that IRD records all audio tracks. To verify that IRD selects normal/undefined (0x00) audio component by default in playback.</p> <p><b>Equipment:</b></p> <div style="text-align: center;">  <pre> graph LR     TS[TS source] --&gt; MUX[MUX]     MUX --&gt; Exciter[Exciter]     Exciter --&gt; DVB[DVB receiver]             </pre> </div> <p>The TS must contain two services with several audio components for the same language, audio formats and stream type but different audio types.</p> <p>Suitable languages are Swedish, Finnish, Norwegian, Danish, Icelandic, Sami, Irish/Gaelic and English.</p> <p>Audio type is signaled in PMT in one or all of the following descriptors:</p> <ol style="list-style-type: none"> <li>1) Supplementary_audio_descriptor for any stream type.</li> <li>2) AAC_descriptor for AAC audio.</li> <li>3) AC-3 descriptor for AC-3 audio.</li> <li>4) Enhanced AC-3 descriptor for E-AC-3 audio.</li> <li>5) ISO639_descriptor for any stream type.</li> </ol> <p>IRD is assumed to prioritise the audio type signalization information in that order.</p> <p>Audio format is stereo.</p> <p>Stream type for all audio components is either MPEG-4 HE-AAC version 1 or E-AC-3 including metadata corresponding audio_type.</p> <table border="1" style="width: 100%; border-collapse: collapse;"> <thead> <tr> <th style="width: 25%;"></th> <th style="width: 25%;">Service1</th> <th style="width: 25%;">Service2</th> <th style="width: 25%;">Frequency</th> </tr> </thead> <tbody> <tr> <td>MUX TS_id 1 Network_id 1 ON_id <sup>1)</sup></td> <td>SID 1100 S_name Test11 PMT PID 1100 V PID 1109 A PID 1108 ISO639_language_code <sup>2)</sup> Audio_type hearing impaired A PID 1107 ISO639_language_code <sup>2)</sup> Audio_type visual impaired commentary A PID 1106 ISO639_language_code <sup>2)</sup> Audio_type Normal/Undef LCD 1 visible</td> <td>SID 1200 S_name Test12 PMT PID 1200 V PID 1209 A PID 1208 ISO639_language_code <sup>2)</sup> Audio_type hearing impaired A PID 1207 ISO639_language_code <sup>2)</sup> Audio_type visual impaired commentary A PID 1206 ISO639_language_code <sup>2)</sup> Audio_type Normal/Undef LCD 2 visible</td> <td>Can be chosen depending of the distribution media</td> </tr> </tbody> </table> <p>1) ON_id (Original_network_id) can be chosen in range 0x0001-0xfe00 (operational network) and it shall be same for both muxes.</p> <p>2) Language must be same for all audio components and it can be one of the swe/fin/nor/ice/dan/smi/gle/iri/eng/und</p> <p><b>Test procedure:</b></p> <ol style="list-style-type: none"> <li>1. Start recording.</li> <li>2. Verify the receiver selects audio component which has normal/undefined audio by default</li> <li>3. Verify user is able to select different audio components</li> <li>4. Play back the recording.</li> </ol>				Service1	Service2	Frequency	MUX TS_id 1 Network_id 1 ON_id <sup>1)</sup>	SID 1100 S_name Test11 PMT PID 1100 V PID 1109 A PID 1108 ISO639_language_code <sup>2)</sup> Audio_type hearing impaired A PID 1107 ISO639_language_code <sup>2)</sup> Audio_type visual impaired commentary A PID 1106 ISO639_language_code <sup>2)</sup> Audio_type Normal/Undef LCD 1 visible	SID 1200 S_name Test12 PMT PID 1200 V PID 1209 A PID 1208 ISO639_language_code <sup>2)</sup> Audio_type hearing impaired A PID 1207 ISO639_language_code <sup>2)</sup> Audio_type visual impaired commentary A PID 1206 ISO639_language_code <sup>2)</sup> Audio_type Normal/Undef LCD 2 visible	Can be chosen depending of the distribution media
	Service1	Service2	Frequency								
MUX TS_id 1 Network_id 1 ON_id <sup>1)</sup>	SID 1100 S_name Test11 PMT PID 1100 V PID 1109 A PID 1108 ISO639_language_code <sup>2)</sup> Audio_type hearing impaired A PID 1107 ISO639_language_code <sup>2)</sup> Audio_type visual impaired commentary A PID 1106 ISO639_language_code <sup>2)</sup> Audio_type Normal/Undef LCD 1 visible	SID 1200 S_name Test12 PMT PID 1200 V PID 1209 A PID 1208 ISO639_language_code <sup>2)</sup> Audio_type hearing impaired A PID 1207 ISO639_language_code <sup>2)</sup> Audio_type visual impaired commentary A PID 1206 ISO639_language_code <sup>2)</sup> Audio_type Normal/Undef LCD 2 visible	Can be chosen depending of the distribution media								

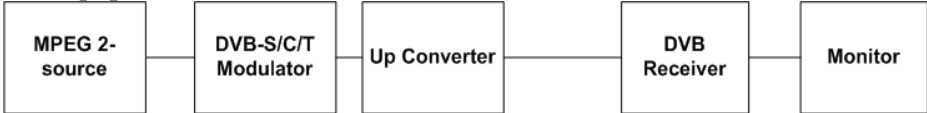

	5. Fill in the measurement record.  <b>Expected result:</b>  IRD selects the audio component that is signalled as Normal/Undefined (0x00) by default when several audio components with the same language code, audio format and stream type but different audio type are available within one service.  The user shall be able to select between the different audio components during playback.						
<b>Test result(s)</b>	Measurement record: <table border="1"> <thead> <tr> <th>Test point</th> <th>Result OK/NOK</th> </tr> </thead> <tbody> <tr> <td>IRD selects normal/undefined audio component by default in playback</td> <td></td> </tr> <tr> <td>All audio components are recorded and selectable during playback</td> <td></td> </tr> </tbody> </table>	Test point	Result OK/NOK	IRD selects normal/undefined audio component by default in playback		All audio components are recorded and selectable during playback	
Test point	Result OK/NOK						
IRD selects normal/undefined audio component by default in playback							
All audio components are recorded and selectable during playback							
<b>Conformity</b>	<input type="checkbox"/> <b>OK Fault</b> <input type="checkbox"/> Major <input type="checkbox"/> Minor, define fail reason in comments						
<b>Comments</b>	If possible describe if fault can be fixed with software update: <input type="checkbox"/> <b>YES</b> <input type="checkbox"/> <b>NO</b> Describe more specific faults and/or other information						
<b>Date</b>	<b>Sign</b>						

<b>Test Case</b>	<b>Task 15:45 Full service playback – Dynamic update of PMT subtitling language</b>														
<b>Section</b>	NorDig Unified 14.4.5														
<b>Requirement</b>	<p>During playback of recorded content the user shall be able to perform the same full service selection as would have been possible during basic live viewing, such as select audio and/or subtitling language (if several components with same type are available), switch subtitling on or off, select audio format etc (with the limitation outlined in section 14.3.9). The basic live viewing refers to all streams excluding any HbbTV related streams. Dynamic changes in the services (such as a change of video aspect ratio or change of audio format) that occur during the recording shall be processed in the same way as during live viewing.</p> <p>During playback the NorDig PVR shall be able to set the same control as during live viewing, for example blanking of video and muting of sound depending on the event's parental rating values (see 14.3.2) and signal protection (HDCP) on its digital output interface (see 9.9.4). For cases where the information is coming from EIT data (like parental rating descriptor), the playback shall at least act on the EIT signalling at the start of the recording (see 15.2.1). For the cases where the information is coming from PMT or the elementary streams (like signal protection and aspect ratio), the playback shall perform the same as live viewing and following any changes therein (i.e. PMT and elementary stream header information shall be stored and processed during playback).</p>														
<b>IRD Profile(s)</b>	Basic, PVR, IRD, FE														
<b>Test procedure</b>	<p><b>Purpose of test:</b> To verify that receiver that the Receiver handles the dynamic update of certain PSI/SI tables.</p> <p><b>Test Equipment:</b></p>  <pre> graph LR     A[MPEG 2-source] --- B[DVB-S/C/T Modulator]     B --- C[Up Converter]     C --- D[DVB Receiver]     D --- E[Monitor]   </pre> <table border="1"> <thead> <tr> <th>MUX1</th> <th>Service1</th> <th>Service2</th> <th>Bouquet SI</th> <th>Can be chosen</th> </tr> </thead> <tbody> <tr> <td>TS_id 1 Network_id 1 ON_id<sup>1)</sup></td> <td>SID 1100 S_name Test11 S_type 0x01</td> <td>SID 1200 S_name Test12 S_type 0x16 or 0x19</td> <td>All information in EIT.</td> <td>depending of the</td> </tr> </tbody> </table>					MUX1	Service1	Service2	Bouquet SI	Can be chosen	TS_id 1 Network_id 1 ON_id <sup>1)</sup>	SID 1100 S_name Test11 S_type 0x01	SID 1200 S_name Test12 S_type 0x16 or 0x19	All information in EIT.	depending of the
MUX1	Service1	Service2	Bouquet SI	Can be chosen											
TS_id 1 Network_id 1 ON_id <sup>1)</sup>	SID 1100 S_name Test11 S_type 0x01	SID 1200 S_name Test12 S_type 0x16 or 0x19	All information in EIT.	depending of the											

	PMT PID 1100 V PID 1109 (MPEG2 SD) A PID 1108 (MPEG1L2) S PID 1107 (DVB subtitling) S PID 1106 (DVB subtitling) LCN 1 visible	PMT PID 1200 V PID 1209 (MPEG4 AVC) A PID 1208 S PID 1107 (DVB subtitling) S PID 1106 (DVB subtitling) LCN 2 visible		distribution media.
<b>MUX2</b> TS_id 2 Network_id 1 ON_id <sup>1)</sup>	<b>Service3</b> SID 2100 S_name Test21 S_type 0x01 PMT PID 1100 V PID 1109 (MPEG2 SD) A PID 1108 (MPEG1L2) S PID 1107 (TTX with multi-lingual subtitling) LCN 3 visible	<b>Service4</b> SID 2200 S_name Test22 S_type 0x16 or 0x19 PMT PID 1200 V PID 1209 (MPEG4 AVC) A PID 1208 S PID 1107 (TTX with multi-lingual subtitling) LCN 4 visible	.	Can be chosen depending of the distribution media.

<sup>1)</sup>ON\_id (Original\_network\_id) can be chosen in range 0x0001-0xfe00 (operational network) and it shall be same for both muxes

Services may contain other components, e.g. teletext, subtitling and multiple additional audio tracks.

PMT of the test services shall be updated during the test so that subtitling components are added and removed in various combinations, e.g. by the following pattern:

S PID a	Lang1			Lang1	
S PID b		Lang2		Lang2	
PMT ver	n	n+1	...	...	n+k
					time

**Test procedure:**

1. Set the user preference for primary subtitling language to Lang1.
2. Set the user preference for secondary subtitling language to other than Lang1 or Lang2.
3. Start recording.
4. Select an another service.
5. Update the PMT table of the service and add/remove subtitling component(s).
6. Stop the recording.
7. Set the user preference for primary subtitling language to other than Lang1 or Lang2 and secondary subtitling language to Lang2.
8. Play back the recording.
9. Fill in the measurement record.

**Expected results:**  
The receiver shall handle updates in PMT and record/playback according to the signaling. All decodable components in PMT have been recorded.  
User preference for primary/secondary subtitling language works correctly in playback.

<b>Test result(s)</b>	Measurement record:	
	<b>Test point</b>	<b>Result OK/NOK</b>
	IRD records all decodable subtitling components in the service	
	User preference for primary/secondary subtitling language works correctly in playback.	
	Subtitling track is selected for playback dynamically by the PMT	
	PMT update and consequent subtitling track selection do not disturb the playback of other components.	

**Conformity**  OK  Fault  Major  Minor, define fail reason in comments

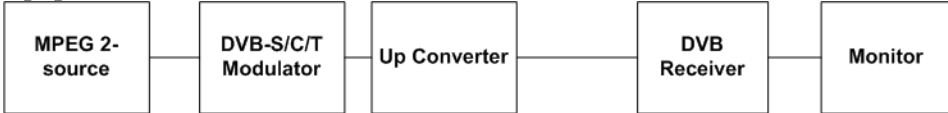

<b>Comments</b>	If possible describe if fault can be fixed with software update: <input type="checkbox"/> YES <input type="checkbox"/> NO Describe more specific faults and/or other information	
<b>Date</b>		<b>Sign</b>

<b>Test Case</b>	<b>Task 15:46 Full service playback – Subtitling for the hard-of-hearing</b>																					
<b>Section</b>	NorDig Unified 14.4.5																					
<b>Requirement</b>	<p>During playback of recorded content the user shall be able to perform the same full service selection as would have been possible during basic live viewing, such as select audio and/or subtitling language (if several components with same type are available), switch subtitling on or off, select audio format etc (with the limitation outlined in section 14.3.9). The basic live viewing refers to all streams excluding any HbbTV related streams. Dynamic changes in the services (such as a change of video aspect ratio or change of audio format) that occur during the recording shall be processed in the same way as during live viewing.</p> <p>During playback the NorDig PVR shall be able to set the same control as during live viewing, for example blanking of video and muting of sound depending on the event’s parental rating values (see 14.3.2) and signal protection (HDCP) on its digital output interface (see 9.9.4). For cases where the information is coming from EIT data (like parental rating descriptor), the playback shall at least act on the EIT signalling at the start of the recording (see 15.2.1). For the cases where the information is coming from PMT or the elementary streams (like signal protection and aspect ratio), the playback shall perform the same as live viewing and following any changes therein (i.e. PMT and elementary stream header information shall be stored and processed during playback).</p>																					
<b>IRD Profile(s)</b>	Basic, PVR, IRD, FE																					
<b>Test procedure</b>	<p><b>Purpose of test:</b></p> <p>To verify that the IRD can handle signalisation and decoding of “hard of hearing” subtitling when they are broadcasted or not during playback. To check that composition pages “normal” are chosen by default instead of “hard of hearing” in playback.</p> <p>Support for ancillary pages is not tested.</p> <p><b>Equipment:</b></p>  <pre> graph LR     A[MPEG 2-source] --- B[DVB-S/C/T Modulator]     B --- C[Up Converter]     C --- D[DVB Receiver]     D --- E[Monitor]   </pre> <p>A transport stream containing test services with DVB and EBU Teletext composition subtitling and “hard of hearing” components.</p> <p>PMT of the test services shall be updated during the test so that subtitling components are added and removed in various combinations, e.g. by the following pattern:</p> <table border="1" style="margin-left: 40px;"> <tr> <td style="padding: 5px;">S PID a</td> <td style="padding: 5px; text-align: center;">Normal</td> <td style="padding: 5px; border-left: 1px dashed black;"></td> <td style="padding: 5px; border-left: 1px dashed black;"></td> <td style="padding: 5px; background-color: #cccccc;"></td> <td style="padding: 5px; text-align: center;">Normal</td> <td style="padding: 5px; background-color: #cccccc;"></td> </tr> <tr> <td style="padding: 5px;">S PID b</td> <td style="padding: 5px; background-color: #cccccc;"></td> <td style="padding: 5px; text-align: center;">HoH</td> <td style="padding: 5px; border-left: 1px dashed black;"></td> <td style="padding: 5px; text-align: center;">HoH</td> <td style="padding: 5px; border-left: 1px dashed black;"></td> <td style="padding: 5px;"></td> </tr> <tr> <td style="padding: 5px;"></td> <td style="padding: 5px; text-align: center;">n</td> <td style="padding: 5px; text-align: center;">n+1</td> <td style="padding: 5px; text-align: center;">...</td> <td style="padding: 5px; text-align: center;">...</td> <td style="padding: 5px; text-align: center;">...</td> <td style="padding: 5px; text-align: center;">n+k</td> </tr> </table> <p style="margin-left: 40px;">time →</p> <p>Subtitling composition pages can be divided into two contents: “normal” or “hard of hearing”. Composition pages shall be enabled in mode “normal” by default. Subtitling ancillary pages can be broadcasted for more or less like a “raw data”. Ancillary pages shall be enabled by default.</p> <p><b>Test procedure:</b></p> <ol style="list-style-type: none"> <li>1. Start recording.</li> </ol>	S PID a	Normal				Normal		S PID b		HoH		HoH				n	n+1	...	...	...	n+k
S PID a	Normal				Normal																	
S PID b		HoH		HoH																		
	n	n+1	...	...	...	n+k																

	<ol style="list-style-type: none"> <li>2. Update the PMT table of the recorded service and add/remove normal and hard-of-hearing subtitling component(s).</li> <li>3. Stop the recording.</li> <li>4. Enable 'hard-of-hearing' subtitling in the user preferences.</li> <li>5. Play back the recording.</li> <li>6. Fill in the measurement record.</li> </ol> <p><b>Expected result:</b> Hard of hearing content of the DVB and EBU Teletext subtitling is recorded, handled, displayed and decoded correctly in playback.</p>										
<b>Test result(s)</b>	<p>Measurement record:</p> <table border="1"> <thead> <tr> <th>Test point</th> <th>Result OK/NOK</th> </tr> </thead> <tbody> <tr> <td>IRD records all decodable subtitling components in the service</td> <td></td> </tr> <tr> <td>Subtitling track is selected for playback dynamically according to the PMT</td> <td></td> </tr> <tr> <td>Hard-of-hearing subtitles are displayed automatically only if selected as the user preference</td> <td></td> </tr> <tr> <td>PMT update and consequent subtitling track selection do not disturb the playback of other components</td> <td></td> </tr> </tbody> </table>	Test point	Result OK/NOK	IRD records all decodable subtitling components in the service		Subtitling track is selected for playback dynamically according to the PMT		Hard-of-hearing subtitles are displayed automatically only if selected as the user preference		PMT update and consequent subtitling track selection do not disturb the playback of other components	
Test point	Result OK/NOK										
IRD records all decodable subtitling components in the service											
Subtitling track is selected for playback dynamically according to the PMT											
Hard-of-hearing subtitles are displayed automatically only if selected as the user preference											
PMT update and consequent subtitling track selection do not disturb the playback of other components											
<b>Conformity</b>	<input type="checkbox"/> <b>OK</b> <input type="checkbox"/> <b>Fault</b> <input type="checkbox"/> Major <input type="checkbox"/> Minor, define fail reason in comments										
<b>Comments</b>	<p>If possible describe if fault can be fixed with software update: <input type="checkbox"/> <b>YES</b> <input type="checkbox"/> <b>NO</b> Describe more specific faults and/or other information</p>										
<b>Date</b>	<table border="1"> <tr> <td style="width: 50%;"></td> <td style="width: 50%; text-align: center;"><i>Sign</i></td> </tr> </table>		<i>Sign</i>								
	<i>Sign</i>										

<b>Test Case</b>	<b>Task 15:47 Full service playback – Dynamic update of PMT subtitling type</b>
<b>Section</b>	NorDig Unified 14.4.5
<b>Requirement</b>	<p>During playback of recorded content the user shall be able to perform the same full service selection as would have been possible during basic live viewing, such as select audio and/or subtitling language (if several components with same type are available), switch subtitling on or off, select audio format etc (with the limitation outlined in section 14.3.9). The basic live viewing refers to all streams excluding any HbbTV related streams. Dynamic changes in the services (such as a change of video aspect ratio or change of audio format) that occur during the recording shall be processed in the same way as during live viewing.</p> <p>During playback the NorDig PVR shall be able to set the same control as during live viewing, for example blanking of video and muting of sound depending on the event's parental rating values (see 14.3.2) and signal protection (HDCP) on its digital output interface (see 9.9.4). For cases where the information is coming from EIT data (like parental rating descriptor), the playback shall at least act on the EIT signalling at the start of the recording (see 15.2.1). For the cases where the information is coming from PMT or the elementary streams (like signal protection and aspect ratio), the playback shall perform the same as live viewing and following any changes therein (i.e. PMT and elementary stream header information shall be stored and processed during playback).</p>
<b>IRD Profile(s)</b>	Basic, PVR, IRD, FE
<b>Test procedure</b>	<p><b>Purpose of test:</b></p> <p>To verify that the IRD prioritizes DVB subtitling over TTX subtitling in playback.</p> <p><b>Equipment:</b></p> <div style="display: flex; align-items: center; justify-content: center; gap: 20px;"> <div style="border: 1px solid black; padding: 5px; text-align: center;">MPEG 2- source</div> <div style="border: 1px solid black; padding: 5px; text-align: center;">DVB-S/C/T Modulator</div> <div style="border: 1px solid black; padding: 5px; text-align: center;">Up Converter</div> <div style="border: 1px solid black; padding: 5px; text-align: center;">DVB Receiver</div> <div style="border: 1px solid black; padding: 5px; text-align: center;">Monitor</div> </div>

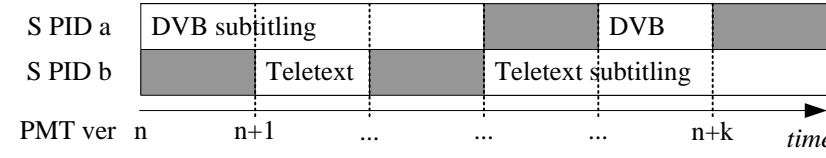
	<p>A transport stream containing test services with DVB and EBU Teletext composition subtitling.</p> <p>PMT of a test service shall be updated during the test so that subtitling components are added and removed in various combinations, e.g. by the following pattern:</p> <div style="text-align: center;">  <p>PMT ver    n            n+1            ...            ...            ...            n+k            time →</p> </div> <p><b>Test procedure:</b></p> <ol style="list-style-type: none"> <li>1. Start recording.</li> <li>2. Update the PMT table of the recorded service and add/remove DVB and EBU Teletext subtitling component(s).</li> <li>3. Stop the recording.</li> <li>4. Start another recording.</li> <li>5. Observe</li> <li>6. Play back the recordings.</li> <li>7. Fill in the measurement record.</li> </ol> <p><b>Expected result:</b> DVB and EBU Teletext subtitling is recorded, handled, displayed and decoded correctly in playback.</p>
--	------------------------------------------------------------------------------------------------------------------------------------------------------------------------------------------------------------------------------------------------------------------------------------------------------------------------------------------------------------------------------------------------------------------------------------------------------------------------------------------------------------------------------------------------------------------------------------------------------------------------------------------------------------------------------------------------------------------------------------------------------------------------------------------------------------------------------------------------------------------------------------------------------------------------------------------------------------------------------------------------------------------------------------------------------------------------

<b>Test result(s)</b>	<p>Measurement record:</p> <table border="1" style="width: 100%;"> <thead> <tr> <th style="width: 80%;">Test point</th> <th style="width: 20%;">Result OK/NOK</th> </tr> </thead> <tbody> <tr> <td>IRD records all decodable subtitling components in the service</td> <td></td> </tr> <tr> <td>Subtitling track is selected for playback dynamically according to the PMT</td> <td></td> </tr> <tr> <td>DVB subtitles are prioritized over EBU Teletext subtitles in playback</td> <td></td> </tr> <tr> <td>Teletext subtitles and DVB subtitles are not displayed simultaneously.</td> <td></td> </tr> </tbody> </table>	Test point	Result OK/NOK	IRD records all decodable subtitling components in the service		Subtitling track is selected for playback dynamically according to the PMT		DVB subtitles are prioritized over EBU Teletext subtitles in playback		Teletext subtitles and DVB subtitles are not displayed simultaneously.	
Test point	Result OK/NOK										
IRD records all decodable subtitling components in the service											
Subtitling track is selected for playback dynamically according to the PMT											
DVB subtitles are prioritized over EBU Teletext subtitles in playback											
Teletext subtitles and DVB subtitles are not displayed simultaneously.											
<b>Conformity</b>	<input type="checkbox"/> OK <input type="checkbox"/> Fault <input type="checkbox"/> Major <input type="checkbox"/> Minor, define fail reason in comments										
<b>Comments</b>	<p>If possible describe if fault can be fixed with software update: <input type="checkbox"/> YES <input type="checkbox"/> NO</p> <p>Describe more specific faults and/or other information</p>										
<b>Date</b>	<table border="1" style="width: 100%;"> <tr> <td style="width: 50%;"></td> <td style="width: 50%; text-align: center;"><i>Sign</i></td> </tr> </table>		<i>Sign</i>								
	<i>Sign</i>										

<b>Test Case</b>	<b>Task 15:48 Full service playback – Subtitling synchronization</b>
<b>Section</b>	NorDig Unified 14.4.5
<b>Requirement</b>	<p>During playback of recorded content the user shall be able to perform the same full service selection as would have been possible during basic live viewing, such as select audio and/or subtitling language (if several components with same type are available), switch subtitling on or off, select audio format etc (with the limitation outlined in section 14.3.9). The basic live viewing refers to all streams excluding any HbbTV related streams. Dynamic changes in the services (such as a change of video aspect ratio or change of audio format) that occur during the recording shall be processed in the same way as during live viewing.</p> <p>During playback the NorDig PVR shall be able to set the same control as during live viewing, for example blanking of video and muting of sound depending on the event's parental rating values (see 14.3.2) and signal protection (HDCP) on its digital output interface (see 9.9.4). For cases where the information is coming from EIT data (like parental rating descriptor), the playback shall at least act on the EIT signalling at the start of the recording (see 15.2.1). For the cases where the information is coming from</p>

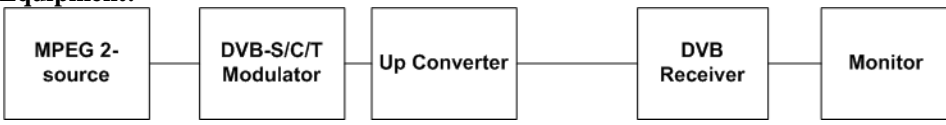
	PMT or the elementary streams (like signal protection and aspect ratio), the playback shall perform the same as live viewing and following any changes therein (i.e. PMT and elementary stream header information shall be stored and processed during playback).										
<b>IRD Profile(s)</b>	Basic, PVR, IRD, FE										
<b>Test procedure</b>	<p><b>Purpose of test:</b></p> <p>To verify that the IRD sustains the subtitling synchronization in playback.</p> <p><b>Equipment:</b></p> <div style="text-align: center;">  <pre> graph LR     A[MPEG 2-source] --&gt; B[DVB-S/C/T Modulator]     B --&gt; C[Up Converter]     C --&gt; D[DVB Receiver]     D --&gt; E[Monitor]             </pre> </div> <p>A transport stream containing test services with DVB and EBU Teletext composition subtitling.</p> <p><b>Test procedure:</b></p> <ol style="list-style-type: none"> <li>1. Start recording.</li> <li>2. Record the content for at least 30 minutes.</li> <li>3. Stop the recording.</li> <li>4. Play back the recording.</li> <li>5. Observe the relative synchronization of subtitling.</li> <li>6. Fill in the measurement record.</li> </ol> <p><b>Expected result:</b></p> <p>DVB and EBU Teletext subtitling is recorded, handled, displayed and decoded correctly in playback.</p>										
<b>Test result(s)</b>	<p>Measurement record:</p> <table border="1" style="width: 100%;"> <thead> <tr> <th style="width: 70%;">Test point</th> <th style="width: 30%;">Result OK/NOK</th> </tr> </thead> <tbody> <tr> <td>DVB subtitling on a SD service is displayed synchronized in playback compared to the live stream</td> <td></td> </tr> <tr> <td>DVB subtitling on a HD service is displayed synchronized in playback compared to the live stream</td> <td></td> </tr> <tr> <td>EBU teletext subtitling on a SD service is displayed synchronized in playback compared to the live stream</td> <td></td> </tr> <tr> <td>EBU teletext subtitling on a HD service is displayed synchronized in playback compared to the live stream</td> <td></td> </tr> </tbody> </table>	Test point	Result OK/NOK	DVB subtitling on a SD service is displayed synchronized in playback compared to the live stream		DVB subtitling on a HD service is displayed synchronized in playback compared to the live stream		EBU teletext subtitling on a SD service is displayed synchronized in playback compared to the live stream		EBU teletext subtitling on a HD service is displayed synchronized in playback compared to the live stream	
Test point	Result OK/NOK										
DVB subtitling on a SD service is displayed synchronized in playback compared to the live stream											
DVB subtitling on a HD service is displayed synchronized in playback compared to the live stream											
EBU teletext subtitling on a SD service is displayed synchronized in playback compared to the live stream											
EBU teletext subtitling on a HD service is displayed synchronized in playback compared to the live stream											
<b>Conformity</b>	<input type="checkbox"/> <b>OK Fault</b> <input type="checkbox"/> Major <input type="checkbox"/> Minor, define fail reason in comments										
<b>Comments</b>	If possible describe if fault can be fixed with software update: <input type="checkbox"/> <b>YES</b> <input type="checkbox"/> <b>NO</b> Describe more specific faults and/or other information										
<b>Date</b>	<input type="text"/> <b>Sign</b> <input type="text"/>										

<b>Test Case</b>	<b>Task 15:49 Full service playback – Subtitling synchronization in time-shift</b>
<b>Section</b>	NorDig Unified 14.4.5
<b>Requirement</b>	<p>During playback of recorded content the user shall be able to perform the same full service selection as would have been possible during basic live viewing, such as select audio and/or subtitling language (if several components with same type are available), switch subtitling on or off, select audio format etc (with the limitation outlined in section 14.3.9). The basic live viewing refers to all streams excluding any HbbTV related streams. Dynamic changes in the services (such as a change of video aspect ratio or change of audio format) that occur during the recording shall be processed in the same way as during live viewing.</p> <p>During playback the NorDig PVR shall be able to set the same control as during live viewing, for example blanking of video and muting of sound depending on the event's</p>

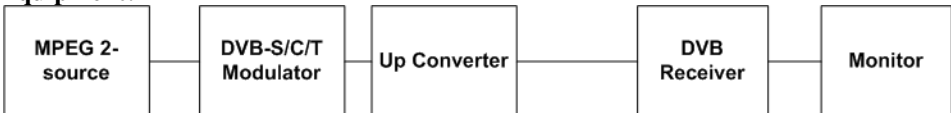
	parental rating values (see 14.3.2) and signal protection (HDCP) on its digital output interface (see 9.9.4). For cases where the information is coming from EIT data (like parental rating descriptor), the playback shall at least act on the EIT signalling at the start of the recording (see 15.2.1). For the cases where the information is coming from PMT or the elementary streams (like signal protection and aspect ratio), the playback shall perform the same as live viewing and following any changes therein (i.e. PMT and elementary stream header information shall be stored and processed during playback).										
<b>IRD Profile(s)</b>	Basic, PVR, IRD, FE										
<b>Test procedure</b>	<p><b>Purpose of test:</b></p> <p>To verify that IRD sustains the subtitling synchronization in time-shift.</p> <p><b>Equipment:</b></p> <div style="text-align: center;">  <pre> graph LR     A[MPEG 2-source] --&gt; B[DVB-S/C/T Modulator]     B --&gt; C[Up Converter]     C --&gt; D[DVB Receiver]     D --&gt; E[Monitor]             </pre> </div> <p>A transport stream containing test services with DVB and EBU Teletext composition subtitling.</p> <p><b>Test procedure:</b></p> <ol style="list-style-type: none"> <li>1. Enable timeshift.</li> <li>2. View the service delayed.</li> <li>3. Observe the relative synchronization of subtitling for at least 15 minutes.</li> <li>4. Fill in the measurement record.</li> </ol> <p><b>Expected result:</b></p> <p>DVB and EBU Teletext subtitling is recorded, handled, displayed and decoded correctly in timeshift.</p>										
<b>Test result(s)</b>	<p>Measurement record:</p> <table border="1"> <thead> <tr> <th>Test point</th> <th>Result OK/NOK</th> </tr> </thead> <tbody> <tr> <td>DVB subtitling on a SD service is displayed synchronized in timeshift mode compared to the live stream</td> <td></td> </tr> <tr> <td>DVB subtitling on a HD service is displayed synchronized in timeshift mode compared to the live stream</td> <td></td> </tr> <tr> <td>EBU teletext subtitling on a SD service is displayed synchronized in timeshift mode compared to the live stream</td> <td></td> </tr> <tr> <td>EBU teletext subtitling on a HD service is displayed synchronized in timeshift mode compared to the live stream</td> <td></td> </tr> </tbody> </table>	Test point	Result OK/NOK	DVB subtitling on a SD service is displayed synchronized in timeshift mode compared to the live stream		DVB subtitling on a HD service is displayed synchronized in timeshift mode compared to the live stream		EBU teletext subtitling on a SD service is displayed synchronized in timeshift mode compared to the live stream		EBU teletext subtitling on a HD service is displayed synchronized in timeshift mode compared to the live stream	
Test point	Result OK/NOK										
DVB subtitling on a SD service is displayed synchronized in timeshift mode compared to the live stream											
DVB subtitling on a HD service is displayed synchronized in timeshift mode compared to the live stream											
EBU teletext subtitling on a SD service is displayed synchronized in timeshift mode compared to the live stream											
EBU teletext subtitling on a HD service is displayed synchronized in timeshift mode compared to the live stream											
<b>Conformity</b>	<input type="checkbox"/> <b>OK</b> <input type="checkbox"/> <b>Fault</b> <input type="checkbox"/> Major <input type="checkbox"/> Minor, define fail reason in comments										
<b>Comments</b>	If possible describe if fault can be fixed with software update: <input type="checkbox"/> <b>YES</b> <input type="checkbox"/> <b>NO</b> Describe more specific faults and/or other information										
<b>Date</b>	<b>Sign</b>										

<b>Test Case</b>	<b>Task 15:50 Full service playback – Dynamic update of PMT video and audio PIDs</b>
<b>Section</b>	NorDig Unified 14.4.5
<b>Requirement</b>	During playback of recorded content the user shall be able to perform the same full service selection as would have been possible during basic live viewing, such as select audio and/or subtitling language (if several components with same type are available), switch subtitling on or off, select audio format etc (with the limitation outlined in section 14.3.9). The basic live viewing refers to all streams excluding any HbbTV related streams. Dynamic changes in the services (such as a change of video aspect ratio or

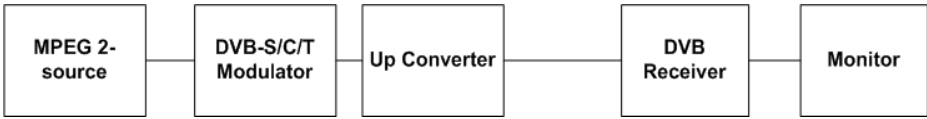
	<p>change of audio format) that occur during the recording shall be processed in the same way as during live viewing.</p> <p>During playback the NorDig PVR shall be able to set the same control as during live viewing, for example blanking of video and muting of sound depending on the event's parental rating values (see 14.3.2) and signal protection (HDCP) on its digital output interface (see 9.9.4). For cases where the information is coming from EIT data (like parental rating descriptor), the playback shall at least act on the EIT signalling at the start of the recording (see 15.2.1). For the cases where the information is coming from PMT or the elementary streams (like signal protection and aspect ratio), the playback shall perform the same as live viewing and following any changes therein (i.e. PMT and elementary stream header information shall be stored and processed during playback).</p>																																							
<p><b>IRD Profile(s)</b></p>	<p>Basic, PVR, IRD, FE</p>																																							
<p><b>Test procedure</b></p>	<p><b>Purpose of test:</b></p> <p>To verify the IRD handles dynamic PMT updates in playback.</p> <p><b>Test equipment:</b></p> <div style="text-align: center;">  <pre> graph LR     A[MPEG 2-source] --- B[DVB-S/C/T Modulator]     B --- C[Up Converter]     C --- D[DVB Receiver]     D --- E[Monitor]             </pre> </div> <table border="1" data-bbox="391 945 1337 1220"> <thead> <tr> <th></th> <th>Service1</th> <th>Service2</th> <th>Frequency</th> </tr> </thead> <tbody> <tr> <td><b>MUX1</b></td> <td>SID 1100</td> <td>SID 1200</td> <td rowspan="2">Can be chosen depending of the distribution media</td> </tr> <tr> <td>TS_id 1</td> <td>S_name Test11</td> <td>S_name Test12</td> </tr> <tr> <td>Network_id 1</td> <td>S_type 0x01, 0x16 or 0x19</td> <td>S_type 0x01, 0x16 or 0x19</td> <td></td> </tr> <tr> <td>ON_id <sup>1)</sup></td> <td>PMT PID 1100</td> <td>PMT PID 1200</td> <td></td> </tr> <tr> <td></td> <td>V PID 1109 incl PCR</td> <td>V PID 1209 incl PCR</td> <td></td> </tr> <tr> <td></td> <td>A PID 1108</td> <td>A PID 1208</td> <td></td> </tr> <tr> <td></td> <td>Teletext PID 1107</td> <td>Teletext PID 1207</td> <td></td> </tr> <tr> <td></td> <td>DVB Subt PID 1106</td> <td>DVB Subt PID 1106</td> <td></td> </tr> <tr> <td></td> <td>LCN1 visible</td> <td>LCN 2 visible</td> <td></td> </tr> </tbody> </table> <p><sup>1)</sup>ON_id (Original_network_id) can be chosen in range 0x0001-0xfe00 (operational network)</p> <p>Sometimes broadcaster may drop, add or change the content of the PID. If this happens, the PMT is updated by changing the version_id.</p> <p>This task can be performed in parallel with Task 13:26 Dynamic update of PMT PID values.</p> <p><b>Test procedure:</b></p> <ol style="list-style-type: none"> <li>1. Drop all PIDs on Service1 on MUX1.</li> <li>2. Select Service1.</li> <li>3. Start recording.</li> <li>4. Add PIDs in following order:             <ol style="list-style-type: none"> <li>a. Video PID 1109</li> <li>b. Audio PID 1108</li> <li>c. Teletext PID1107</li> <li>d. DVB subtitling PID 1106</li> </ol> </li> <li>5. Verify that the service is decoded correctly by watching the video, listening the audio and reading the teletext, teletext subtitling and DVB subtitling</li> <li>6. Change the following PID values:             <ol style="list-style-type: none"> <li>a. Video PID 1109 to 1103</li> <li>b. Audio PID 1108 to 1102</li> </ol> </li> <li>7. Stop recording.</li> <li>8. Play back the recording.</li> <li>9. Fill in the measurement record.</li> </ol>		Service1	Service2	Frequency	<b>MUX1</b>	SID 1100	SID 1200	Can be chosen depending of the distribution media	TS_id 1	S_name Test11	S_name Test12	Network_id 1	S_type 0x01, 0x16 or 0x19	S_type 0x01, 0x16 or 0x19		ON_id <sup>1)</sup>	PMT PID 1100	PMT PID 1200			V PID 1109 incl PCR	V PID 1209 incl PCR			A PID 1108	A PID 1208			Teletext PID 1107	Teletext PID 1207			DVB Subt PID 1106	DVB Subt PID 1106			LCN1 visible	LCN 2 visible	
	Service1	Service2	Frequency																																					
<b>MUX1</b>	SID 1100	SID 1200	Can be chosen depending of the distribution media																																					
TS_id 1	S_name Test11	S_name Test12																																						
Network_id 1	S_type 0x01, 0x16 or 0x19	S_type 0x01, 0x16 or 0x19																																						
ON_id <sup>1)</sup>	PMT PID 1100	PMT PID 1200																																						
	V PID 1109 incl PCR	V PID 1209 incl PCR																																						
	A PID 1108	A PID 1208																																						
	Teletext PID 1107	Teletext PID 1207																																						
	DVB Subt PID 1106	DVB Subt PID 1106																																						
	LCN1 visible	LCN 2 visible																																						

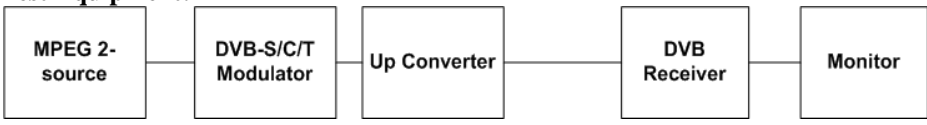

	<p><b>Expected result:</b> After addition or change of the PIDs, all the component in the service are recorded and played back correctly.</p> <p>Change of PID values maintains the service decoding.</p>						
<b>Test result(s)</b>	<p>Measurement record:</p> <table border="1"> <thead> <tr> <th>Test point</th> <th>Result OK/NOK</th> </tr> </thead> <tbody> <tr> <td>IRD handles PMT updates and records all components in PMT</td> <td></td> </tr> <tr> <td>IRD handles PID changes during the recording</td> <td></td> </tr> </tbody> </table>	Test point	Result OK/NOK	IRD handles PMT updates and records all components in PMT		IRD handles PID changes during the recording	
Test point	Result OK/NOK						
IRD handles PMT updates and records all components in PMT							
IRD handles PID changes during the recording							
<b>Conformity</b>	<input type="checkbox"/> <b>OK</b> <input type="checkbox"/> <b>Fault</b> <input type="checkbox"/> Major <input type="checkbox"/> Minor, define fail reason in comments						
<b>Comments</b>	<p>If possible describe if fault can be fixed with software update: <input type="checkbox"/> <b>YES</b> <input type="checkbox"/> <b>NO</b></p> <p>Describe more specific faults and/or other information</p>						
<b>Date</b>	<table border="1"> <tr> <td></td> <td><i>Sign</i></td> <td></td> </tr> </table>		<i>Sign</i>				
	<i>Sign</i>						

<b>Test Case</b>	<b>Task 15:51 Full service playback – Dynamic update of video aspect ratio</b>
<b>Section</b>	NorDig Unified 14.4.5
<b>Requirement</b>	<p>During playback of recorded content the user shall be able to perform the same full service selection as would have been possible during basic live viewing, such as select audio and/or subtitling language (if several components with same type are available), switch subtitling on or off, select audio format etc (with the limitation outlined in section 14.3.9). The basic live viewing refers to all streams excluding any HbbTV related streams. Dynamic changes in the services (such as a change of video aspect ratio or change of audio format) that occur during the recording shall be processed in the same way as during live viewing.</p> <p>During playback the NorDig PVR shall be able to set the same control as during live viewing, for example blanking of video and muting of sound depending on the event’s parental rating values (see 14.3.2) and signal protection (HDCP) on its digital output interface (see 9.9.4). For cases where the information is coming from EIT data (like parental rating descriptor), the playback shall at least act on the EIT signalling at the start of the recording (see 15.2.1). For the cases where the information is coming from PMT or the elementary streams (like signal protection and aspect ratio), the playback shall perform the same as live viewing and following any changes therein (i.e. PMT and elementary stream header information shall be stored and processed during playback).</p>
<b>IRD Profile(s)</b>	Basic, PVR, IRD, FE
<b>Test procedure</b>	<p><b>Purpose of test:</b> To verify that receiver that the Receiver handles the dynamic update of certain PSI/SI tables.</p> <p><b>Test Equipment:</b></p>  <pre> graph LR     A[MPEG 2-source] --&gt; B[DVB-S/C/T Modulator]     B --&gt; C[Up Converter]     C --&gt; D[DVB Receiver]     D --&gt; E[Monitor]   </pre> <p>Test stream or live signal where aspect ratio changes dynamically between 16:9 and 4:3:</p> <ul style="list-style-type: none"> <li>• MPEG-4 AVC HP@L3 576i 25Hz</li> <li>• MPEG-4 AVC HP@L4 720p 50Hz</li> <li>• MPEG-4 AVC HP@L4 1080i 25Hz</li> <li>• MPEG-2 MP@ML 576i 25Hz</li> </ul> <p><b>Test procedure:</b></p>

	<ol style="list-style-type: none"> <li>1. Start recording.</li> <li>2. Update the aspect ratio of the video stream.</li> <li>3. Stop recording</li> <li>4. Play back the recording.</li> <li>5. Verify that the IRD reacts to the aspect ratio change correctly</li> <li>6. Fill in the measurement record.</li> </ol> <p><b>Expected results:</b> The receiver shall handle updates in PMT and record/playback according to the signaling.</p>																		
<i>Test result(s)</i>	<table border="1"> <thead> <tr> <th>Test Point</th> <th>Result OK/NOK</th> </tr> </thead> <tbody> <tr><td>MPEG-4 AVC HP@L3 576i25 16:9 to 4:3</td><td></td></tr> <tr><td>MPEG-4 AVC HP@L3 576i25 4:3 to 16:9</td><td></td></tr> <tr><td>MPEG-4 AVC HP@L4 720p50 16:9 to 4:3</td><td></td></tr> <tr><td>MPEG-4 AVC HP@L4 720p50 4:3 to 16:9</td><td></td></tr> <tr><td>MPEG-4 AVC HP@L4 1080i25 16:9 to 4:3</td><td></td></tr> <tr><td>MPEG-4 AVC HP@L4 1080i25 4:3 to 16:9</td><td></td></tr> <tr><td>MPEG-2 MP@ML 576i25 16:9 to 4:3</td><td></td></tr> <tr><td>MPEG-2 MP@ML 576i25 4:3 to 16:9</td><td></td></tr> </tbody> </table>	Test Point	Result OK/NOK	MPEG-4 AVC HP@L3 576i25 16:9 to 4:3		MPEG-4 AVC HP@L3 576i25 4:3 to 16:9		MPEG-4 AVC HP@L4 720p50 16:9 to 4:3		MPEG-4 AVC HP@L4 720p50 4:3 to 16:9		MPEG-4 AVC HP@L4 1080i25 16:9 to 4:3		MPEG-4 AVC HP@L4 1080i25 4:3 to 16:9		MPEG-2 MP@ML 576i25 16:9 to 4:3		MPEG-2 MP@ML 576i25 4:3 to 16:9	
Test Point	Result OK/NOK																		
MPEG-4 AVC HP@L3 576i25 16:9 to 4:3																			
MPEG-4 AVC HP@L3 576i25 4:3 to 16:9																			
MPEG-4 AVC HP@L4 720p50 16:9 to 4:3																			
MPEG-4 AVC HP@L4 720p50 4:3 to 16:9																			
MPEG-4 AVC HP@L4 1080i25 16:9 to 4:3																			
MPEG-4 AVC HP@L4 1080i25 4:3 to 16:9																			
MPEG-2 MP@ML 576i25 16:9 to 4:3																			
MPEG-2 MP@ML 576i25 4:3 to 16:9																			
<i>Conformity</i>	<input type="checkbox"/> <b>OK Fault</b> <input type="checkbox"/> Major <input type="checkbox"/> Minor, define fail reason in comments																		
<i>Comments</i>	If possible describe if fault can be fixed with software update: <input type="checkbox"/> <b>YES</b> <input type="checkbox"/> <b>NO</b> Describe more specific faults and/or other information																		
<i>Date</i>	<i>Sign</i>																		

<i>Test Case</i>	<b>Task 15:52 Full service playback – Dynamic update of PMT CA status</b>					
<i>Section</i>	NorDig Unified 14.4.5					
<i>Requirement</i>	<p>During playback of recorded content the user shall be able to perform the same full service selection as would have been possible during basic live viewing, such as select audio and/or subtitling language (if several components with same type are available), switch subtitling on or off, select audio format etc (with the limitation outlined in section 14.3.9). The basic live viewing refers to all streams excluding any HbbTV related streams. Dynamic changes in the services (such as a change of video aspect ratio or change of audio format) that occur during the recording shall be processed in the same way as during live viewing.</p> <p>During playback the NorDig PVR shall be able to set the same control as during live viewing, for example blanking of video and muting of sound depending on the event's parental rating values (see 14.3.2) and signal protection (HDCP) on its digital output interface (see 9.9.4). For cases where the information is coming from EIT data (like parental rating descriptor), the playback shall at least act on the EIT signalling at the start of the recording (see 15.2.1). For the cases where the information is coming from PMT or the elementary streams (like signal protection and aspect ratio), the playback shall perform the same as live viewing and following any changes therein (i.e. PMT and elementary stream header information shall be stored and processed during playback).</p>					
<i>IRD Profile(s)</i>	Basic, PVR, IRD, FE					
<i>Test procedure</i>	<p><b>Purpose of test:</b> To verify that receiver that the Receiver handles the dynamic update of certain PSI/SI tables.</p> <p><b>Test Equipment:</b></p> <table border="1" style="width: 100%; text-align: center;"> <tr> <td>MPEG 2- source</td> <td>DVB-S/C/T Modulator</td> <td>Up Converter</td> <td>DVB Receiver</td> <td>Monitor</td> </tr> </table>	MPEG 2- source	DVB-S/C/T Modulator	Up Converter	DVB Receiver	Monitor
MPEG 2- source	DVB-S/C/T Modulator	Up Converter	DVB Receiver	Monitor		

	<p>Live stream or test network with a service that changes from free to scrambled.</p> <p><b>Test procedure:</b></p> <ol style="list-style-type: none"> <li>1. Tune to an unencrypted service that changes from free to scrambled.</li> <li>2. Insert to the IRD a smartcard (and CAM if applicable) with subscription to the service.</li> <li>3. Start recording over the CA status change.</li> <li>4. Verify that IRD continues recording regardless of the CA status change.</li> <li>5. Play back the service with proper CA card.</li> <li>6. Verify that the IRD is able to play back the recording.</li> </ol> <p><b>Expected results:</b> The receiver shall handle updates in PMT and record/playback according to the signaling.</p>
<b>Test result(s)</b>	
<b>Conformity</b>	<input type="checkbox"/> OK Fault <input type="checkbox"/> Major <input type="checkbox"/> Minor, define fail reason in comments
<b>Comments</b>	If possible describe if fault can be fixed with software update: <input type="checkbox"/> YES <input type="checkbox"/> NO Describe more specific faults and/or other information
<b>Date</b>	<b>Sign</b>

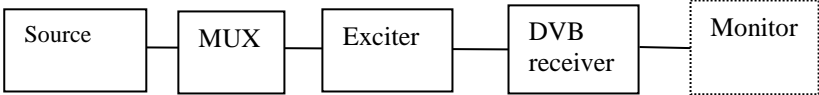
<b>Test Case</b>	<b>Task 15:53 Dynamic changes in video stream in playback</b>
<b>Section</b>	NorDig Unified 14.4.5
<b>Requirement</b>	During playback the NorDig PVR shall be able to set the same control as during live viewing, for example blanking of video and muting of sound depending on the event's parental rating values (see 14.3.2) and signal protection (HDCP) on its digital output interface (see 9.9.4). For cases where the information is coming from EIT data (like parental rating descriptor), the playback shall at least act on the EIT signalling at the start of the recording (see 15.2.1). For the cases where the information is coming from PMT or the elementary streams (like signal protection and aspect ratio), the playback shall perform the same as live viewing and following any changes therein (i.e. PMT and elementary stream header information shall be stored and processed during playback).
<b>IRD Profile(s)</b>	Basic, PVR, IRD, FE
<b>Test procedure</b>	<p><b>Purpose of test:</b> To verify that the receiver is able to handle dynamic changes in transmission between different video modes while recording.</p> <p><b>Equipment:</b></p>  <pre> graph LR     Source[Source] --- MUX[MUX]     MUX --- Exciter[Exciter]     Exciter --- DVB[DVB receiver]     DVB --- Monitor[Monitor]   </pre> <p>This task can be performed in parallel with Task 6:5 Video Decoder - Dynamic changes in video stream.</p> <p>Transport stream containing services with following video content and transitions between them:</p> <ul style="list-style-type: none"> <li>• MPEG-4 AVC HP@L3 576i 25Hz</li> <li>• MPEG-4 AVC HP@L4 720p 50Hz</li> <li>• MPEG-4 AVC HP@L4 1080i 25Hz</li> <li>• MPEG-2 MP@ML 576i 25Hz</li> </ul> <p><b>Test procedure:</b></p>

	<ol style="list-style-type: none"> <li>1. Start recording.</li> <li>2. Perform the required video format transitions.</li> <li>3. Stop recording.</li> <li>4. Verify that changes between modes are happening correctly on playback.</li> <li>5. Fill in the measurement record.</li> </ol> <p><b>Expected result:</b></p> <p>The IRD is able to handle video mode changes during recording and playback.</p>																											
<b>Test result(s)</b>	<p>Measurement record:</p> <table border="1"> <thead> <tr> <th>From</th> <th>To</th> <th>OK/NOK</th> </tr> </thead> <tbody> <tr> <td>MPEG-4 AVC HP@L3 576i 25Hz</td> <td>MPEG-4 AVC HP@L4 720p 50Hz</td> <td></td> </tr> <tr> <td>MPEG-4 AVC HP@L4 720p 50Hz</td> <td>MPEG-4 AVC HP@L3 576i 25Hz</td> <td></td> </tr> <tr> <td>MPEG-4 AVC HP@L4 720p 50Hz</td> <td>MPEG-4 AVC HP@L4 1080i 25Hz</td> <td></td> </tr> <tr> <td>MPEG-4 AVC HP@L4 1080i 25Hz</td> <td>MPEG-4 AVC HP@L4 720p 50Hz</td> <td></td> </tr> <tr> <td>MPEG-4 AVC HP@L4 1080i 25Hz</td> <td>MPEG-4 AVC HP@L3 576i 25Hz</td> <td></td> </tr> <tr> <td>MPEG-4 AVC HP@L3 576i 25Hz</td> <td>MPEG-4 AVC HP@L4 1080i 25Hz</td> <td></td> </tr> <tr> <td>MPEG-2 MP@ML 576i 25Hz</td> <td>MPEG-4 AVC HP@L4 720p 50Hz</td> <td></td> </tr> <tr> <td>MPEG-4 AVC HP@L4 720p 50Hz</td> <td>MPEG-2 MP@ML 576i 25Hz</td> <td></td> </tr> </tbody> </table>	From	To	OK/NOK	MPEG-4 AVC HP@L3 576i 25Hz	MPEG-4 AVC HP@L4 720p 50Hz		MPEG-4 AVC HP@L4 720p 50Hz	MPEG-4 AVC HP@L3 576i 25Hz		MPEG-4 AVC HP@L4 720p 50Hz	MPEG-4 AVC HP@L4 1080i 25Hz		MPEG-4 AVC HP@L4 1080i 25Hz	MPEG-4 AVC HP@L4 720p 50Hz		MPEG-4 AVC HP@L4 1080i 25Hz	MPEG-4 AVC HP@L3 576i 25Hz		MPEG-4 AVC HP@L3 576i 25Hz	MPEG-4 AVC HP@L4 1080i 25Hz		MPEG-2 MP@ML 576i 25Hz	MPEG-4 AVC HP@L4 720p 50Hz		MPEG-4 AVC HP@L4 720p 50Hz	MPEG-2 MP@ML 576i 25Hz	
From	To	OK/NOK																										
MPEG-4 AVC HP@L3 576i 25Hz	MPEG-4 AVC HP@L4 720p 50Hz																											
MPEG-4 AVC HP@L4 720p 50Hz	MPEG-4 AVC HP@L3 576i 25Hz																											
MPEG-4 AVC HP@L4 720p 50Hz	MPEG-4 AVC HP@L4 1080i 25Hz																											
MPEG-4 AVC HP@L4 1080i 25Hz	MPEG-4 AVC HP@L4 720p 50Hz																											
MPEG-4 AVC HP@L4 1080i 25Hz	MPEG-4 AVC HP@L3 576i 25Hz																											
MPEG-4 AVC HP@L3 576i 25Hz	MPEG-4 AVC HP@L4 1080i 25Hz																											
MPEG-2 MP@ML 576i 25Hz	MPEG-4 AVC HP@L4 720p 50Hz																											
MPEG-4 AVC HP@L4 720p 50Hz	MPEG-2 MP@ML 576i 25Hz																											
<b>Conformity</b>	<input type="checkbox"/> <b>OK</b> <input type="checkbox"/> <b>Fault</b> <input type="checkbox"/> Major <input type="checkbox"/> Minor, define fail reason in comments																											
<b>Comments</b>	<p>If possible describe if fault can be fixed with software update: <input type="checkbox"/> <b>YES</b> <input type="checkbox"/> <b>NO</b></p> <p>Describe more specific faults and/or other information</p>																											
<b>Date</b>	<table border="1" style="width: 100%;"> <tr> <td style="width: 50%;"></td> <td style="width: 50%; text-align: center;"><b>Sign</b></td> </tr> </table>		<b>Sign</b>																									
	<b>Sign</b>																											

	<b>Task 15:54 Parental lock during playback</b>
<b>Section</b>	NorDig Unified 14.4.5
<b>Requirement</b>	<p>During playback the NorDig PVR shall be able to set the same control as during live viewing, for example blanking of video and muting of sound depending on the event's parental rating values (see 14.3.2) and signal protection (HDCP) on its digital output interface (see 9.9.4). For cases where the information is coming from EIT data (like parental rating descriptor), the playback shall at least act on the EIT signalling at the start of the recording (see 15.2.1). For the cases where the information is coming from PMT or the elementary streams (like signal protection and aspect ratio), the playback shall perform the same as live viewing and following any changes therein (i.e. PMT and elementary stream header information shall be stored and processed during playback).</p>
<b>IRD Profile(s)</b>	Basic, PVR, IRD, FE
<b>Test procedure</b>	<p><b>Purpose of test:</b></p> <p>To verify that the IRD reacts to dynamic changes in EIT parental rating value also for the recordings.</p> <p><b>Equipment:</b></p> <p>This task can be performed in parallel with Task 13:21 Dynamic update of EIT</p>

	<p>actual/other p/f parental_rating_descriptor</p> <p><b>Test procedure:</b></p> <ol style="list-style-type: none"> <li>1. Choose an arbitrary parental rating value N.</li> <li>2. Set the parental lock value as “disabled” or over N.</li> <li>3. Initiate an OTR over consecutive events having the parental ratings as follows: <table style="margin-left: 40px; border: none;"> <tr> <td style="padding: 0 10px;">No rating</td> <td style="padding: 0 10px;">Rating value N</td> <td style="padding: 0 10px;">No rating</td> <td style="padding: 0 10px;">Rating Value M &lt; N</td> <td style="padding: 0 10px;">No rating</td> </tr> </table> </li> <li>4. Stop the recording.</li> <li>5. Change the IRD parental lock value between M and N.</li> <li>6. Play back the recording.</li> <li>7. Stop the playback.</li> <li>8. Disable the parental lock .</li> <li>9. Play back the recording again.</li> <li>10. Set the parental lock value below M.</li> <li>11. Repeat the steps 2 – 9</li> </ol> <p><b>Expected results:</b> The IRD stores the EIT parental_rating_descriptor value and reacts accordingly during the playback.</p>	No rating	Rating value N	No rating	Rating Value M < N	No rating
No rating	Rating value N	No rating	Rating Value M < N	No rating		
<b>Test result(s)</b>	<p>Measurement record</p> <p><b>Test point</b> <span style="float: right;"><b>Result OK/NOK</b></span> IRD invokes parental lock for a recording that has higher rating in parental_rating_descriptor than the current user preference. Parental lock is not displayed if user preference is higher than the highest rating value in the recording. Parental lock is not displayed if user preference is disabled. EIT Parental rating is interpreted dynamically (optional)</p>					
<b>Conformity</b>	<input type="checkbox"/> <b>OK</b> <input type="checkbox"/> <b>Fault</b> <input type="checkbox"/> Major <input type="checkbox"/> Minor, define fail reason in comments					
<b>Comments</b>	<p>If possible describe if fault can be fixed with software update: <input type="checkbox"/> <b>YES</b> <input type="checkbox"/> <b>NO</b> Describe more specific faults and/or other information</p>					
<b>Date</b>	<b>Sign</b>					

	<b>Task 15:55 Maintaining scheduled recordings after network update</b>
<b>Section</b>	NorDig Unified 14.3.2
<b>Requirement</b>	The NorDig PVR shall make it possible for the user to select individual events and series to be recorded from the ESG or EPG display (based on information from EIT data).
<b>IRD Profile(s)</b>	Basic, PVR, IRD, FE

<b>Test procedure</b>	<p><b>Purpose of test:</b> To verify that network changes do not affect the recording schedule.</p> <p><b>Equipment:</b> This task can be performed in parallel with Task 14:16 Quasi-static update of service list – services moved between different transport streams</p> <p><b>Test procedure:</b></p> <ol style="list-style-type: none"> <li>1. Set up the Task 14:16 initial situation.</li> <li>2. Schedule a recording for service ‘Test12’ after the time event when the IRD quasi-statically reacts to the network changes.  (Example: If the IRD reacts to the network changes always at 03:00, schedule the recording to happen after that time)</li> <li>3. Perform the network change according to Task 14:16.</li> <li>4. Make sure that automatic service list update is initiated.</li> <li>5. Set the IRD to standby.</li> <li>6. Verify that the IRD performs the recording correctly as scheduled in step 2.</li> </ol> <p><b>Expected results:</b> Scheduled recordings are not affected by network changes.</p>
<b>Test result(s)</b>	
<b>Conformity</b>	<input type="checkbox"/> OK <input type="checkbox"/> Fault <input type="checkbox"/> Major <input type="checkbox"/> Minor, define fail reason in comments
<b>Comments</b>	If possible describe if fault can be fixed with software update: <input type="checkbox"/> YES <input type="checkbox"/> NO Describe more specific faults and/or other information
<b>Date</b>	<b>Sign</b>

	<b>Task 15:56 User actions disturbing the recording</b>
<b>Section</b>	NorDig Unified 14.3.2
<b>Requirement</b>	During playback the NorDig PVR shall be able to set the same control as during live viewing, for example blanking of video and muting of sound depending on the event’s parental rating values (see 14.3.2) and signal protection (HDCP) on its digital output interface (see 9.9.4). For cases where the information is coming from EIT data (like parental rating descriptor), the playback shall at least act on the EIT signalling at the start of the recording (see 15.2.1). For the cases where the information is coming from PMT or the elementary streams (like signal protection and aspect ratio), the playback shall perform the same as live viewing and following any changes therein (i.e. PMT and elementary stream header information shall be stored and processed during playback).
<b>IRD Profile(s)</b>	Basic, PVR, IRD, FE
<b>Test procedure</b>	<p><b>Purpose of test:</b> To verify that the PVR IRD is able to handle reception errors gracefully.</p> <p><b>Equipment:</b> Test network</p> <p><b>Test procedure:</b></p> <ol style="list-style-type: none"> <li>1. Initiate a recording.</li> <li>2. Set the IRD to standby for a short time, e.g. 1 minute.</li> <li>3. Wake up the IRD.</li> <li>4. Set the IRD to standby for a longer period of time, e.g. 30 minutes.</li> <li>5. Wake up the IRD.</li> </ol>

	6. Shut down and re-start the HDMI sink (Not applicable for iDTVs). 7. Stop the recording. 8. Initiate a new recording. 9. Power cycle the IRD. 10. Stop the recording, if it is still active. 11. Fill in the measurement record.	
	<b>Expected results:</b> IRD is able to handle the disturbances in the operational environment gracefully.	
<i>Test result(s)</i>	Measurement record	
	<b>Test point</b>	<b>Result OK/NOK</b>
	IRD continues an ongoing recording in stand-by mode	
	HDCP connection status does not disturb the recording.	
	IRD returns back to the originating power state after a power cycle.	
	IRD indicates the recording is incomplete.	
<i>Conformity</i>	<input type="checkbox"/> <b>OK</b> <input type="checkbox"/> <b>Fault</b> <input type="checkbox"/> Major <input type="checkbox"/> Minor, define fail reason in comments	
<i>Comments</i>	If possible describe if fault can be fixed with software update: <input type="checkbox"/> <b>YES</b> <input type="checkbox"/> <b>NO</b> Describe more specific faults and/or other information	
<i>Date</i>	<i>Sign</i>	



## 2.16 Task 16: IRD System Software and API

### 2.16.1 Introduction

This section specifies the test plans related to the NorDig Hybrid IRD.

Verified passing of the latest HbbTV official test suite [3] is a mandatory requirement for all NorDig Hybrid IRD profiles. The implementation of the HbbTV in the NorDig Hybrid IRD shall be verified by the manufacturer, i.e. the verification testing is based on self-testing by the manufacturer unless otherwise specified by the relevant network/Operator.

NorDig broadcast member may request to get a copy of the manufacture's HbbTV Verification Test report with test results, before approving a Hybrid IRD on the market.

Informative: The official HbbTV Test suite of the HbbTV Association (<http://hbbtv.org>) consists of a huge number of test cases, some of which the HbbTV Association has defined as mandatory and some as optional. The optional cases can be referred to as "additional test material". Some of these optional test cases have been contributed by NorDig and some by other testing regimes.

NorDig mandates that NorDig Hybrid IRDs shall pass:

- all test cases that are included in the latest HbbTV test suite and which HbbTV organisation has defined as mandatory
- a number of additional test cases that are included in the latest HbbTV standard test suite but which HbbTV Association has defined as optional/additional test material. These test cases are included in the list of Test Cases below. (Please Note that these test cases might be optional in standard HbbTV Test Suite and in other markets)
- a number of NorDig defined HbbTV test cases which are only included in this NorDig Test Plan.

The current HbbTV Test Suite is available from HbbTV association and it provides a set of test material to test HbbTV device implementations. It is suitable for manufacturers of devices, including hardware and software components implementing the HbbTV specification. For information on how to obtain the HbbTV Test Suite, device manufacturer should refer to <http://hbbtv.org/resource-library/#testing-information-and-support>.

NorDig has contributed into HbbTV organisation with all our NorDig-developed test cases (including test material) and these are available from the HbbTV organisation's Test Repository as "additional test material". It is recommended to use this alternative. For any party who is unable to access the HbbTV Test Repository to obtain the Nordig HbbTV Test Materials, these can be obtained via the Nordig website (<http://www.nordig.org>) as well, free of charge, but subject to accepting the Nordig Test Suite Licence Agreement (available from the Nordig website). The approved Nordig HbbTV Test Suite is identical on both sources.

Running the test cases requires access to the HbbTV Minimum Test Harness, a commercial harness or the Nordig Helper App. The latter is a tool for running the tests and obtaining the results in a meaningful way. Note that the Nordig Helper App enables only the tests designated with «org.nordig» domain to be run.

Please note that currently the Minimum Test Harness is able to run only the tests that are approved to the official HbbTV Test Suite. CI+ test cases are also mandatory to pass as they are approved to the official HbbTV Test Suite. To run the CI+ tests, a test CAM which is compatible with the test harness will be needed. This is likely to either be available through the provider of your commercial test harness, or in the case of the Minimum Test Harness from Eurofins Digital Testing. Please contact [DigitalTestingSupport@eurofins.com](mailto:DigitalTestingSupport@eurofins.com) for assistance in running the CI+ tests in the Minimum Test Harness. The Nordig HbbTV Test Suite includes the materials for tasks 16:1 to 16:59.

National testing regimes, operators and broadcasters define the final requirements for any regional certification process, and these might include additional test suites and test cases (for example DRM tests). Additional test materials are available from the latest release of the HbbTV Test Suite or from the entity organizing the testing regime. The chapter and table 2.16.2. define the test tasks that are by default mandatory to pass to pass the Nordig Test Suite part of any national regime.



Development of the Nordig Test cases is a continuous process and can be tracked in HbbTV Redmine system under the «Nordig API» -group. Redmine system can be reached from <https://hbbtv.org/redmine/projects/nordig-api-group>.

Detailed test task procedures are not repeated here – they can be accessed by referring to the xml test description files and they are visible in the RUT and PC computer screen running the test harness while executing the tests.

### 2.16.2 List of test cases

All NorDig Hybrid IRDs shall in addition to the HbbTV’s mandatory test cases also pass following listed test cases defined within the HbbTV test suite and in the current chapter below:

NorDig Test Task
Test Task
2.16 Task 16: IRD System software and API
Task 16:1 org.nordig_00000010 Current time, TDT/TOT available, NTP available
Task 16:2 org.nordig_00000020 Current time, no TDT/TOT tables, NTP available
Task 16:3 org.nordig_00000030 Current time, no TDT/TOT tables, no NTP, but SNTP is available
Task 16:4 org.nordig_00000100 parental control, blocking application
Task 16:5 org.nordig_00000300 EBU teletext, no HbbTV teletext
Task 16:6 org.nordig_00000310 HbbTV teletext, no EBU teletext
Task 16:7 org.nordig_00000320 EBU teletext and HbbTV teletext
Task 16:8 org.nordig_00000330 EBU Teletext, HbbTV teletext signalled but not available
Task 16:9 org.nordig_00000340 No EBU Teletext, no HbbTV teletext
Task 16:10 org.nordig_00000350 No EBU teletext, HbbTV teletext signalled but not available
Task 16:11 org.nordig_00000400 EBU subtitles over broadband TS, A/V object, no scaling
Task 16:12 org.nordig_00000410 EBU subtitles over broadband TS, A/V object scaled down
Task 16:13 org.nordig_00000420 EBU subtitles over broadband TS, A/V object scaled up
Task 16:14 org.nordig_00000430 DSM-CC stream events and DVB subtitles
Task 16:15 org.nordig_00000440 DSM-CC stream events and EBU subtitles
Task 16:16 org.nordig_00000500 Broadcast video scaling, 1 x 1
Task 16:17 org.nordig_00000510 Broadband TS video scaling, 1 x 1
Task 16:18 org.nordig_00000520 Broadband MP4 video scaling, 1 x 1
Task 16:19 org.nordig_00000600 EIT P/F, characters
Task 16:20 org.nordig_00000610 EIT MetadataSearch, characters
Task 16:21 org.nordig_00001010 Exit button on broadcast independent application: restore broadcast video
Task 16:22 org.nordig_00001020 Exit button: restore broadcast video from PIP mode
Task 16:23 org.nordig_00001050 Setting of preferredUILanguage
Task 16:24 org.nordig_00001060 Updating preferredUILanguage after language change in Navigator
Task 16:25 org.nordig_00001070 Switch subtitles: DVB to EBU teletext
Task 16:26 org.nordig_00001080 Switch subtitles: EBU teletext to DVB
Task 16:27 org.nordig_00001081 Switch subtitles over broadband TS: EBU teletext to DVB
Task 16:28 org.nordig_00001082 Switch subtitles over broadband TS: DVB teletext to EBU
Task 16:29 org.nordig_00001100 Disabling subtitles
Task 16:30 org.nordig_00001101 Disabling subtitles over broadband TS
Task 16:31 org.nordig_00001200 DVB subtitles - V/B Object not bound to current channel
Task 16:32 org.nordig_00001210 DVB subtitles - V/B Object bound to current channel
Task 16:33 org.nordig_00001220 EBU Teletext subtitles: Video/Broadcast Object not bound to current channel
Task 16:34 org.nordig_00001230 EBU Teletext subtitles: Video/Broadcast Object bound to current channel
Task 16:35 org.nordig_00001240 DVB subtitles placed behind application, V/B Object not bound to current channel
Task 16:36 org.nordig_00001250 DVB subtitles placed behind application, V/B Object bound to current channel
Task 16:37 org.nordig_00001260 EBU Teletext subtitles behind application, V/B Object not bound to current channel
Task 16:38 org.nordig_00001270 EBU Teletext subtitles behind application, V/B Object bound to current channel
Task 16:39 org.nordig_00001280 DVB subtitles, V/B object scaled down (1/4 x 1/4)
Task 16:40 org.nordig_00001290 DVB subtitles, V/B object scaled up ( 2 x 2 )
Task 16:41 org.nordig_00001300 DVB subtitles behind application, V/B object scaled down ( 1/4 x 1/4 )
Task 16:42 org.nordig_00001310 DVB subtitles behind application V/B object scaled up ( 2 x 2 )
Task 16:43 org.nordig_00001320 EBU Teletext subtitles, V/B object scaled down (1/4 x 1/4)
Task 16:44 org.nordig_00001330 EBU Teletext subtitles, V/B object scaled up ( 2 x 2 )
Task 16:45 org.nordig_00001340 EBU Teletext subtitles behind application, V/B object scaled down ( 1/4 x 1/4 )
Task 16:46 org.nordig_00001341 EBU Teletext subtitles over broadband TS behind application, A/V object scaled down (1/4x1/4)
Task 16:47 org.nordig_00001350 EBU Teletext subtitles behind application, V/B object scaled up ( 2 x 2 )
Task 16:48 org.nordig_00001400 DVB subtitles, A/V object - no scaling
Task 16:49 org.nordig_00001410 DVB subtitles, A/V object scaled down
Task 16:50 org.nordig_00001420 DVB subtitles, A/V object scaled up ( 2 x 2 )
Task 16:51 HbbTV global setting
Task 16:52 es.tdthibrida_7D7C0040 Broadband DVB subtitles in a TS are displayed
Task 16:53 es.tdthibrida_7D7C0050 Broadband Teletext subtitles in a TS are displayed
Task 16:54 es.tdthibrida_7D7C0060 Broadband Subtitles Below Application Graphics
Task 16:55 fr.hdforum_00151240 EXIT function is provided by receiver
Task 16:56 fr.hdforum_00151250 Termination of autostart application using EXIT function
Task 16:57 fr.hdforum_00151260 Termination of non-autostart broadcast-related application using EXIT function
Task 16:58 es.tdthibrida_7D7C0070 Auto-start applications enabled by default
Task 16:59 fr.hdforum_00151000 Application launching with network connection available
Task 16:60 Teletext - Simultaneous EBU Teletext and HbbTV Digital Teletext (8:6)
Task 16:61 Subtitling - coexistent with HbbTV applications (8:7)
Task 16:62 Remote Control Key event mapping for NorDig Hybrid (9:11)



**2.16.3 Test cases**

<b>Test Case</b>	<b>Task 16:1 – 16:50</b>	
<b>Section</b>	Multiple (see test case descriptions)	
<b>Requirement</b>	Multiple (see test case descriptions)	
<b>IRD Profile(s)</b>	Hybrid	
<b>Test procedure</b>	Purpose of test: See the test case description from the Test Harness / Helper app UI  Equipment: HbbTV Test Harness or NorDig Test Suite helper app  Test procedure: Run the test using the Test Harness or helper app. Follow the on-screen instructions.  Expected result: PASS	
<b>Test result(s)</b>	Test Harness returns PASS [OK] or FAIL [Fault], mark the result below.	
<b>Conformity</b>	<input type="checkbox"/> <b>OK [PASS]</b> <input type="checkbox"/> <b>Fault [NOT OK]</b>	
<b>Comments</b>	If possible describe if fault can be fixed with software update: <input type="checkbox"/> <b>YES</b> <input type="checkbox"/> <b>NO</b> Describe more specific faults and/or other information	
<b>Date</b>		<b>Sign</b>

<b>Test Case</b>	<b>Task 16:51 HbbTV Global setting</b>	
<b>Section</b>	Nordig Unified 15.2	
<b>Requirement</b>	The NorDig Hybrid IRD shall have HbbTV feature as enabled by default (see Section 16.3). It shall have a menu option to allow user to enable / disable the HbbTV feature as a whole and it should have a menu option to allow user to enable / disable the HbbTV feature service by service.	
<b>IRD Profile(s)</b>	Hybrid	
<b>Test procedure</b>	Purpose of test: Verify that the IRD has an option to turn HbbTV on and off globally.  Equipment: IRD under test. Stream with a HbbTV application signalled.  Test procedure: <ol style="list-style-type: none"> <li>1. Turn HbbTV setting OFF</li> <li>2. Check that HbbTV application is not launched.</li> <li>3. Turn HbbTV setting ON</li> <li>4. Check that HbbTV application is launched.</li> </ol> Expected result: PASS	
<b>Test result(s)</b>	[OK] or FAIL [Fault], mark the result below.	
<b>Conformity</b>	<input type="checkbox"/> <b>OK</b> <input type="checkbox"/> <b>Fault</b> <input type="checkbox"/> Major <input type="checkbox"/> Minor, define fail reason in comments	
<b>Comments</b>	If possible describe if fault can be fixed with software update: <input type="checkbox"/> <b>YES</b> <input type="checkbox"/> <b>NO</b> Describe more specific faults and/or other information	
<b>Date</b>		<b>Sign</b>

<b>Test Case</b>	<b>Task 16:52 – 16:59 (es.TDThibrida and fr.HDFForum tests)</b>	
<b>Section</b>	Multiple (see test case descriptions)	
<b>Requirement</b>	Multiple (see test case descriptions)	
<b>IRD Profile(s)</b>	Hybrid	
<b>Test procedure</b>	<p>Purpose of test: See the test case description from the Test Harness.</p> <p>Equipment: HbbTV Test Harness.</p> <p>Test procedure: Run the test using the Test Harness. Follow the on-screen instructions.</p> <p>Expected result: PASS</p>	
<b>Test result(s)</b>	Test Harness returns PASS [OK] or FAIL [Fault], mark the result below.	
<b>Conformity</b>	<input type="checkbox"/> OK [PASS] <input type="checkbox"/> Fault [NOT OK]	
<b>Comments</b>	If possible describe if fault can be fixed with software update: <input type="checkbox"/> YES <input type="checkbox"/> NO Describe more specific faults and/or other information	
<b>Date</b>		<b>Sign</b>

<b>Test Case</b>	<b>Task 16:60 Teletext - Simultaneous EBU Teletext and HbbTV Digital Teletext (8:6)</b>	
<b>Section</b>	NorDig Unified 7.1.6	
<b>Requirement</b>	<p>For services that have both an EBU Teletext service and an HbbTV Digital Teletext application signaled and available, the NorDig Hybrid shall (1) be able to start and display the HbbTV Digital Teletext application as well as being able to start and display the EBU Teletext service (one at a time).</p> <p>The NorDig Hybrid shall (1) start teletext and be able to toggle between any HbbTV Digital Teletext and any EBU Teletext service as described in clause 5.3.4 of HbbTV specification ETSI TS 102 796.</p>	
<b>IRD Profile(s)</b>	Hybrid	
<b>Test procedure</b>	<p><b>Purpose of test:</b> To verify that the IRD is able to start EBU Teletext and HbbTV Digital Teletext (one at the time). A transport stream containing a test services with EBU Teletext and HbbTV Digital Teletext application is required.</p> <p><b>Test procedure:</b> 1. Tune to a serve that contains both EBU Teletext and HbbTV Digital Teletext application. 2. Verify that the user can toggle between EBU Teletext and HbbTV Digital Teletext application by pressing the “text” button in the RCU.</p> <p><b>Expected result:</b> User can toggle between EBU Teletext and HbbTV Digital Teletext application.</p>	
<b>Test result(s)</b>	[OK] or FAIL [Fault], mark the result below.	
<b>Conformity</b>	<input type="checkbox"/> OK <input type="checkbox"/> Fault <input type="checkbox"/> Major <input type="checkbox"/> Minor, define fail reason in comments	
<b>Comments</b>	If possible describe if fault can be fixed with software update: <input type="checkbox"/> YES <input type="checkbox"/> NO Describe more specific faults and/or other information	

<i>Date</i>		<i>Sign</i>	

<i>Test Case</i>	<b>Task 16:61 Subtitling - coexistent with HbbTV applications (8:7)</b>
<i>Section</i>	NorDig Unified 7.1.7
<i>Requirement</i>	<p>A NorDig Hybrid shall support simultaneous display of HbbTV application and subtitles (DVB subtitling and EBU teletext subtitling), both for broadcast and at least for MPEG2 TS delivered via broadband [29].</p> <p>The NorDig Hybrid shall display the HbbTV application over the subtitles as described in clause 10.1.1 of HbbTV specification ETSI TS 102 796 [30]. This means that if the video is up or down-converted, to other than full screen video, the subtitles shall either be rescaled/repositioned appropriately or not displayed at all.</p>
<i>IRD Profile(s)</i>	Hybrid
<i>Test procedure</i>	<p><b>Purpose of test:</b> To verify that DVB and EBU teletext subtitling can coexists with HbbTV applications.</p> <p>A transport stream containing a test service with DVB and EBU teletext composition subtitling component and at least one signaled service bound HbbTV application at the same channel.</p> <p><b>Test procedure:</b></p> <ol style="list-style-type: none"> <li>1. set the IRD to the autostart mode for the HbbTV services and ensure that subtitles are enabled</li> <li>2. search channels</li> <li>3. zap to a channel that contains the HbbTV service and subtitles</li> <li>4. verify that when the HbbTV application is not using the same graphics plane or area of the plane as the subtitles, the subtitles are visible</li> </ol> <p><b>Expected result:</b> The subtitles are visible with a HbbTV application, when they are not sharing the same area of the graphics plane.</p>
<i>Test result(s)</i>	[OK] or FAIL [Fault], mark the result below.
<i>Conformity</i>	<input type="checkbox"/> OK <input type="checkbox"/> Fault <input type="checkbox"/> Major <input type="checkbox"/> Minor, define fail reason in comments
<i>Comments</i>	If possible describe if fault can be fixed with software update: <input type="checkbox"/> YES <input type="checkbox"/> NO Describe more specific faults and/or other information
<i>Date</i>	<i>Sign</i>

<i>Test Case</i>	<b>Task 16:62 Remote Control Key event mapping for NorDig Hybrid (9:11)</b>
<i>Section</i>	NorDig 8.7.2.6
<i>Requirement</i>	The NorDig Hybrid IRD shall generate (HbbTV) events according to Table 8.3 when a key is pressed on the NorDig IRD remote control.
<i>IRD Profile(s)</i>	Hybrid
<i>Test procedure</i>	<p><b>Test procedure:</b> Check the manufacturer technical specification / compliance list or verify the remote control functions.</p> <p><b>Expected result:</b> The minimum hardware requirement is fulfilled.</p>
<i>Test result(s)</i>	[OK] or FAIL [Fault], mark the result below.



**NorDig**

<i>Conformity</i>	<input type="checkbox"/> <b>OK Fault</b> <input type="checkbox"/> Major <input type="checkbox"/> Minor, define fail reason in comments		
<i>Comments</i>	If possible describe if fault can be fixed with software update: <input type="checkbox"/> <b>YES</b> <input type="checkbox"/> <b>NO</b> Describe more specific faults and/or other information		
<i>Date</i>		<i>Sign</i>	

### 2.17 Task 17: User Preferences

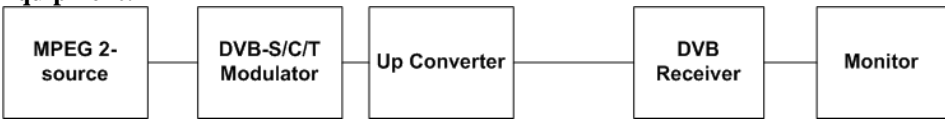
<b>Test Case</b>	<b>Task 17:1 Stored preferences</b>	
<b>Section</b>	NorDig Unified 16.1 and 16.2	
<b>Requirement</b>	The user shall be able to store preference settings in persistent memory. All user preference settings listed below shall remain when changing service and when re-starting the IRD. The following user preferences shall be implemented in the NorDig IRD, unless it is stated below as optional (should) requirement. (See section 16.4 for factory default values).	
<b>IRD Profile(s)</b>	Basic, IRD, FE	
<b>Test procedure</b>	<p><b>Purpose of test:</b> To verify stored user preferences</p> <p><b>Equipment:</b></p>  <pre> graph LR     A[MPEG 2-source] --- B[DVB-S/C/T Modulator]     B --- C[Up Converter]     C --- D[DVB Receiver]     D --- E[Monitor]     </pre> <p><b>Test procedure:</b></p> <ol style="list-style-type: none"> <li>Verify following user preferences: <ul style="list-style-type: none"> <li>* Service list</li> <li>* Country settings</li> <li>* Talking menus/Text-to-speech</li> <li>* SSU settings</li> <li>* HbbTV settings</li> <li>* HDCP preferences (Optional)</li> <li>* Video display preferences</li> <li>* Audio preferences</li> <li>* Primary and secondary audio language preferences</li> <li>* Primary and secondary subtitling language preferences</li> <li>* Service list preferences</li> <li>* Country settings preferences</li> <li>* Audio transcoding preferences</li> <li>* HDMI preferences</li> <li>* Supplementary Audio settings</li> </ul> </li> </ol> <p><b>Expected result:</b> User preferences are as defined.</p>	
<b>Test result(s)</b>		
<b>Conformity</b>	<input type="checkbox"/> <b>OK</b> <input type="checkbox"/> <b>Fault</b> <input type="checkbox"/> Major <input type="checkbox"/> Minor, define fail reason in comments	
<b>Comments</b>	If possible describe if fault can be fixed with software update: <input type="checkbox"/> <b>YES</b> <input type="checkbox"/> <b>NO</b> Describe more specific faults and/or other information	
<b>Date</b>		<b>Sign</b>

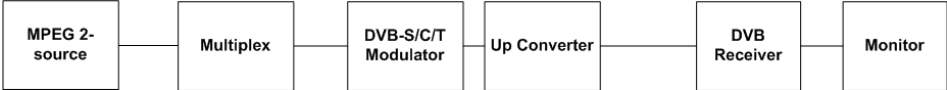
<b>Test Case</b>	<b>Task 17:2 Deletion of service lists</b>	
<b>Section</b>	NorDig Unified 16.3	
<b>Requirement</b>	The IRD shall provide a function to remove all service lists (default and user defined) and should not affecting other parameters (e.g. user preferences).	
<b>IRD Profile(s)</b>	Basic, IRD, FE	
<b>Test procedure</b>	<p><b>Purpose of test:</b> To verify deletion of the service lists</p> <p><b>Equipment:</b></p>  <pre> graph LR     A[MPEG 2-source] --- B[Multiplex]     B --- C[DVB-S/C/T Modulator]     C --- D[Up Converter]     D --- E[DVB Receiver]     E --- F[Monitor] </pre> <p><b>Test procedure:</b></p> <ol style="list-style-type: none"> <li>1. Verify if the receiver supports a mechanism to only remove service lists.</li> <li>2. Verify that the service list(s) exists</li> <li>3. Remove service list(s)</li> <li>4. Verify remove of the service list(s)</li> </ol> <p><b>Expected result:</b> Service lists are removed.</p>	
<b>Test result(s)</b>		
<b>Conformity</b>	<input type="checkbox"/> OK <input type="checkbox"/> Fault <input type="checkbox"/> Major <input type="checkbox"/> Minor, define fail reason in comments	
<b>Comments</b>	If possible describe if fault can be fixed with software update: <input type="checkbox"/> YES <input type="checkbox"/> NO Describe more specific faults and/or other information	
<b>Date</b>		<b>Sign</b>

<b>Test Case</b>	<b>Task 17:3 Reset to factory mode</b>	
<b>Section</b>	NorDig Unified 16.4	
<b>Requirement</b>	The IRD shall provide a function to reset all parameters to factory mode, thus removing all service lists, user preferences, etc. After reset, the IRD shall enter installation state.	
<b>IRD Profile(s)</b>	Basic, IRD, FE	
<b>Test procedure</b>	<p><b>Purpose of test:</b> To verify the reset function.</p> <p><b>Equipment:</b></p> <p><b>Test procedure:</b></p> <ol style="list-style-type: none"> <li>1. Locate the reset to factory mode function in the IRD and initiate it.</li> <li>2. Check that the service list and user preferences have been deleted.</li> <li>3. Enter the navigator and check that the factory mode meets the requirements.</li> <li>4. Fill in the test protocol.</li> </ol> <p><b>Expected result:</b> The IRD has the user preference settings according the requirements.</p>	
<b>Test result(s)</b>	Test protocol	

	<b>Requirement</b>	<b>Value</b>	<b>NOK or OK</b>
	RF input DC power supply source for satellite front-end:	on	
	RF input DC power supply source for terrestrial front-end:	off (1)	
	RF-output preset channel:	Channel 43 (PAL-G) (2)	
	RF bypass gain	Disabled	
	Menu language:	equal to country settings	
	Audio (normal)	On	
	Primary audio language:	equal to country settings	
	Audio format setting:	Stereo	
	Audio; hard of hearing/hearing impaired:	Off	
	Subtitling (normal):	on	
	Primary subtitling language:	as country settings	
	Subtitling; hard of hearing/hearing impaired:	off	
	HbbTV Interactivity	On	
	HDMI Audio output	Automatic using EDID information	
	HDMI Video output	Automatic using EDID information	
	HDCP	ON or as specified by the relevant network/ CA operator see section 9.11.4 (1)	
	SSU – mode	Semi-automatic (if supported, otherwise a mode that enables automatic search)	
	PVR recording priority, SD vs HD	HD	
	Talking menus (Text-to-Speech), optional	Off	
<b>Conformity</b>	<input type="checkbox"/> <b>OK Fault</b> <input type="checkbox"/> Major <input type="checkbox"/> Minor, define fail reason in comments		
<b>Comments</b>	If possible describe if fault can be fixed with software update: <input type="checkbox"/> <b>YES</b> <input type="checkbox"/> <b>NO</b> Describe more specific faults and/or other information		
<b>Date</b>		<b>Sign</b>	



## AnnexA: NorDig Network Custodians

The NorDig Network Custodians are represented (per June 17th, 2008) by the following companies in the Nordic countries and relevant networks:

Country/Network	Contact information
<b>Denmark</b>	
Cable Networks	To be defined
Satellite Networks	To be defined
Terrestrial Network	To be defined
<b>Finland</b>	
Cable Networks	<b>Labwise Oy</b> (test laboratory) Tel. +358 3 214 0010 Email: <a href="mailto:testing@labwise.fi">testing@labwise.fi</a> Web: <a href="http://www.kaapelitelevisio.fi">www.kaapelitelevisio.fi</a> or <a href="http://www.labwise.fi">www.labwise.fi</a>
Satellite Networks	To be defined
Terrestrial Networks	<b>Labwise Oy</b> (test laboratory) Tel. +358 3 214 0010 Email: <a href="mailto:testing@labwise.fi">testing@labwise.fi</a> Web: <a href="http://www.labwise.fi">www.labwise.fi</a>
<b>Iceland</b>	
Cable Networks	To be defined
Satellite Networks	To be defined
Terrestrial Networks	To be defined
<b>Norway</b>	
Cable Networks	To be defined
Satellite Networks	<b>Telenor Broadcast Holding AS / Canal Digital Technology &amp; IS</b> Tel. Email: Web:
Terrestrial Networks	To be defined
<b>Sweden</b>	
Cable Networks	To be defined
Satellite Networks	To be defined
Terrestrial Networks	<b>Receivers for pay TV services:</b> <b>Boxer TV Access AB</b> (operator) Tel: +46 8 587 899 00 (switchboard) Email: <a href="mailto:irdtest@boxer.se">irdtest@boxer.se</a> Web: <a href="http://www.boxer.se">www.boxer.se</a>  <b>Any other type of receivers; e.g. professional, OEM, free-to-view, reference designs:</b> <b>TeracomAB</b> (network operator) Tel: +46 8 555 420 00 (switchboard) Email: <a href="mailto:irdtest@teracom.se">irdtest@teracom.se</a> Web: <a href="http://www.teracom.se">www.teracom.se</a>